



**THE DATASHEET OF
SG-531P 20.0000MC**



MS2201

RF & MICROWAVE TRANSISTORS AVIONICS APPLICATIONS

Features

- 1025-1150 MHz
- GOLD METALLIZATION
- INFINITE VSWR CAPABILITY @ RATED CONDITIONS
- Pout = 2 W MINIMUM
- G_p = 9 dB

DESCRIPTION:

The MS2201 is a silicon NPN, Class C microwave transistor designed for Class C driver applications under DME or IFF pulse conditions. This device is capable of withstanding an infinite load VSWR at any phase angle under rated conditions.

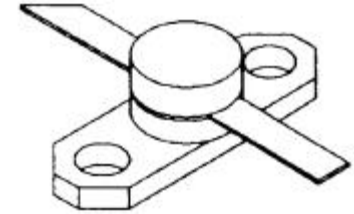

**.280 2LFL M220
epoxy sealed**

PIN CONNECTION

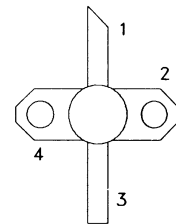

1. Collector 3. Emitter
2. Base 4. Base

ABSOLUTE MAXIMUM RATINGS (T_{case} = 25°C)

Symbol	Parameter	Value	Unit
P _{DISS}	Power Dissipation	10	W
V _{CC}	Collector-Supply Voltage	37	V
T _J	Junction Temperature	200	°C
I _C	Device Current	250	mA
T _{STG}	Storage Temperature	-65 to +200	°C

Thermal Data

R _{TH(J-C)}	Junction-case Thermal Resistance*	10	°C/W
----------------------	-----------------------------------	----	------

ELECTRICAL SPECIFICATIONS (T_{case} = 25°C)
STATIC

Symbol	Test Conditions	Value			Unit
		Min.	Typ.	Max.	
BV_{CBO}	I_C = 1 mA I_E = 0 mA	45	---	---	V
BV_{CER}	I_C = 5 mA R_{BE} = 10Ω	45	---	---	V
BV_{EBO}	I_E = 1 mA I_C = 0 mA	3.5	---	---	V
I_{CES}	V_{CE} = 35 V	---	---	1.0	mA
HFE	V_{CE} = 5 V I_C = 100 mA	30	---	300	---

DYNAMIC

Symbol	Test Conditions	Value			Unit
		Min.	Typ.	Max.	
P_{OUT}	f = 1025 - 1150 MHz P_{IN} = 250mW V_{CE} = 35V	2	---	---	W
η_C	f = 1025 - 1150 MHz P_{IN} = 250mW V_{CE} = 35V	35	---	---	%
G_P	f = 1025 - 1150 MHz P_{IN} = 250mW V_{CE} = 35V	9	---	---	dB

Conditions: Pulse Width = 10 μs Duty Cycle = 1%

TYPICAL PERFORMANCE

BROADBAND POWER AMPLIFIER

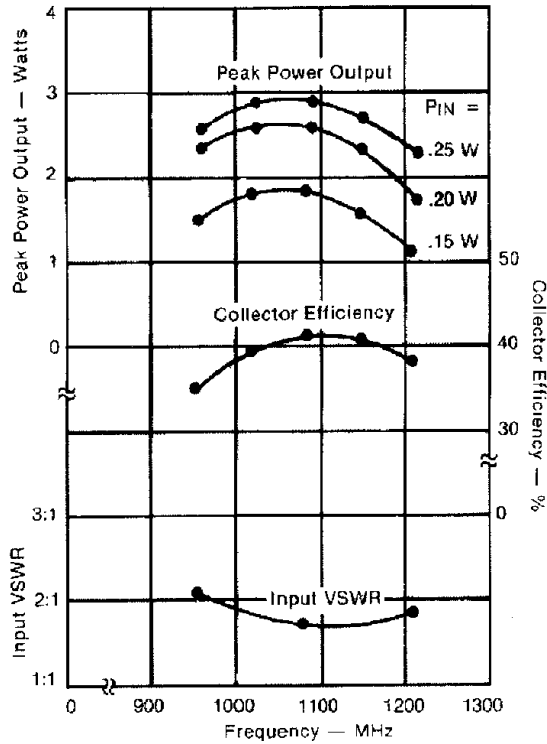

NARROWBAND PEAK POWER OUTPUT vs FREQUENCY

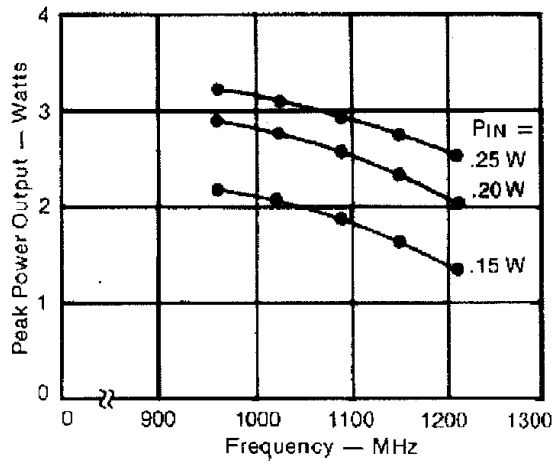

NARROWBAND COLLECTOR EFFICIENCY vs FREQUENCY

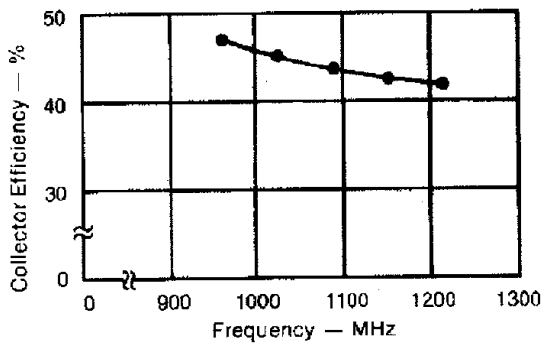

RELATIVE PEAK POWER OUTPUT & COLLECTOR EFFICIENCY vs COLLECTOR VOLTAGE

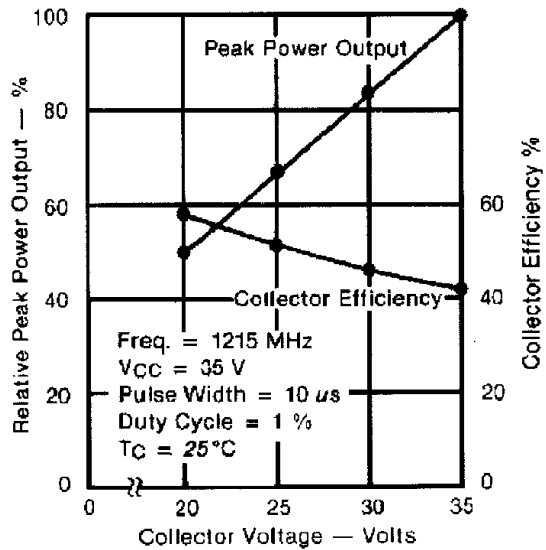

TEST CIRCUIT

Ref.: Dwg. No. C127298

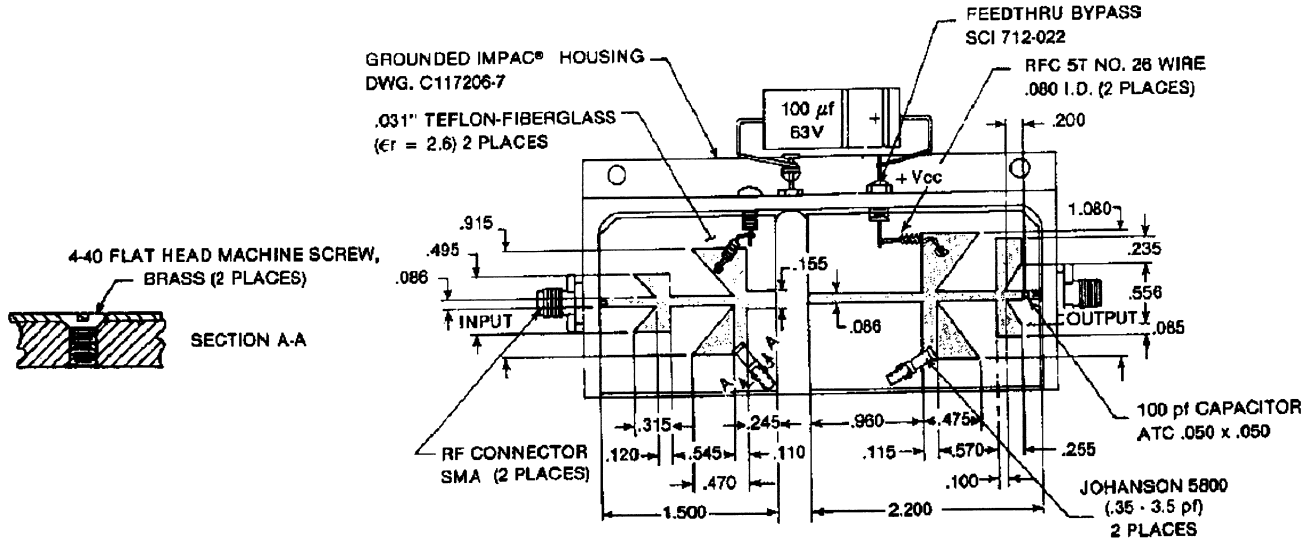

All dimensions are in inches.

PACKAGE MECHANICAL DATA

PACKAGE STYLE M220

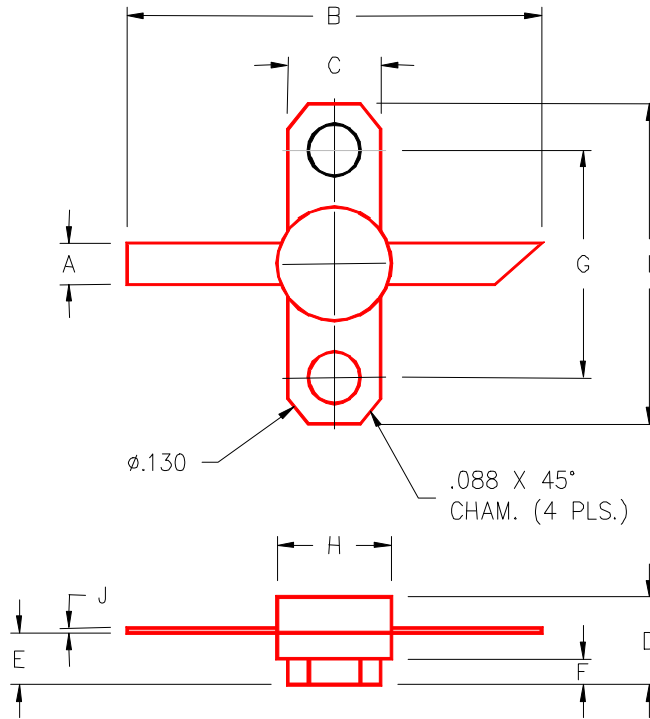

	MINIMUM INCHES/MM	MAXIMUM INCHES/MM		MINIMUM INCHES/MM	MAXIMUM INCHES/MM
A	.100/2,54		J	.003/0,08	.006/0,15
B	1.050/26,67				
C	.250/6,35				
D		.210/5,33			
E	.120/3,05	.130/3,30			
F	.062/1,58				
G	.562/14,28				
H		.285/7,24			
I	.800/20,32				

Looking for pricing, stock, or lifecycle information?

Click below to explore more details on WIN SOURCE:

- ⊖ [View SG-531P 20.0000MC on WIN SOURCE](#)
- ⊖ [Epson Company Information](#)

Optimize Your Supply Chain with WIN SOURCE Solutions

- ✓ Global Sourcing Solution
- ✓ Obsolete Management
- ✓ Cost Control Management
- ✓ Shortage Management
- ✓ Alternative Solution
- ✓ Excess Inventory Management