



**THE DATASHEET OF
TZ600N16KOFHPSA1**



**Key Parameters**

V_{DRM} / V_{RRM}	1200V - 1600V
I_{TAVM}	600A ($T_C=85^\circ\text{C}$)
I_{TSM}	17000A
V_{TO}	0,9V
r_T	0,27m Ω
R_{thJC}	0,062K/W
Base plate	50mm



For type designation please refer to actual short form catalog

<http://www.ifbip.com/catalog>

Merkmale

- Druckkontakt-Technologie für hohe Zuverlässigkeit
- Industrie-Standard-Gehäuse
- Elektrisch isolierte Bodenplatte

Features

- Pressure contact technology for high reliability
- Industrial standard package
- Electrically insulated base plate

Typische Anwendungen

- Sanftanlasser
- Gleichrichter für Antriebsapplikationen
- Kurzschließer-Applikationen
- Leistungssteller
- Gleichrichter für UPS
- Batterieladegleichrichter
- Statische Umschalter
- Bypass-Schalter

Typical Applications

- Soft starter
- Rectifier for drives applications
- Crowbar applications
- Power controllers
- Rectifiers for UBS
- Battery chargers
- Static switches
- Bypass switch

content of customer DMX code	DMX code digit	DMX code digit quantity
serial number	1..5	5
SAP material number	6..12	7
Internal production order number	13..20	8
datecode (production year)	21..22	2
datecode (production week)	23..24	2

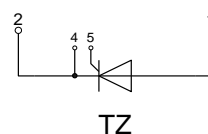

www.ifbip.com
support@infineon-bip.com



TZ600N

Elektrische Eigenschaften / Electrical properties

Höchstzulässige Werte / Maximum rated values

Periodische Vorwärts- und Rückwärts-Spitzensperrspannung repetitive peak forward off-state and reverse voltages	$T_{vj} = -40^{\circ}\text{C} \dots T_{vj\text{ max}}$	$V_{\text{DRM}}, V_{\text{RRM}}$	1200 1400 1600	V V
Vorwärts-Stoßspitzensperrspannung non-repetitive peak forward off-state voltage	$T_{vj} = -40^{\circ}\text{C} \dots T_{vj\text{ max}}$	V_{DSM}	1200 1400 1600	V V
Rückwärts-Stoßspitzensperrspannung non-repetitive peak reverse voltage	$T_{vj} = +25^{\circ}\text{C} \dots T_{vj\text{ max}}$	V_{RSM}	1300 1500 1700	V
Durchlaßstrom-Grenzeffektivwert maximum RMS on-state current		I_{TRMSM}	1050	A
Dauergrenzstrom average on-state current	$T_{\text{C}} = 85^{\circ}\text{C}$ $T_{\text{C}} = 77^{\circ}\text{C}$	I_{TAVM}	600 669	A A
Stoßstrom-Grenzwert surge current	$T_{vj} = 25^{\circ}\text{C}, t_{\text{p}} = 10\text{ ms}$ $T_{vj} = T_{vj\text{ max}}, t_{\text{p}} = 10\text{ ms}$	I_{TSM}	17.000 14.000	A A
Grenzlastintegral I^2t -value	$T_{vj} = 25^{\circ}\text{C}, t_{\text{p}} = 10\text{ ms}$ $T_{vj} = T_{vj\text{ max}}, t_{\text{p}} = 10\text{ ms}$	I^2t	1.445.000 980.000	A^2s A^2s
Kritische Stromsteilheit critical rate of rise of on-state current	DIN IEC 747-6 $f = 50\text{ Hz}, i_{\text{GM}} = 1\text{ A}, di_{\text{G}}/dt = 1\text{ A}/\mu\text{s}$	$(di_{\text{T}}/dt)_{\text{cr}}$	200	$\text{A}/\mu\text{s}$
Kritische Spannungssteilheit critical rate of rise of off-state voltage	$T_{vj} = T_{vj\text{ max}}, V_{\text{D}} = 0,67 V_{\text{DRM}}$ 6.Kennbuchstabe / 6 th letter F	$(dv_{\text{D}}/dt)_{\text{cr}}$	1000	$\text{V}/\mu\text{s}$

Charakteristische Werte / Characteristic values

Durchlaßspannung on-state voltage	$T_{vj} = T_{vj\text{ max}}, i_{\text{T}} = 1700\text{ A}$	v_{T}	max. 1,53	V
Schleusenspannung threshold voltage	$T_{vj} = T_{vj\text{ max}}$	$V_{(\text{TO})}$	0,9	V
Ersatzwiderstand slope resistance	$T_{vj} = T_{vj\text{ max}}$	r_{T}	0,27	$\text{m}\Omega$
Zündstrom gate trigger current	$T_{vj} = 25^{\circ}\text{C}, V_{\text{D}} = 6\text{ V}$	I_{GT}	max. 250	mA
Zündspannung gate trigger voltage	$T_{vj} = 25^{\circ}\text{C}, V_{\text{D}} = 6\text{ V}$	V_{GT}	max. 2,2	V
Nicht zündender Steuerstrom gate non-trigger current	$T_{vj} = T_{vj\text{ max}}, V_{\text{D}} = 6\text{ V}$ $T_{vj} = T_{vj\text{ max}}, V_{\text{D}} = 0,5 V_{\text{DRM}}$	I_{GD}	max. 10 max. 5	mA mA
Nicht zündende Steuerspannung gate non-trigger voltage	$T_{vj} = T_{vj\text{ max}}, V_{\text{D}} = 0,5 V_{\text{DRM}}$	V_{GD}	max. 0,25	V
Haltestrom holding current	$T_{vj} = 25^{\circ}\text{C}, V_{\text{D}} = 6\text{ V}, R_{\text{A}} = 5\ \Omega$	I_{H}	max. 300	mA
Einraststrom latching current	$T_{vj} = 25^{\circ}\text{C}, V_{\text{D}} = 6\text{ V}, R_{\text{GK}} \geq 10\ \Omega$ $i_{\text{GM}} = 1\text{ A}, di_{\text{G}}/dt = 1\text{ A}/\mu\text{s}, t_{\text{g}} = 20\ \mu\text{s}$	I_{L}	max. 1500	mA
Vorwärts- und Rückwärts-Sperrstrom forward off-state and reverse current	$T_{vj} = T_{vj\text{ max}}$ $V_{\text{D}} = V_{\text{DRM}}, V_{\text{R}} = V_{\text{RRM}}$	$i_{\text{D}}, i_{\text{R}}$	max. 140	mA
Zündverzug gate controlled delay time	DIN IEC 747-6 $T_{vj} = 25^{\circ}\text{C}, i_{\text{GM}} = 1\text{ A}, di_{\text{G}}/dt = 1\text{ A}/\mu\text{s}$	t_{gd}	max. 4	μs

prepared by: A. Glunz	date of publication: 2018.07.16
approved by: M. Stelle	revision: 3.4

**Elektrische Eigenschaften / Electrical properties**

Charakteristische Werte / Characteristic values

Freiwerdezeit circuit commutated turn-off time	$T_{vj} = T_{vj\max}$, $i_{TM} = I_{TAVM}$ $V_{RM} = 100\text{ V}$, $V_{DM} = 0,67 V_{DRM}$ $dv_D/dt = 20\text{ V}/\mu\text{s}$, $-di_T/dt = 10\text{ A}/\mu\text{s}$ 5.Kennbuchstabe / 5 th letter O	t_q	typ.	250	μs
Isolations-Prüfspannung insulation test voltage	RMS, $f = 50\text{ Hz}$, $t = 1\text{ min}$ RMS, $f = 50\text{ Hz}$, $t = 1\text{ sec}$	V_{ISOL}		3,0 3,6	kV kV

Thermische Eigenschaften / Thermal properties

Innerer Wärmewiderstand thermal resistance, junction to case	pro Modul / per Module, $\Theta = 180^\circ\text{ sin}$ pro Modul / per Module, DC	R_{thJC}	max.	0,065	$^\circ\text{C}/\text{W}$
			max.	0,062	$^\circ\text{C}/\text{W}$
Übergangs-Wärmewiderstand thermal resistance, case to heatsink	pro Modul / per Module	R_{thCH}	max.	0,02	$^\circ\text{C}/\text{W}$
Höchstzulässige Sperrschichttemperatur maximum junction temperature		$T_{vj\max}$		135	$^\circ\text{C}$
Betriebstemperatur operating temperature		$T_{c\text{ op}}$		-40...+135	$^\circ\text{C}$
Lagertemperatur storage temperature		T_{stg}		-40...+140	$^\circ\text{C}$

Mechanische Eigenschaften / Mechanical properties

Gehäuse, siehe Anlage case, see annex				Seite 4 page 4	
Si-Element mit Druckkontakt Si-pellet with pressure contact					
Innere Isolation internal insulation				AIN	
Anzugsdrehmoment für mechanische Anschlüsse mounting torque	Toleranz / Tolerance $\pm 15\%$	M1		5	Nm
Anzugsdrehmoment für elektrische Anschlüsse terminal connection torque	Toleranz / Tolerance $\pm 10\%$	M2		12	Nm
Steueranschlüsse control terminals	DIN 46 244			A 2,8 x 0,8	
Gewicht weight		G	typ.	900	g
Kriechstrecke creepage distance				15	mm
Schwingfestigkeit vibration resistance	$f = 50\text{ Hz}$			50	m/s^2
	file-No.			E 83335	

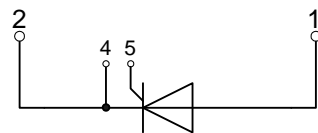
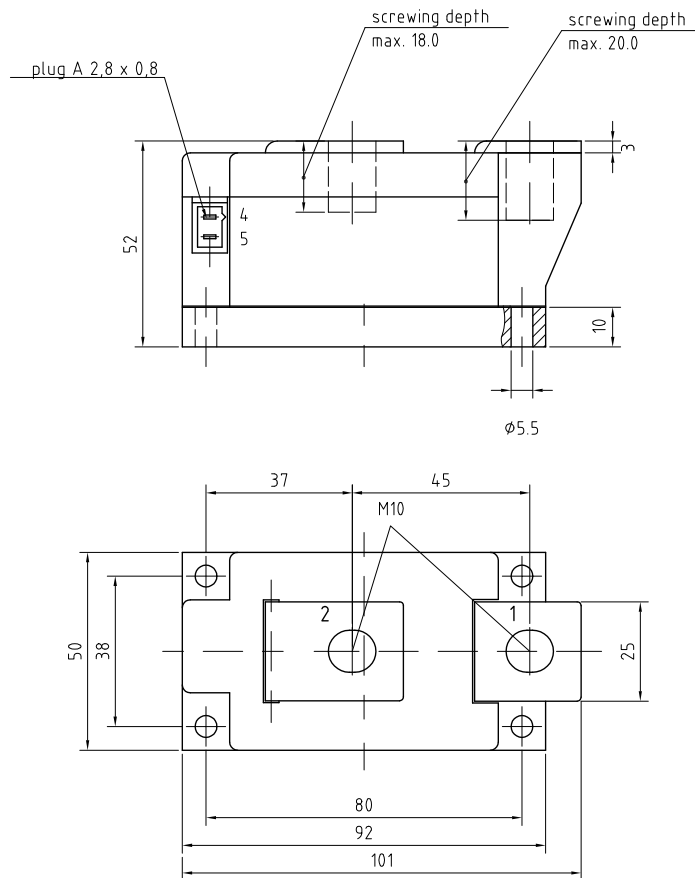
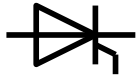

TZ

**Analytische Elemente des transienten Wärmewiderstandes Z_{thJC} für DC**
Analytical elements of transient thermal impedance Z_{thJC} for DC

Pos. n	1	2	3	4	5	6	7
R_{thn} [°C/W]	0,00137	0,00486	0,0114	0,0223	0,0221		
τ_n [s]	0,00076	0,0086	0,101	0,56	3,12		

Analytische Funktion / Analytical function:
$$Z_{thJC} = \sum_{n=1}^{n_{max}} R_{thn} \left(1 - e^{-\frac{t}{\tau_n}} \right)$$

Luftselbstkühlung / Natural cooling
3 Module pro Kühlkörper / 3 modules per heatsink
Kühlkörper / Heatsink type: KM17 (90W)

Analytische Elemente des transienten Wärmewiderstandes Z_{thCA}
Analytical elements of transient thermal impedance Z_{thCA}

Pos. n	1	2	3	4	5	6	7
R_{thn} [°C/W]	0,796	0,005	0,041				
τ_n [s]	1420	912	12				

Verstärkte Kühlung / Forced cooling
3 Module pro Kühlkörper / 3 modules per heatsink
Kühlkörper / Heatsink type: KM17 (Papst 4650N)

Analytische Elemente des transienten Wärmewiderstandes Z_{thCA}
Analytical elements of transient thermal impedance Z_{thCA}

Pos. n	1	2	3	4	5	6	7
R_{thn} [°C/W]	0,239	0,0435	0,0075				
τ_n [s]	497	31,8	6,4				

Analytische Funktion / Analytical function:
$$Z_{thCA} = \sum_{n=1}^{n_{max}} R_{thn} \left(1 - e^{-\frac{t}{\tau_n}} \right)$$

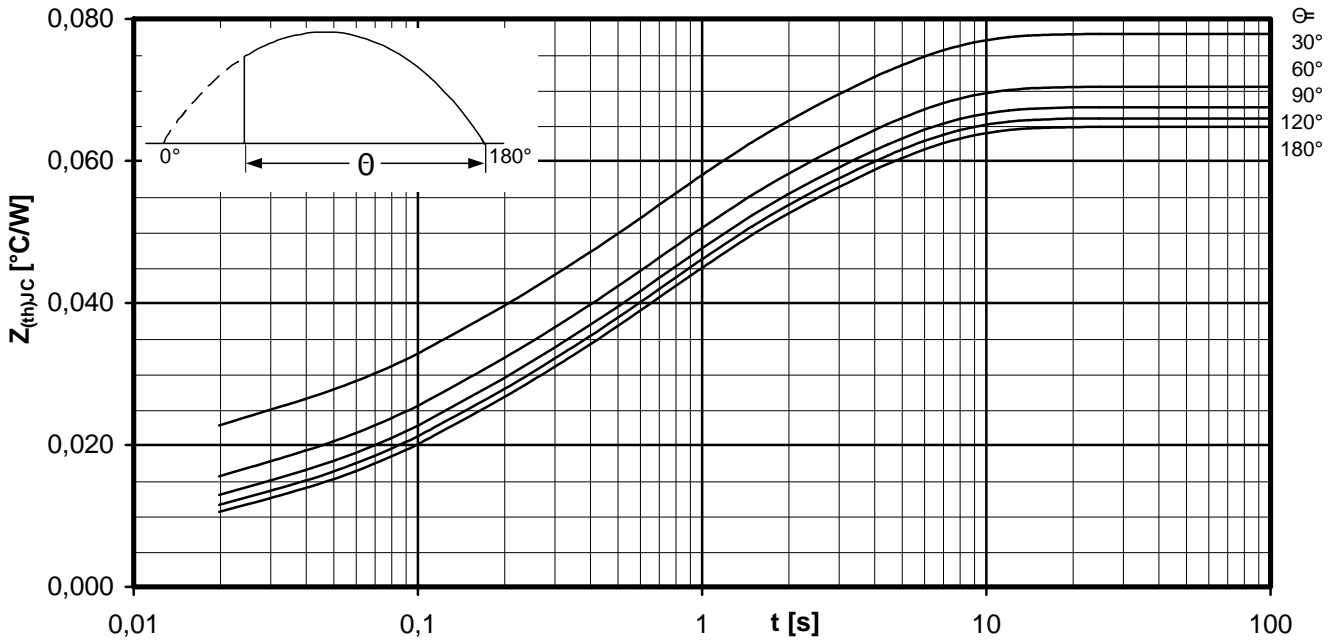

Transienter innerer Wärmewiderstand je Zweig / Transient thermal impedance per arm $Z_{thJC} = f(t)$

Sinusförmiger Strom / Sinusoidal current

Parameter: Stromflußwinkel Θ / Current conduction angle Θ

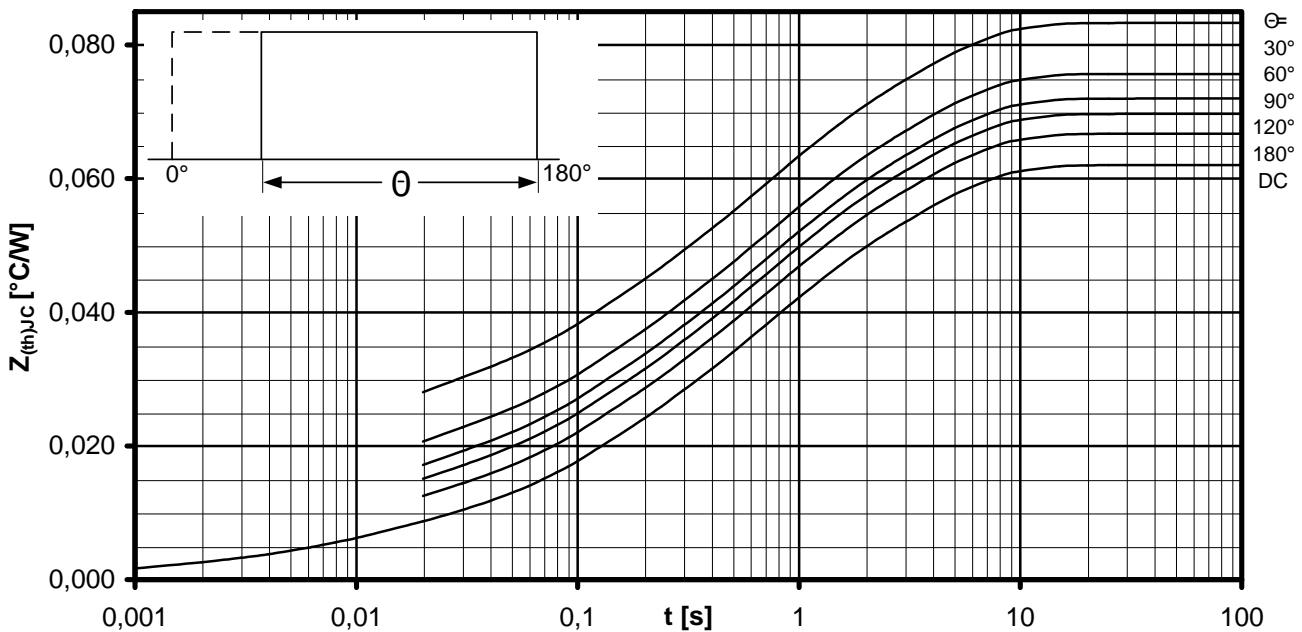

Transienter innerer Wärmewiderstand je Zweig / Transient thermal impedance per arm $Z_{thJC} = f(t)$

Rechteckförmiger Strom / Rectangular current

Parameter: Stromflußwinkel Θ / Current conduction angle Θ

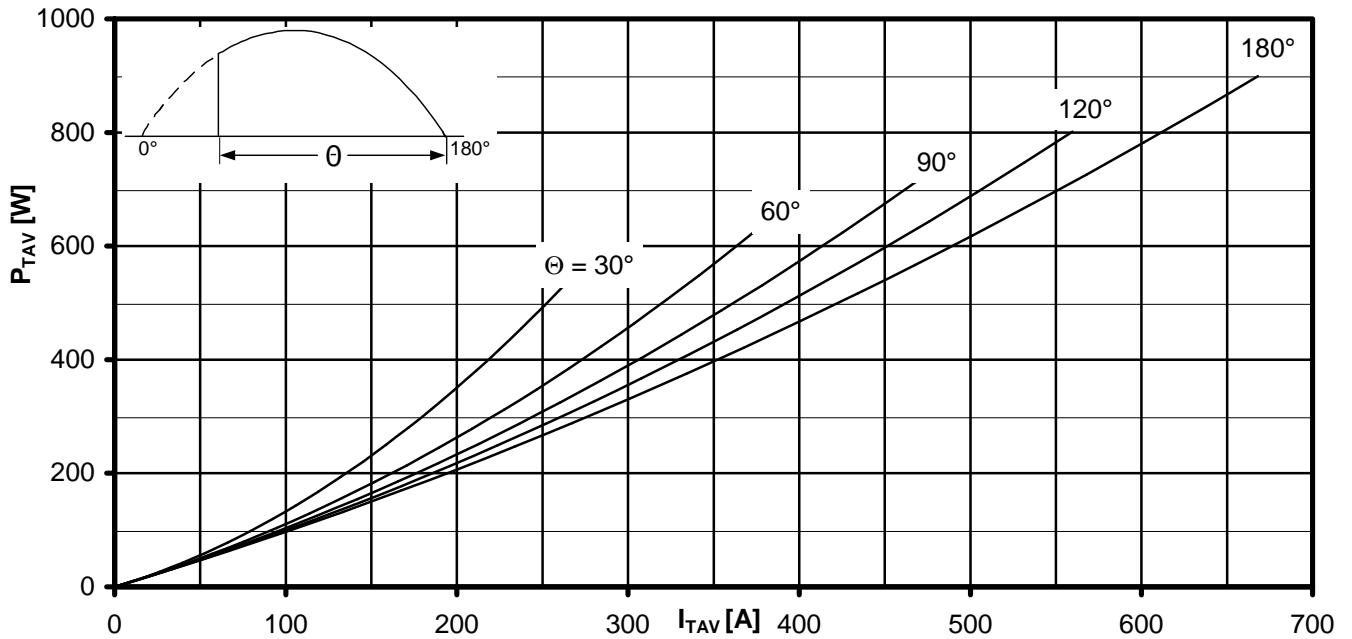

Durchlassverlustleistung je Zweig / On-state power loss per arm $P_{TAV} = f(I_{TAV})$

Sinusförmiger Strom / Sinusoidal current Strombelastung je Zweig / Current load per arm

Parameter: Stromflußwinkel / Current conduction angle Θ

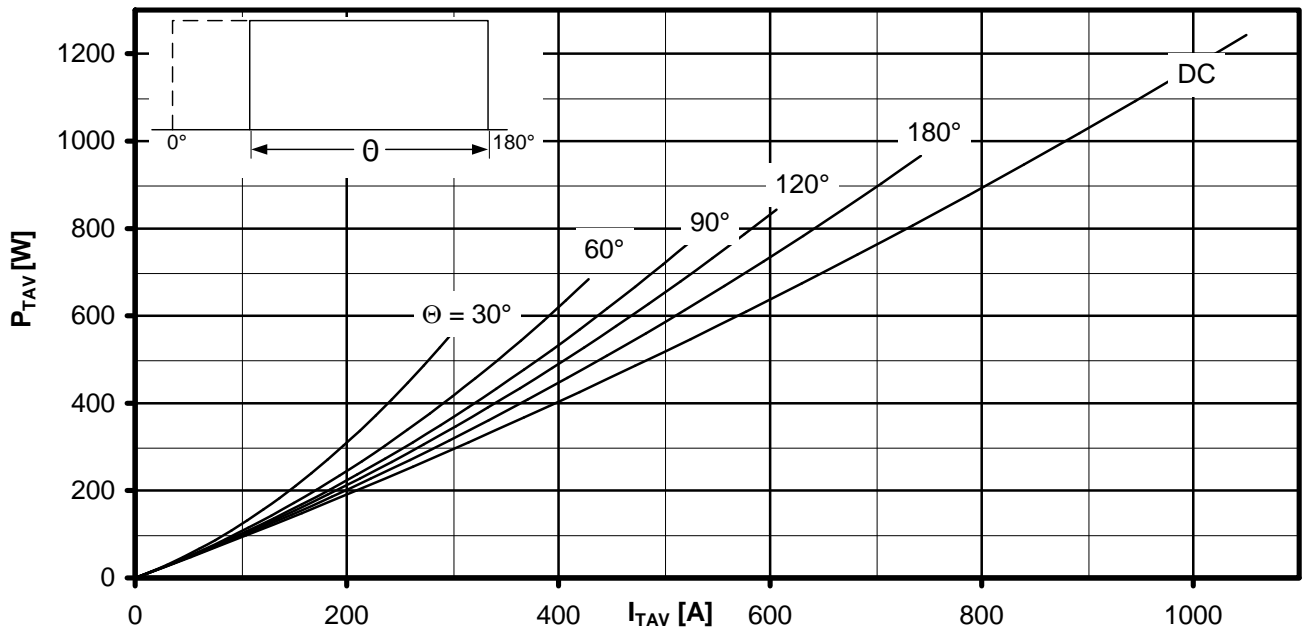

Durchlassverlustleistung je Zweig / On-state power loss per arm $P_{TAV} = f(I_{TAV})$

Rechteckförmiger Strom / Rectangular current Strombelastung je Zweig / Current load per arm

Parameter: Stromflußwinkel / Current conduction angle Θ

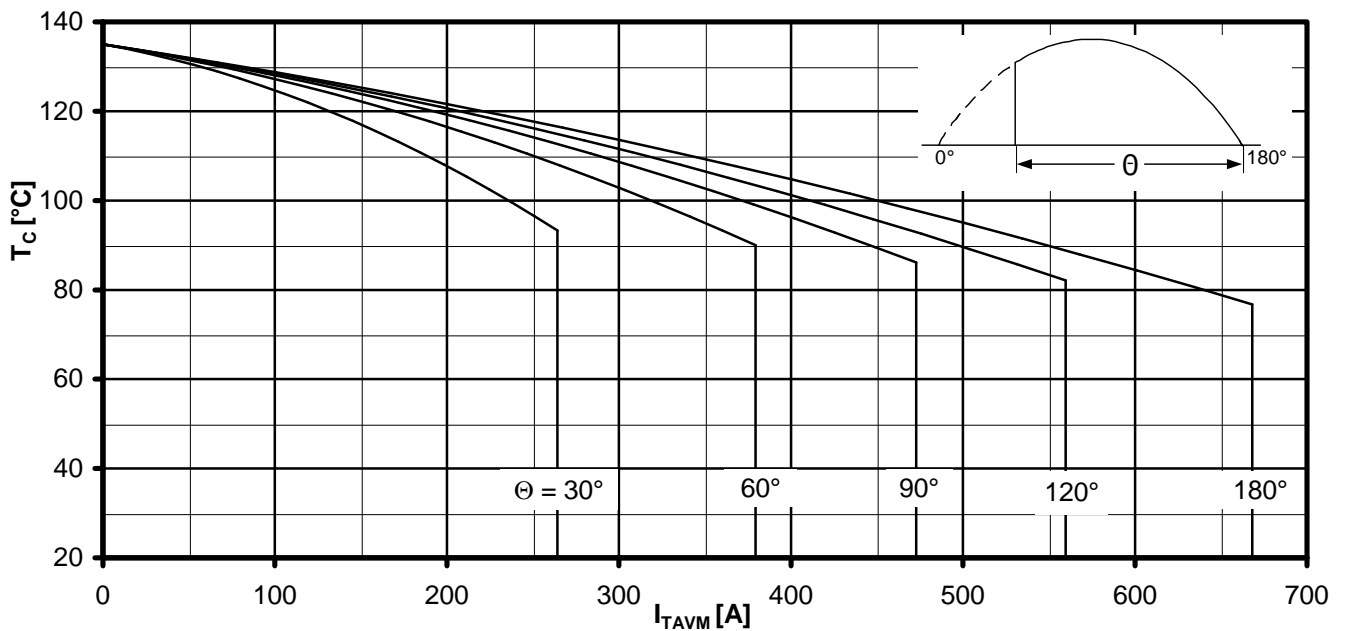
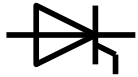

Höchstzulässige Gehäusetemperatur / Maximum allowable case temperature $T_C = f(I_{TAVM})$

Sinusförmiger Strom / Sinusoidal current Strombelastung je Zweig / Current load per arm

Parameter: Stromflußwinkel Θ / Current conduction angle Θ

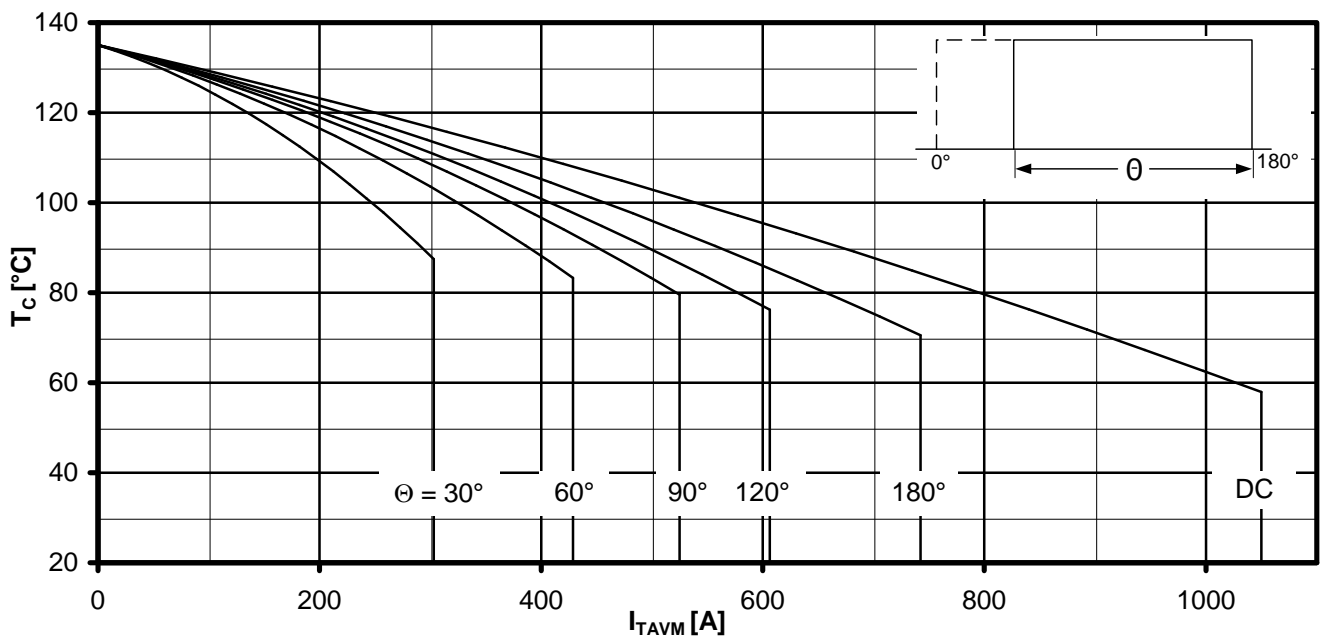

Höchstzulässige Gehäusetemperatur / Maximum allowable case temperature $T_C = f(I_{TAVM})$

Rechteckförmiger Strom / Rectangular current Strombelastung je Zweig / Current load per arm

Parameter: Stromflußwinkel Θ / Current conduction angle Θ

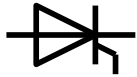

Netz-Thyristor-Modul
Phase Control Thyristor Module

TZ600N

Infineon Technologies Bipolar
GmbH & Co. KG

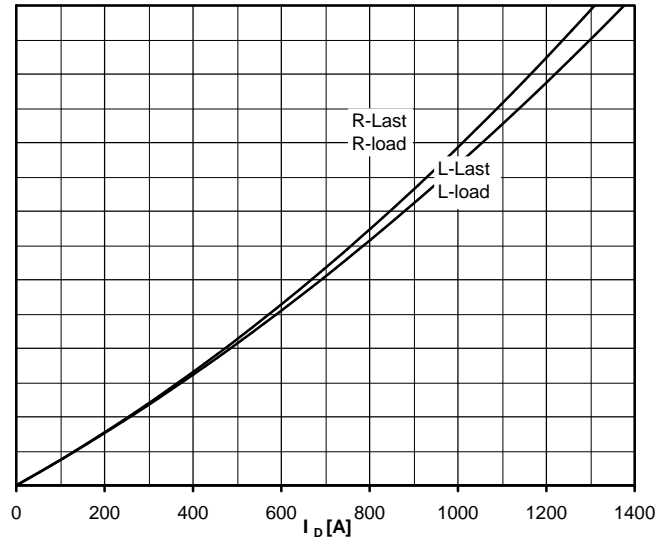
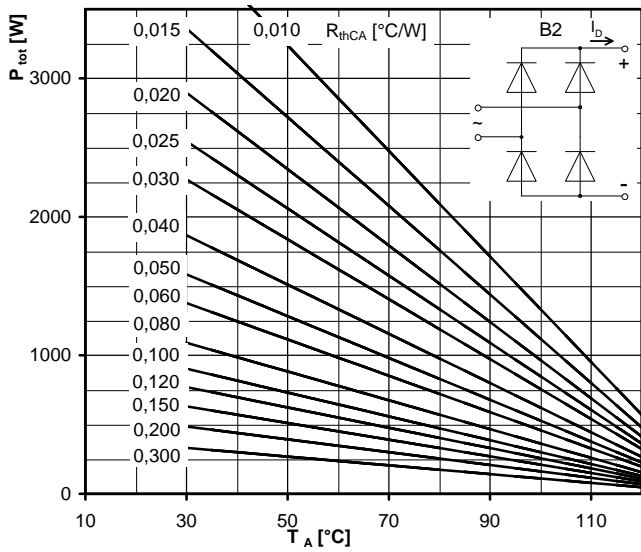

Höchstzulässiger Ausgangsstrom / Maximum rated output current I_D

B2- Zweipuls-Brückenschaltung / Two-pulse bridge circuit

Gesamtverlustleistung der Schaltung / Total power dissipation at circuit P_{tot}

Parameter:

Wärmewiderstand zwischen den Gehäusen und Umgebung / Thermal resistance cases to ambient R_{thCA}

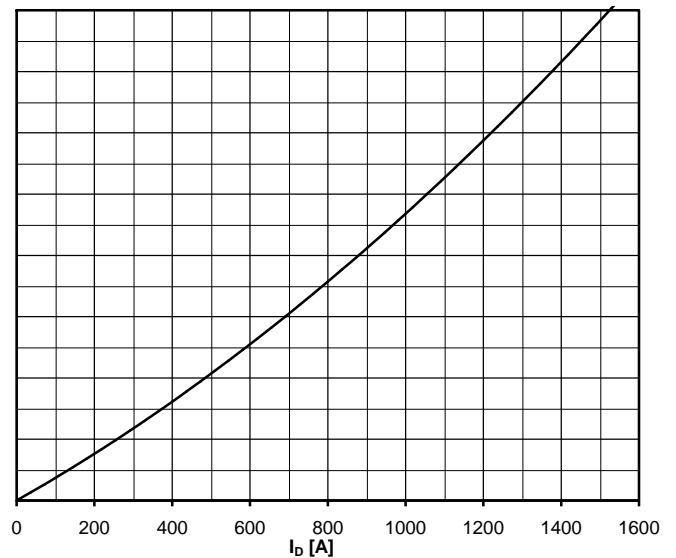
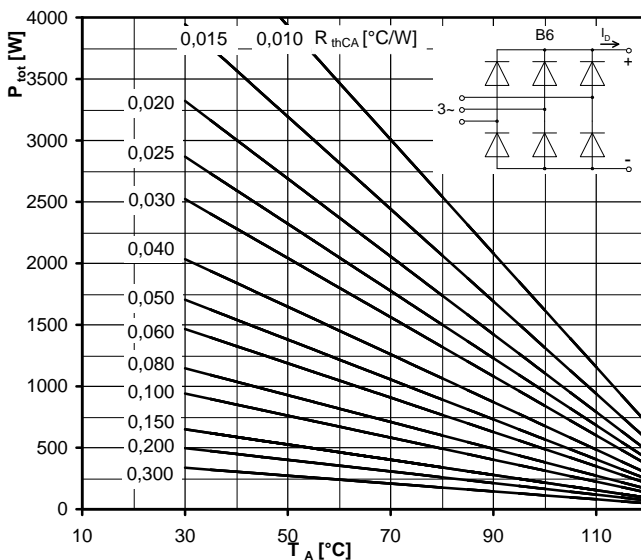

Höchstzulässiger Ausgangsstrom / Maximum rated output current I_D

B6- Sechspuls-Brückenschaltung / Six-pulse bridge circuit

Gesamtverlustleistung der Schaltung / Total power dissipation at circuit P_{tot}

Parameter:

Wärmewiderstand zwischen den Gehäusen und Umgebung / Thermal resistance cases to ambient R_{thCA}



Netz-Thyristor-Modul
Phase Control Thyristor Module

TZ600N

Infineon Technologies Bipolar
GmbH & Co. KG

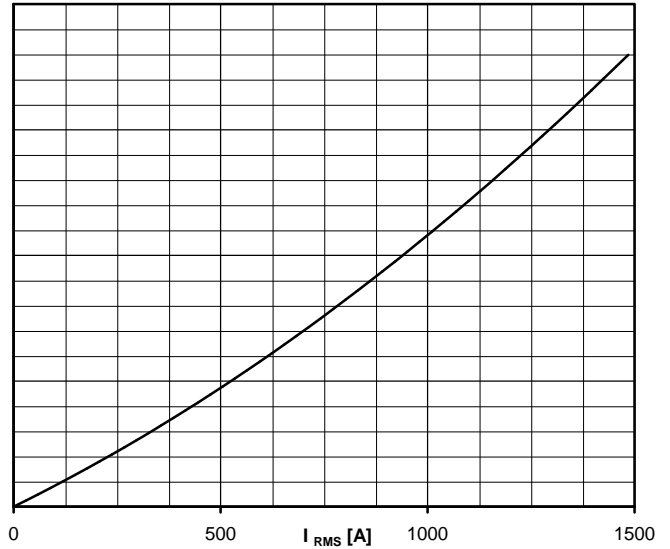
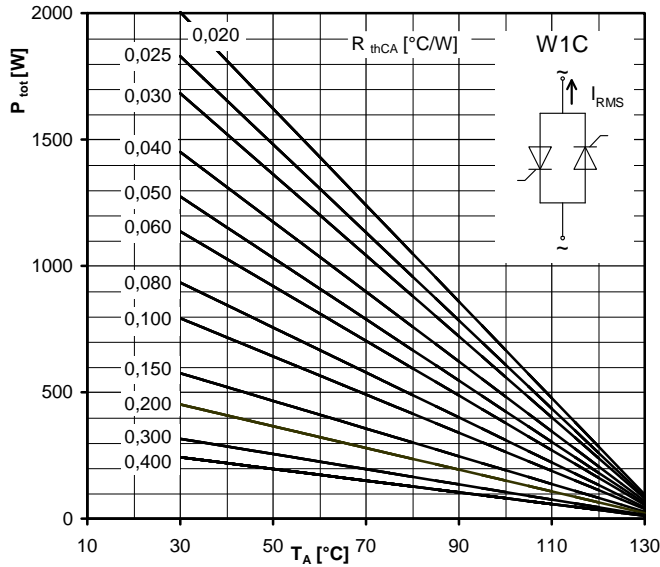

Höchstzulässiger Effektivstrom / Maximum rated RMS current I_{RMS}

W1C - Einphasen-Wechselwegschaltung / Single-phase inverse parallel circuit

Gesamtverlustleistung der Schaltung / Total power dissipation at circuit P_{tot}

Parameter:

Wärmewiderstand zwischen den Gehäusen und Umgebung / Thermal resistance case to ambient R_{thCA}

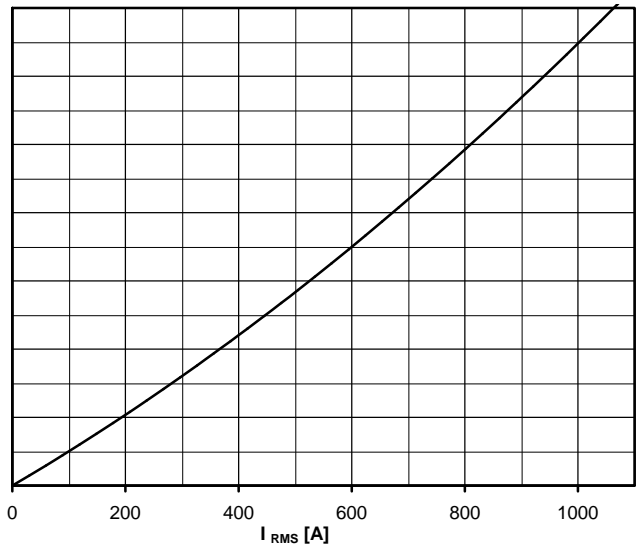
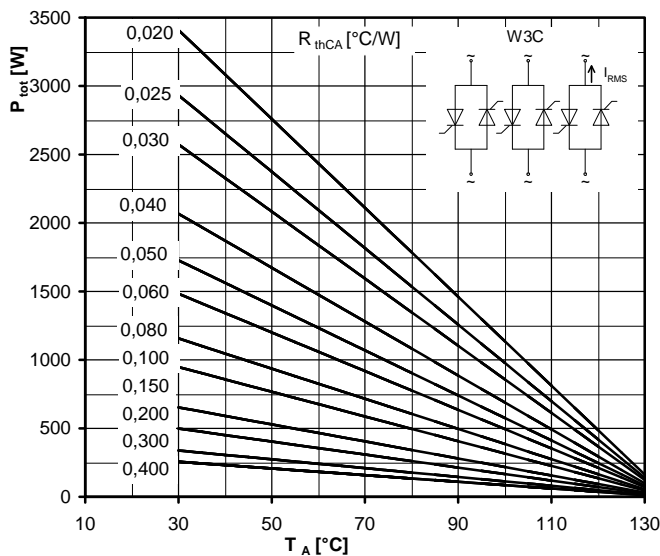

Höchstzulässiger Effektivstrom / Maximum rated RMS current I_{RMS}

W3C - Dreiphasen-Wechselwegschaltung / Three-phase inverse parallel circuit

Gesamtverlustleistung der Schaltung / Total power dissipation at circuit P_{tot}

Parameter:

Wärmewiderstand zwischen den Gehäusen und Umgebung / Thermal resistance cases to ambient R_{thCA}

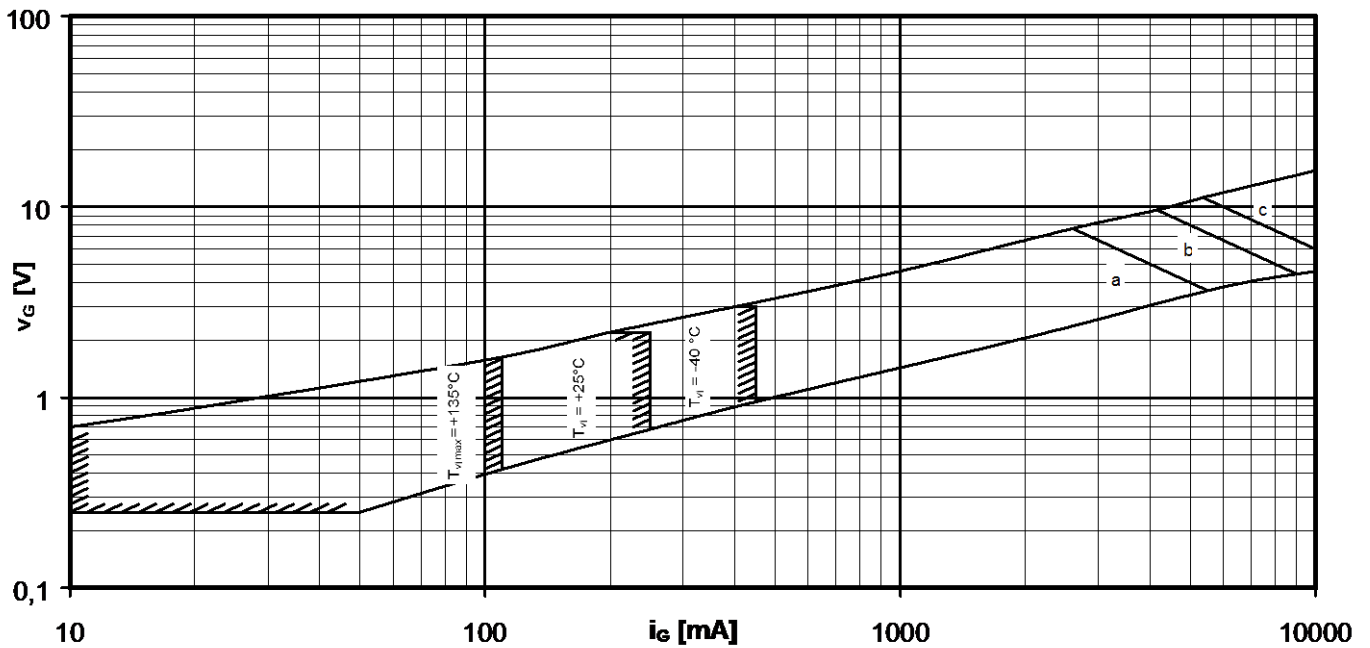

Steuercharakteristik $v_G = f(i_G)$ mit Zündbereichen für $V_D = 6\text{ V}$
Gate characteristic $v_G = f(i_G)$ with triggering area for $V_D = 6\text{ V}$

Höchstzulässige Spitzensteuerverlustleistung / Maximum rated peak gate power dissipation $P_{GM} = f(t_G)$:

a - 20 W/10ms b - 40 W/1ms c - 60 W/0,5ms

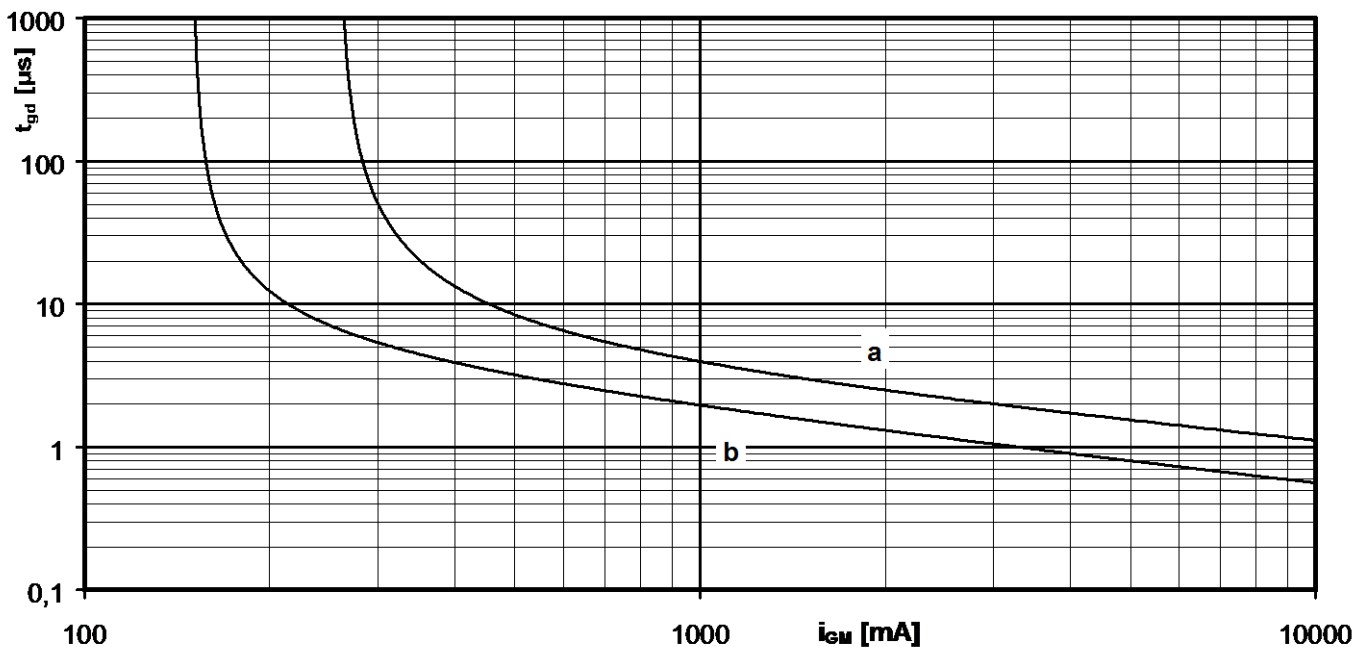

Zündverzögerung / Gate controlled delay time $t_{gd} = f(i_G)$

$T_{vj} = 25^\circ\text{C}$, $di_G/dt = i_{GM}/1\mu\text{s}$

a - maximaler Verlauf / Limiting characteristic

b - typischer Verlauf / Typical characteristic

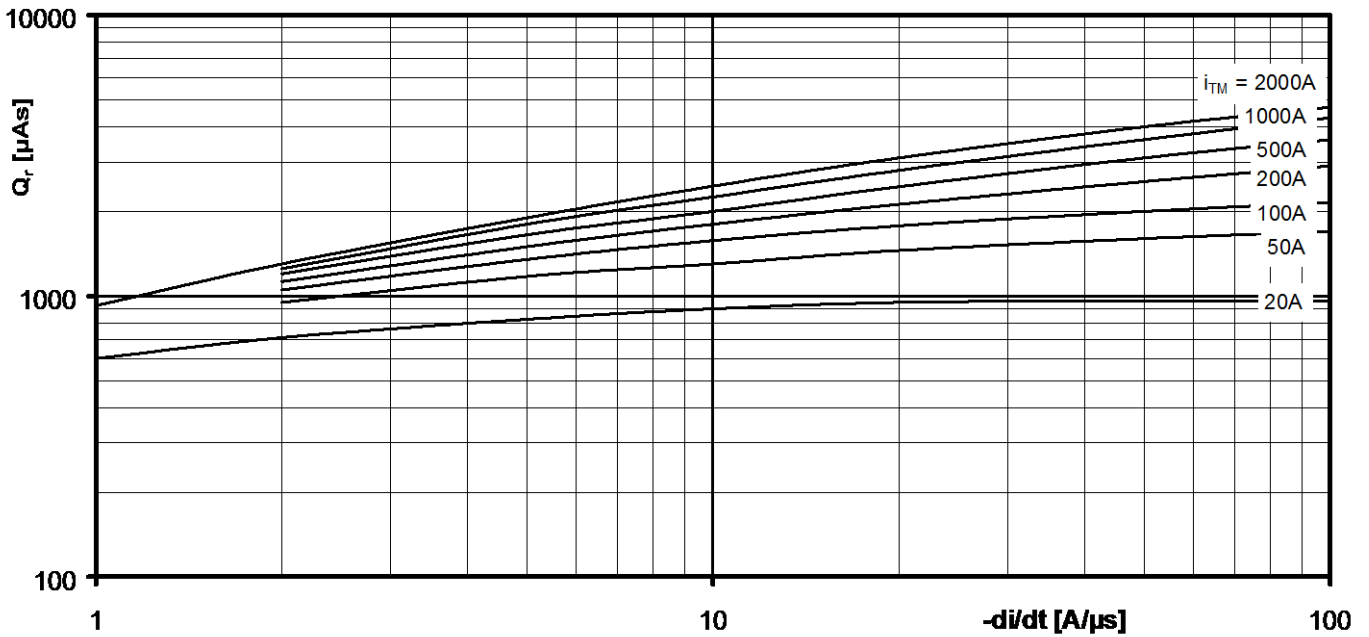

Sperrverzögerungsladung / Recovered charge $Q_r = f(-di/dt)$

$T_{vj} = T_{vjmax}, v_R \leq 0,5 V_{RRM}, v_{RM} = 0,8 V_{RRM}$

Parameter: Durchlaßstrom / On-state current i_{TM}

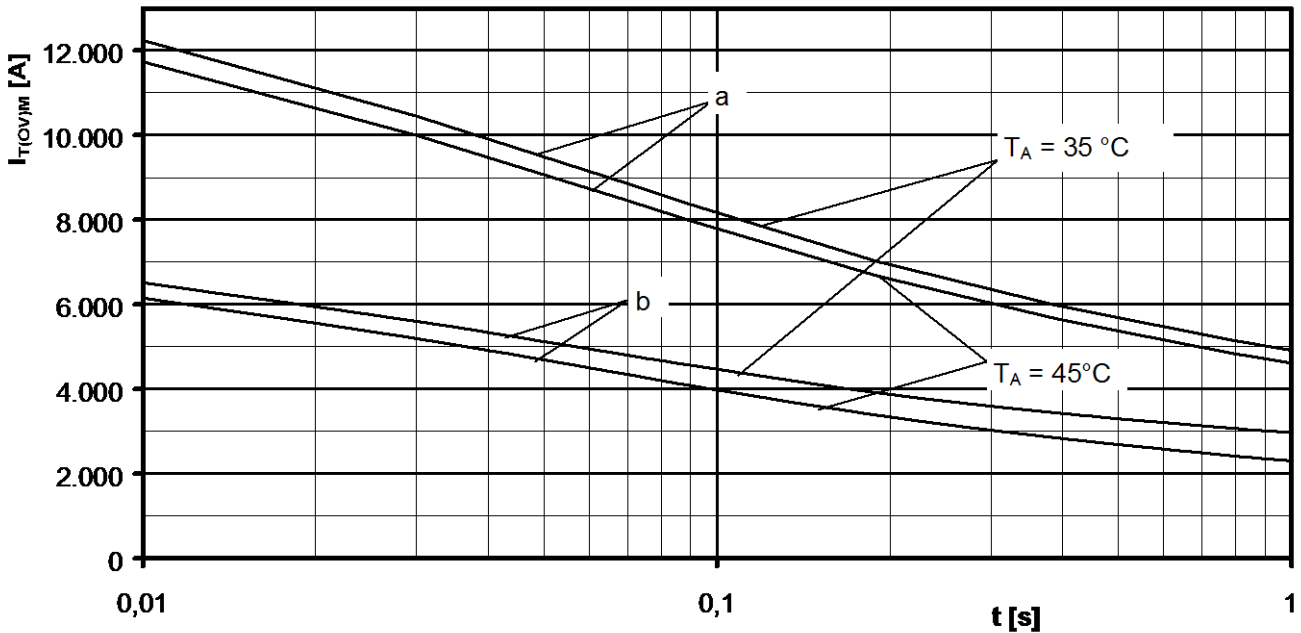

Grenzstrom / Maximum overload on-state current $I_{T(OV)M} = f(t), v_{RM} = 0,8 V_{RRM}$

a: Leerlauf / No-load conditions

b: nach Belastung mit I_{TAVM} / after load with I_{TAVM}

$T_A = 35^\circ\text{C}$, verstärkte Luftkühlung / Forced air cooling

$T_A = 45^\circ\text{C}$, Luftselbstkühlung / Natural air cooling

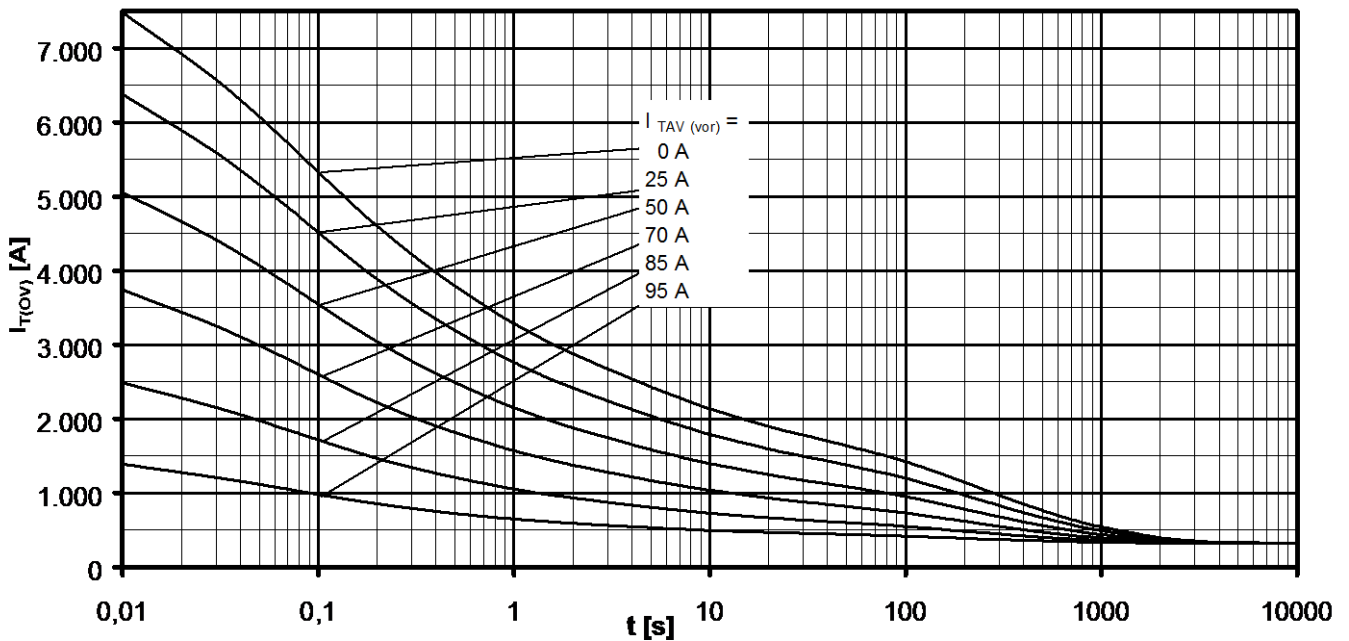

Überstrom je Zweig / Overload on-state current $I_{T(ov)}$

B6- Sechspuls-Brückenschaltung, 120° Rechteck / Six-pulse bridge circuit, 120° rectangular

Kühlkörper / Heatsink type KM17 (90W) Luftselbstkühlung bei / Natural cooling at $T_A = 45^\circ\text{C}$

Parameter: Vorlaststrom je Zweig / Pre-load current per arm $I_{TAV(vor)}$

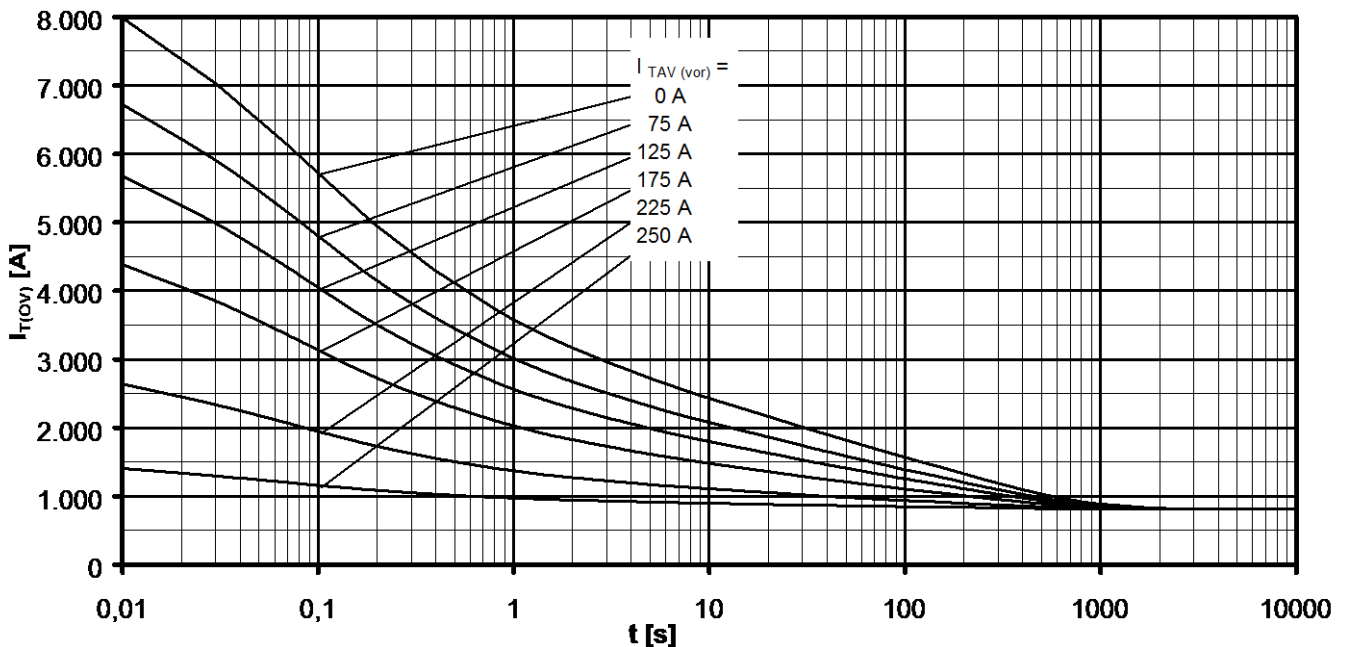

Überstrom je Zweig / Overload on-state current $I_{T(ov)}$



B6- Sechspuls-Brückenschaltung, 120° Rechteck / Six-pulse bridge circuit, 120° rectangular

Kühlkörper / Heatsink type KM17 (Papst 4650N) Verstärkte Kühlung bei / Forced cooling at $T_A = 35^\circ\text{C}$

Parameter: Vorlaststrom je Zweig / Pre-load current per arm $I_{TAV(vor)}$

Looking for pricing, stock, or lifecycle information?

Click below to explore more details on WIN SOURCE:

-  [View TZ600N16KOFHPSA1 on WIN SOURCE](#)
-  [Infineon Technologies Information](#)

Optimize Your Supply Chain with WIN SOURCE Solutions

-  Global Sourcing Solution
-  Obsolete Management
-  Cost Control Management
-  Shortage Management
-  Alternative Solution
-  Excess Inventory Management