



**THE DATASHEET OF  
CD31.1501.151**



IEC Appliance Inlet C14 with Filter, Fuseholder 1- or 2-pole (5x20 mm or 6.3x32 mm), Line Switch 1- or 2-pole, Voltage Selector (Step)



See below:  
[Approvals and Compliances](#)

**Description**

- Panel mount :  
Screw-on mounting front side
- 5 Functions :  
Appliance Inlet , Line Switch , Fuseholder with interchangeable fuse drawer for Fuse-links 5x20 mm or 6.3x32 mm , with or without voltage selector (step switch) , Line filter in standard and medical version
- V-Lock notch standard
- Quick connect terminals 4.8 x 0.8 mm

**Unique Selling Proposition**

- Multifunctional Power Entry Module
- Solid metal flange
- Various fuse drawers
- Slim design

**Characteristics**

- All single elements are already wired
- The fuse drawer "Fingerrip" can be removed by hand
- For applications according IEC/UL 62368-1 we recommend variants with bleed resistor
- Suitable for use in medical equipment according to IEC/UL 60601-1 (1 MOOP, 1 MOPP)

**References**

Alternative: version without line filter [KD](#)

**Weblinks**

[pdf data sheet](#), [html datasheet](#), [General Product Information](#), [Approvals](#), [Distributor-Stock-Check](#), [Accessories](#), [Detailed request for product](#)

**Technical Data**

Ratings IEC	1 - 10A @ Ta 40 °C / 250 VAC; 50Hz	Appliance inlet/-outlet	C14 acc. to IEC 60320-1, UL 498, CSA C22.2 no. 42 (for cold conditions) pin-temperature 70 °C, 10A, Protection Class I
Ratings UL/CSA	1 - 10A @ Ta 40 °C / 250 VAC; 60Hz	Fuseholder	1-/2-pole, Shocksafe category PC2 acc. to IEC 60127-6, for fuse-links 5 x 20 / 6.3 x 32mm
Leakage Current	standard < 0.5 mA (250 V / 60 Hz) medical < 5 µA (250 V / 60 Hz)	Rated Power Acceptance @ Ta 23 °C	5 x 20: 2.5W (1 pole)/ 2W (2-pole) per pole 6.3 x 32: 3.15W (1 pole)/ 2.5W (2-pole) per pole
Dielectric Strength	> 1.7 kVDC between L-N > 2.7 kVDC between L/N-PE Test voltage (2 sec)	Power Acceptance @ Ta > 23°C	Admissible power acceptance at higher ambient temperature see derating curves
Allowable Operation Temperature	-25 °C to 85 °C	Line Switch	2-pole, non-illuminated, acc. to IEC 61058-1 <a href="#">Technical Details</a>
Climatic Category	25/085/21 acc. to IEC 60068-1	Voltage Selector	optional, step, 2-4 digits
IP-Protection	front side IP40 acc. to IEC 60529	Line Filter	Standard and Medical Version, IEC 60939, UL 1283, CSA C22.2 no. 8 <a href="#">Technical Details</a>
Protection Class	Suitable for appliances with protection class I acc. to IEC 61140	MTBF	> 1'200'000h acc. to MIL-HB-217 F
Terminal	Quick connect terminals 4.8 x 0.8 mm		
Panel Thickness S	Screw: max 8 mm Mounting screw torque max 0.5 Nm		
Material	Thermoplastic, black, UL 94V-0		

**Approvals and Compliances**



Detailed information on product approvals, code requirements, usage instructions and detailed test conditions can be looked up in [Details about Approvals](#)

SCHURTER products are designed for use in industrial environments. They have approvals from independent testing bodies according to national and international standards. Products with specific characteristics and requirements such as required in the automotive sector according to IATF 16949, medical technology according to ISO 13485 or in the aerospace industry can be offered exclusively with customer-specific, individual agreements by SCHURTER.

## Approvals







The approval mark is used by the testing authorities to certify compliance with the safety requirements placed on electronic products.

Approval Reference Type: CD

Approval Logo	Certificates	Certification Body	Description
	<a href="#">VDE Approvals</a>	VDE	Certificate Number: 40004665 (FKSO, FKSP, FKSU, FKSV)
	<a href="#">UL Approvals</a>	UL	UR File Number: E72928 (FKSO, FKSP, FKSU, FKSV)

## Product standards

Product standards that are referenced

Organization	Design	Standard	Description
	Designed according to	IEC 60320-1	Appliance couplers for household and similar general purposes
	Designed according to	IEC 60939	Passive filters for suppressing electromagnetic interference
	Designed according to	IEC 60127-6	Miniature fuses. Part 6. Fuse-holders for miniature fuse-links
	Designed according to	IEC 61058-1	Switches for appliances. Part 1. General requirements
	Designed according to	UL 498	Standard for Attachment Plugs and Receptacles
	Designed according to	UL 1283	Passive filters for suppressing electromagnetic interference
	Designed according to	CSA C22.2 no. 42	General Use Receptacles, Attachment Plugs, and Similar Wiring Devices
	Designed according to	CSA C22.2 no. 8	Electromagnetic interference (EMI) filters









## Application standards

Application standards where the product can be used

Organization	Design	Standard	Description
	Suitable for applications acc.	IEC/UL 62368-1	Audio/video, information and communication technology equipment - Part 1: Safety requirements
	Suitable for applications acc.	IEC 60601-1	Medical electrical equipment - Part 1: General requirements for basic safety and essential performance
	Suitable for applications acc.	IEC 60335-1	Safety of electrical appliances for household and similar purposes. Meets the requirements for appliances in unattended use. This includes the enhanced requirements of glow wire tests acc. to IEC 60695-2-11 or -12 & -13.

## Compliances

The product complies with following Guide Lines

Identification	Details	Initiator	Description
	<a href="#">CE declaration of conformity</a>	SCHURTER AG	The CE marking declares that the product complies with the applicable requirements laid down in the harmonisation of Community legislation on its affixing in accordance with EU Regulation 765/2008.
	<a href="#">UKCA declaration of conformity</a>	SCHURTER AG	The UKCA marking declares that the product complies with the applicable requirements laid down in the British Amendment of Regulation (EC) 765/2008.
	RoHS	SCHURTER AG	Directive RoHS 2011/65/EU, Amendment (EU) 2015/863
	China RoHS	SCHURTER AG	The law SJ / T 11363-2006 (China RoHS) has been in force since 1 March 2007. It is similar to the EU directive RoHS.
	REACH	SCHURTER AG	On 1 June 2007, Regulation (EC) No 1907/2006 on the Registration, Evaluation, Authorization and Restriction of Chemicals 1 (abbreviated as "REACH") entered into force.
		SCHURTER AG	V-Lock system are based on a matching plug-dose combination. The connector is equipped with a notch intended for use with the latching cordset. The cord latching system prevents against accidental removal of the cordset.
	White Paper Glow wire test	SCHURTER AG	Meets the requirements of IEC 60335-1 for appliances in unattended use. This includes the enhanced requirements of glow wire tests acc. to IEC 60695-2-11 or -12 & -13.
	Medical Equipment	SCHURTER AG	Suitable for use in medical equipment according to IEC/UL 60601-1 (1 MOOP, 1 MOPP)

Dimension [mm]  
 CD

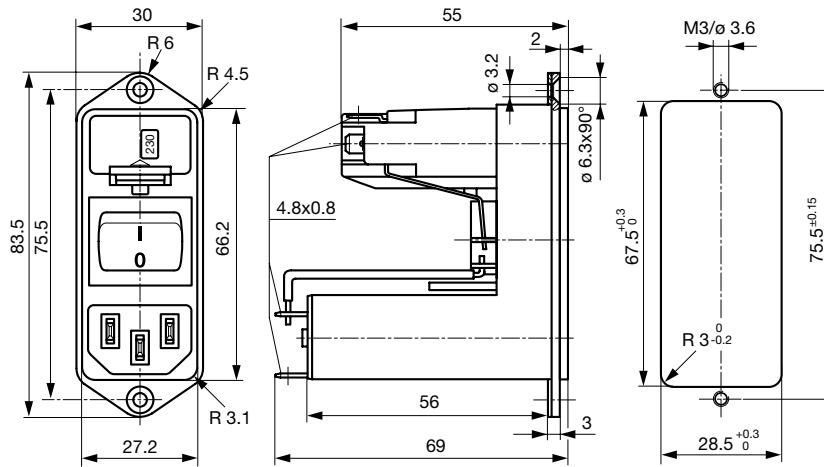

Technical Data of Filter-Components

Rated Current [A]	Filter-Type	Inductances L [mH]	Capacitance CX [nF]	Capacitance CY [nF]	R [MΩ]
1	Standard version	2 x 10	68	2.2	-
2	Standard version	2 x 4	68	2.2	-
4	Standard version	2 x 1.5	68	2.2	-
6	Standard version	2 x 0.8	68	2.2	-
10	Standard version	2 x 0.3	68	2.2	-
1	Medical Version (M5)	2 x 10	68	-	1
2	Medical Version (M5)	2 x 4	68	-	1
4	Medical Version (M5)	2 x 1.5	68	-	1
6	Medical Version (M5)	2 x 0.8	68	-	1
10	Medical Version (M5)	2 x 0.3	68	-	1
2	Medical Version (M80)	2 x 4	68	0.47	1
4	Medical Version (M80)	2 x 1.5	68	0.47	1
10	Medical Version (M80)	2 x 0.3	68	0.47	1

Diagrams

Standard version

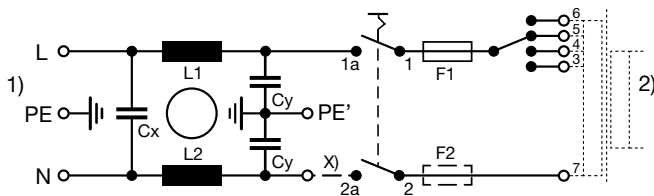

- 1) Line
- 2) Load
- x) External connection to be made by the customer

Medical Version (M5)

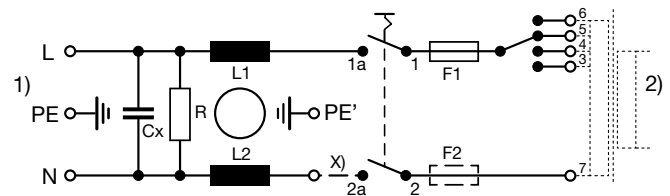

- 1) Line
- 2) Load
- x) External connection to be made by the customer

**Derating Curves**

**Fuses**

5 x 20 mm (1-pole)

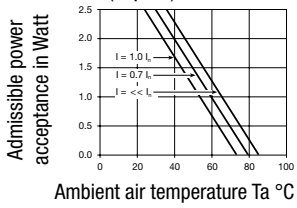

**Fuses**

5 x 20 mm (2-pole, per pole)

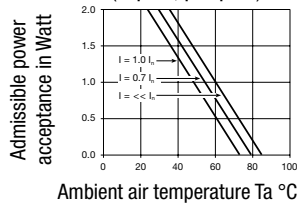

**Fuses**

6.3 x 32 mm (1-pole)

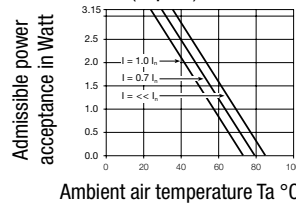

**Fuses**

6.3 x 32 mm (2-pole, per pole)

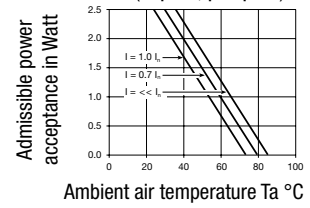

**Attenuation Loss**

--- 50Ω differential mode    \_\_\_ 50Ω common mode

Standard version

1 A

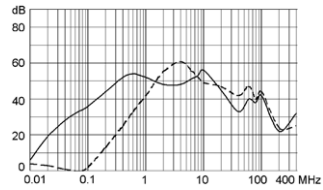

2 A

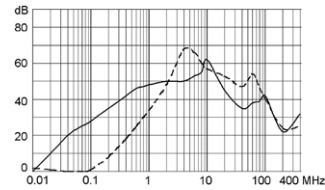

4 A

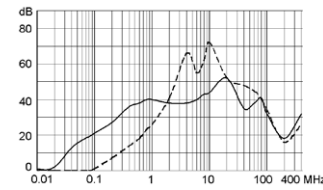

6 A

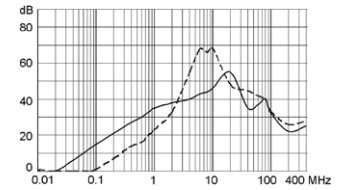

10 A

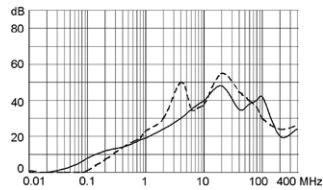

Medical version (M5)

1 A

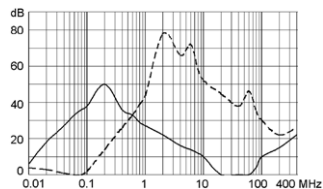

2 A

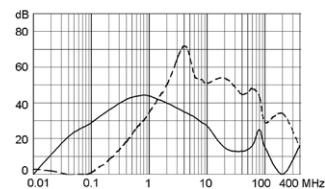

4 A

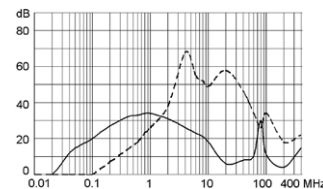

6 A

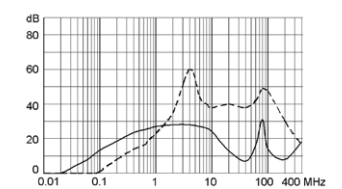

10 A

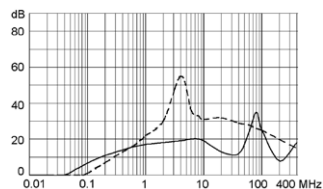

**All Variants**

Type	Rated Current [A]	Filter-Type	Fuseholder	Line Switch	Voltage Selector	V-Lock	Order Number
CD	1	Standard version	1-pole	2-pole	-	●	CD11.1501.151
CD	2	Standard version	1-pole	2-pole	-	●	CD21.1501.151
CD	4	Standard version	1-pole	2-pole	-	●	CD31.1501.151
CD	6	Standard version	1-pole	2-pole	-	●	CD41.1501.151

Type	Rated Current [A]	Filter-Type	Fuseholder	Line Switch	Voltage Selector	V-Lock	Order Number
CD	10	Standard version	1-pole	2-pole	-	●	CD61.1501.151
CD	1	Standard version	1-pole	2-pole	2-4 digits	●	CD11.4501.151
CD	2	Standard version	1-pole	2-pole	2-4 digits	●	CD21.4501.151
CD	4	Standard version	1-pole	2-pole	2-4 digits	●	CD31.4501.151
CD	6	Standard version	1-pole	2-pole	2-4 digits	●	CD41.4501.151
CD	10	Standard version	1-pole	2-pole	2-4 digits	●	CD61.4501.151
CD	1	Standard version	2-pole	2-pole	-	●	CD14.1101.151
CD	2	Standard version	2-pole	2-pole	-	●	CD24.1101.151
CD	4	Standard version	2-pole	2-pole	-	●	CD34.1101.151
CD	6	Standard version	2-pole	2-pole	-	●	CD44.1101.151
CD	10	Standard version	2-pole	2-pole	-	●	CD64.1101.151
CD	1	Standard version	2-pole	2-pole	2-4 digits	●	CD14.4101.151
CD	2	Standard version	2-pole	2-pole	2-4 digits	●	CD24.4101.151
CD	4	Standard version	2-pole	2-pole	2-4 digits	●	CD34.4101.151
CD	6	Standard version	2-pole	2-pole	2-4 digits	●	CD44.4101.151
CD	10	Standard version	2-pole	2-pole	2-4 digits	●	CD64.4101.151
CD	6	Medical Version (M5)	2-pole	2-pole	-	●	CDE4.1101.151
CD	1	Medical Version (M5)	2-pole	2-pole	2-4 digits	●	CDG4.4101.151
CD	2	Medical Version (M5)	2-pole	2-pole	2-4 digits	●	CDA4.4101.151
CD	4	Medical Version (M5)	2-pole	2-pole	2-4 digits	●	CDC4.4101.151
CD	6	Medical Version (M5)	2-pole	2-pole	2-4 digits	●	CDE4.4101.151
CD	10	Medical Version (M5)	2-pole	2-pole	2-4 digits	●	CDL4.4101.151
CD	2	Medical Version (M80)	2-pole	2-pole	2-4 digits	●	CDB4.4101.151
CD	4	Medical Version (M80)	2-pole	2-pole	2-4 digits	●	CDD4.4101.151
CD	10	Medical Version (M80)	2-pole	2-pole	2-4 digits	●	CDM4.4101.151

Most Popular.

Availability for all products can be searched real-time: <https://www.schurter.com/en/info-center/support-tools/stock-check-distributors>

The fuse drawer is not included and must be ordered separately (see required accessory).

**Packaging unit** 10 Pcs

**Required Accessory**

**Description**

[Fusedrawer\\_3](#)  
 Fusedrawer for Fuse Links 5x20 mm resp. 6.3x32 mm



Fingergrip, 5 x 20, 2-pole, Voltage Selector	4303.2014.00
Fingergrip, 5 x 20, 2-pole, Voltage Selector, 100, 120, 220, 240	4303.2014.01
Fingergrip, 5 x 20, 2-pole, Voltage Selector, 110, 150, 220	4303.2014.02
Fingergrip, 5 x 20, 2-pole, Voltage Selector, 110, 220	4303.2014.03
...	...

Accessories



**Wire\_Harness**  
 Wire harness for SCHURTER products



**Assorted\_Covers**  
 Rear Cover

0859.0077



**RC320**  
 Rear Cover for Power Entry Module



**Cord\_retaining\_kits**  
 Cord retaining strain relief

Flat head, A 4700.0001

Mating Outlets/Connectors

Category / Description

[Appliance Outlet Overview complete](#)



4787, Mounting: Screw-on mounting, Appliance Outlet: IEC Solder terminals, 10 A, Suitable for appliances with protection class I	4787
4788, Mounting: Snap-in version, Appliance Outlet: IEC Solder / Quick Connect, 10 A, Suitable for appliances with protection class I	4788
IEC Appliance Outlet F or H, Screw-on Mounting, Front Side, Solder, PCB or Quick-connect Terminal	5091

[Connector Overview complete](#)



4782 Mounting: Power Cord, 3 x 1 mm <sup>2</sup> / 3 x 18 AWG, Cable, Connector: IEC C13	4782
4785 Mounting: Power Cord, 3 x 1 mm <sup>2</sup> / 3 x 18 AWG, Cable, Connector: IEC C13	4785
4300-06 Mounting: Power Cord, 3 x 1 mm <sup>2</sup> / 3 x 18 AWG, Cable, Connector: IEC C13	4300-06
4781 Mounting: Power Cord, Cable, Connector: IEC C15	4781
4784 Mounting: Power Cord, 3 x 1 mm <sup>2</sup> / 3 x 18 AWG, Cable, Connector: IEC C15	4784

### Mating Outlets/Connectors shuttered



[Connector Overview complete](#)

4783 Mounting: Power Cord, 3 x 1 mm<sup>2</sup> / 3 x 18 AWG, Cable, Connector: IEC C13

4783





[Power Cord Overview complete](#)

VAC13KS, Overview, V-Lock cord retaining, diverse Connector IEC C13, diverse, black

VAC13KS

## Looking for pricing, stock, or lifecycle information?

Click below to explore more details on WIN SOURCE:

-  [View CD31.1501.151 on WIN SOURCE](#)
-  [Schurter Inc. Information](#)

## Optimize Your Supply Chain with WIN SOURCE Solutions

-  Global Sourcing Solution
-  Obsolete Management
-  Cost Control Management
-  Shortage Management
-  Alternative Solution
-  Excess Inventory Management