



**THE DATASHEET OF  
NFMECS640A0**



# Sensorless BLDC ecoSpin Motor Controller, with Gate Drivers

Arm® Cortex®-M0+, 600 V, FAN73896

## ECS640A

### Overview

EcoSpin Motor Controller ECS640A is a 3-phase BLDC configurable motor control system in package that integrates an ultra-low-power optimized Arm Cortex-M0+ microcontroller (Nebo-40-64), three sense amplifiers and a reference amplifier (NCS20034), three bootstrap diodes, and a high-voltage gate-driver designed for high-voltage, high-speed operation, with the ability to drive MOSFETs and IGBTs operating up to 600 V (FAN73896). Six gate driver outputs provide sink/source of 350 mA/650 mA (typ) gate current to external power devices. The device includes Hall Sensor inputs to support either sensed or sensorless operation. Three independent low-side source pins allow for single or multiple shunt measurement.

Protection functions include under-voltage lockout and inverter over-current trip with an automatic fault-clear function. An open-drain fault signal is provided to indicate that a fault condition has occurred.

Direct Torque & Flux Control (DTFC) firmware is available and allows optimal motor performance on the Arm Cortex-M0+ platform.

The small footprint and integration make this device a perfect fit with discrete power devices to maximize scalability across platforms and to minimize area requirements as power levels scale.

### Features

- Arm Cortex-M0+ (Nebo-40-64)
  - ◆ 40 MHz Clock Frequency
  - ◆ 8 kB RAM Memory
  - ◆ 64 kB Flash Memory
- 600 V Gate Driver (FAN73896)
  - ◆ 350 mA/650 mA Sourcing/Sinking Current Driving Capability
- 4 Sense Amps for Current Sensing (NCS20034)
- Integrated Bootstrap Diodes
- Communication: I<sup>2</sup>C, UART and SPI
- Firmware Available, Sensorless Direct Torque and Flux Control
- Max Power Dissipation: 1.8 W
- Temperature Range: -40 to 105°C
- These are Pb-Free Devices

### Typical Applications

- Three-Phase Brushless DC (BLDC) Sensorless Motor Control
- Three-Phase Brushless DC (BLDC) Sensor Based Motor Control

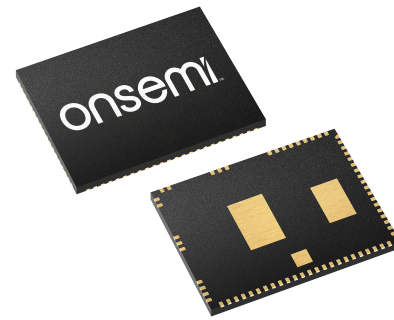

WQFN65  
CASE 510CT

### MARKING DIAGRAM

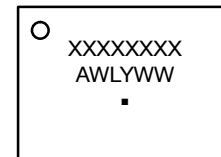

XXXXXXX	= Specific Device Code
A	= Assembly Location
WL	= Wafer Lot
Y	= Year
WW	= Work Week
▪	= Logo(s)

### ORDERING INFORMATION

See detailed ordering and shipping information on page 12 of this data sheet.

### End Products

- HVAC
- Home Appliances: Refrigerators, Fabric Care, Dishwashers
- Pumps
- General Purpose Three-Phase Motor Control

### Safety Mechanisms Highlight

- Over-Current Shutdown Turns Off All Six Channels

# ECS640A

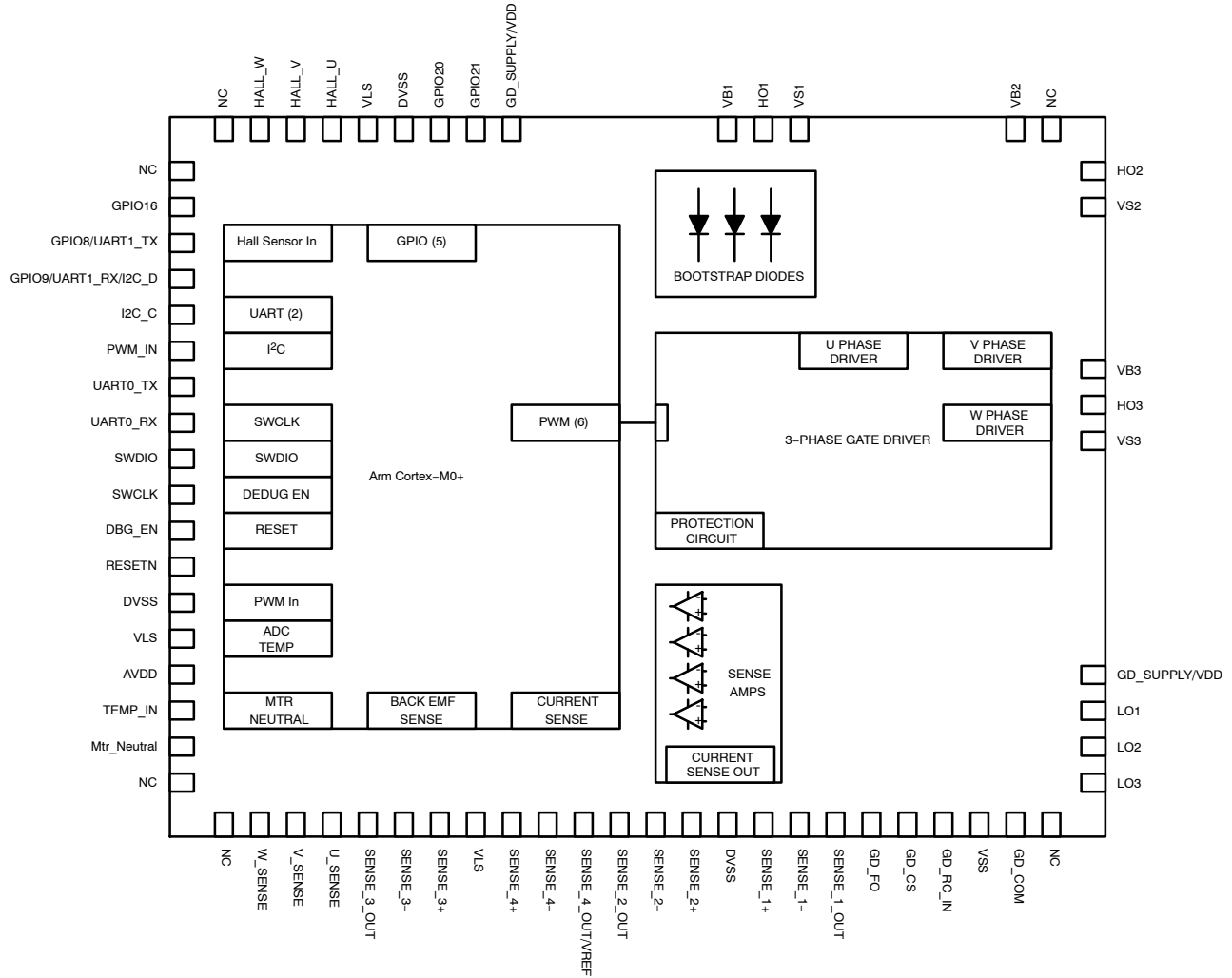

Figure 1. Block Diagram



# ECS640A

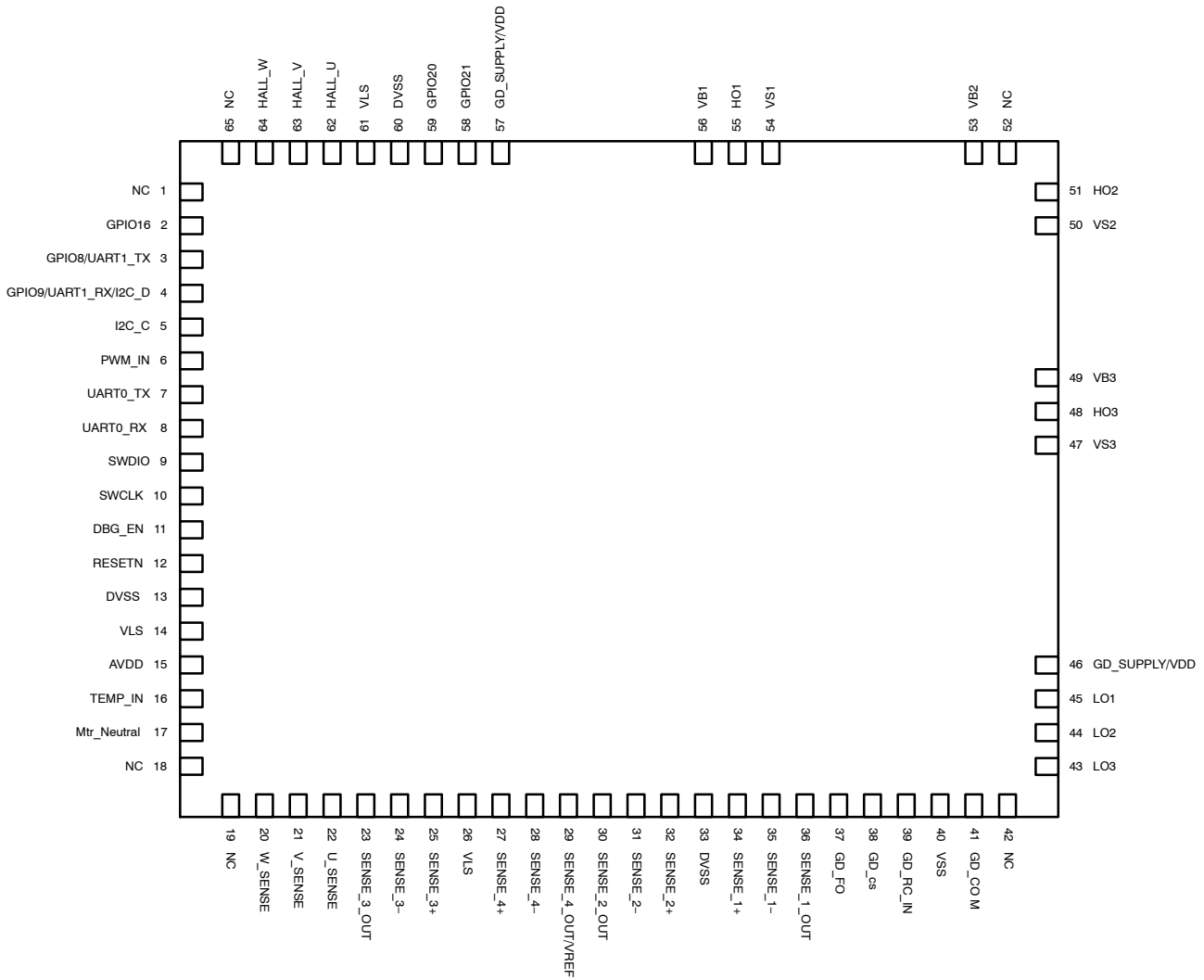

Figure 3. Pin Connections

## PIN FUNCTION DESCRIPTION

Pin #	Pin Name	Description
1	NC	-
2	GPIO16	General Purpose IO (Nebo40–64 PC0 I/O)
3	GPIO8 / UART1_TX	General Purpose IO / UART Transmit (Nebo40–64 PB0 I/O)
4	GPIO9 / UART1_RX / I2C_D	General Purpose IO / UART Receive / I <sup>2</sup> C (Nebo40–64 PB1 I/O)
5	I2C_C	I2C (Nebo40–64 PB2 I/O)
6	PWM_IN	PWM Input Signal (Nebo40–64 PB3 I/O)
7	UART0_TX	UART Transmit (Nebo40–64 PB4 I/O)
8	UART0_RX	UART Receive (Nebo40–64 PB5 I/O)
9	SWDIO	Single Wire Interface Data (Nebo40–64 PB6 I/O)
10	SWCLK	Single Wire Interface Clock (Nebo40–64 PB7 I/O)
11	DBG_EN	Debug Enable (Nebo40–64 DBG_EN)
12	RESETN	μC Reset (Nebo40–64 RESETN)
13	DVSS	Ground
14	VLS	3.3 V Supply for Micro–Controller

# ECS640A

## PIN FUNCTION DESCRIPTION (continued)

Pin #	Pin Name	Description
15	AVDD	Analog Reference Voltage Out
16	TEMP_IN / GP_A_1	General Analog Input or Temperature Sensor Input (Nebo40–64 PA0 I/O)
17	Mtr_Neutral / GP_A_0	Motor Center Tap Input or Bus Voltage Input (Nebo40–64 PA1 I/O)
18	NC	–
19	NC	–
20	W_SENSE	Back EMF Sense Pin – Phase W (requires reduction and filtering) (Nebo40–64 PA2 I/O)
21	V_SENSE	Back EMF Sense Pin – Phase V (requires reduction and filtering) (Nebo40–64 PA3 I/O)
22	U_SENSE	Back EMF Sense Pin – Phase U (requires reduction and filtering) (Nebo40–64 PA4 I/O)
23	SENSE_3_OUT	Amplifier 3 Output (Nebo40–64 PA5 I/O)
24	SENSE_3–	Amplifier 3–
25	SENSE_3+	Amplifier 3+
26	VLS	3.3 V Supply for Amplifier
27	SENSE_4+	Amplifier 4+
28	SENSE_4–	Amplifier 4–
29	SENSE_4_OUT / VREF	Sense Amplifier can be used for voltage reference
30	SENSE_2_OUT	Amplifier 2 Output (Nebo40–64 PA7 I/O)
31	SENSE_2–	Amplifier 2+
32	SENSE_2+	Amplifier 2–
33	DVSS	Amplifier V <sub>SS</sub>
34	SENSE_1+	Amplifier 1+
35	SENSE_1–	Amplifier 1–
36	SENSE_1_OUT	Amplifier 1 Output (Nebo40–64 PA6 I/O)
37	GD_FO	Fault output (Nebo40–64 PC6 I/O) (FAN73896 FO output)
38	GD_CS	Analog input for over–current shutdown (FAN73896 CS input)
39	GD_RC_IN	External RC network input used to define the fault–clear delay
40	VSS	Gate Driver V <sub>SS</sub>
41	GD_COM	Gate Driver Low Side Common
42	NC	–
43	LO3	Low–Side Gate Driver 3 Output
44	LO2	Low–Side Gate Driver 2 Output
45	LO1	Low–Side Gate Driver 1 Output
46	GD_Supply / VDD	15 V supply for Gate Driver
47	VS3	High–Side Driver 3 Floating Supply Offset Voltage
48	HO3	High–Side Driver 3 Gate Driver Output
49	VB3	High–Side Supply 3 Floating Supply
50	VS2	High–Side Driver 2 Floating Supply Offset Voltage
51	HO2	High–Side Driver 2 Gate Driver Output
52	NC	–
53	VB2	High–Side Driver 2 Floating Supply
54	VS1	High–Side Driver 1 Floating Supply Offset Voltage
55	HO1	High–Side Driver 1 Gate Driver Output
56	VB1	High–Side Driver 1 Floating Supply
57	GD_Supply / VDD	15 V Supply for Gate Driver

# ECS640A

## PIN FUNCTION DESCRIPTION (continued)

Pin #	Pin Name	Description
58	GPIO21	General Purpose IO (Nebo40–64 PC5 I/O)
59	GPIO20	General Purpose IO (Nebo40–64 PC4 I/O)
60	DVSS	Ground
61	VLS	3.3 V Supply for Micro–Controller
62	HALL_U	Hall Sensor Input U (Nebo40–64 PC3 I/O)
63	HALL_V	Hall Sensor Input V (Nebo40–64 PC2 I/O)
64	HALL_W	Hall Sensor Input W (Nebo40–64 PC1 I/O)
65	NC	–
Exposed Thermal Pads		See recommended mounting footprint.

## MAXIMUM RATINGS

Rating	Symbol	Minimum	Maximum	Unit
Primary Supply Voltage – MCU	$V_{LS}$	–0.3	3.6	V
Ground Voltage	$DV_{SS}$	–0.3	–	V
Input Voltage Range (Note 1)	$V_{IN}$	$DV_{SS} - 0.3$	$V_{DD} + 0.3$	V
Input Pin Current – MCU	$I_{IN}$	–10	10	mA
Power Dissipation	$P_D$	–	1.8	W
Ambient Temperature	$T_A$	–40	105	°C
Storage Temperature Range	$T_{STG}$	–55	150	°C

## GATE DRIVER

High–Side Floating Offset Voltage	$V_S$	$V_{B1,2,3} - 25$	$V_{B1,2,3} + 0.3$	V
High–Side Floating Supply Voltage	$V_B$	–0.3	625.0	V
Low–Side and Logic–Fixed Supply Voltage	$V_{DD}$	–0.3	25.0	V
High–Side Floating Output Voltage $V_{HO1,2,3}$	$V_{HO}$	$V_{S1,2,3} - 25$	$V_{S1,2,3} + 0.3$	V
Low–Side Floating Output Voltage $V_{LO1,2,3}$	$V_{LO}$	–0.3	$V_{DD} + 0.3$	V
Input Voltage	$V_{IN}$	–0.3	5.5	V
Fault Output Voltage (FO)	$V_{FO}$	–0.3	$V_{DD} + 0.3$	V
High–Side Input Pulse Width	$PW_{HIN}$	500	–	Ns
Allowable Offset Voltage Slew Rate	$dV_g/dt$	–	±50	V/ns

## BOOTSTRAP DIODE

Maximum Repetitive Reverse Voltage	$V_{RRM}$	–	600	V
Forward Current	$I_F$	–	0.50	A
Forward Current (Peak)	$I_{FP}$	–	1.50	A

## CURRENT SENSOR AMPLIFIER

Supply Voltage ( $V_{DD} - V_{SS}$ )	$V_{DD}$ (Pin33)	–0.3	3.6	V
--------------------------------------	------------------	------	-----	---

ESD Capability, Human Body Model (Note 2)	$V_{HBM}$	–	≥2000	V
ESD Capability, Charged Device Model (Note 2)	$V_{CDM}$	–	≥1000	V

Stresses exceeding those listed in the Maximum Ratings table may damage the device. If any of these limits are exceeded, device functionality should not be assumed, damage may occur and reliability may be affected.

- Refer to ELECTRICAL CHARACTERISTICS, RECOMMENDED OPERATING RANGES and/or APPLICATION INFORMATION for Safe Operating parameters.
- This device series incorporates ESD protection and is tested by the following methods:  
 ESD Human Body Model tested per AEC–Q100–002 (EIA/JESD22–A114)  
 ESD Machine Model tested per AEC–Q100–003 (EIA/JESD22–A115)  
 Latchup Current Maximum Rating: ≤150 mA per JEDEC standard: JESD78

# ECS640A

## THERMAL CHARACTERISTICS (Note 3)

Rating	Symbol	Value	Unit
Thermal Resistance – Junction to Ambient (Note 4)	$\Theta_{JA}$	24.6	°C/W
Thermal Resistance – Junction to Case	$\Theta_{JC}$	4.9	°C/W

3. Refer to ELECTRICAL CHARACTERISTICS, RECOMMENDED OPERATING RANGES and/or APPLICATION INFORMATION for Safe Operating parameters.  
 4. Values based on copper area of 645 mm<sup>2</sup> (or 1 in<sup>2</sup>) of 1 oz copper thickness and FR4 PCB substrate.

## RECOMMENDED OPERATING RANGES

Rating	Symbol	Min	Max	Unit
Input Supply Voltage	$V_{LS}$	3.0	3.6	V
Ambient Temperature	$T_A$	-40	85	°C

### GATE DRIVER

High-Side Floating Supply Voltage	$V_{B1,2,3}$	$V_{s1,2,3} + 10$	$V_{s1,2,3} + 20$	V
High-Side Floating Supply Offset Voltage	$V_{s1,2,3}$	$6 - V_{DD}$	600	V
Low-Side and Logic Fixed Supply Voltage	$V_{DD}$	12	20	V
High-Side Output Voltage	$V_{HO1,2,3}$	$V_{s1,2,3}$	$V_{B1,2,3}$	V
Low-Side Output Voltage	$V_{LO1,2,3}$	COM	$V_{DD}$	V
Fault Output Voltage (FO)	$V_{FO}$	$V_{SS}$	$V_{DD}$	V
Current-Sense Pin Input Voltage	$V_{CS}$	$V_{SS}$	5	V
Logic Input Voltage (HIN1,2,3 and LIN1,2,3)	$V_{IN}$	$V_{SS}$	5	V
Low-Side Driver Return	COM	-5	5	V

### BOOTSTRAP DIODE

Forward Voltage	$V_F$	-	-	V
Reverse-Recovery Time	$t_{rr}$	-	-	ns

### CURRENT SENSOR AMPLIFIER

Operating Supply Voltage ( $V_{DD} - V_{SS}$ )	$V_s$	1.8	3.6	V
--	-------	-----	-----	---

Functional operation above the stresses listed in the Recommended Operating Ranges is not implied. Extended exposure to stresses beyond the Recommended Operating Ranges limits may affect device reliability.

## ELECTRICAL CHARACTERISTICS

Parameter	Test Conditions	Symbol	Min	Typ	Max	Unit
-----------	-----------------	--------	-----	-----	-----	------

$MCUV_{DDIO} = 3.3\text{ V}$ ,  $T_A = 30^\circ\text{C}$

### Digital I/O

Logic Input Low Threshold		$V_{IL}$	0.3	-	-	$V_{DD}$
Logic Input High Threshold		$V_{IH}$	-	-	0.7	$V_{DD}$
Internal Pull-up Resistor		$R_{PU}$	35	-	-	k $\Omega$
Internal Pull-down Resistor		$R_{PD}$	35	-	-	k $\Omega$
Logic Output Low Level	$I_{LOAD} = 4\text{ mA}$ at $V_{DDIO} = 1.8\text{ V}$	$V_{OL}$	-	-	0.5	V
Logic Output High Level	$I_{LOAD} = 4\text{ mA}$ at $V_{DDIO} = 1.8\text{ V}$	$V_{OH}$	$V_{DD} - 0.5$	-	-	V
Pin Leakage		$I_{LEAK}$	-1	-	1	$\mu\text{A}$

### Flash Memory

Read Access Time		$T_{ACC}$	-	-	40	ns
Program Time		$T_{PROG}$	-	-	20	$\mu\text{s}$
Page/Mass Erase Time		$T_{ERASE}$	-	-	10	ms
Data Retention		$T_{RET}$	10	-	-	Years

# ECS640A

## ELECTRICAL CHARACTERISTICS (continued)

Parameter	Test Conditions	Symbol	Min	Typ	Max	Unit
-----------	-----------------	--------	-----	-----	-----	------

### Flash Memory

Flash Endurance Erase Cycles	at 25°C		100k	-	-	Cycles
	at 85°C		10k	-	-	

### Power-On RESET and BROWN-OUT

Power-on Voltage Trip Point	Rising	V <sub>POR_R</sub>	1.540	-	1.635	V
	Falling	V <sub>POR_F</sub>	1.455	-	1.635	
Brownout Trip Point	Rising	V <sub>BO_R</sub>	1.525	-	1.71	V
	Falling	V <sub>BO_F</sub>	1.5	-	1.685	

### High Speed RC Oscillator (HSOSC)

Oscillator Frequency	40 MHz	F <sub>HSOSC</sub>	38.80	40.00	41.20	MHz
Temperature Drift	Temp Co = +3% Cold and -3% Hot	ΔF <sub>HSOSC</sub>	-	±3%	-	
Oscillator Start-up Time		T <sub>HSOSC_SU</sub>	-	2	-	μs
Current Consumption		I <sub>HSOSC</sub>	-	350	-	μA

### Low Power RC Oscillator (LPOSC)

Oscillator Frequency (Fast Mode)	Trimmed	F <sub>LPOSC</sub>	-	10.24	-	kHz
Oscillator Frequency (Slow Mode)	Trimmed	F <sub>LPOSC</sub>	-	640	-	Hz
Temperature Drift		ΔF <sub>LPOSC</sub>	-	±6%	-	
Oscillator Start-up Time (Fast Mode)		T <sub>LPOSC_SU</sub>	-	0.41	-	ms
Oscillator Start-up Time (Slow Mode)		T <sub>LPOSC_SU</sub>	-	1.4	-	ms
Current Consumption (Fast Mode)		I <sub>LPOSC</sub>	-	420	-	nA
Current Consumption (Slow Mode)		I <sub>LPOSC</sub>	-	95	-	nA

### High Speed Crystal Oscillator

Crystal Frequency		F <sub>HSXTAL</sub>	8	32	40	MHz
-------------------	--	---------------------	---	----	----	-----

### Low Power Crystal Oscillator

Crystal Frequency		F <sub>LPXTAL</sub>	-	32.768	-	kHz
Current Consumption		I <sub>LPXTAL</sub>	-	285	-	nA

### Analog Comparators

Common Mode Input Range		V <sub>CMIR</sub>	0.2	-	V <sub>DDIO</sub> - 0.5	V
Response Time		T <sub>COMP</sub>	-	200	-	ns

### Analog to Digital Converter (ADC)

Sample Clock Frequency		F <sub>ADCLK</sub>	0.01	-	20	MHz
-0.5dBFS Power Bandwidth		F <sub>BW</sub>	50	-	-	kHz
Input Capacitance (when 1:1 divider is selected (single-ended)) (Note 5)		C <sub>IN</sub>	-	2	-	pF
Gain Error (Note 6)		E <sub>GAIN</sub>	-	±0.75	-	%
Offset Error (Note 6)		E <sub>OFFSET</sub>	-	±15	-	LSB

# ECS640A

## ELECTRICAL CHARACTERISTICS (continued)

Parameter	Test Conditions	Symbol	Min	Typ	Max	Unit
<b>Analog to Digital Converter (ADC)</b>						
Integral Non-Linearity (Note 7)	Differential, gain bypass, 1 V reference	INL	-2.5	-	2.5	LSB
	Differential, 1X gain, 1 V reference		-	±2.5	-	
	Differential, 10X gain, 1 V reference		-	±3.5	-	
	Differential, 1/4 gain, 1 V reference		-	±2	-	
	Single-ended, 1X gain, 1 V reference, 2X $V_{ref}$ Range (Note x6)		-	±2	-	
Differential Non-Linearity (Note 7)	Differential, gain bypass, 1 V reference	DNL	-	-	1.5	LSB
	Differential, 1X gain, 1 V reference		-	1.5	-	
	Differential, 10X gain, 1 V reference		-	2.0	-	
	Differential, 1/4 gain, 1 V reference		-	1.5	-	
	Single-ended, 1X gain, 1 V reference, 2X $V_{ref}$ Range (Note x6)		-	1.5	-	

### GATE DRIVER

#### Low-Side Power Supply Section

Quiescent $V_{DD}$ Supply Current	$V_{LIN1,2,3} = 0\text{ V or }5\text{ V}, EN = 0\text{ V}$	$I_{QDD}$	-	250	400	$\mu\text{A}$
Operating $V_{DD}$ Supply Current	$C_{LOAD} = 1\text{ Nf}, f_{LIN1,2,3} = 20\text{ kHz, rms Value}$	$I_{PDD}$	-	550	750	$\mu\text{A}$
$V_{DD}$ Supply Under-Voltage Positive-Going Threshold	$V_{DD} = \text{Sweep}$	$V_{DDUV+}$	9.7	11.0	12.0	V
$V_{DD}$ Supply Under-Voltage Negative-Going Threshold	$V_{DD} = \text{Sweep}$	$V_{DDUV-}$	9.2	10.5	11.4	V
$V_{DD}$ Supply Under-Voltage Lockout Hysteresis	$V_{DD} = \text{Sweep}$	$V_{DDHYS}$	-	0.5	-	V

#### Bootstrapped Power Supply Section

$V_{BS}$ Supply Under-Voltage Positive-Going Threshold	$V_{BS1,2,3} = \text{Sweep}$	$V_{BSUV+}$	9.7	11.0	12.0	V
$V_{BS}$ Supply Under-Voltage Negative-Going Threshold	$V_{BS1,2,3} = \text{Sweep}$	$V_{BSUV-}$	9.2	10.5	11.4	V
$V_{BS}$ Supply Under-Voltage Lockout Hysteresis	$V_{BS1,2,3} = \text{Sweep}$	$V_{BSHYS}$	-	0.5	-	V
Offset Supply Leakage Current	$V_{S1,2,3} = V_{S1,2,3} = 600\text{ V}$	$I_{LK}$	-	-	10	$\mu\text{A}$
Quiescent $V_{BS}$ Supply Current	$V_{HIN1,2,3} = 0\text{ V or }5\text{ V}, EN = 0\text{ V}$	$I_{QBS}$	10	50	80	$\mu\text{A}$
Operating $V_{BS}$ Supply Current	$C_{LOAD} = 1\text{ nF}, f_{HIN1,2,3} = 20\text{ kHz, rms Value}$	$I_{PBS}$	200	320	480	$\mu\text{A}$

#### Gate Driver Output Section

High-Level Output Voltage, $V_{BIAS} - V_O$	$I_O = 0\text{ mA (No Load)}$	$V_{OH}$	-	-	100	MV
Low-Level Output Voltage, $V_O$	$I_O = 0\text{ mA (No Load)}$	$V_{OL}$	-	-	100	mV
Output HIGH Short-Circuit Pulse Current	$V_O = 15\text{ V}, V_{IN} = 0\text{ V with }PW \leq 10\ \mu\text{s}$	$I_{O+}$	250	350	-	mA
Output LOW Short-Circuit Pulsed Current	$V_O = 0\text{ V}, V_{IN} = 5\text{ V with }PW \leq 10\ \mu\text{s}$	$I_{O-}$	500	650	-	mA
Allowable Negative $V_S$ Pin Voltage for HIN Signal Propagation to HO		$V_S$	-	-9.8	-9.0	V

# ECS640A

## ELECTRICAL CHARACTERISTICS (continued)

Parameter	Test Conditions	Symbol	Min	Typ	Max	Unit
<b>Logic Input Section</b>						
Logic "1" Input Voltage HIN1,2,3, LIN1,2,3		V <sub>IH</sub>	2.5	-	-	V
Logic "0" Input Voltage HIN1,2,3, LIN1,2,3		V <sub>IL</sub>	-	-	0.8	V
Logic Input Bias Current (HO = LO = HIGH)	V <sub>IN</sub> = 5 V	I <sub>IN+</sub>	77	100	143	μA
Logic Input Bias Current (HO = LO = LOW)	V <sub>IN</sub> = 0 V	I <sub>IN-</sub>	-	-	2	μA
Logic Input Pull-Up Resistance		R <sub>IN</sub>	35	50	65	kΩ
<b>Enable Control Section (EN)</b>						
Enable Positive-Going Threshold Voltage		V <sub>EN+</sub>	2.5	-	-	V
Enable Negative-Going Threshold Voltage		V <sub>EN-</sub>	-	-	0.8	V
Logic Enable "1" Input Bias Current	V <sub>EN</sub> = 5 V (Pull-Down = 150 kΩ)	I <sub>EN+</sub>	15	33	50	μA
Logic Enable "0" Input Bias Current	V <sub>EN</sub> = 0 V	I <sub>EN-</sub>	-	-	2	μA
Logic Input Pull-Down Resistance		R <sub>EN</sub>	100	150	333	kΩ
<b>Over-Current Protection Section</b>						
Over-Current Detect Positive Threshold		V <sub>CSSTH+</sub>	450	500	550	mV
Over-Current Detect Negative Threshold		V <sub>CSSTH-</sub>	-	440	-	mV
Over-Current Detect Hysteresis		V <sub>CSHYS</sub>	-	60	-	mV
Short-Circuit Input Current	V <sub>CSIN</sub> = 1 V	I <sub>CSIN</sub>	5	10	15	μA
Soft Turn-Off Sink Current		I <sub>SOFT</sub>	25	40	55	mA
<b>Fault Output Section</b>						
RCIN Positive-Going Threshold Voltage		V <sub>RCINTH+</sub>	2.7	3.3	3.9	V
RCIN Negative-Going Threshold Voltage		V <sub>RCINTH-</sub>	-	2.6	-	V
RCIN Hysteresis Voltage		V <sub>RCINHYS</sub>	-	0.7	-	V
RCIN Internal Current Source	C <sub>RCIN</sub> = 2 nF	I <sub>RCIN</sub>	3	5	7	μA
Fault Output Low Level Voltage	V <sub>CS</sub> = 1 V, I <sub>FO</sub> = 1.5 mA	V <sub>FOL</sub>	-	0.2	0.5	V
RCIN On Resistance	I <sub>RCIN</sub> = 1.5 mA	R <sub>DSRCIN</sub>	50	75	100	Ω
Fault Output On Resistance	I <sub>FO</sub> = 1.5 mA	R <sub>DSFO</sub>	90	130	170	Ω
Turn-On Propagation Delay	V <sub>LIN1,2,3</sub> = V <sub>HIN1,2,3</sub> = 5 V, V <sub>S1,2,3</sub> = 0 V	t <sub>ON</sub>	350	500	650	ns
Turn-Off Propagation Delay	V <sub>LIN1,2,3</sub> = V <sub>HIN1,2,3</sub> = 0 V, V <sub>S1,2,3</sub> = 0 V	t <sub>OFF</sub>	350	500	650	ns
Turn-On Rise Time	V <sub>LIN1,2,3</sub> = V <sub>HIN1,2,3</sub> = 5 V	t <sub>R</sub>	20	50	100	ns
Turn-Off Fall Time	V <sub>LIN1,2,3</sub> = V <sub>HIN1,2,3</sub> = 0 V	t <sub>F</sub>	10	30	80	ns
Enable LOW to Output Shutdown Delay		t <sub>EN</sub>	400	500	600	ns
CS Pin Leading-Edge Blanking Time		t <sub>CSBLT</sub>	400	650	850	ns
Time from CS Triggering to FO	From V <sub>CSC</sub> = 1 V to FO Turn-Off	t <sub>CSFO</sub>	-	850	1300	ns

# ECS640A

## ELECTRICAL CHARACTERISTICS (continued)

Parameter	Test Conditions	Symbol	Min	Typ	Max	Unit
<b>Fault Output Section</b>						
Time from CS Triggering to Low-Side Gate Outputs Turn-Off	From $V_{CSC} = 1\text{ V}$ to Starting Gate Turn-Off	$t_{CSOFF}$	-	850	1300	ns
Input Filtering Time (Note 7) (HINx, LINx, EN)		$t_{FLTIN}$	170	250	330	ns
Fault-Clear Time		$t_{FLTCLR}$	-	1.3	2.35	ns
Dead Time		DT	230	320	400	ns
Dead-Time Matching (All Six Channels) (Note 8)		MDT	-	-	50	ns
Delay Matching (All Six Channels) (Note 9)		MT	-	-	50	ns
Output Pulse-Width Matching (Note 10)	$PW_{IN} > 1\ \mu\text{s}$	PM	-	50	100	ns

### BOOTSTRAP DIODES

Forward Voltage	$I_F = 0.1\text{ A}$ , $T_A = 25^\circ\text{C}$	$V_F$	-	2.5	-	V
Reverse-Recovery Time	$I_F = 0.1\text{ A}$ , $T_A = 25^\circ\text{C}$	$t_{rr}$	-	80	-	ns

### CURRENT SENSOR AMPLIFIER ( $V_S = 1.8\text{ V}$ , $T_A = +25^\circ\text{C}$ )

#### Input Characteristics

Input Offset Voltage		$V_{OS}$	-	-	5.0	mV
Offset Voltage Drift		$\Delta V_{OS}/\Delta T$	-	2.0	6.0	$\mu\text{V}/^\circ\text{C}$
Input Bias Current		$I_{IB}$	-	1	-	pA
Input Offset Current		$I_{OS}$	-	1	-	pA
Channel Separation		XTLK	-	100	-	dB
Input Resistance		$R_{IN}$	-	1	-	$\text{T}\Omega$
Input Capacitance		$C_{IN}$	-	1.2	-	pF
Common Mode Rejection Ratio	$V_{IN} = V_{SS}$ to $V_{DD} - 0.6\text{ V}$	CMRR	70	80	-	dB
	$V_{IN} = V_{SS} + 0.2\text{ V}$ to $V_{DD} - 0.6\text{ V}$		65	-	-	

#### Output Characteristics

Open Loop Voltage Gain	$R_L = 10\text{ k}\Omega$	$A_{VOL}$	75	92	-	dB
	$R_L = 2\text{ k}\Omega$		70	92	-	
Output Current Capability	Sourcing	$I_{SC}$	5	8	-	mA
	Sinking		10	14	-	
Output Voltage High	$R_L = 10\text{ k}\Omega$	$V_{OH}$	1.75	1.798	-	V
	$R_L = 2\text{ k}\Omega$		1.7	1.78	-	
Output Voltage Low	$R_L = 10\text{ k}\Omega$	$V_{OL}$	-	7	100	mV
	$R_L = 2\text{ k}\Omega$		-	20	100	

#### Noise Performance

Voltage Noise Density	$f = 1\text{ kHz}$	$e_N$	-	20	-	nV/
Current Noise Density	$f = 1\text{ kHz}$	$i_N$	-	0.1	-	pA/

#### Dynamic Performance

Gain Bandwidth Product		GBWP	-	5	-	MHz
Slew Rate at Unity Gain	Rising Edge, $R_L = 2\text{ k}\Omega$ , $A_V = +1$	SR	-	6	-	$\text{V}/\mu\text{s}$
	Falling Edge, $R_L = 2\text{ k}\Omega$ , $A_V = +1$		-	9	-	
Phase Margin	$R_L = 10\text{ k}\Omega$ , $C_L = 5\text{ pF}$	$\Psi_m$	-	53	-	$^\circ$
Gain Margin	$R_L = 10\text{ k}\Omega$ , $C_L = 5\text{ pF}$	$A_m$	-	8	-	dB
Settling Time	$V_O = 1\text{ V}_{pp}$ , Gain = 1, $C_L = 20\text{ pF}$ , Settling time to 0.1%	$t_s$	-	1.8	-	$\mu\text{s}$

# ECS640A

## ELECTRICAL CHARACTERISTICS (continued)

Parameter	Test Conditions	Symbol	Min	Typ	Max	Unit
-----------	-----------------	--------	-----	-----	-----	------

### Dynamic Performance

Total Harmonics Distortion + Noise	$V_O = 1 V_{pp}$ , $R_L = 2 k\Omega$ , $A_V = +1$ , $f = 1 kHz$	THD+N	-	0.005	-	%
	$V_O = 1 V_{pp}$ , $R_L = 2 k\Omega$ , $A_V = +1$ , $f = 10 kHz$		-	0.025	-	

### Power Supply

Power Supply Rejection Ratio		PSRR	80	100	-	dB
Quiescent Current	No load, per channel	$I_{DD}$	-	275	575	$\mu A$

Product parametric performance is indicated in the Electrical Characteristics for the listed test conditions, unless otherwise noted. Product performance may not be indicated by the Electrical Characteristics if operated under different conditions.

5. Refer to ELECTRICAL CHARACTERISTICS, RECOMMENDED OPERATING RANGES and/or APPLICATION INFORMATION for Safe Operating parameters.

6. Values based on copper area of 645 mm<sup>2</sup> (or 1 in<sup>2</sup>) of 1 oz copper thickness and FR4 PCB substrate.

7. The minimum width of the input pulse should exceed 500 ns to ensure the filtering time of the input filter is exceeded.

8. MDT is defined as  $|DT1 - DT2|$  referenced to 0.

9. MT is defined as an absolute value of matching delay time between High-side and Low-side.

10. PM is defined as an absolute value of matching pulse-width between Input and Output.

## ORDERING INFORMATION

Device	Package	Shipping <sup>†</sup>
NFMECS640A0	WQFN65 13 × 10, 0.5P (Pb-Free)	3000 / Tape & Reel

<sup>†</sup>For information on tape and reel specifications, including part orientation and tape sizes, please refer to our Tape and Reel Packaging Specifications Brochure, [BRD8011/D](#).

# MECHANICAL CASE OUTLINE PACKAGE DIMENSIONS

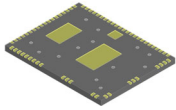

## GAQFN65 13x10, 0.5P CASE 510CT ISSUE C

DATE 14 DEC 2021

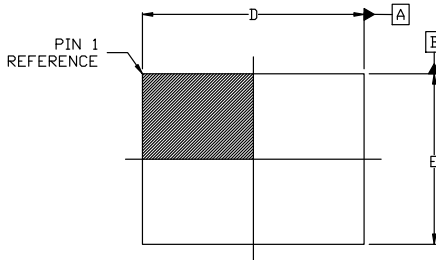

TOP VIEW

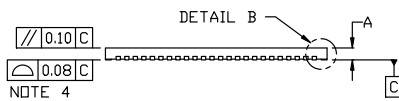

SIDE VIEW

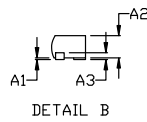

DETAIL B

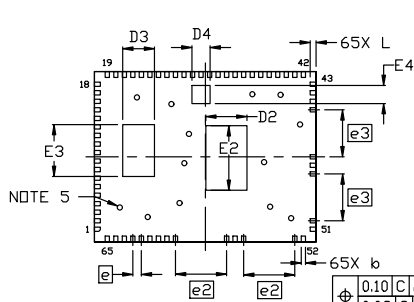

BOTTOM VIEW

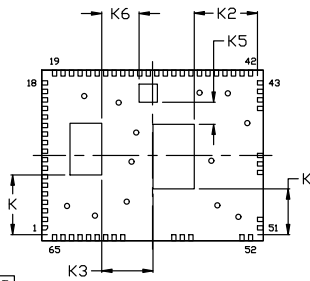

BOTTOM VIEW  
(SUPPLEMENTAL)

DIM	MILLIMETERS		
	MIN.	NDM.	MAX.
A	0.70	0.75	0.80
A1	0.00	---	0.05
A2	0.65 REF		
A3	0.10 REF		
b	0.20	0.25	0.30
D	12.90	13.00	13.10
D2	2.31	2.41	2.51
D3	1.76	1.86	1.96
D4	0.98	1.08	1.18
E	9.90	10.00	10.10
E2	3.69	3.79	3.89
E3	2.94	3.04	3.14

DIM	MILLIMETERS		
	MIN.	NDM.	MAX.
E4	0.96	1.06	1.16
e	0.50 BSC		
e2	3.00 BSC		
e3	2.75 BSC		
K	3.50 REF		
K2	3.72 REF		
K3	3.00 REF		
K4	2.68 REF		
K5	1.30 REF		
K6	2.20 REF		
L	0.25	0.35	0.45

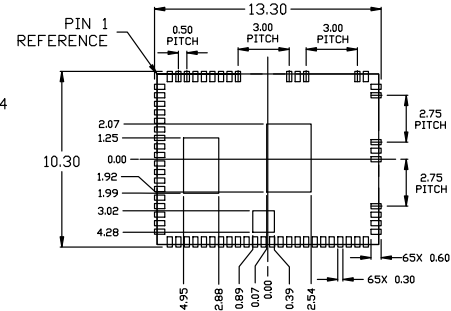

RECOMMENDED  
MOUNTING FOOTPRINT\*

\* For additional information on our Pb-Free strategy and soldering details, please download the DN Semiconductor Soldering and Mounting Techniques Reference Manual, SLDLERRM/D.

### GENERIC MARKING DIAGRAM\*

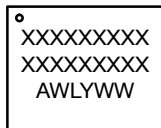

XXXX = Specific Device Code  
A = Assembly Location  
WL = Wafer Lot  
Y = Year  
WW = Work Week

\*This information is generic. Please refer to device data sheet for actual part marking. Pb-Free indicator, "G" or microdot "μ", may or may not be present. Some products may not follow the Generic Marking.

<b>DOCUMENT NUMBER:</b>	<b>98AON25842H</b>	Electronic versions are uncontrolled except when accessed directly from the Document Repository. Printed versions are uncontrolled except when stamped "CONTROLLED COPY" in red.
<b>DESCRIPTION:</b>	<b>GAQFN65 13x10, 0.5P</b>	<b>PAGE 1 OF 1</b>

onsemi and ONSEMI are trademarks of Semiconductor Components Industries, LLC dba onsemi or its subsidiaries in the United States and/or other countries. onsemi reserves the right to make changes without further notice to any products herein. onsemi makes no warranty, representation or guarantee regarding the suitability of its products for any particular purpose, nor does onsemi assume any liability arising out of the application or use of any product or circuit, and specifically disclaims any and all liability, including without limitation special, consequential or incidental damages. onsemi does not convey any license under its patent rights nor the rights of others.

**onsemi**, **Onsemi**, and other names, marks, and brands are registered and/or common law trademarks of Semiconductor Components Industries, LLC dba "**onsemi**" or its affiliates and/or subsidiaries in the United States and/or other countries. **onsemi** owns the rights to a number of patents, trademarks, copyrights, trade secrets, and other intellectual property. A listing of **onsemi**'s product/patent coverage may be accessed at [www.onsemi.com/site/pdf/Patent-Marking.pdf](http://www.onsemi.com/site/pdf/Patent-Marking.pdf). **onsemi** reserves the right to make changes at any time to any products or information herein, without notice. The information herein is provided "as-is" and **onsemi** makes no warranty, representation or guarantee regarding the accuracy of the information, product features, availability, functionality, or suitability of its products for any particular purpose, nor does **onsemi** assume any liability arising out of the application or use of any product or circuit, and specifically disclaims any and all liability, including without limitation special, consequential or incidental damages. Buyer is responsible for its products and applications using **onsemi** products, including compliance with all laws, regulations and safety requirements or standards, regardless of any support or applications information provided by **onsemi**. "Typical" parameters which may be provided in **onsemi** data sheets and/or specifications can and do vary in different applications and actual performance may vary over time. All operating parameters, including "Typicals" must be validated for each customer application by customer's technical experts. **onsemi** does not convey any license under any of its intellectual property rights nor the rights of others. **onsemi** products are not designed, intended, or authorized for use as a critical component in life support systems or any FDA Class 3 medical devices or medical devices with a same or similar classification in a foreign jurisdiction or any devices intended for implantation in the human body. Should Buyer purchase or use **onsemi** products for any such unintended or unauthorized application, Buyer shall indemnify and hold **onsemi** and its officers, employees, subsidiaries, affiliates, and distributors harmless against all claims, costs, damages, and expenses, and reasonable attorney fees arising out of, directly or indirectly, any claim of personal injury or death associated with such unintended or unauthorized use, even if such claim alleges that **onsemi** was negligent regarding the design or manufacture of the part. **onsemi** is an Equal Opportunity/Affirmative Action Employer. This literature is subject to all applicable copyright laws and is not for resale in any manner.

## ADDITIONAL INFORMATION

### TECHNICAL PUBLICATIONS:



Technical Library: [www.onsemi.com/design/resources/technical-documentation](http://www.onsemi.com/design/resources/technical-documentation)  
onsemi Website: [www.onsemi.com](http://www.onsemi.com)

### ONLINE SUPPORT: [www.onsemi.com/support](http://www.onsemi.com/support)

For additional information, please contact your local Sales Representative at [www.onsemi.com/support/sales](http://www.onsemi.com/support/sales)

## Looking for pricing, stock, or lifecycle information?

Click below to explore more details on WIN SOURCE:

-  [View NFMECS640A0](#) on WIN SOURCE
-  [ON Semiconductor](#) Information

## Optimize Your Supply Chain with WIN SOURCE Solutions

-  Global Sourcing Solution
-  Obsolete Management
-  Cost Control Management
-  Shortage Management
-  Alternative Solution
-  Excess Inventory Management