

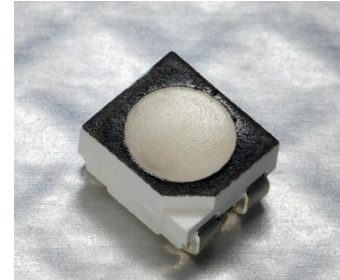

**THE DATASHEET OF
CLV1A-FKB-CK1N1G1BB7R4S3**



Cree® PLCC4 3 in 1 SMD LED CLV1A-FKB



PRODUCT DESCRIPTION

Cree PLCC full-color LEDs offer high-intensity light output and a wide viewing angle in an industry-standard package. Designed to work in a wide array of environmental conditions, Cree PLCC full-color LEDs are suited for indoor video screen, decorative lighting and amusement applications.

FEATURES

- Size (mm): 3.2 x 2.8
- Dominant Wavelength:
Red (619 - 624nm)
Green (520 - 540nm)
Blue (460 - 480nm)
- Luminous Intensity (mcd)
Red (355 - 900)
Green (560 - 1400)
Blue (180 - 505)
- Moisture Sensitivity Level: 5a
- Lead-Free
- RoHS Compliant

APPLICATIONS

- Full-Color Video Screen
- Decorative lighting
- Amusement

ABSOLUTE MAXIMUM RATINGS ($T_A = 25^\circ\text{C}$)

Items	Symbol	Absolute Maximum Rating			Unit
		R	G	B	
Forward Current ^{Note 1}	I_F	50	25	25	mA
Peak Forward Current ^{Note 2}	I_{FP}	200	100	100	mA
Reverse Voltage	V_R	5	5	5	V
Power Dissipation	P_D	130	100	100	mW
Operation Temperature	T_{opr}	-40 ~ +100			$^\circ\text{C}$
Storage Temperature	T_{stg}	-40 ~ +100			$^\circ\text{C}$
Junction Temperature	T_J	110	110	110	$^\circ\text{C}$
Junction/ambient 1 chip on	R_{THJA}	450	400	450	$^\circ\text{C}/\text{W}$
Junction/ambient 3 chips on	R_{THJA}	650	580	680	$^\circ\text{C}/\text{W}$
Junction/solder point 1 chip on	R_{THJS}	300	280	300	$^\circ\text{C}/\text{W}$
Junction/solder point 3 chips on	R_{THJS}	450	430	480	$^\circ\text{C}/\text{W}$

Note: 1.Single-color light.
2.Pulse width ≤ 0.1 msec, duty $\leq 1/10$.

TYPICAL ELECTRICAL & OPTICAL CHARACTERISTICS ($T_A = 25^\circ\text{C}$)

Characteristics	Condition	Symbol	Values			Unit
			R	G	B	
Dominant Wavelength	$I_F = 20$ mA	λ_{DOM}	619~624	520~540	460~480	nm
Spectral bandwidth at 50% I_{REL} max	$I_F = 20$ mA	$\Delta \lambda$	24	38	28	nm
Forward Voltage	$I_F = 20$ mA	$V_{F(avg)}$	2.0	3.2	3.2	V
		$V_{F(max)}$	2.6	4.0	4.0	V
Luminous Intensity	$I_F = 20$ mA	$I_{V(min)}$	355	560	180	mcd
		$I_{V(avg)}$	550	850	320	mcd
Reverse Current (max)	$V_R = 5$ V	I_R	10	10	10	μA

INTENSITY BIN LIMIT ($I_F = 20 \text{ mA}$)

Red

Bin Code	Min.(mcd)	Max.(mcd)
H	355	450
hj	403	505
J	450	560
km	505	635
K	560	710
np	635	805
M	710	900

Green

Bin Code	Min.(mcd)	Max.(mcd)
K	560	710
np	635	805
M	710	900
qr	805	1010
N	900	1120
st	1010	1260
P	1120	1400

Blue

Bin Code	Min.(mcd)	Max.(mcd)
E	180	224
bc	202	252
F	224	280
de	252	318
G	280	355
fg	318	403
H	355	450
hj	403	505

Tolerance of measurement of luminous intensity is $\pm 10\%$.

COLOR BIN LIMIT ($I_F = 20 \text{ mA}$)

Red

Bin Code	Min.(nm)	Max.(nm)
RB	619	624

Green

Bin Code	Min.(nm)	Max.(nm)
G7	520	525
G23	522.5	527.5
G8	525	530
G45	527.5	532.5
G9	530	535
G67	532.5	537.5
Ga	535	540

Blue

Bin Code	Min.(nm)	Max.(nm)
B3	460	465
B23	462.5	467.5
B4	465	470
B45	467.5	472.5
B5	470	475
B67	472.5	477.5
B6	475	480

Tolerance of measurement of dominant wavelength is $\pm 1 \text{ nm}$.

ORDER CODE TABLE*

Kit Number	Color	Luminous Intensity (mcd)		Dominant Wavelength (nm)				Package
		Min.	Max.	Color Bin	Min. (nm)	Color Bin	Max. (nm)	
CLV1A-FKB-CHMKPEHBB7a363	Red	355	900	RB	619	RB	624	Reel
	Green	560	1400	G7	520	Ga	540	Reel
	Blue	180	450	B3	460	B6	480	Reel
CLV1A-FKB-CHMKPEHBB7a463	Red	355	900	RB	619	RB	624	Reel
	Green	560	1400	G7	520	Ga	540	Reel
	Blue	180	450	B4	465	B6	480	Reel
CLV1A-FKB-CH1K1E1BB7R3S3	Red	Any 1 Intensity bin from H(355) - K(710)		RB	619	RB	624	Reel
	Green	Any 1 Intensity bin from K(560) - N(1120)		Any 1 hue bin from G7(520) - Ga(540)			Reel	
	Blue	Any 1 Intensity bin from E(180) - G(355)		Any 1 hue bin from B3(460) - B5(475)			Reel	
CLV1A-FKB-CH1K1E1BB7R4S3	Red	Any 1 Intensity bin from H(355) - K(710)		RB	619	RB	624	Reel
	Green	Any 1 Intensity bin from K(560) - N(1120)		Any 1 hue bin from G7(520) - Ga(540)			Reel	
	Blue	Any 1 Intensity bin from E(180) - G(355)		Any 1 hue bin from B4(465) - B6(480)			Reel	
CLV1A-FKB-CJ1M1F1BB7R3S3	Red	Any 1 Intensity bin from J(450) - M(900)		RB	619	RB	624	Reel
	Green	Any 1 Intensity bin from M(710) - P(1400)		Any 1 hue bin from G7(520) - Ga(540)			Reel	
	Blue	Any 1 Intensity bin from F(224) - H(450)		Any 1 hue bin from B3(460) - B5(475)			Reel	
CLV1A-FKB-CJ1M1F1BB7R4S3	Red	Any 1 Intensity bin from J(450) - M(900)		RB	619	RB	624	Reel
	Green	Any 1 Intensity bin from M(710) - P(1400)		Any 1 hue bin from G7(520) - Ga(540)			Reel	
	Blue	Any 1 Intensity bin from F(224) - H(450)		Any 1 hue bin from B4(465) - B6(480)			Reel	
CLV1A-FKB-CK1N1G1BB7R4S3	Red	Any 1 Intensity bin from K(560) - M(900)		RB	619	RB	624	Reel
	Green	Any 1 Intensity bin from N(900) - P(1400)		Any 1 hue bin from G7(520) - Ga(540)			Reel	
	Blue	Any 1 Intensity bin from G(280) - H(450)		Any 1 hue bin from B4(465) - B6(480)			Reel	

Notes:

1. The above kit numbers represent the order codes which include multiple intensity-bin and color-bin codes. Only one intensity-bin code and one color-bin code will be shipped on each reel. Single intensity-bin code and single color-bin code will be orderable in certain quantities. For example, any 1 intensity bin from H - M means only 1 intensity bin (H or J or K or M) will be shipped by Cree. For example, any 1 color bin from G7 - Ga means only 1 color bin (G7 or G8 or G9 or Ga) will be shipped by Cree.
2. Please refer to the "Cree LED Lamp Reliability Test Standards" document for reliability test conditions.
3. Please refer to the "Cree LED Lamp Soldering & Handling" document for information about how to use this LED product safely.

GRAPHS

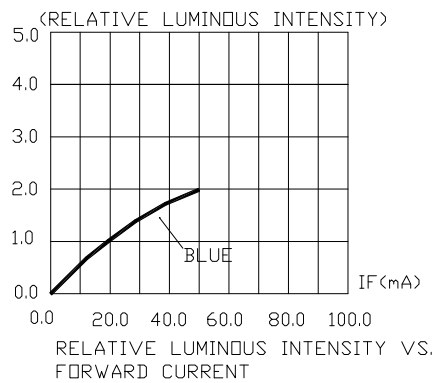
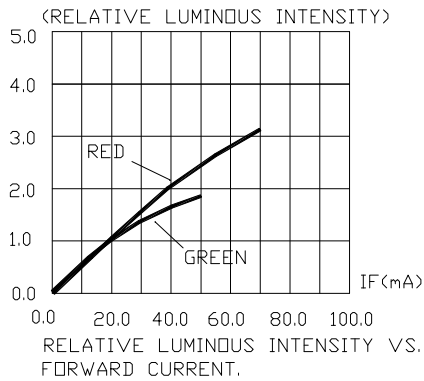
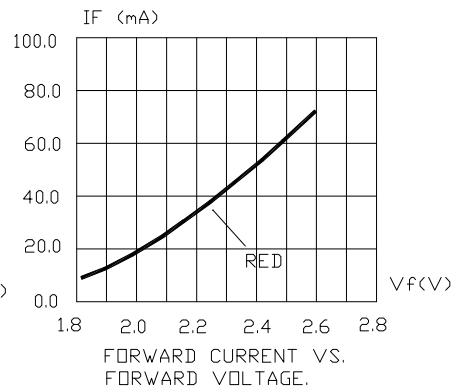
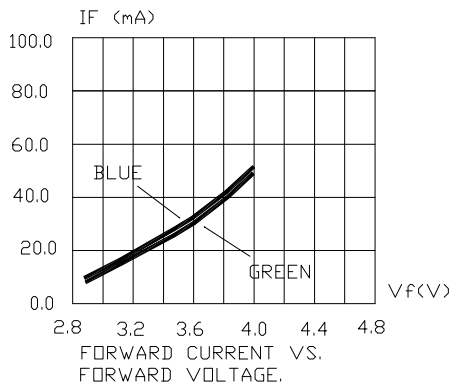
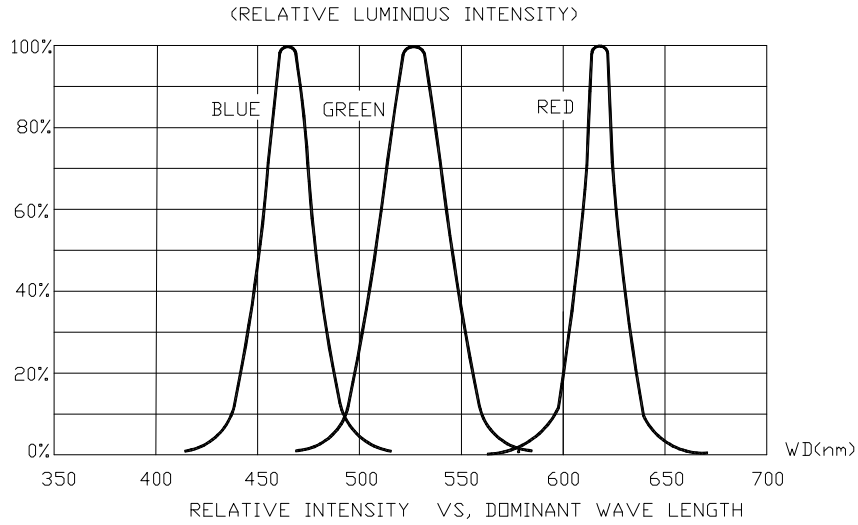

The above data are collected from statistical figures that do not necessarily correspond to the actual parameters of each single LED. Hence, these data will be changed without further notice.

GRAPHS

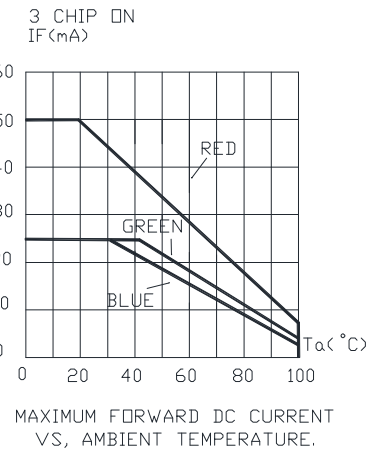
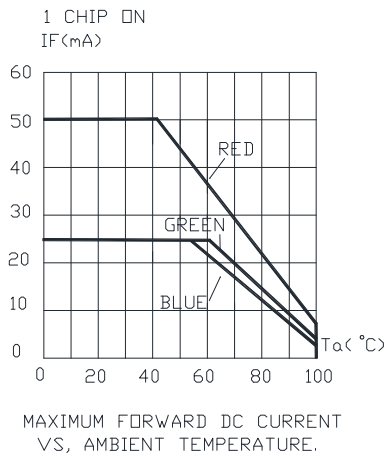
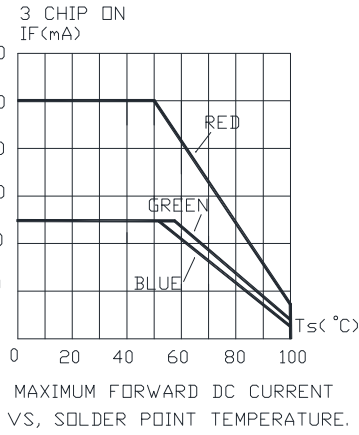
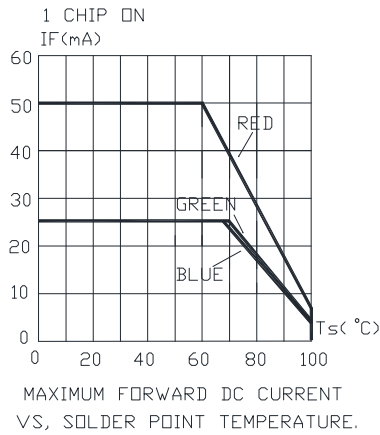
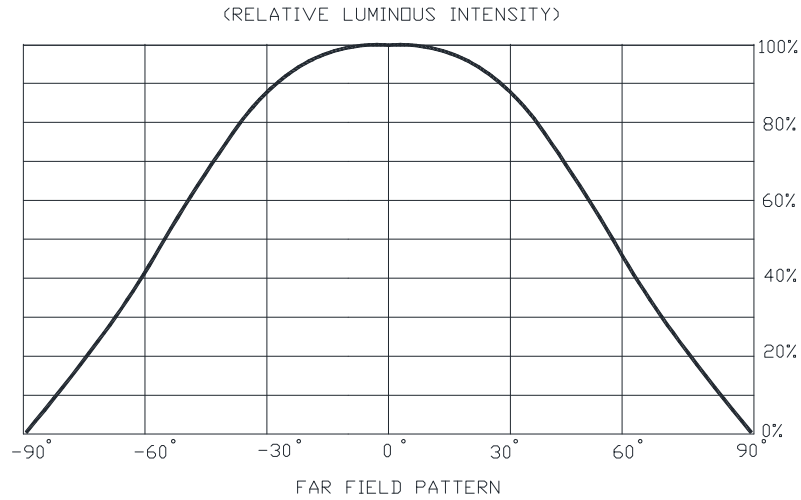

The above data are collected from statistical figures that do not necessarily correspond to the actual parameters of each single LED. Hence, these data will be changed without further notice.

MECHANICAL DIMENSIONS

All dimensions are in mm.

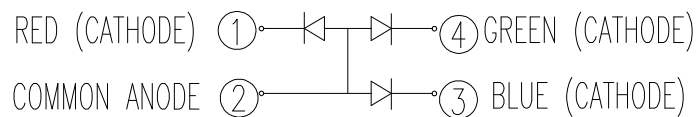
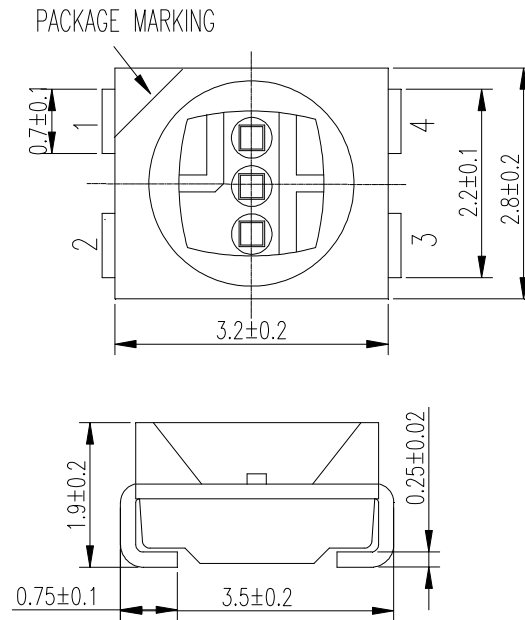

NOTES

RoHS Compliance

The levels of environmentally sensitive, persistent biologically toxic (PBT), persistent organic pollutants (POP), or otherwise restricted materials in this product are below the maximum concentration values (also referred to as the threshold limits) permitted for such substances, or are used in an exempted application, in accordance with EU Directive 2002/95/EC on the restriction of the use of certain hazardous substances in electrical and electronic equipment (RoHS), as amended through April 21, 2006.

Vision Advisory Claim

Users should be cautioned not to stare at the light of this LED product. The bright light can damage the eye.

KIT NUMBER SYSTEM

Cree LED lamps are tested and sorted into performance bins. A bin is specified by ranges of color, forward voltage, and brightness. Sorted LEDs are packaged for shipping in various convenient options. Please refer to the "Cree LED Lamp Packaging Standard" document for more information about shipping and packaging options.

Cree LEDs are sold by order codes in combinations of bins called kits. Order codes are configured in the following manner:

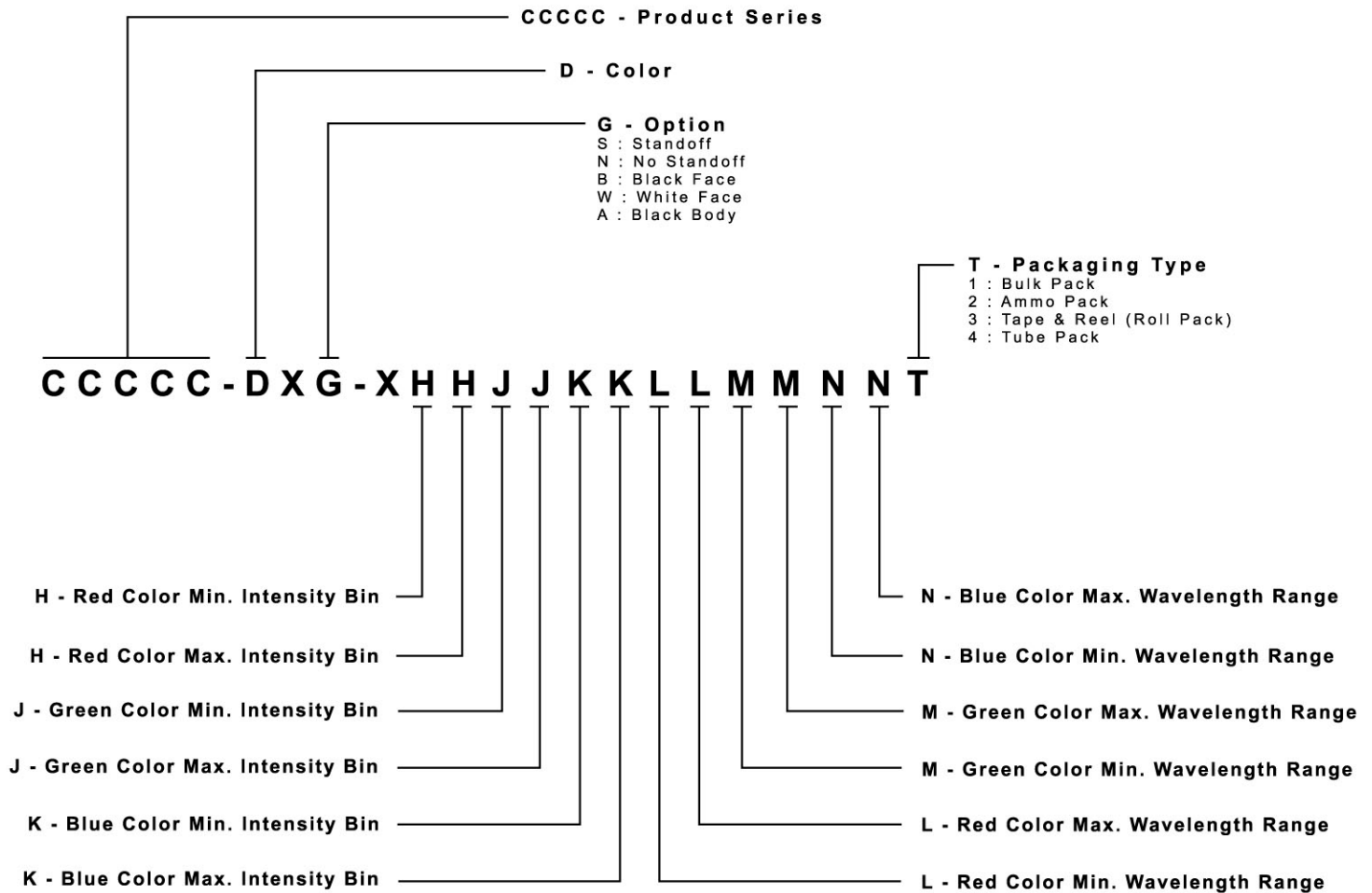

PACKAGING

- The CLV1A-FKB is rated as a MSL 5a product.
- The boxes are not water resistant and they must be kept away from water and moisture.
- The LEDs are packed in cardboard boxes after packaging in normal or anti-electrostatic bags.
- Cardboard boxes will be used to protect the LEDs from mechanical shocks during transportation.
- The reel pack is applied in SMD LED.
- Max 2000 pcs per reel.

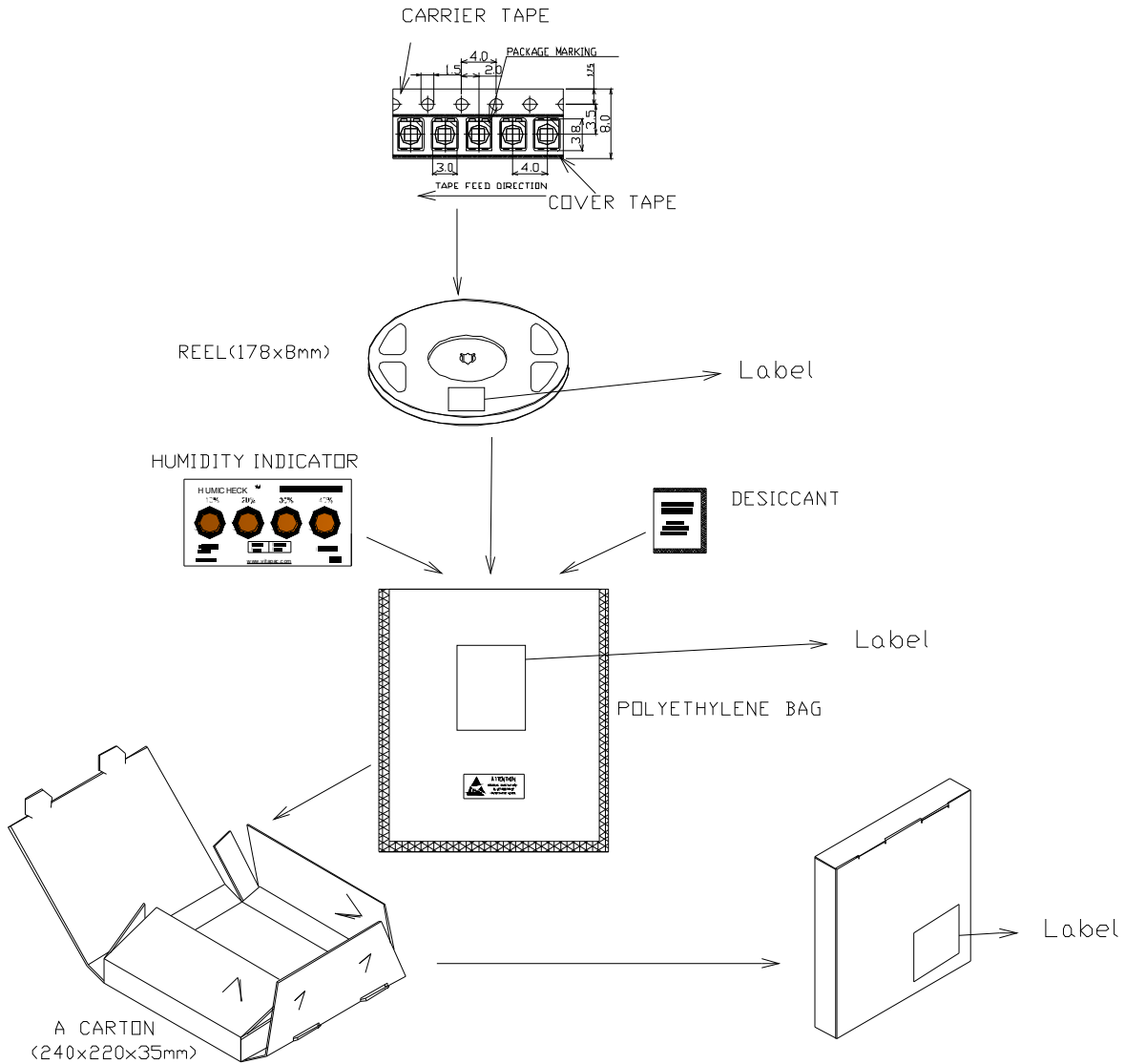

Looking for pricing, stock, or lifecycle information?

Click below to explore more details on WIN SOURCE:

 [View CLV1A-FKB-CK1N1G1BB7R4S3 on WIN SOURCE](#)

 [CreeLED, Inc. Information](#)

Optimize Your Supply Chain with WIN SOURCE Solutions

-  Global Sourcing Solution
-  Obsolete Management
-  Cost Control Management
-  Shortage Management
-  Alternative Solution
-  Excess Inventory Management