



**THE DATASHEET OF  
IRS2007SPBF**



## 200-V half-bridge gate driver IC with $V_{CC}$ & $V_{BS}$ UVLO

### Features

- Gate drive supplies up to 20 V per channel
- Undervoltage lockout for  $V_{CC}$ ,  $V_{BS}$
- 3.3 V, 5 V, 15 V input logic compatible
- Tolerant to negative transient voltage
- Designed for use with bootstrap power supplies
- Cross-conduction prevention logic
- Matched propagation delay for both channels
- Internal set deadtime
- High-side output in phase with  $\overline{HIN}$  input
- Low-side output out of phase with  $\overline{LIN}$  input
- -40°C to 125°C operating range
- 2 kV HBM ESD
- RoHS compliant

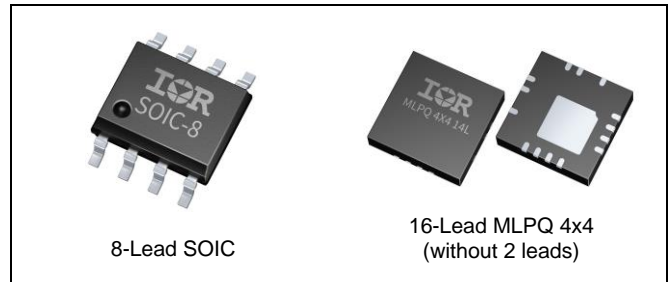
### Description

The IRS2007 is a high voltage, high speed power MOSFET and IGBT driver with dependent high and low side referenced output channels. Proprietary HVIC and latch immune CMOS technologies enable ruggedized monolithic construction. The logic input is compatible with standard CMOS or LSTTL output, down to 3.3 V logic. The output drivers feature a high pulse current buffer stage designed for minimum driver cross-conduction. The floating channel can be used to drive an N-channel power MOSFET or IGBT in the high side configuration which operates up to 200 V. Propagation delays are matched to simplify the HVIC's use in high frequency applications.

### Product Summary

$V_{OFFSET}$	$\leq 200$ V
$V_{OUT}$	10 V – 20 V
$I_{o+}$ & $I_{o-}$ (typ.)	290 mA & 600 mA
$t_{ON}$ & $t_{OFF}$ (typ.)	160 ns & 150 ns
Deadtime (typ.)	520 ns

### Package Options

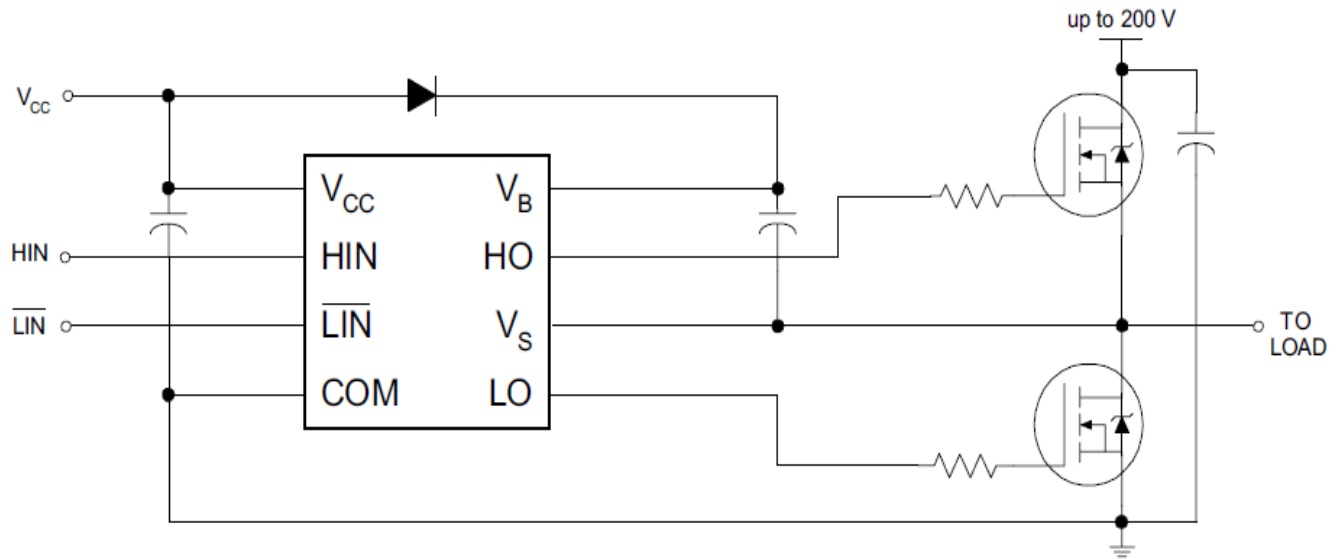


### Typical Applications

- Appliance motor drives, Stepper motor, Servo drives
- Micro inverter drives
- General purpose three phase inverters
- Light electric vehicles (e-bikes, e-scooters, e-toys)
- Wireless Charging
- General battery driven applications

Base Part Number	Package Type	Standard Pack		Orderable Part Number
		Form	Quantity	
<a href="#">IRS2007S</a>	8-Lead SOIC	Tape and Reel	2500	IRS2007STRPBF
		Tube/Bulk	95	IRS2007SPBF
<a href="#">IRS2007M</a>	14-Lead MLPQ 4x4	Tape and Reel	3000	IRS2007MTRPBF

**Typical Connection Diagram**



(Refer to Lead Assignments for correct pin configuration). This diagram shows electrical connections only. Please refer our Application Notes & DesignTips for proper circuit board layout.

## Absolute Maximum Ratings

Absolute maximum ratings indicate sustained limits beyond which damage to the device may occur. All voltage parameters are absolute voltages referenced to COM unless otherwise stated in the table. The thermal resistance and power dissipation ratings are measured under board mounted and still air conditions.

Symbol	Definition	Min.	Max.	Units	
V <sub>CC</sub>	Low side supply voltage	-0.3	25 <sup>†</sup>	V	
V <sub>IN</sub>	Logic input voltage (HIN & L $\bar{I}$ N)	COM - 0.3	V <sub>CC</sub> + 0.3		
V <sub>B</sub>	High-side floating well supply voltage	-0.3	225		
V <sub>S</sub>	High-side floating well supply return voltage	V <sub>B</sub> - 25	V <sub>B</sub> + 0.3		
V <sub>HO</sub>	Floating gate drive output voltage	V <sub>S</sub> - 0.3	V <sub>B</sub> + 0.3		
V <sub>LO</sub>	Low-side output voltage	COM - 0.3	V <sub>CC</sub> + 0.3		
COM	Power ground	V <sub>CC</sub> - 25	V <sub>CC</sub> + 0.3		
dV <sub>S</sub> /dt	Allowable V <sub>S</sub> offset supply transient relative to COM	—	50	V/ns	
P <sub>D</sub>	Package power dissipation @ T <sub>A</sub> ≤ +25°C	8-Lead SOIC	—	0.625	W
		14-Lead MLPQ 4x4	—	2.08	
R <sub>thJA</sub>	Thermal resistance, junction to ambient	8-Lead SOIC	—	200	°C/W
		14-Lead MLPQ 4x4	—	36	
T <sub>J</sub>	Junction temperature	—	150	°C	
T <sub>S</sub>	Storage temperature	-55	150		
T <sub>L</sub>	Lead temperature (soldering, 10 seconds)	—	300		

† All supplies are tested at 25 V.

## Recommended Operating Conditions

For proper operation, the device should be used within the recommended conditions. All voltage parameters are absolute voltages referenced to COM unless otherwise stated in the table. The offset rating is tested with supplies of (V<sub>CC</sub> - COM) = (V<sub>B</sub> - V<sub>S</sub>) = 15V.

Symbol	Definition	Min	Max	Units
V <sub>CC</sub>	Low-side supply voltage	10	20	V
V <sub>IN</sub>	Logic input voltage	0	V <sub>CC</sub>	
V <sub>B</sub>	High-side floating well supply voltage	V <sub>S</sub> + 10	V <sub>S</sub> + 20	
V <sub>S</sub>	High-side floating well supply offset voltage <sup>†</sup>	COM - 8 <sup>†</sup>	200	
V <sub>HO</sub>	Floating gate drive output voltage	V <sub>S</sub>	V <sub>B</sub>	
V <sub>LO</sub>	Low-side output voltage	COM	V <sub>CC</sub>	
T <sub>A</sub>	Ambient temperature	-40	125	°C

† Logic operation for V<sub>S</sub> of -8 V to 200 V. Logic state held for V<sub>S</sub> of -8 V to -V<sub>BS</sub>. Please refer to Design Tip DT97-3 for more details.

### Static Electrical Characteristics

( $V_{CC} - COM$ ) = ( $V_B - V_S$ ) = 15V.  $T_A = 25^\circ\text{C}$  unless otherwise specified. The  $V_{IN}$  and  $I_{IN}$  parameters are referenced to COM. The  $V_O$  and  $I_O$  parameters are referenced to respective  $V_S$  and COM and are applicable to the respective output leads HO or LO. The  $V_{CCUV}$  parameters are referenced to COM. The  $V_{BSUV}$  parameters are referenced to  $V_S$ .

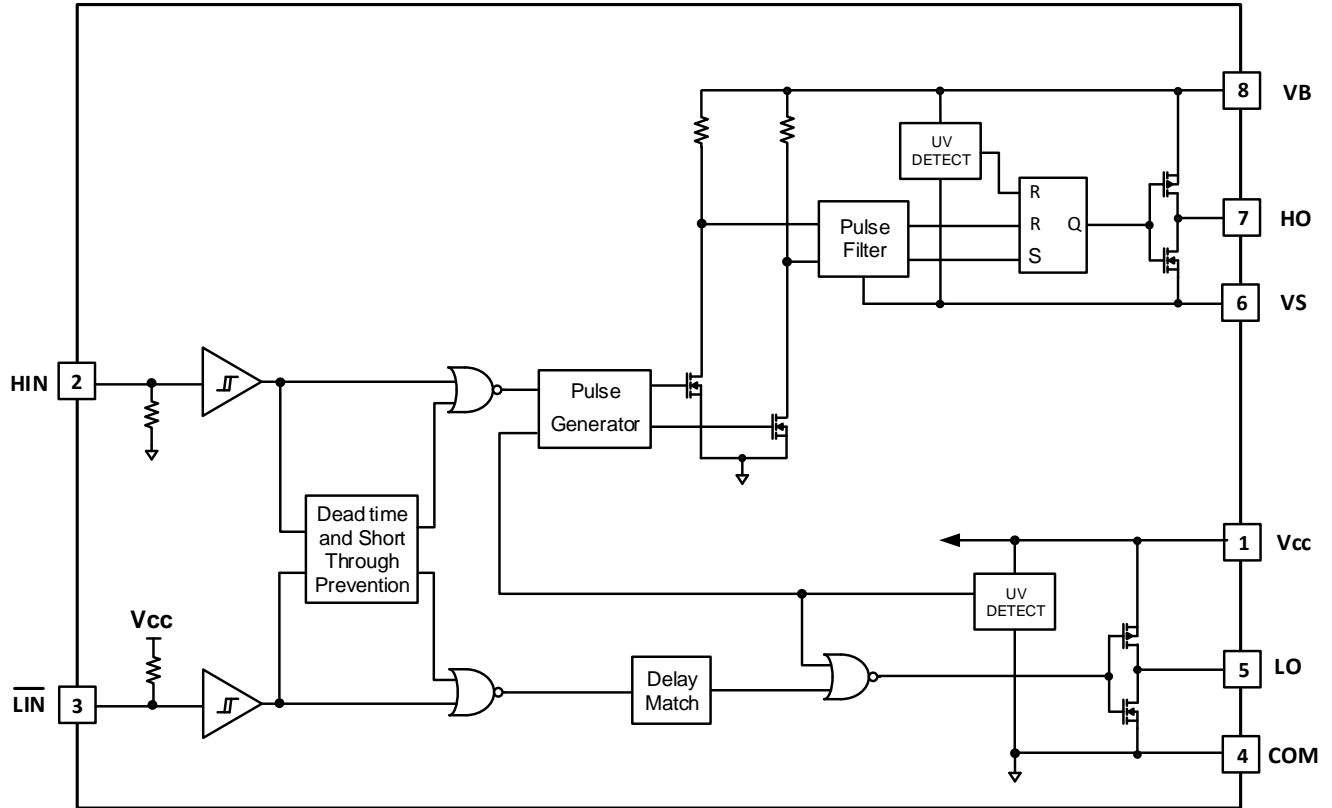
Symbol	Definition	Min.	Typ.	Max.	Units	Test Conditions
$V_{BSUV+}$	$V_{BS}$ supply undervoltage positive going threshold	8.0	8.9	9.8	V	
$V_{BSUV-}$	$V_{BS}$ supply undervoltage negative going threshold	7.4	8.2	9		
$V_{BSUVHY}$	$V_{BS}$ supply undervoltage hysteresis	—	0.7	—		
$V_{CCUV+}$	$V_{CC}$ supply undervoltage positive going threshold	8.0	8.9	9.8		
$V_{CCUV-}$	$V_{CC}$ supply undervoltage negative going threshold	7.4	8.2	9		
$V_{CCUVHY}$	$V_{CC}$ supply undervoltage hysteresis	—	0.7	—		
$I_{LK}$	High-side floating well offset supply leakage	—	—	50	$\mu\text{A}$	$V_B = V_S = 200\text{V}$
$I_{QBS}$	Quiescent $V_{BS}$ supply current	—	45	75		All inputs are in the off state
$I_{QCC}$	Quiescent $V_{CC}$ supply current	—	300	520		
$V_{OH}$	High level output voltage drop, $V_{BIAS}-V_O$	—	0.05	0.2	V	$I_O = 2\text{ mA}$
$V_{OL}$	Low level output voltage drop, $V_O$	—	0.02	0.1		
$I_{O+}$	Output high short circuit pulsed current	200	290	—	mA	$V_O = 0\text{V}$ , $V_{IN} = V_{IH}$ $PW \leq 10\mu\text{s}$
$I_{O-}$	Output low short circuit pulsed current	420	600	—		$V_O = 15\text{V}$ , $V_{IN} = V_{IL}$ $PW \leq 10\mu\text{s}$
$V_{IH}$	Logic "1" (HIN) & Logic "0" ( $\overline{LIN}$ ) input voltage	2.5	—	—	V	$V_{CC}=10\text{V to }20\text{V}$
$V_{IL}$	Logic "0" (HIN) & Logic "1" ( $\overline{LIN}$ ) input voltage	—	—	0.8		
$I_{IN+}$	Logic "1" Input bias current	—	3	10	$\mu\text{A}$	$HIN = 5\text{V}$ , $\overline{LIN} = 0\text{V}$
$I_{IN-}$	Logic "0" Input bias current	—	—	5		$HIN = 0\text{V}$ , $\overline{LIN} = 5\text{V}$

### Dynamic Electrical Characteristics

$V_{CC} = V_B = 15\text{V}$ ,  $V_S = COM$ ,  $T_A = 25^\circ\text{C}$ , and  $C_L = 1000\text{pF}$  unless otherwise specified.

Symbol	Definition	Min.	Typ.	Max.	Units	Test Conditions
$t_{ON}$	Turn-on propagation delay	—	160	220	ns	$V_S = 0\text{V or }200\text{V}$
$t_{OFF}$	Turn-off propagation delay	—	150	220		
$t_R$	Turn-on rise time	—	70	170		$V_S = 0\text{V}$
$t_F$	Turn-off fall time	—	30	90		
MT	Delay matching time ( $t_{ON}$ , $t_{OFF}$ )	—	—	50		
DT	Deadtime, LS turn-off to HS turn-on & HS turn-on to LS turn-off	400	520	650		
MDT	Deadtime matching time ( $DT_{LO/HO} - DT_{HO/LO}$ )	—	—	30		

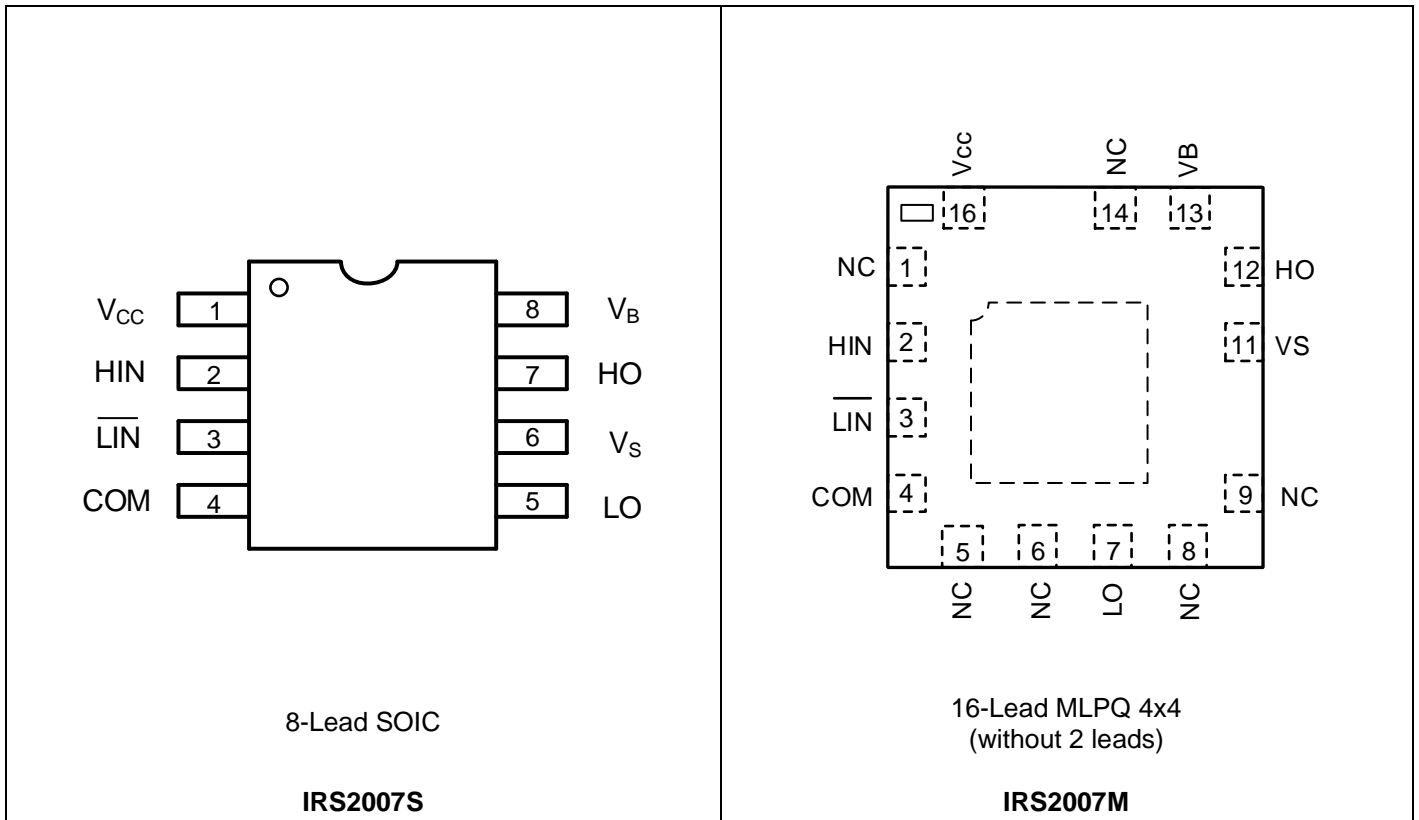
**Functional Block Diagram**



**Lead Definitions**

Symbol	Description
V <sub>CC</sub>	Low-side and logic supply voltage
V <sub>B</sub>	High-side gate drive floating supply
V <sub>S</sub>	High voltage floating supply return
HIN	Logic inputs for high-side gate driver output (HO), in phase
$\overline{\text{LIN}}$	Logic inputs for low-side gate driver output (LO), out of phase
HO	High-side driver output
LO	Low-side driver output
COM	Low-side gate drive return

### Lead Assignments



### Application Information and Additional Details

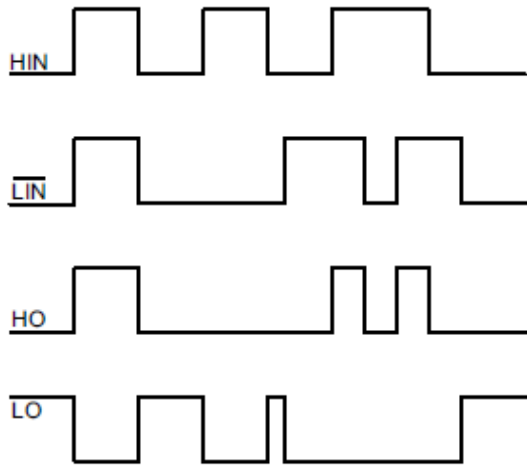


Figure 1. Input/Output Timing Diagram

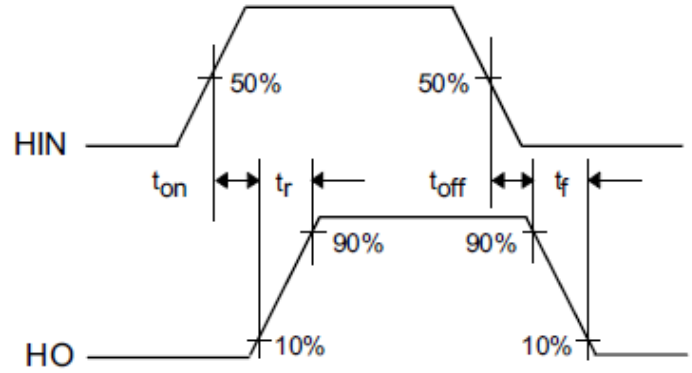
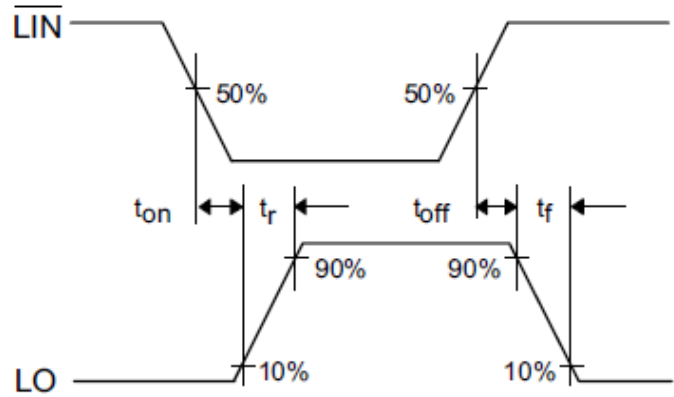


Figure 2. Switching Time Waveform Definitions

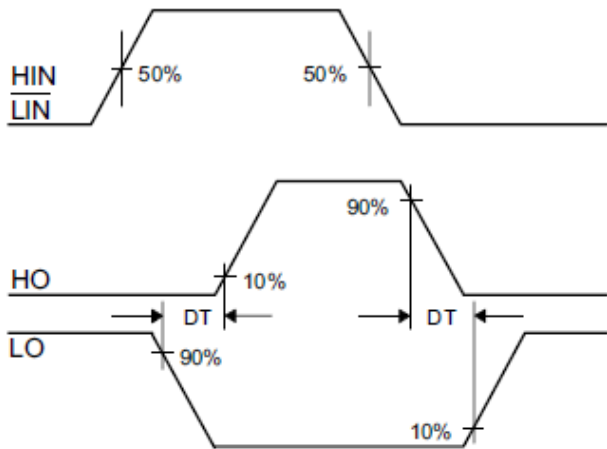
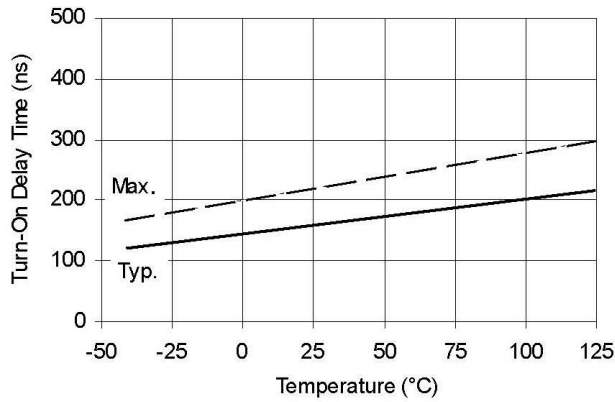
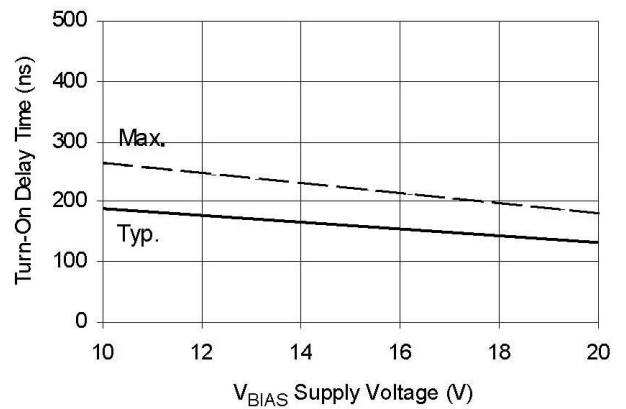


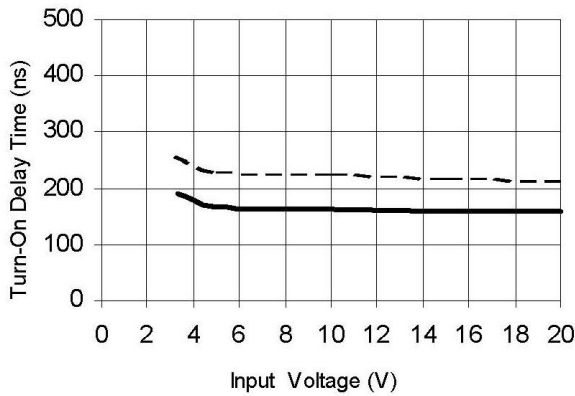
Figure 3. Deadtime Waveform Definitions



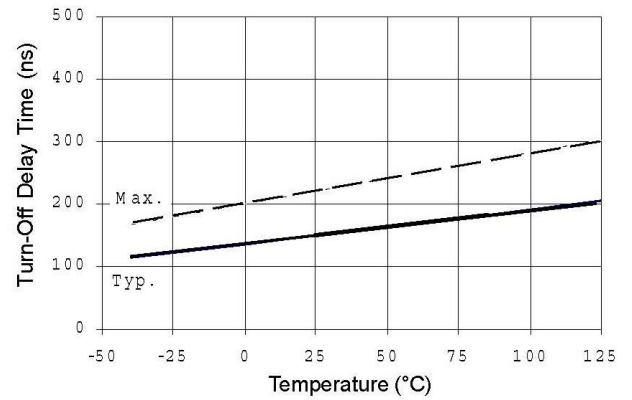
**Figure 4A. Turn-On Time vs. Temperature**



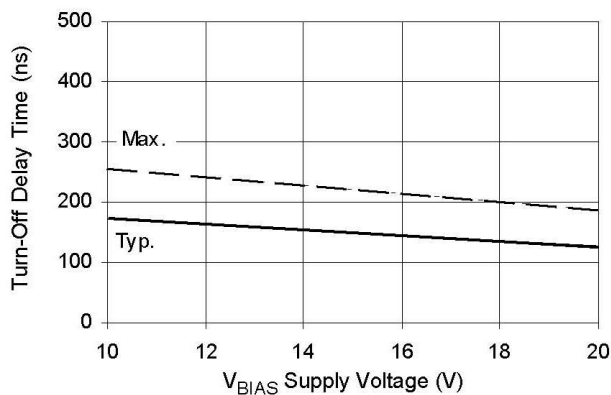
**Figure 4B. Turn-On Time vs. Supply Voltage**



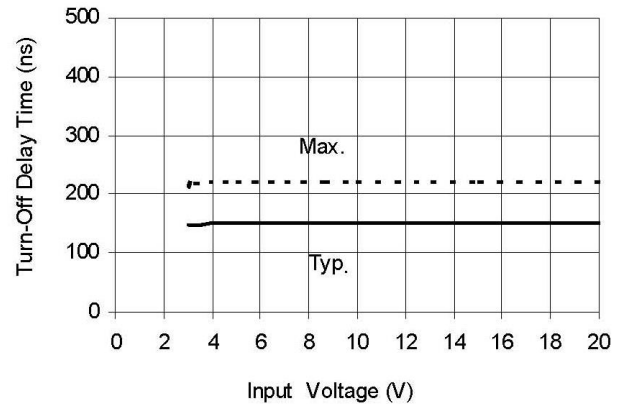
**Figure 4C. Turn-On Time vs. Input Voltage**



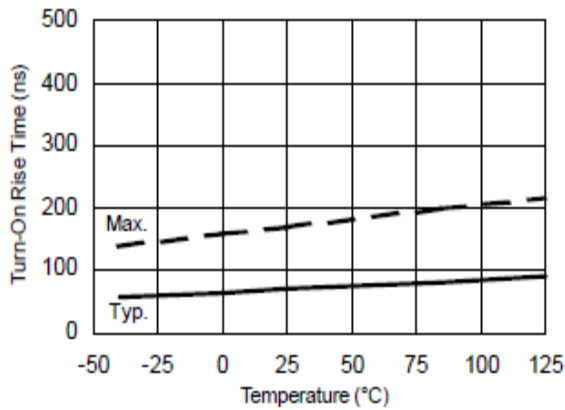
**Figure 5A. Turn-Off Time vs. Temperature**



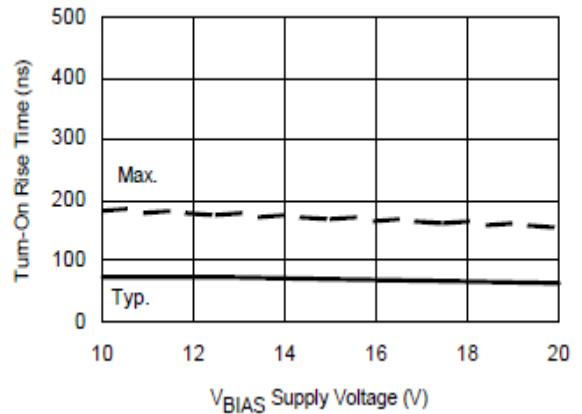
**Figure 5B. Turn-Off Time vs. Supply Voltage**



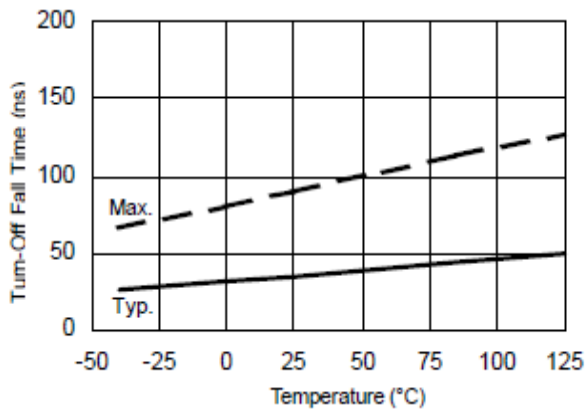
**Figure 5C. Turn-Off Time vs. Input Voltage**



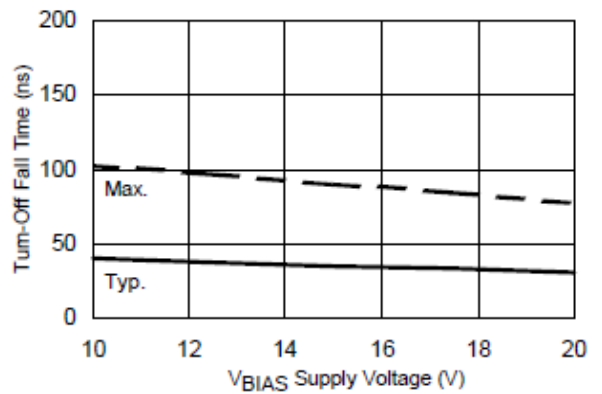
**Figure 6A. Turn-On Rise Time vs. Temperature**



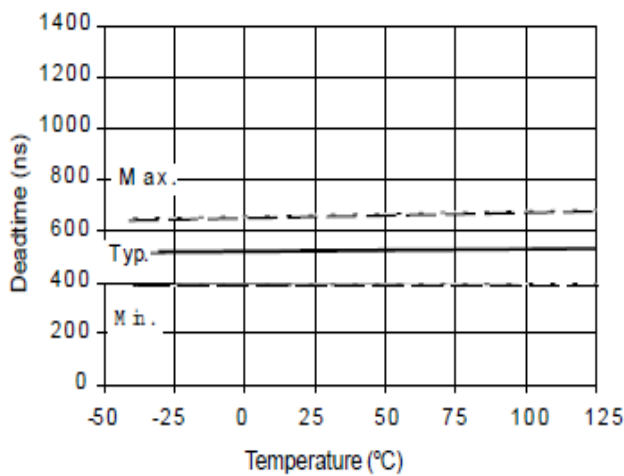
**Figure 6B. Turn-On Rise Time vs. Voltage**



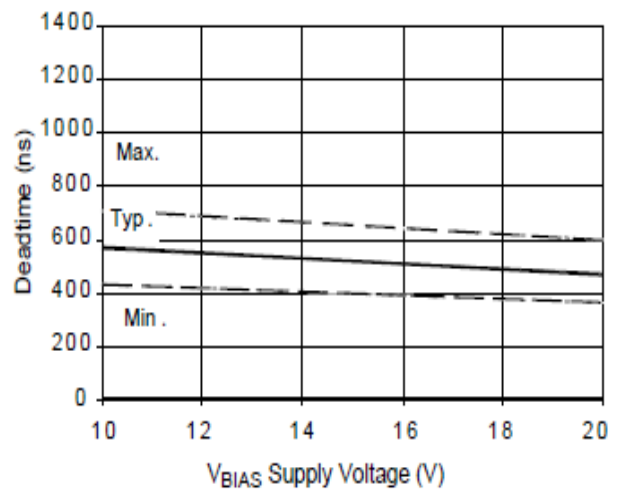
**Figure 7A. Turn-Off Fall Time vs. Temperature**



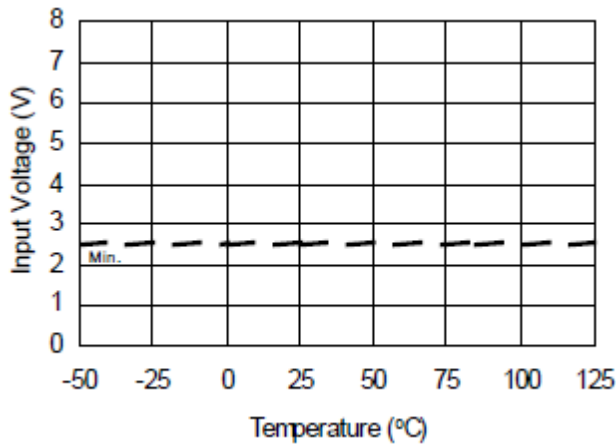
**Figure 7B. Turn-Off Fall Time vs. Voltage**



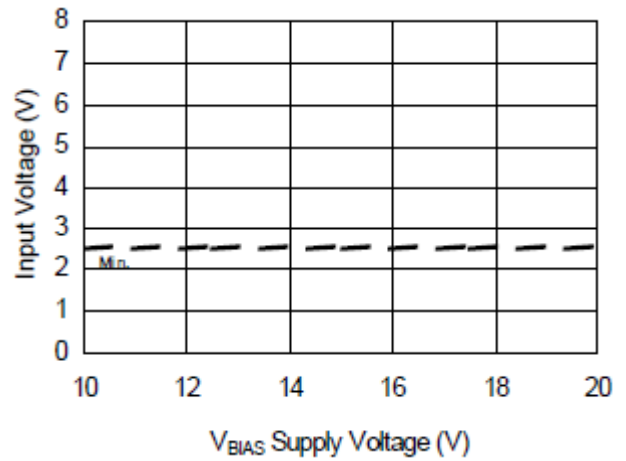
**Figure 8A. Deadtime vs. Temperature**



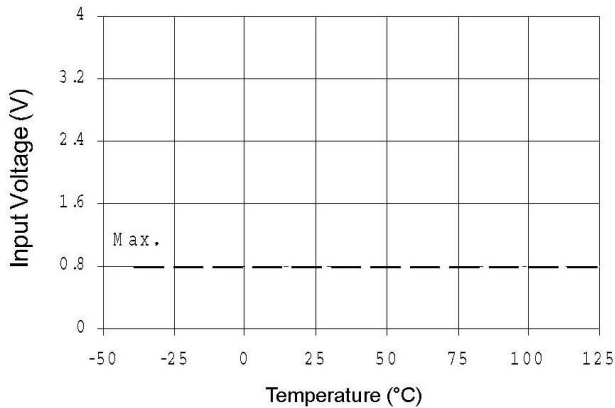
**Figure 8B. Deadtime vs. Voltage**



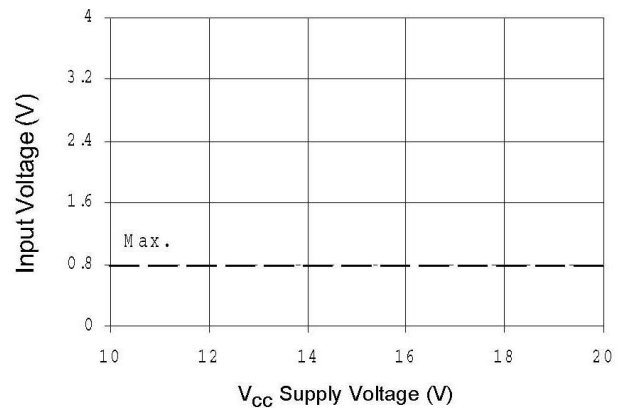
**Figure 9A. Logic "1"(HIN) & Logic "0"(LIN) Input Voltage vs. Temperature**



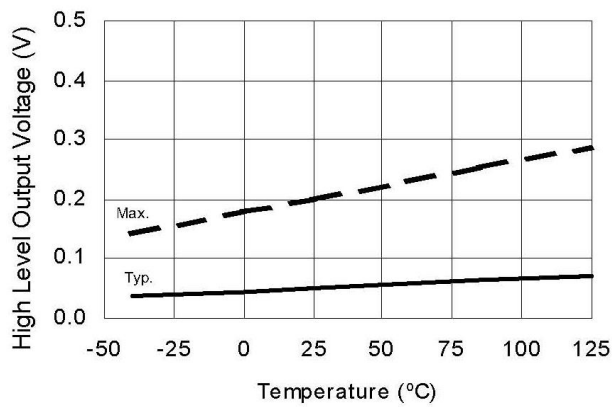
**Figure 9B. Logic "1"(HIN) & Logic "0"(LIN) Input Voltage vs. Voltage**



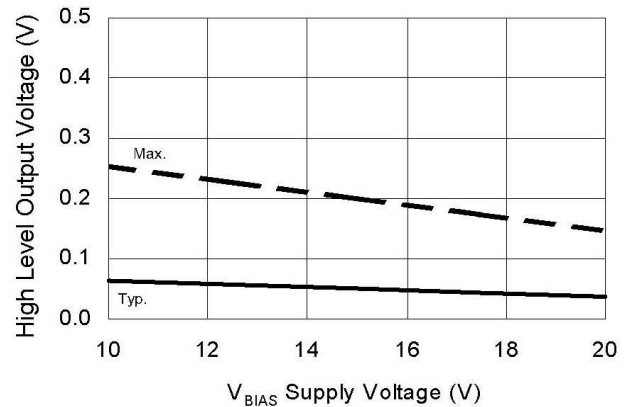
**Figure 10A. Logic "0"(HIN) & Logic "1"(LIN) Input Voltage vs. Temperature**



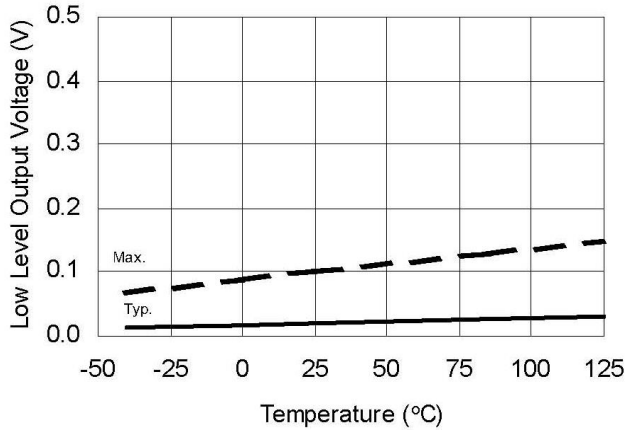
**Figure 10B. Logic "0"(HIN) & Logic "1"(LIN) Input Voltage vs. Voltage**



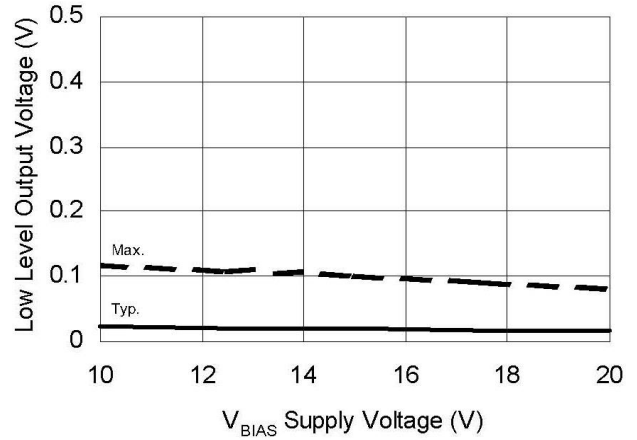
**Figure 11A. High Level Output Voltage vs. Temperature**



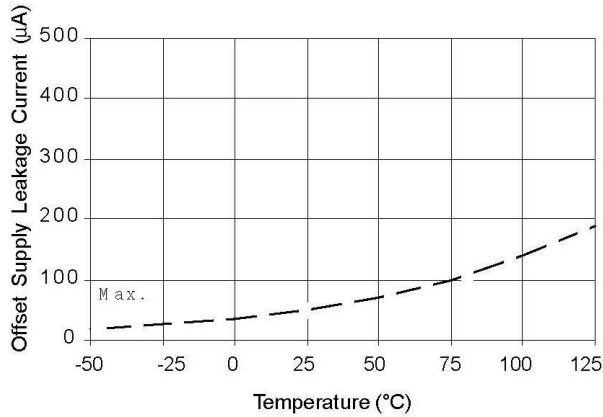
**Figure 11B. High Level Output Voltage vs. Supply Voltage**



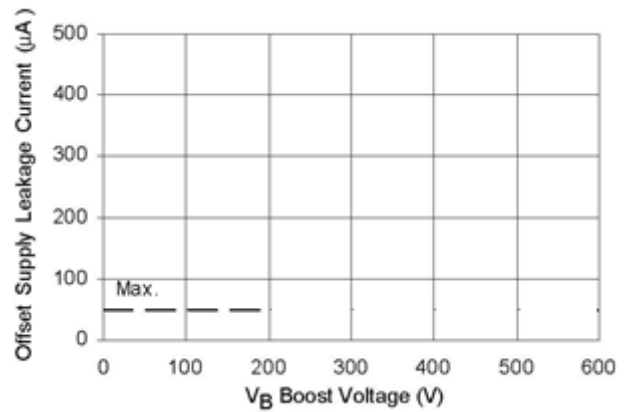
**Figure 12A. Low Level Output Voltage vs. Temperature**



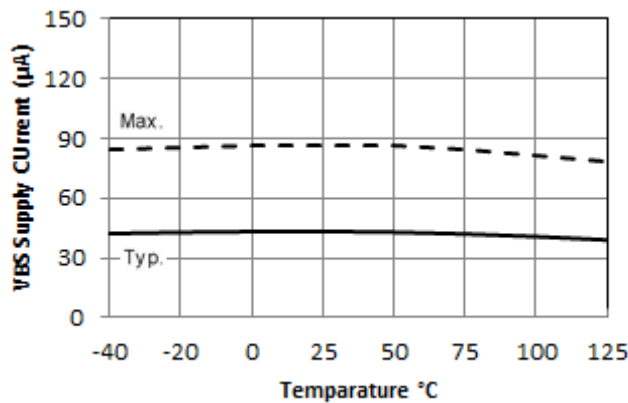
**Figure 12B. Low Level Output Voltage vs. Supply Voltage**



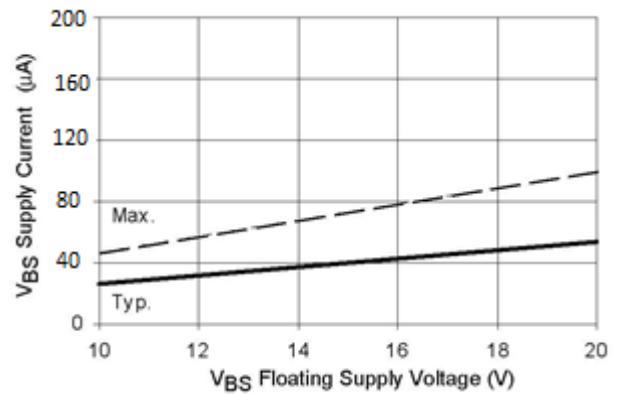
**Figure 13A. Offset Supply Current vs. Temperature**



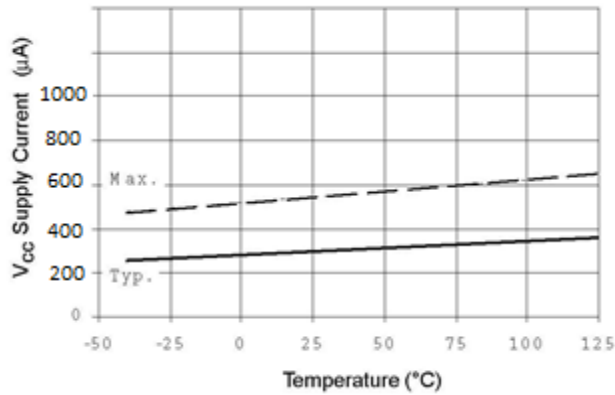
**Figure 13B. Offset Supply Current vs. Voltage**



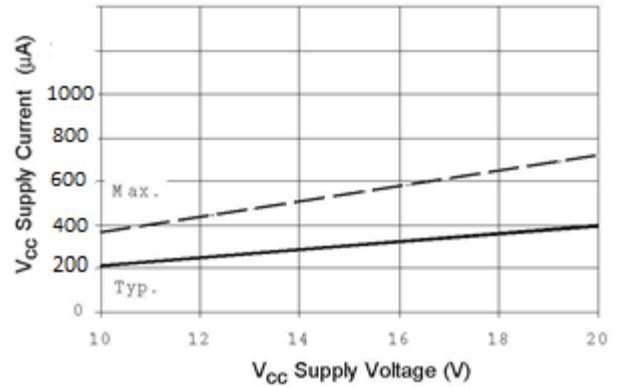
**Figure 14A. V<sub>BS</sub> Supply Current vs. Temperature**



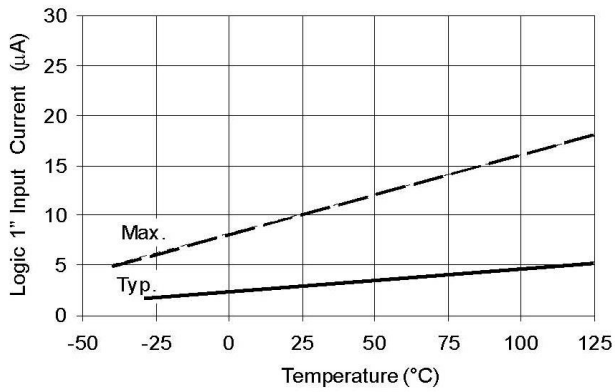
**Figure 14B. V<sub>BS</sub> Supply Current vs. Voltage**



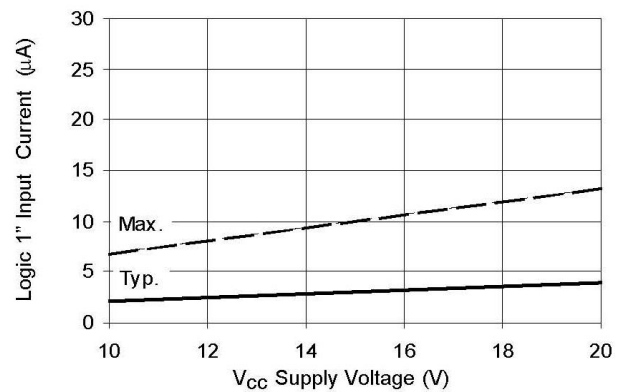
**Figure 15A.  $V_{CC}$  Supply Current vs. Temperature**



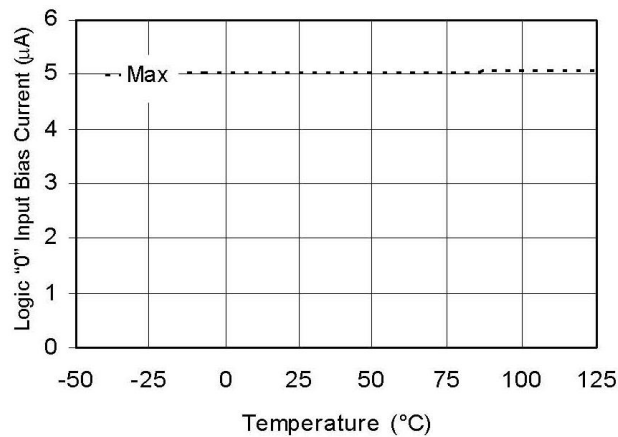
**Figure 15B.  $V_{CC}$  Supply Current vs. Voltage**



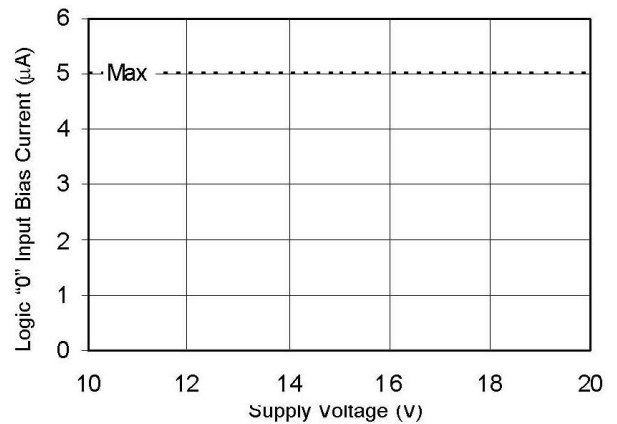
**Figure 16A. Logic "1" Input Current vs. Temperature**



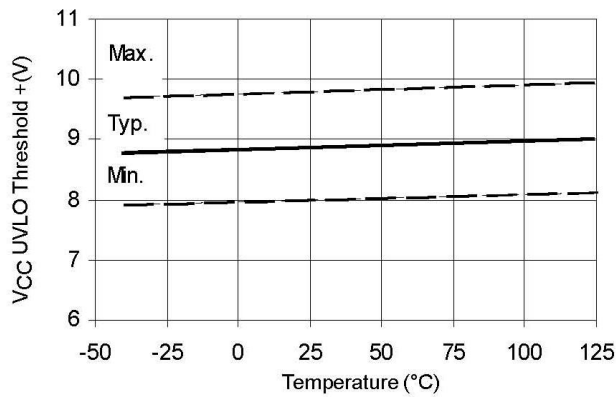
**Figure 16B. Logic "1" Input Current vs. Voltage**



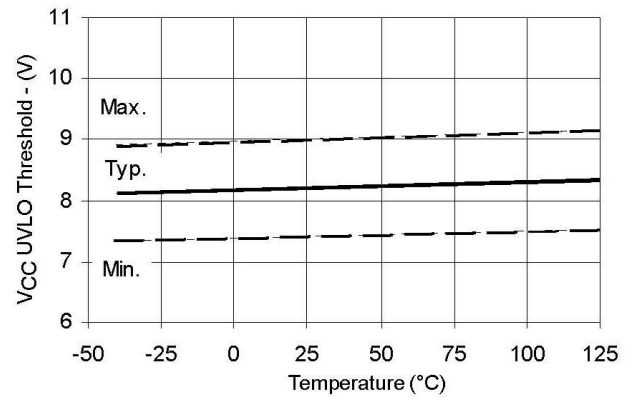
**Figure 17A. Logic "0" Input Bias Current**



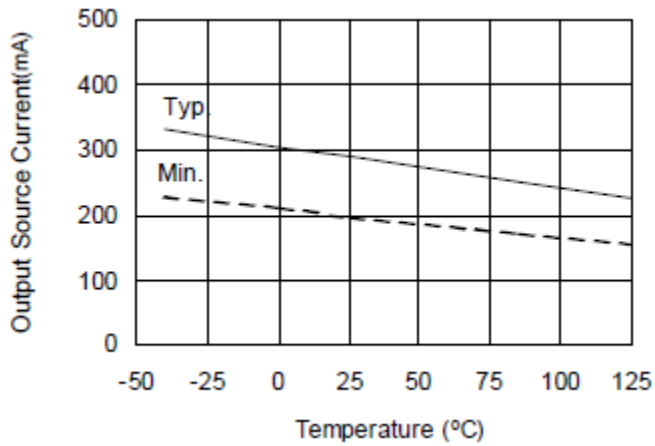
**Figure 17B. Logic "0" Input Bias Current**



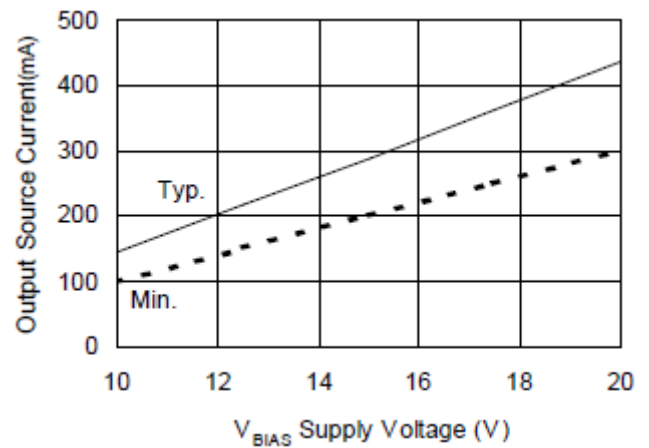
**Figure 18A.  $V_{CC} \setminus V_{BS}$  Undervoltage Threshold(+) vs. Temperature**



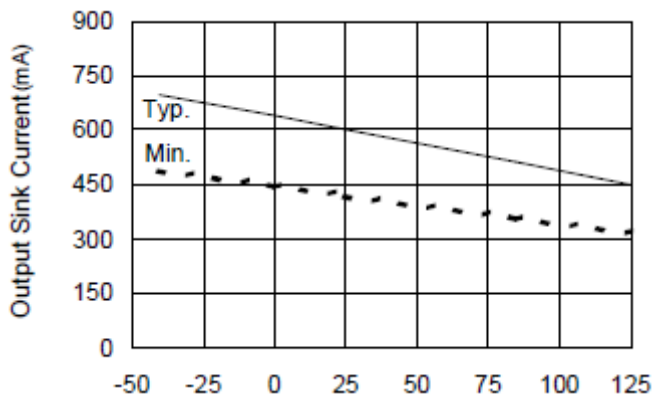
**Figure 18B.  $V_{CC} \setminus V_{BS}$  Undervoltage Threshold(-) vs. Temperature**



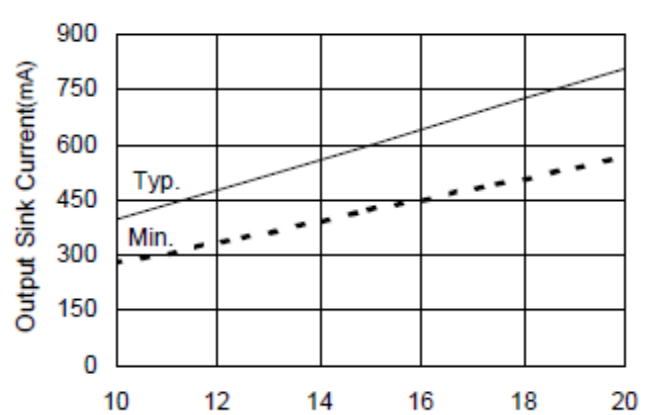
**Figure 19A. Output Source Current vs. Temperature**



**Figure 19B. Output Source Current vs. Supply Current**

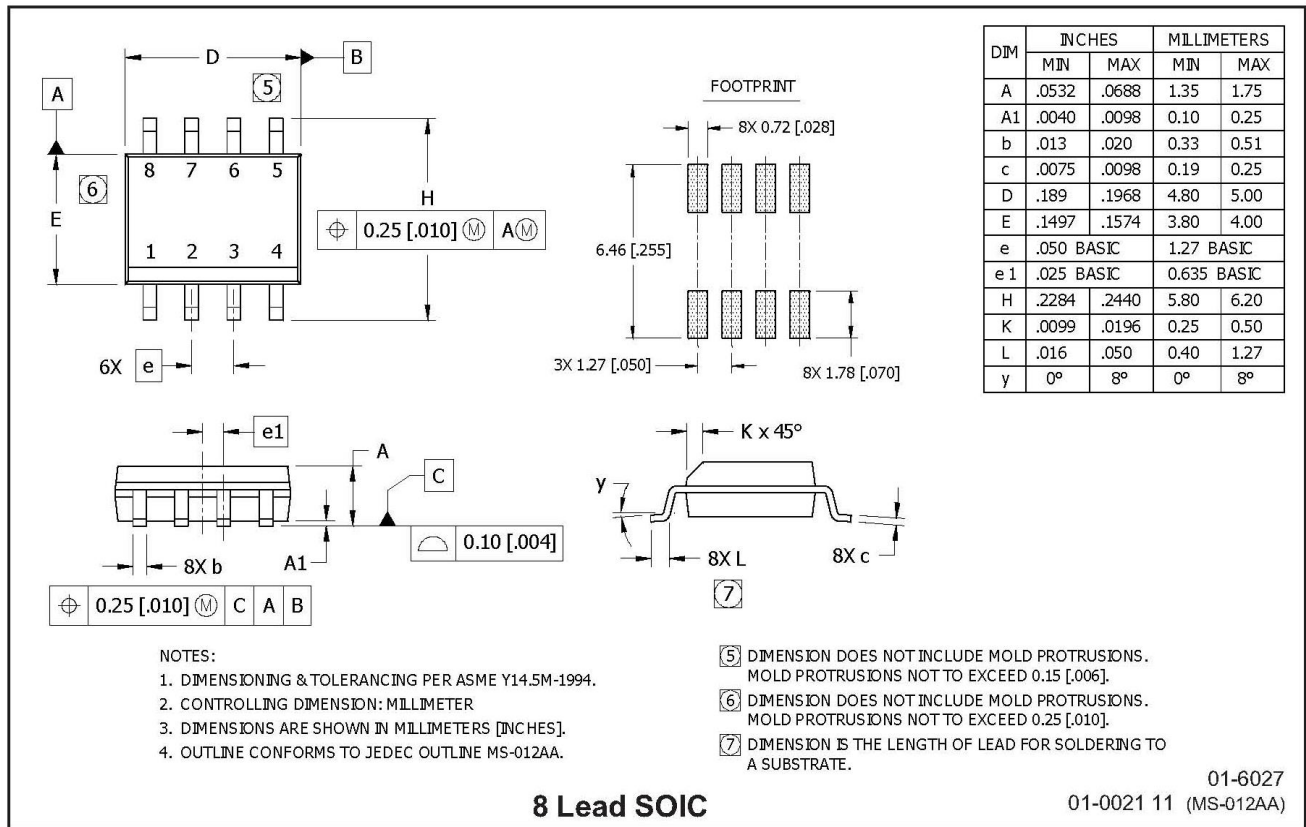


**Figure 20A. Output Sink Current vs. Temperature**

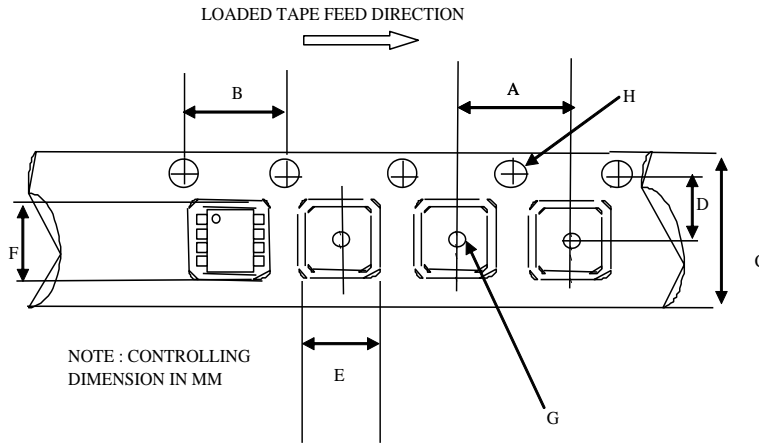


**Figure 20B. Output Sink Current vs. Supply Voltage**

**Package Details: 8-Lead SOIC**

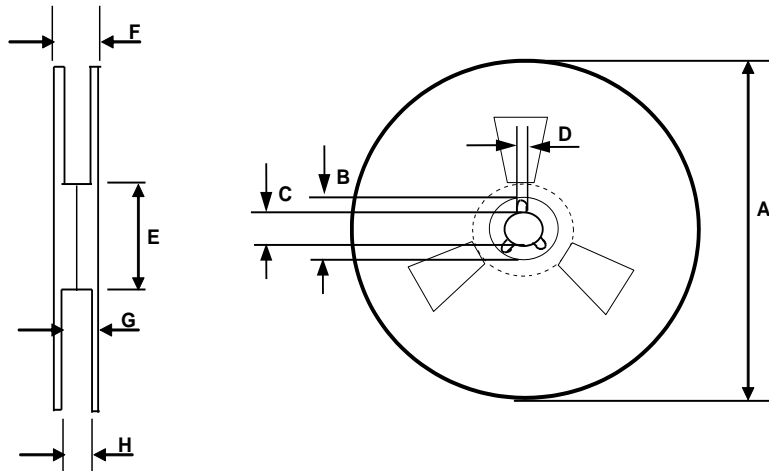


**Tape and Reel Details: 8-Lead SOIC**



CARRIER TAPE DIMENSION FOR 8SOICN

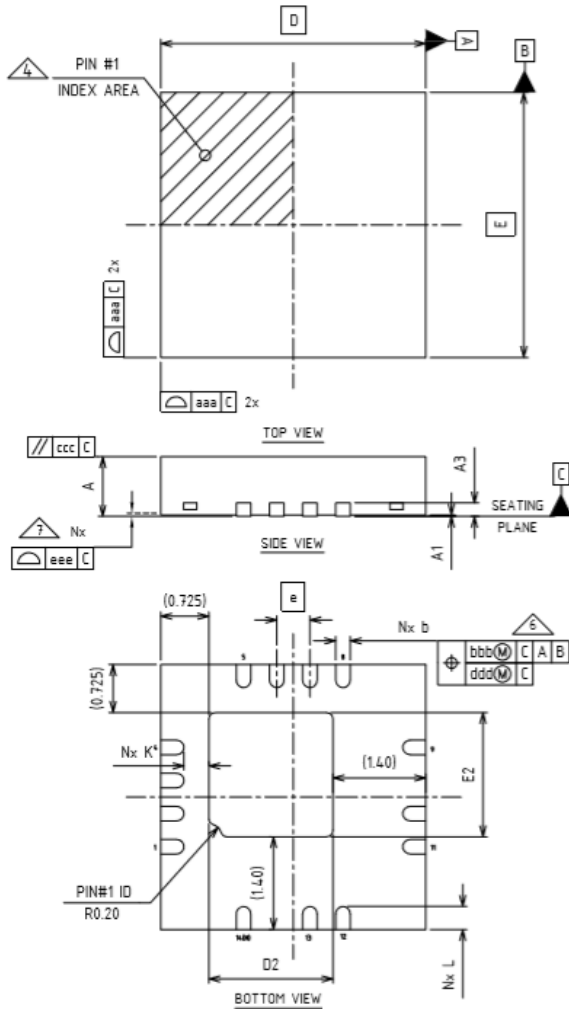
Code	Metric		Imperial	
	Min	Max	Min	Max
A	7.90	8.10	0.311	0.318
B	3.90	4.10	0.153	0.161
C	11.70	12.30	0.46	0.484
D	5.45	5.55	0.214	0.218
E	6.30	6.50	0.248	0.255
F	5.10	5.30	0.200	0.208
G	1.50	n/a	0.059	n/a
H	1.50	1.60	0.059	0.062



REEL DIMENSIONS FOR 8SOICN

Code	Metric		Imperial	
	Min	Max	Min	Max
A	329.60	330.25	12.976	13.001
B	20.95	21.45	0.824	0.844
C	12.80	13.20	0.503	0.519
D	1.95	2.45	0.767	0.096
E	98.00	102.00	3.858	4.015
F	n/a	18.40	n/a	0.724
G	14.50	17.10	0.570	0.673
H	12.40	14.40	0.488	0.566

**Package Details: 14-Lead MLPQ 4x4**

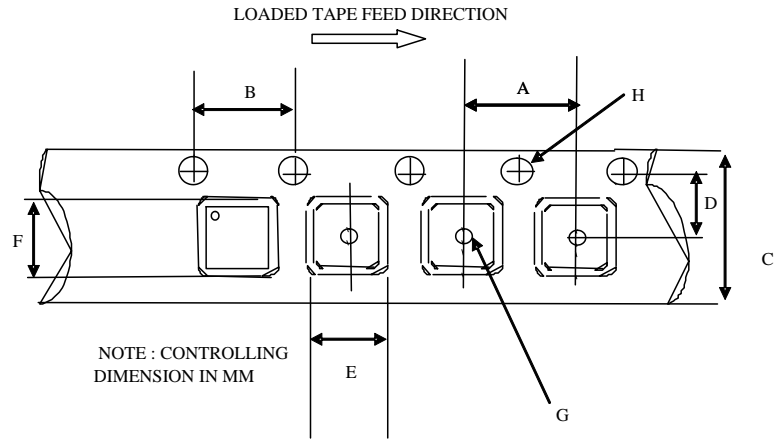


NOTE:

1. Dimensioning and tolerancing conform to ASME Y14.5-2009.
2. All dimensions are in millimeters.
3. N is the total number of terminals.
4. The location of the marked terminal #1 identifier is within the hatched area.
5. ND and NE refer to the number of terminals on each D and E side respectively.
6. Dimension b applies to the metalized terminal and is measured between 0.15mm and 0.30mm from the terminal tip. If the terminal has a radius on the other end of it, dimension b should not be measured in that radius area.
7. Coplanarity applies to the terminals and all other bottom surface metalization.

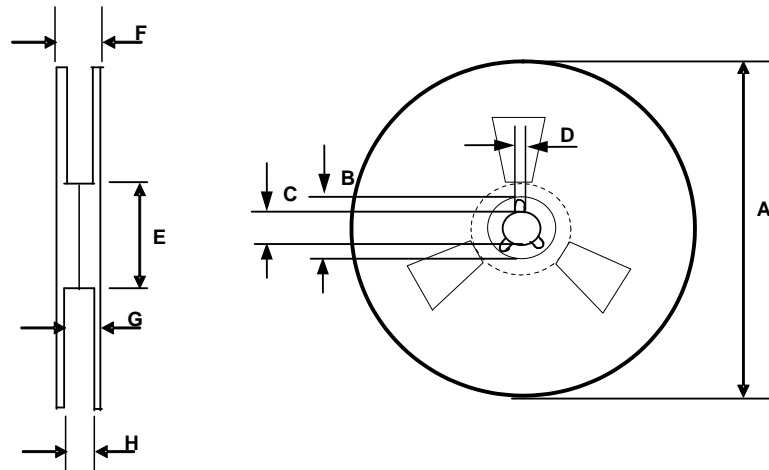
Dimension Table				
Thickness Symbol	V			NOTE
	MINIMUM	NOMINAL	MAXIMUM	
A	0.80	0.90	1.00	
A1	0.00	0.02	0.05	
A3	---	0.20 Ref	---	
b	0.18	0.25	0.30	6
D	4.00 BSC			
E	4.00 BSC			
e	0.50 BSC			
D2	1.725	1.875	1.975	
E2	1.725	1.875	1.975	
K	0.20	---	---	
L	0.25	0.35	0.45	
aaa	0.05			
bbb	0.10			
ccc	0.10			
ddd	0.05			
eee	0.08			
N	14			3
ND	SEE FIGURE			5
NE	SEE FIGURE			
NOTES	1, 2			

**Tape and Reel Details: 14-Lead MLPQ 4x4**



CARRIER TAPE DIMENSION FOR MLPQ4x4

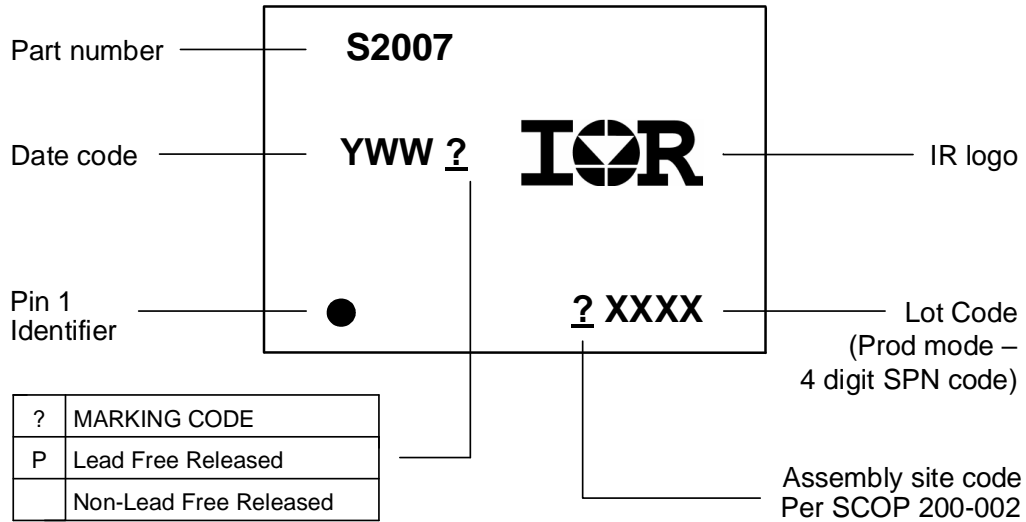
Code	Metric		Imperial	
	Min	Max	Min	Max
A	7.90	8.10	0.311	0.358
B	3.90	4.10	0.153	0.161
C	11.70	12.30	0.461	0.484
D	5.45	5.55	0.215	0.219
E	4.25	4.45	0.168	0.176
F	4.25	4.45	0.168	0.176
G	1.50	n/a	0.069	n/a
H	1.50	1.60	0.069	0.063



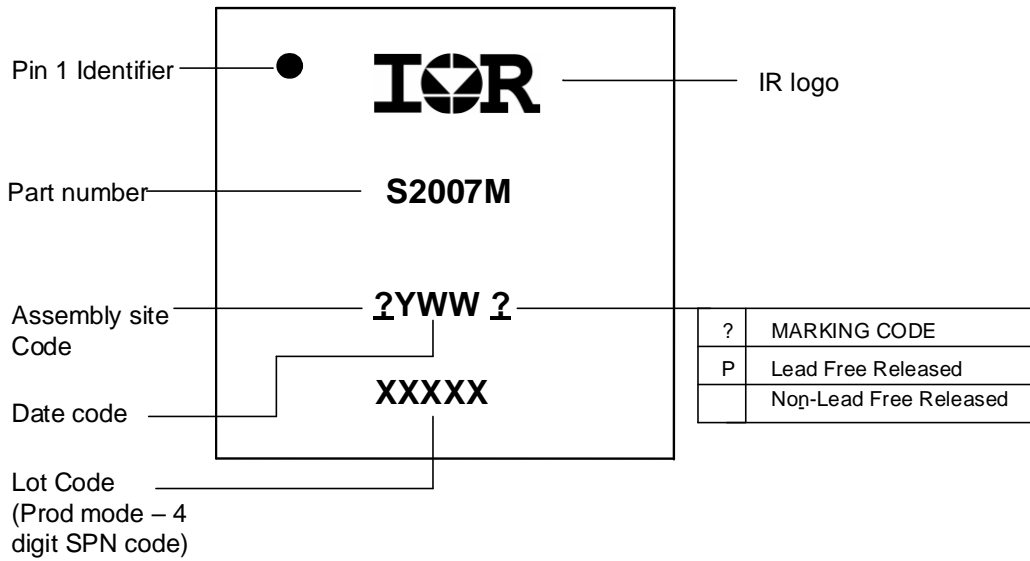
REEL DIMENSIONS FOR MLPQ4x4

Code	Metric		Imperial	
	Min	Max	Min	Max
A	329.60	330.25	12.976	13.001
B	20.95	21.45	0.824	0.844
C	12.80	13.20	0.503	0.519
D	1.95	2.45	0.767	0.096
E	98.00	102.00	3.858	4.015
F	n/a	18.40	n/a	0.724
G	14.50	17.10	0.570	0.673
H	12.40	14.40	0.488	0.566

**Part Marking Information**



**8-Lead SOIC8  
 IRS2007SPBF**



**14-Lead MLPQ 4x4  
 IRS2007MPBF**

**Qualification Information<sup>†</sup>**

<b>Qualification Level</b>		Industrial <sup>†</sup>	
		Comments: This family of ICs is qualified according to relevant tests of JEDEC47/22/20. IR's Consumer qualification level is granted by extension of the higher Industrial level.	
<b>Moisture Sensitivity Level</b>		8 Lead SOIC	MSL2 <sup>††</sup> , 260°C (per IPC/JEDEC J-STD-020)
		14-Lead MLPQ 4x4	
<b>ESD</b>	Human Body Model	Class 2 (per JEDEC standard JESD22-A114)	
	Machine Model	Class A (per EIA/JEDEC standard EIA/JESD22-A115)	
<b>IC Latch-Up Test</b>		Class I (per JESD78)	
<b>RoHS Compliant</b>		Yes	

† According to IR Qualification Requirements for IC products.

†† Higher MSL ratings may be available for the specific package types listed here. Please contact your Infineon sales representative for further information.

**Published by**  
**Infineon Technologies AG**  
**81726 München, Germany**  
**© Infineon Technologies AG 2020**  
**All Rights Reserved.**

### **IMPORTANT NOTICE**

The information given in this document shall in no event be regarded as a guarantee of conditions or characteristics ("Beschaffenheitsgarantie"). With respect to any examples, hints or any typical values stated herein and/or any information regarding the application of the product, Infineon Technologies hereby disclaims any and all warranties and liabilities of any kind, including without limitation warranties of non-infringement of intellectual property rights of any third party.

In addition, any information given in this document is subject to customer's compliance with its obligations stated in this document and any applicable legal requirements, norms and standards concerning customer's products and any use of the product of Infineon Technologies in customer's applications.

The data contained in this document is exclusively intended for technically trained staff. It is the responsibility of customer's technical departments to evaluate the suitability of the product for the intended application and the completeness of the product information given in this document with respect to such application.

For further information on the product, technology, delivery terms and conditions and prices please contact your nearest Infineon Technologies office ([www.infineon.com](http://www.infineon.com)).

### **WARNINGS**

Due to technical requirements products may contain dangerous substances. For information on the types in question please contact your nearest Infineon Technologies office.

Except as otherwise explicitly approved by Infineon Technologies in a written document signed by authorized representatives of Infineon Technologies, Infineon Technologies' products may not be used in any applications where a failure of the product or any consequences of the use thereof can reasonably be expected to result in personal injury.

## Looking for pricing, stock, or lifecycle information?

Click below to explore more details on WIN SOURCE:

 [View IRS2007SPBF](#) on WIN SOURCE

 [Infineon Technologies](#) Information

## Optimize Your Supply Chain with WIN SOURCE Solutions

-  Global Sourcing Solution
-  Obsolete Management
-  Cost Control Management
-  Shortage Management
-  Alternative Solution
-  Excess Inventory Management