



**THE DATASHEET OF
445C25D30M00000**



FEATURES

- Standard 5.0mm x 3.2mm Glass Seal Package
- Fundamental Crystal Design
- Frequency Range 8 – 50MHz
- Frequency Tolerance, $\pm 20\text{ppm}$ Standard [other tolerances available]
- Frequency Stability, $\pm 30\text{ppm}$ Standard [other stabilities available]
- Operating Temperature to -40°C to $+85^{\circ}\text{C}$
- Tape & Reel Packaging Standard, EIA-481
- **RoHS Compliant in Accordance with EU Directive 2011/65/EU**
 - Lead-Free Termination Finish
 - Exemption 7(c)-1, Electrical and electronic components containing lead [Pb] in glass



APPLICATIONS

Model 445 is a low cost device used in a wide range of commercial applications including notebooks, computer peripherals, audio visual, Bluetooth and USB interfaces, PDAs, and automotive electronics.

ORDERING INFORMATION

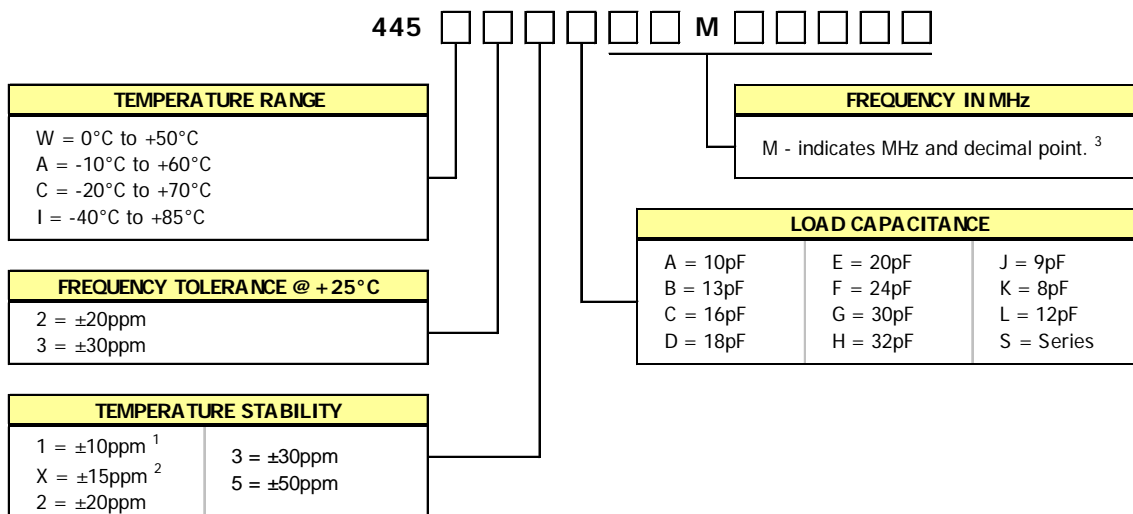

1. Only available with temperature range codes "W" and "A".
2. Only available with temperature range codes "W", "A" and "C".
3. Frequency is recorded with two leading digits before the 'M' and 5 significant digits after the 'M' [including zeros].

Not all performance combinations and frequencies may be available.
Contact your local CTS Representative or CTS Customer Service for availability.

PACKAGING INFORMATION [For Reference]

Factory may package reels in quantities of 1k pcs. or 3k pcs. Reel size is 180mm.



ELECTRICAL CHARACTERISTICS

PARAMETER		VALUE		
ELECTRICAL PARAMETERS	Frequency Range	8MHz to 50MHz		
	Operating Mode	Fundamental		
	Crystal Cut	AT-Cut		
	Frequency Tolerance @ +25°C	±20ppm, ±30ppm		
	Frequency Stability Tolerance [Operating Temperature Range, Referenced to 25°C Reading]	±10ppm, ±15ppm, ±20ppm, ±30ppm, ±50ppm		
	Operating Temperature Ranges	0°C to +50°C	-10°C to +60°C	
		-20°C to +70°C	-40°C to +85°C	
	Equivalent Series Resistance [Maximum]	8MHz - <12MHz	100 Ohms	
		12MHz - <16MHz	50 Ohms	
		16MHz - <30MHz	40 Ohms	
		30MHz - <50MHz	30 Ohms	
	Load Capacitance or Resonance Mode	See Ordering Information		
Shunt Capacitance [C ₀]	5.0pF Typical, 7.0pF Maximum			
Drive Level	10µW Min., 100µW Typ., 300µW Max.			
Aging @ +25°C	±3ppm/yr Typical			
Storage Temperature Range	-40°C to +85°C			

MECHANICAL SPECIFICATIONS

PACKAGE DRAWING



MARKING INFORMATION

1. M445 - CTS Model Series.
2. C - CTS.
3. D - Date code. See Table I for codes.
4. XXX - Frequency code.
Reference CTS document 016-1454-0.

NOTES

1. Complete CTS part number, frequency value, date code and manufacturing site code information must appear on reel and carton labels.
2. JEDEC termination code (e4). Barrier plating is nickel [Ni] with gold [Au] flash plate.
3. Reflow conditions per JEDEC J-STD-020; 260°C maximum, 10 seconds.
4. MSL - 1.

SUGGESTED SOLDER PAD GEOMETRY

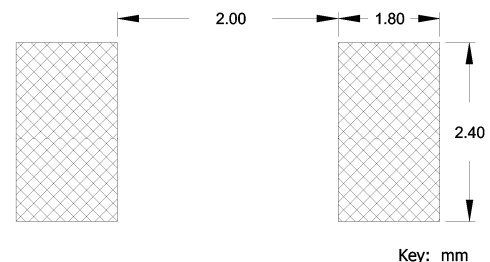

TABLE I - DATE CODE

YEAR		MONTH				JAN	FEB	MAR	APR	MAY	JUN	JUL	AUG	SEP	OCT	NOV	DEC
2001	2005	2009	2013	2017	A	B	C	D	E	F	G	H	J	K	L	M	
2002	2006	2010	2014	2018	N	P	Q	R	S	T	U	V	W	X	Y	Z	
2003	2007	2011	2015	2019	a	b	c	d	e	f	g	h	j	k	l	m	
2004	2008	2012	2016	2020	n	p	q	r	s	t	u	v	w	x	y	z	

Looking for pricing, stock, or lifecycle information?

Click below to explore more details on WIN SOURCE:

- ⊖ [View 445C25D30M00000 on WIN SOURCE](#)
- ⊖ [CTS-Frequency Controls Information](#)

Optimize Your Supply Chain with WIN SOURCE Solutions

- ✓ Global Sourcing Solution
- ✓ Obsolete Management
- ✓ Cost Control Management
- ✓ Shortage Management
- ✓ Alternative Solution
- ✓ Excess Inventory Management