



THE DATASHEET OF
345-016-521-201



345/395 SERIES



Card Edge Connectors 0.100" (2.54mm) Pitch

Features:

- 0.100" (2.54mm) contact spacing x 0.200" (5.08mm) row spacing
- Accepts 0.062" (1.57mm) nominal thickness P.C. board
- High profile insulator body, 0.600" (15.24mm)
- Contact termination options include P.C. tail, wire wrap, 90 degree bends and extender board bends
- Single or dual row configurations
- Large variety of mounting options, flush or offset lugs
- Accepts between contact and in-contact polarizing keys
- Pre-assembled card guides are available
- Automatic wire wrap positioning holes
- RoHS Compliant & UL Certified

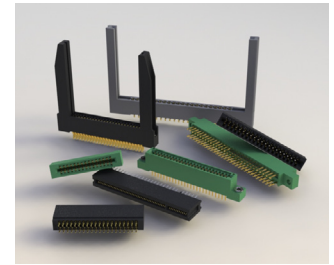

Specifications:

Insulator Material	UL 94V-0 Thermoplastic Polyester
Contact Material	Copper Alloy
Contact Plating	Gold Plating on mating area and Tin Plating on tails with Nickel underplating all over
Current Rating	3 amps
Contact Resistance	10 milliohms maximum
Dielectric Withstanding Voltage	1200 V AC rms at sea level between adjacent contacts
Insulation Resistance	5000 megaohms minimum
Operating Temperature	-40°C to +105°C
Insertion Force	16 oz (4.45 N) maximum per contact pair when tested with .070" (1.78mm) thick gauge
Withdrawal Force	1 oz (0.28 N) minimum per contact pair when tested with .054" (1.37mm) thick gauge

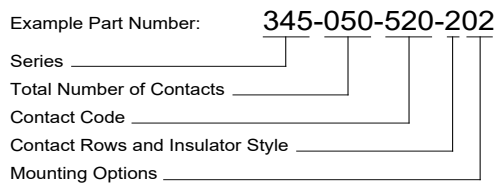

Series:	Insulator Color:	
345	Thermoplastic Polyester, Green	
395	Thermoplastic Polyester, Black	
Total Number of Contacts:	Contact Rows:	
005, 006, . . . 072	Single Row	
010, 012, . . . 144	Dual Row	
Insulator Style:	Description:	Insulator Style
1	Single Row	Flush Mounting Lugs
2	Dual Row	Flush Mounting Lugs
4	Single Row	.110 (2.79) Offset Lugs
5	Dual Row	.110 (2.79) Offset Lugs
6	Single Row	.170 (4.32) Offset Lugs
8	Dual Row	.170 (4.32) Offset Lugs

- Ordering Code Notes:**
- 1) All connector sizes up to 72 contacts single row / 144 contacts dual row are available upon request.
 - 2) The 500 contact code is only available in the 345 series. Green Diallyl Phthalate insulator material will be supplied.
 - 3) For details of the extender board and 90 degree bends refer to next pages.
 - 4) For lug-less connectors, code 01 mounting, specify contact row code 1 or 2.
 - 5) For details of the mounting options refer to page 3 & page 4.

Contact Code:	Tail Description:	Tail Size:	Tail Length "G":
500	Wire Hole	.050 x .025 (1.27 x 0.64)	.260 (6.60)
520	P.C. Tail	.030 x .018 (0.76 x 0.46)	.175 (4.45)
521	P.C. Tail	.025 Square (0.64 Square)	.150 (3.81)
523	P.C. Tail	.025 Square (0.64 Square)	.390 (9.91)
524	P.C. Tail	.018 Square (0.46 Square)	.175 (4.45)
525	P.C. Tail	.018 Square (0.46 Square)	.150 (3.81)
540	Wire Wrap	.025 Square (0.64 Square)	.560 (14.22)
541	Wire Wrap	.025 Square (0.64 Square)	.750 (19.05)
542	Wire Wrap	.025 Square (0.64 Square)	.645 (16.38)
544	Wire Wrap	.050 x .025 (1.27 x 0.64)	.750 (19.05)
555	EXTENDER BOARD BEND	(CODE 500 CONTACTS)	
556	EXTENDER BOARD BEND	(CODE 520 CONTACTS)	
558	90 DEGREE BEND	(CODE 541 CONTACTS)	
559	90 DEGREE BEND	(CODE 541 CONTACTS)	
560	EXTENDER BOARD BEND	(CODE 523 CONTACTS)	

Mounting Options:	Description:
01	No Mounting Lug
02	Ø.128" (Ø3.25mm) Mounting Holes
03	Ø.116" (Ø2.95mm) I.D. Floating Eyelets
04	Ø.156" (Ø3.96mm) Mounting Holes
07	M3-0.5 Metric Threaded Inserts
08	#4-40 Unified Threaded Inserts
12	Ø.128" (Ø3.25mm) Side Mounting Holes
58	.468" (11.89mm) Offset Card Guides
78	In-Line Card Guides 2.750" (69.85mm) Long
88	In-Line Card Guides 1.250" (31.75mm) Long

Card Edge Connectors 0.100" (2.54mm) Pitch

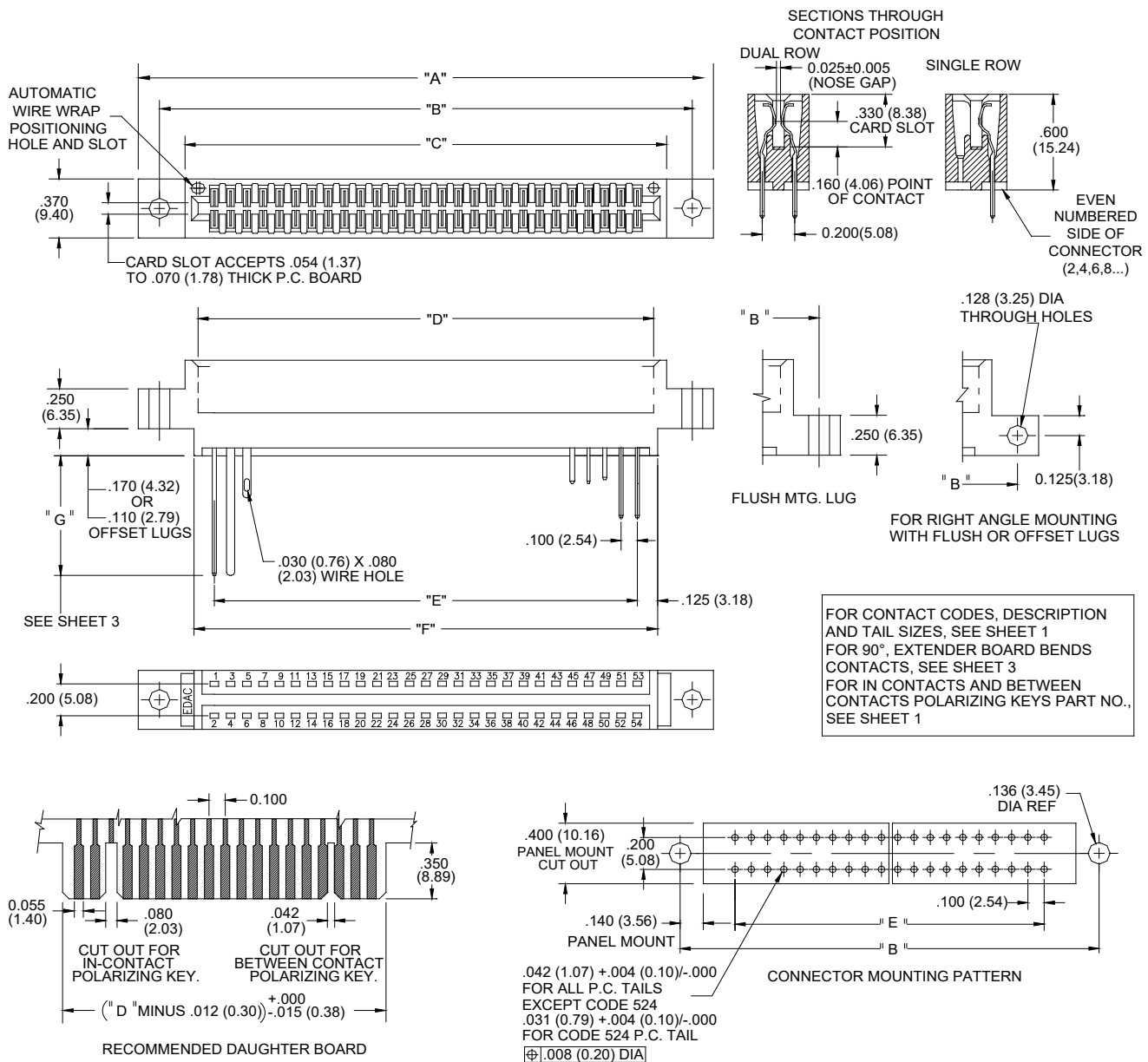

NUMBER OF CONTACTS		"A"±.015 (±0.38)		"B"±.010 (±0.25)		"C"±.015 (±0.38)		"D"±.010 /-.006 (+0.25/-0.15)		"E"±.005 (±0.13)	
Single	Double	Inch	mm	Inch	mm	Inch	mm	Inch	mm	Inch	mm
5	10	1.335	33.91	1.075	27.31	0.760	19.30	0.600	15.24	0.400	10.16
10	20	1.835	46.61	1.575	40.01	1.260	32.00	1.100	27.94	0.900	22.86
13	26	2.135	54.23	1.875	47.63	1.560	39.62	1.400	35.56	1.200	30.48
15	30	2.335	59.31	2.075	52.71	1.760	44.70	1.600	40.64	1.400	35.56
18	36	2.635	66.93	2.375	60.33	2.060	52.32	1.900	48.26	1.700	43.18
22	44	3.035	77.09	2.775	70.49	2.460	62.48	2.300	58.42	2.100	53.34
25	50	3.335	84.71	3.075	78.11	2.760	70.10	2.600	66.04	2.400	60.96
30	60	3.835	97.41	3.575	90.81	3.260	82.80	3.100	78.74	2.900	73.66
31	62	3.935	99.95	3.675	93.35	3.360	85.34	3.200	81.28	3.000	76.20
36	72	4.435	112.65	4.175	106.05	3.860	98.04	3.700	93.98	3.500	88.90
43	86	5.135	130.43	4.875	123.83	4.560	115.82	4.400	111.76	4.200	106.68
50	100	5.835	148.21	5.575	141.61	5.260	133.60	5.100	129.54	4.900	124.46
60	120	6.835	173.61	6.575	167.01	6.260	159.00	6.100	154.94	5.900	149.86
72	144	8.035	204.09	7.775	197.49	7.460	189.48	7.300	185.42	7.100	180.34

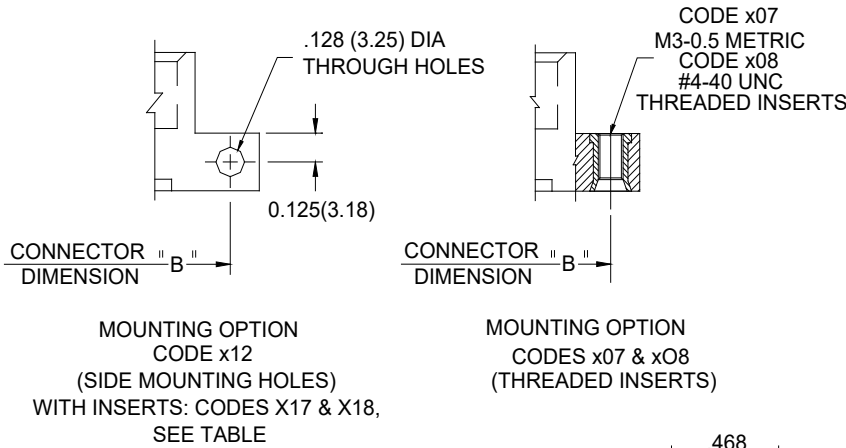
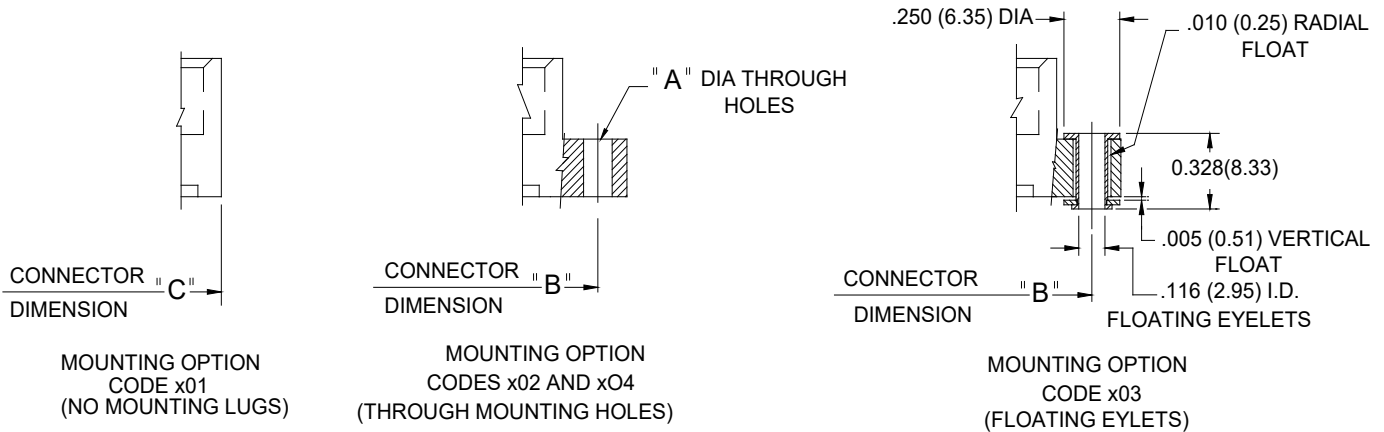

CODE X02 AND X04- THROUGH MTG. HOLES		
	CODE X02	CODE X04
"A" DIA.	0.128(3.25)	0.156(3.96)
CODE X07 AND X08- THREADED INSERTS		
	CODE X07	CODE X08
INSERT	M3-0.5(METRIC)	#4-40 UNC
SIDE MOUNTING HOLES WITH INSERTS		
	CODE X17	CODE X18
INSERT	M3-0.5(METRIC)	#4-40 UNC
CODES X78 AND X88- IN-LINE CARD GUIDES		
	CODE X78	CODE X88
"A"	2.750(69.85)	1.250(31.75)

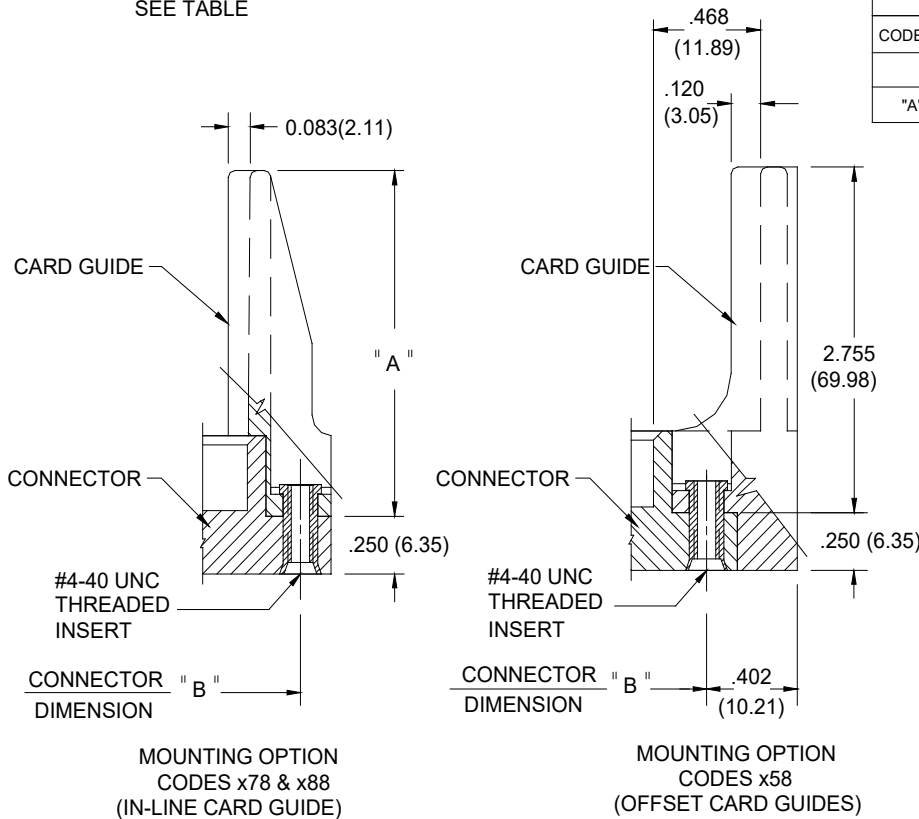

Looking for pricing, stock, or lifecycle information?

Click below to explore more details on WIN SOURCE:

 [View 345-016-521-201 on WIN SOURCE](#)

 [EDAC Inc. Information](#)

Optimize Your Supply Chain with WIN SOURCE Solutions

-  Global Sourcing Solution
-  Obsolete Management
-  Cost Control Management
-  Shortage Management
-  Alternative Solution
-  Excess Inventory Management