

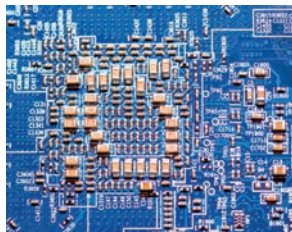

**THE DATASHEET OF  
TDCP500W102K1GV001T**



# Ceramic Component Solutions



AC Safety Certified

High Voltage SMT

High Capacitance

High Temperature

EMI Filters

SMPS Stacks

High Voltage Radials

Planar Array

Discoidal

CapStrate<sup>®</sup>

Custom Solutions

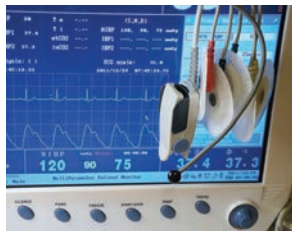

# YOUR TECHNOLOGY PARTNER



The mission of the Johanson Companies is to translate our customer needs into quality electronic components, produced in factories that are models of excellence, supported by innovative service. With over 30 years of experience, Johanson Dielectrics provides both standard and custom technology solutions tailored to your specific electronic applications.

Our standard product range includes High Voltage and AC Safety Capacitors providing solutions for Lighting, IT and Business Equipment designs. Our Capacitor line provides advanced EMI filtering and IC decoupling solutions and our High Capacitance Tanceram® products provide the highest capacitance values in the smallest cases sizes.

Customized solutions in the areas of High Temperature and High AC power ceramic capacitors are available to customers who require a partnered technology solution.

Johanson Dielectrics design and manufacturing operations are located in Sylmar, California and Zhaoqing, PRC. Our quality minded management system utilizes continuous improvement programs focused on increased product reliability, manufacturing through-put, and product performance. Our broad experience, applications support, and responsive service enhance our ability to drive down your total cost of procurement and speed your time to market.

## **HIGH FREQUENCY CERAMIC SOLUTIONS**

Johanson Technology Inc., Camarillo CA. Products include High Q Capacitors, Ceramic and Wire-wound Chip Inductors, and a broad range of LTCC based RF IPCs such as Antennas, Filters, Baluns, Couplers, Matched Filter Baluns, etc.

**[www.johansontechnology.com](http://www.johansontechnology.com)**

Johanson Dielectrics, Inc. reserves the right to make design and price changes without notice. All sales are subject to the Johanson terms and conditions, including a limited warranty and remedies for non-conforming goods or defective goods. Download the Johanson terms and conditions from our website at <https://www.johansondielectrics.com/terms-and-conditions>.



# INDEX OF PRODUCTS

## ***SURFACE MOUNT CERAMIC CAPACITORS***

---

Ceramic Capacitor Prototyping Kits	4-5
High Voltage Capacitors 250 - 6,000 VDC	6-7
Safety Capacitors 250 VAC, Y2, X1, X2	8-9
EMI Filter & Decoupling Capacitors	10-13
High Temperature 200°C Capacitors	14-15
High Capacitance Tanceram® Capacitors	16-17
SMT Multi-layer Ceramic Capacitors 10 - 200 VDC	18-19

## ***LEADED CERAMIC CAPACITORS***

---

SMPS Stacked Capacitors, 125°C & 200°C versions	20-21
Mini-SMPS Stacked Capacitors	22-23
BME Mini SMPS Capacitors	24-25
Switch-mode Radial Leaded Capacitors	26-27
High Voltage Radial Leaded Capacitors, 125°C, 200°C versions	28-29

## ***PLANAR CAPACITORS & CUSTOM CERAMIC SOLUTIONS***

---

Planar Array Capacitors	30-31
-------------------------	-------

## ***CAPSTRATE & CUSTOMER CERAMIC SOLUTIONS***

---

CapStrate® & Customer Ceramic Solutions	32-33
---	-------

## ***PART NUMBER, DIELECTRIC, PACKAGING SPECIFICATIONS, INDEX***

---

Capacitor General Electrical Characteristics and PN Breakdown	34
Capacitor Packaging	35
Index	36



# CERAMIC CAPACITOR ENGINEERING DESIGN KITS

Johanson Dielectrics, Inc. offers a variety of multi-layer chip capacitor sample kits for proto-type design work. Each kit is grouped by type, size, or voltage and contains a selection of popular values and tolerances. The chips are individually packaged in labeled plastic compartments for easy access. The general range of kit contents is described below. Specific part number details may be found at [www.johansondielectrics.com](http://www.johansondielectrics.com)



500 VDC Ceramic Chip Capacitor Kit					P/N: S-500
400 piece sample assortment of selected values from 33pF to 0.1µF					
Chip Size	Voltage Rating	Dielectric	Capacitance Range	Qty / Value	Total Qty
0805 - 1812	500 VDC	NPO, X7R	33pF to 0.1µF	10-20 pcs	400 pcs

1000 VDC Ceramic Chip Capacitor Kit					P/N: S-1KV
400 piece sample assortment of selected values from 22pF to 0.1µF					
Chip Size	Voltage Rating	Dielectric	Capacitance Range	Qty / Value	Total Qty
0805 - 2225	1000 VDC	NPO, X7R	22pF to 0.1µF	10-20 pcs	400 pcs

2000 VDC Ceramic Chip Capacitor Kit					P/N: S-2KV
300 piece sample assortment of selected values from 22pF to 0.022µF					
Chip Size	Voltage Rating	Dielectric	Capacitance Range	Qty / Value	Total Qty
1206 - 2225	2000 VDC	NPO, X7R	22pF to 0.022µF	10-20 pcs	300 pcs

X2 SAFETY CERTIFIED Ceramic Chip Capacitor Kit					P/N: S-SY3
240 piece sample assortment of selected values from 10pF to 1500 pF					
Chip Size	Voltage Rating	Dielectric	Capacitance Range	Qty / Value	Total Qty
1808	3KV DC / 250 AC	NPO, X7R	10pF to 1500 pF	20 pcs	240 pcs

X1/Y2 SAFETY CERTIFIED Ceramic Chip Capacitor Kit					P/N: S-SY2
200 piece sample assortment of selected values from 10pF to 2200 pF					
Chip Size	Voltage Rating	Dielectric	Capacitance Range	Qty / Value	Total Qty
1808 - 2220	5KV DC / 250 VAC	NPO, X7R	10pF to 2200pF	20 pcs	200 pcs

*Johanson may from time-time adjust actual kit contents based on design demand trends.  
Check the Johanson web site for design kit updates and kit content changes.*



EMI FILTER Capacitor Kit - 0402 Size					P/N: S-X07CBK
600 piece sample assortment of selected values from 1.0pF to 0.01μF					
Chip Size	Voltage Rating	Dielectric	Capacitance Range	Qty / Value	Total Qty
0402	10 - 50 VDC	NP0, X7R	1.0pF to 0.01μF	50 pcs	600 pcs

EMI FILTER Capacitor Kit - 0603 Size					P/N: S-X14CBK
700 piece sample assortment of selected values from 1.0pF to 0.01μF					
Chip Size	Voltage Rating	Dielectric	Capacitance Range	Qty / Value	Total Qty
0603	50 - 100 VDC	NP0, X7R	1.0pF to 0.01μF	50 pcs	700 pcs

POWER BYPASS Capacitor Kit - 0603 Size					P/N: S-X14-PBP
300 piece sample assortment of selected values from 0.47nF to 0.220μF					
Chip Size	Voltage Rating	Dielectric	Capacitance Range	Qty / Value	Total Qty
0603	6.3 - 100 VDC	X7R, X5R	0.47nF to 0.22μF	20 pcs	300 pcs

EMI FILTER Capacitor Kit - 0805 Size					P/N: S-X15-EMI
260 piece sample assortment of selected values from 1.0pF to 0.01μF					
Chip Size	Voltage Rating	Dielectric	Capacitance Range	Qty / Value	Total Qty
0805	50 - 100 VDC	NP0, X7R	1.0pF to 0.01μF	20 pcs	260 pcs

AUTOMOTIVE QUALIFIED capacitor kit					P/N: S-X2Y-AEC
420 piece sample assortment of selected values from 100pF to 0.22μF					
Chip Size	Voltage Rating	Dielectric	Capacitance Range	Qty / Value	Total Qty
0603, 0805, 1206	10 - 100 VDC	X7R	100pF to 0.22μF	30 pcs	420 pcs

*Johanson may from time-time adjust actual kit contents based on design demand trends.  
Check the Johanson web site for design kit updates and kit content changes.*



# HIGH VOLTAGE SURFACE MOUNT MLCCs 250 - 6,000 VDC



These high voltage capacitors feature a special internal electrode design which reduces voltage concentrations by distributing voltage gradients throughout the entire capacitor.

This unique design also affords increased capacitance values in a given case size and voltage rating. The capacitors are designed and manufactured to the general requirement of EIA198 and are subjected to a 100% electrical testing making them well suited for a wide variety of telecommunication, commercial, and industrial applications.

## APPLICATIONS

- Analog & Digital Modems
- LAN/WAN Interface
- Lighting Ballast Circuits
- Voltage Multipliers
- DC-DC Converters
- Back-lighting Inverters

Polyterm® soft termination option for demanding environments & processes available on select parts, please contact the factory.

## CASE SIZE

## CAPACITANCE SELECTION





JDI / EIA	INCHES	(MM)	RATED VOLTAGE	NP0 DIELECTRIC		X7R DIELECTRIC		
				MINIMUM	MAXIMUM	MINIMUM	MAXIMUM	
<b>R15/0805</b> 	L	.080 ±.010	(2.03 ±.25)	250 VDC	-	-	1000 pF	0.022 µF
	W	.050 ±.010	(1.27 ±.25)	500 VDC	10 pF	680 pF	1000 pF	0.010 µF
	T	.055 Max.	(1.40)	630 VDC	10 pF	560 pF	1000 pF	6800 pF
	E/B	.020 ±.010	(0.51±.25)	1000 VDC	10 pF	390 pF	100 pF	2700 pF
				250 VDC	-	-	1000 pF	0.068 µF
<b>R18/1206</b> 	L	.125 ±.010	(3.18 ±.25)	500 VDC	10 pF	1500 pF	1000 pF	0.033 µF
	W	.062 ±.010	(1.57 ±.25)	630 VDC	10 pF	1200 pF	1000 pF	0.027 µF
	T	.067 Max.	(1.70)	1000 VDC	10 pF	1000 pF	100 pF	0.010 µF
	E/B	.020 ±.010	(0.51±.25)	2000 VDC	10 pF	220 pF	100 pF	4700 pF
				3000 VDC	10 pF	82 pF	100 pF	1000 pF
				250 VDC	-	-	1000 pF	0.150 µF
<b>S41/1210</b> 	L	.125 ±.010	(3.18 ±.25)	500 VDC	10 pF	3900 pF	1000 pF	0.068 µF
	W	.095 ±.010	(2.41 ±.25)	630 VDC	10 pF	2700 pF	1000 pF	0.047 µF
	T	.080 Max.	(2.03)	1000 VDC	10 pF	1800 pF	100 pF	0.015 µF
	E/B	.020 ±.010	(0.51±.25)	2000 VDC	10 pF	560 pF	100 pF	4700 pF
				3000 VDC	10 pF	220 pF	100 pF	1000 pF
				500 VDC	10 pF	4700 pF	1000 pF	0.100 µF
<b>R29/1808</b> 	L	.185 ±.020	(4.70 ±.51)	630 VDC	10 pF	3300 pF	1000 pF	0.047 µF
	W	.080 ±.010	(2.03 ±.25)	1000 VDC	1.0 pF	2200 pF	100 pF	0.022 µF
	T	.085 Max.	(2.16)	2000 VDC	1.0 pF	820 pF	100 pF	0.010 µF
	E/B	.020 ±.010	(0.51±.25)	3000 VDC	1.0 pF	470 pF	100 pF	3300 pF
				4000 VDC	1.0 pF	180 pF	100 pF	1800 pF
				5000 VDC	1.0 pF	75 pF	47 pF	390 pF
				6000 VDC	1.0 pF	75 pF	47 pF	150 pF

Available cap. values include these significant retma values and their multiples: 1.0 1.2 1.5 1.8 2.2 2.7 3.3 3.9 4.7 5.6 6.8 8.2 (1.0 = 1.0, 10, 100, 1000, etc.) Consult factory for non-retma values and sizes or voltages not shown.

# HIGH VOLTAGE SURFACE MOUNT MLCCs 250 - 6,000 VDC

## CASE SIZE

## CAPACITANCE SELECTION

JDI / EIA	INCHES	(MM)	RATED VOLTAGE	NP0 DIELECTRIC		X7R DIELECTRIC						
				MINIMUM	MAXIMUM	MINIMUM	MAXIMUM					
<b>S43 / 1812</b> 	L W T E/B	.177 ±.012 .125 ±.010 .110 Max. .025 ±.015	(4.50 ±.30) (3.18 ±.25) (2.80) (0.64±.38)	250 VDC	-	-	0.010 µF	0.470 µF				
				500 VDC	100 pF	8200 pF	1000 pF	0.330 µF				
				630 VDC	100 pF	6800 pF	1000 pF	0.120 µF				
				1000 VDC	10 pF	5600 pF	1000 pF	0.100 µF				
				2000 VDC	10 pF	1800 pF	100 pF	0.010 µF				
				3000 VDC	10 pF	1000 pF	100 pF	4700 pF				
				4000 VDC	10 pF	390 pF	100 pF	1200 pF				
				5000 VDC	10 pF	150 pF	100 pF	820 pF				
				6000 VDC	10 pF	150 pF	10 pF	330 pF				
				<b>S49 / 1825</b> 	L W T E/B	.180 ±.010 .250 ±.010 .140 Max. .025 ±.015	(4.57 ±.25) (6.35 ±.25) (3.56) (0.64±.38)	500 VDC	100 pF	0.018 µF	0.01 µF	0.390 µF
630 VDC	100 pF	0.015 µF	0.01 µF					0.270 µF				
1000 VDC	10 pF	0.012 µF	1000 pF					0.180 µF				
2000 VDC	10 pF	5600 pF	100 pF					0.039 µF				
3000 VDC	10 pF	2200 pF	100 pF					8200 pF				
4000 VDC	10 pF	1200 pF	100 pF					2200 pF				
5000 VDC	10 pF	390 pF	100 pF					1500 pF				
6000 VDC	10 pF	390 pF	100 pF					820 pF				
<b>S47 / 2220</b> 	L W T E/B	.225 ±.015 .200 ±.015 .150 Max. .025 ±.015	(5.72 ±.38) (5.08 ±.38) (3.81) (0.64±.38)					500 VDC	1000 pF	0.018 µF	0.01 µF	0.470 µF
								630 VDC	1000 pF	0.018 µF	0.01 µF	0.270 µF
				1000 VDC	100 pF	0.015 µF	1000 pF	0.120 µF				
				2000 VDC	100 pF	5600 pF	1000 pF	0.039 µF				
				3000 VDC	10 pF	2700 pF	100 pF	0.010 µF				
				4000 VDC	10 pF	1500 pF	100 pF	2700 pF				
				5000 VDC	10 pF	470 pF	100 pF	1500 pF				
				6000 VDC	10 pF	470 pF	100 pF	820 pF				
				<b>S48 / 2225</b> 	L W T E/B	.225 ±.010 .255 ±.015 .160 Max. .025 ±.015	(5.72 ±.25) (6.48 ±.38) (4.06) (0.64±.38)	500 VDC	1000 pF	0.027 µF	0.01 µF	0.560 µF
								630 VDC	1000 pF	0.022 µF	0.01 µF	0.390 µF
1000 VDC	100 pF	0.018 µF	1000 pF					0.180 µF				
2000 VDC	100 pF	8200 pF	1000 pF					0.056 µF				
3000 VDC	10 pF	3300 pF	100 pF					0.012 µF				
4000 VDC	10 pF	1800 pF	100 pF					3300 pF				
5000 VDC	10 pF	470 pF	100 pF					2700 pF				
6000 VDC	10 pF	470 pF	100 pF					1200 pF				

Available cap. values include these significant retma values and their multiples: 1.0 1.2 1.5 1.8 2.2 2.7 3.3 3.9 4.7 5.6 6.8 8.2 (1.0 = 1.0, 10, 100, 1000, etc.) Consult factory for non-retma values and sizes or voltages not shown.

## ELECTRICAL CHARACTERISTICS

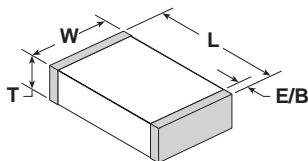

Meets the standard NP0 & X7R dielectric specifications listed on page 79

**DIELECTRIC WITHSTANDING VOLTAGE** DWV = 1.5 X rated WVDC for ratings 500-999 WVDC,  
DWV = 1.2 X rated WVDC for ratings ≥ 1,000 WVDC

NOTE: Capacitors may require a surface coating to prevent external arcing. Solder mask should not be used beneath capacitors. For more information see JDI Tech Note "Surface Arc Season"

## HOW TO ORDER HIGH VOLTAGE SURFACE MOUNT

P/N written: 202R18W102KV4E

202	R18	W	102	K	V	4	E
VOLTAGE	SIZE	DIELECTRIC	CAPACITANCE	TOLERANCE	TERMINATION	MARKING	PACKING
501 = 500 V 631 = 630 V 102 = 1000 V 202 = 2000 V 302 = 3000 V 402 = 4000 V 502 = 5000 V 602 = 6000 V	R15 = 0805 R18 = 1206 R29 = 1808 S41 = 1210 S43 = 1812 S47 = 2220 S48 = 2225 S49 = 1825	N = NP0 W = X7R	1st two digits are significant; third digit denotes number of zeros. 102 = 1000 pF 104 = 0.10 µF	J = ± 5% K = ± 10% M = ± 20%	V = Ni Barrier with 100% Sn Plating (Matte)  F = Polyterm flexible termination T = SnPb	4 = Unmarked 6 = EIA Code	E = Embossed 7" T = Punched 7"  No code = bulk Tape specs. per EIA RS481



# AC SAFETY CAPACITORS



Johanson Dielectrics Type SC ceramic chip capacitors are designed for AC voltage surge and lightning protection in line-to-ground interface applications in computer networks, modem, facsimile and other equipment.

Johanson's safety capacitor offering includes four different case sizes in NPO and X7R dielectric materials.

These devices are surface mount ready with barrier terminations and tape and reel packaging.

Information on capacitor safety ratings and certification details may be found below.

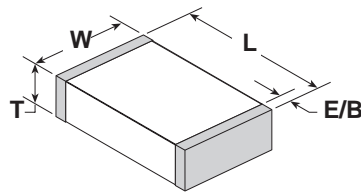







Polyterm® soft termination option for demanding environments & processes available on select parts, please contact the factory.

SAFETY RATING	VOLTAGE RATING	WITHSTANDING VOLTAGE	IMPULSE VOLTAGE	CASE SIZE	JOHANSON ORDERING P/N
X2	250 VAC	1,500 VAC	2,500 V	1808	302R29____V3E-****-SC
STANDARDS: IEC/EN 60384-14:2013+A1:2016 • UL 60384-14 CERTIFICATIONS: TUV T 72210484 • UL File E472557 & E212609					
X2	250 VAC	1,500 VAC	2,500 V	1812	302S43____V3E-****-SC
STANDARDS: IEC/EN 60384-14:2013+A1:2016 • UL 60384-14 CERTIFICATIONS: TUV T 72210484 • UL File E472557 & E212609					
X1/Y2	250 VAC	1,500 VAC	5,000 V	1808	502R29____V3E-****-SC
STANDARDS: IEC/EN 60384-14:2013+A1:2016 • UL 60384-14 CERTIFICATIONS: TUV T 72210484 • UL File E472557					
X1/Y2	250 VAC	1,500 VAC	5,000 V	1812	502S43____V3E-****-SC
STANDARDS: IEC/EN 60384-14:2013+A1:2016 • UL 60384-14 CERTIFICATIONS: TUV T 72210484 • UL File E472557					
X1/Y2	250 VAC	1,500 VAC	5,000 V	2211	502R30____V3E-****-SC
STANDARDS: IEC/EN 60384-14:2013+A1:2016 • UL 60384-14 CERTIFICATIONS: TUV T 72210484 • UL File E472557					
X1/Y2	250 VAC	1,500 VAC	5,000 V	2220	502S47____V3E-****-SC
STANDARDS: IEC/EN 60384-14:2013+A1:2016 • UL 60384-14 CERTIFICATIONS: TUV T 72210484 • UL File E472557					

X Capacitors are defined as suitable for use in situations where failure of the capacitor would not lead to danger of electric shock.

Y Capacitors are defined as suitable for use in situations where failure of the capacitor could lead to danger of electric shock.

## SAFETY CERTIFIED

		INCHES	(MM)	5 pF	10 pF	12 pF	15 pF	18 pF	22 pF	27 pF	33 pF	47 pF	56 pF	68 pF	100 pF	120 pF	150 pF	180 pF	220 pF	270 pF	330 pF	470 pF	560 pF	680 pF	1000 pF	1200 pF	1500 pF	1800 pF	2200 pF	2700 pF	3300 pF	4700 pF
R29 / 1808  X2	L	.185 ±.015	(4.70 ±.38)																			DIELECTRIC NPO										
	W	.080 ±.010	(2.03 ±.25)																													
	T	.085 Max.	(2.16)																													
	E/B	.020 ±.010	(0.51±.25)																													
R29 / 1808  X1/Y2	L	.185 ±.015	(4.70 ±.38)																													
	W	.080 ±.015	(2.03 ±.38)																													
	T	.085 Max.	(2.16)																													
	E/B	.020 ±.010	(0.51±.25)																													
S43 / 1812  X2	L	.175 ±.010	(4.45 ±.25)																													
	W	.125 ±.010	(3.18 ±.25)																													
	T	.115 Max.	(2.92)																													
	E/B	.025 ±.015	(0.64±.38)																													
S43 / 1812  X1/Y2	L	.175 ±.010	(4.45 ±.25)																													
	W	.125 ±.010	(3.18 ±.25)																													
	T	.115 Max.	(2.92)																													
	E/B	.025 ±.015	(0.64±.38)																													
R30 / 2211  X1/Y2	L	.225 ±.016	5.72 ±.40																													
	W	.110 ±.010	(2.80 ±.25)																													
	T	.115 Max.	(2.92)																													
	E/B	.020 ±.010	(0.51±.25)																													
S47 / 2220  X1/Y2	L	.225 ±.015	(5.72 ±.38)																													
	W	.200 ±.015	(5.08 ±.38)																													
	T	.150 Max.	(3.81)																													
	E/B	.025 ±.015	(0.64±.38)																													

### HOW TO ORDER AC SAFETY CAPACITORS

P/N written: 302R29W102MV3E-\*\*\*\*-SC

502	R29	W	102	M	V	3	E	****-SC
VOLTAGE	SIZE	DIELECTRIC	CAPACITANCE	TOLERANCE	TERMINATION	MARKING	PACKING	TYPE
302 = 250VAC [2500V Impulse] 502 = 250VAC [5000V Impulse]	R29=1808 R30=2211 S43=1812 S47=2220 AC2=2220	N = NPO W = X7R	1st two digits are significant; third digit denotes number of zeros, R = decimal. 102 = 1000 pF 104 = 0.10 µF 5R0 = 5.0pF	J = ± 5% K = ± 10% M = ± 20%	V = NI Barrier with 100% Sn Plating (Matte)  F = Polyterm flexible termination	3 = Required Safety Mark	E = Embossed 7" U = Embossed 13"  No code = bulk  Tape specs. per EIA RS481	SC = Safety Certified



# EMI® FILTER & DECOUPLING CAPACITORS

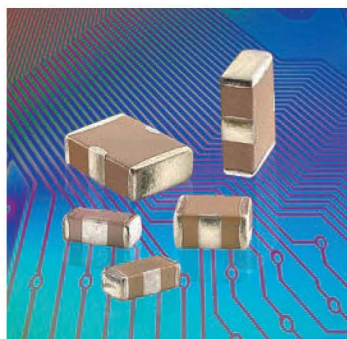

EMI® filter capacitors employ a unique, patented low inductance design featuring two balanced capacitors that are immune to temperature, voltage and aging performance differences. These components offer superior decoupling and EMI filtering performance, virtually eliminate parasitics, and can replace multiple capacitors and inductors saving board space and reducing assembly costs.

## ADVANTAGES

- One device for EMI suppression or decoupling
- Replace up to 7 components with one EMI
- Differential and common mode attenuation
- Matched capacitance line to ground, both lines
- Low inductance due to cancellation effect

## APPLICATIONS

- Amplifier Filter & Decoupling
- High Speed Data Filtering
- EMC I/O Filtering
- FPGA / ASIC /  $\mu$ -P Decoupling
- DDR Memory Decoupling

Automotive version (AEC-Q200) available for many values: please see details in the below table of capacitance values. Please contact us if another value is needed for automotive application

EMI Filtering (1 Y-Cap.)		<10pF	10pF	22pF	27pF	33pF	47pF	100pF	220pF	470pF	1000pF	1500pF	2200pF	4700pF	.01 $\mu$ F	.015 $\mu$ F	.022 $\mu$ F	.039 $\mu$ F	.047 $\mu$ F	0.10 $\mu$ F	0.18 $\mu$ F	0.22 $\mu$ F	0.33 $\mu$ F	0.40 $\mu$ F	0.47 $\mu$ F	1.0 $\mu$ F	
Power Bypass (2 Y-Caps.)		<20pF	20pF	44pF	54pF	66pF	94pF	200pF	440pF	940pF	2000pF	3000pF	4400pF	9400pF	.02 $\mu$ F	.030 $\mu$ F	.044 $\mu$ F	.078 $\mu$ F	.094 $\mu$ F	0.20 $\mu$ F	0.36 $\mu$ F	0.44 $\mu$ F	0.66 $\mu$ F	0.80 $\mu$ F	0.94 $\mu$ F	2.0 $\mu$ F	
SIZE	CAP. CODE	XR	100	220	270	330	470	101	221	471	102	152	222	472	103	153	223	393	473	104	184	224	334	404	474	105	
0402 (X07)	NP0	50	50	50	50	50	50	50																			
	X7R								50	50	50	50	50	50	16												
0603 (X14)	NP0	100	100	100	100	100	100	50	50																		
	X7R						100	100	100	100	100	100	100	100	50	25	25		16	10		10					
0805 (X15)	NP0		100	100	100	100	100	100	100	50																	
	X7R						100	100	100	100	100	100	100	100	50	50		50	25								
1206 (X18)	NP0										100																
	X7R														100	100	100		100	100*		16	16		10		
1210 (X41)	X7R														500					100		100	100		25	16	
1410 (X44)	X7R															500								100			
1812 (X43)	X7R																	500							100		

□ Automotive version currently available for those values only

\* Also proposed with a 50V rating (500X18W104MV4E) instead of 100V

Contact factory for part combinations not shown.

Filtering capacitance is specified as Line-to-Ground (Terminal A or B to G)

Power Bypass capacitance is specified Power-to-Ground (A + B to G)

Rated voltage is from line to ground in Circuit 1, power to ground in Circuit 2.

## HOW TO ORDER EMI® CAPACITORS

P/N written: 101X14W102MV4T

100	X14	W	102	M	V	4	T	+AQ
VOLTAGE	SIZE	DIELECTRIC	CAPACITANCE	TOLERANCE	TERMINATION	MARKING	PACKING	QUALIFICATION
6R3 = 6.3 V 100 = 10 V 160 = 16 V 250 = 25 V 500 = 50 V 101 = 100 V 501 = 500 V	X07 = 0402 X14 = 0603 X15 = 0805 X18 = 1206 X41 = 1210 X44 = 1410 X43 = 1812	N = NP0 W = X7R	1st two digits are significant; third digit denotes number of zeros, R = decimal. 102 = 1000 pF 104 = 0.10 $\mu$ F 5R6 = 5.6pF	M = $\pm$ 20% * D = $\pm$ 0.50 pF *Values < 10 pF only	V = NI Barrier with 100% Tin Plating (Matte) F = Polyterm flexible termination T = SnPb	4 = Unmarked (Not available)	E = Embossed 7" T = Punched 7" No code = bulk Tape specs. per EIA RS481	AEC-Q200 Qualification * (optional)



## EMI Filtering Scc21

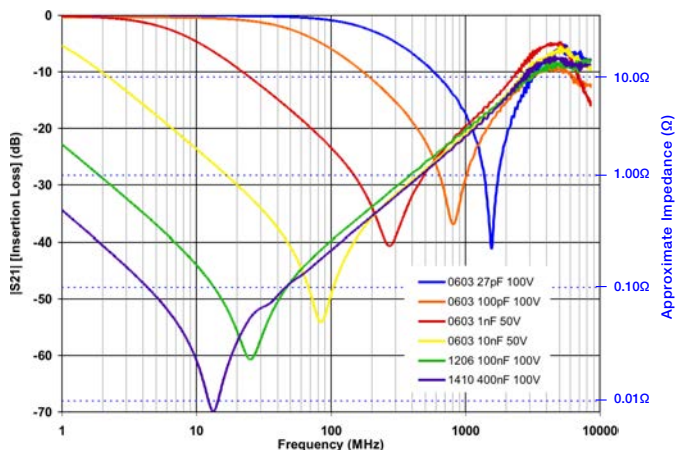
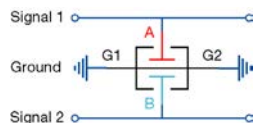

## Power Bypass S21

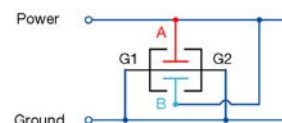

Labeled capacitance values below follow the P/N order code (single Y cap value)  
Effective capacitance measured in Circuit 2 is 2X of the labeled single Y cap value.

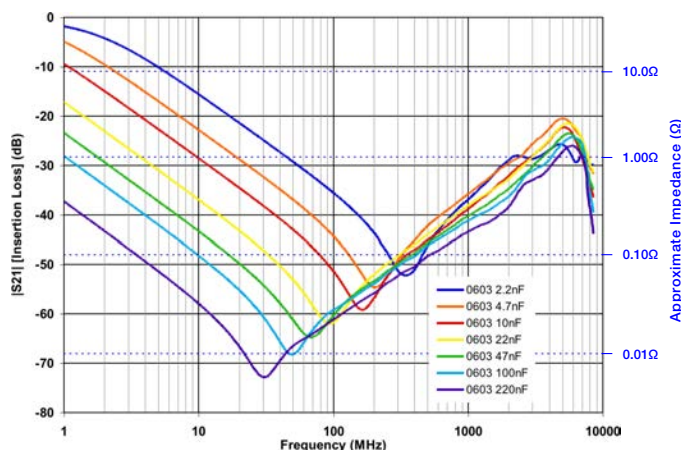

More data at <https://s21plotter.johansondielectrics.com/>

## ELECTRICAL CHARACTERISTICS

	NP0	X7R
TEMPERATURE COEFFICIENT:	0±30ppm/°C (-55 to +125°C)	±15% (-55 to +125°C)
DIELECTRIC STRENGTH:	Vrated ≤100VDC: DWV = 2.5 X WVDC, 25°C, 50mA max. Vrated = 500VDC: DWV = 1.5 X WVDC, 25°C, 50mA max.	
DISSIPATION FACTOR:	0.1% max.	WVDC ≥ 50 VDC: 2.5% max. WVDC = 25 VDC: 3.5% max. WVDC = 10-16 VDC: 5.0% max. WVDC = 6.3 VDC: 10% max.
INSULATION RESISTANCE (MIN. @ 25°C, WVDC)	C ≤ 0.047μF: 1000 ΩF or 100 GΩ, whichever is less C > 0.047μF: 500 ΩF or 10 GΩ, whichever is less	
TEST CONDITIONS:	C > 100 pF; 1kHz ±50Hz; 1.0±0.2 VRMS C ≤ 100 pF; 1Mhz ±50kHz; 1.0±0.2 VRMS	1.0kHz±50Hz @ 1.0±0.2 Vrms
OTHER:	See page 81 for additional dielectric specifications.	

### Cross-sectional View

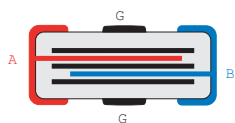

### Dimensional View

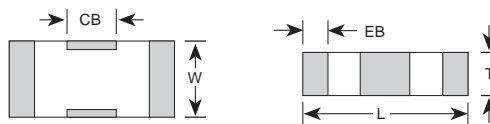

## CASE SIZE

	0402 (X07)		0603 (X14)		0805 (X15)		1206 (X18)		1210 (X41)		1410 (X44)		1812 (X43)	
	IN	MM	IN	MM	IN	MM	IN	MM	IN	MM	IN	MM	IN	MM
L	0.045 ± 0.003	1.143 ± 0.076	0.064 ± 0.005	1.626 ± 0.127	0.080 ± 0.008	2.032 ± 0.203	0.124 ± 0.010	3.150 ± 0.254	0.125 ± 0.010	3.175 ± 0.254	0.140 ± 0.010	3.556 ± 0.254	0.174 ± 0.010	4.420 ± 0.254
W	0.025 ± 0.003	0.635 ± 0.076	0.035 ± 0.005	0.889 ± 0.127	0.050 ± 0.008	1.270 ± 0.203	0.063 ± 0.010	1.600 ± 0.254	0.098 ± 0.010	2.489 ± 0.254	0.098 ± 0.010	2.490 ± 0.254	0.125 ± 0.010	3.175 ± 0.254
T	0.020 max	0.508 max	0.026 max	0.660 max	0.040 max	1.016 max	0.050 max	1.270 max	0.070 max	1.778 max	0.070 max	1.778 max	0.090 max	2.286 max
EB	0.008 ± 0.003	0.203 ± 0.076	0.010 ± 0.006	0.254 ± 0.152	0.012 ± 0.008	0.305 ± 0.203	0.016 ± 0.010	0.406 ± 0.254	0.018 ± 0.010	0.457 ± 0.254	0.018 ± 0.010	0.457 ± 0.254	0.022 ± 0.012	0.559 ± 0.305
CB	0.012 ± 0.003	0.305 ± 0.076	0.018 ± 0.004	0.457 ± 0.102	0.022 ± 0.005	0.559 ± 0.127	0.040 ± 0.005	1.016 ± 0.127	0.045 ± 0.005	1.143 ± 0.127	0.045 ± 0.005	1.143 ± 0.127	0.045 ± 0.005	1.143 ± 0.127



# EMI FILTER & DECOUPLING CAPACITORS

## THE EMI DESIGN - A BALANCED, LOW ESL, "CAPACITOR CIRCUIT"

The EMI capacitor design starts with standard 2 terminal MLC capacitor's opposing electrode sets, A & B, and adds a third electrode set (G) which surround each A & B electrode. The result is a highly versatile three node capacitive circuit containing two tightly matched, low inductance capacitors in a compact, four-terminal SMT chip.

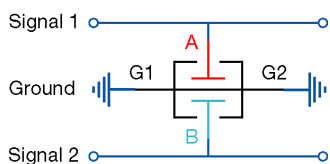
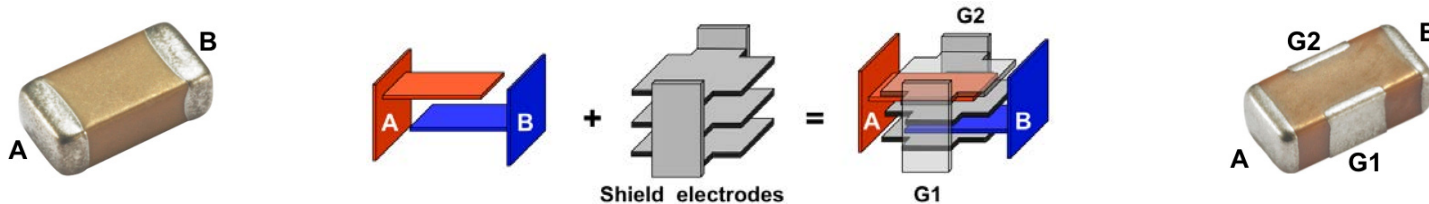

### EMI FILTERING:

The EMI component contains two shunt or "line-to-ground" Y capacitors. Ultra-low ESL (equivalent series inductance) and tightly matched inductance of these capacitors provides unequalled high frequency Common-Mode noise filtering with low noise mode conversion. EMI components reduce EMI emissions far better than unbalanced discrete shunt capacitors or series inductive filters. Differential signal loss is determined by the cut off frequency of the single line-to-ground (Y) capacitor value of an EMI.

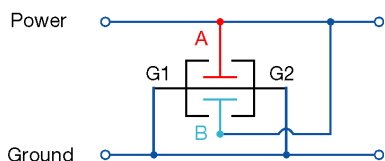

### POWER BYPASS / DECOUPLING

For Power Bypass applications, EMI's two "Y" capacitors are connected in parallel. This doubles the total capacitance and reduces their mounted inductance by 80% or 1/5th the mounted inductance of similar sized MLC capacitors enabling high-performance bypass networks with far fewer components and vias. Low ESL delivers improved High Frequency performance into the GHz range.

## GSM RFI ATTENUATION IN AUDIO & ANALOG

GSM handsets transmit in the 850 and 1850 MHz bands using a TDMA pulse rate of 217Hz. These signals cause the GSM buzz heard in a wide range of audio products from headphones to concert hall PA systems or "silent" signal errors created in medical, industrial process control, and security applications. Testing was conducted where an 840MHz GSM handset signal was delivered to the inputs of three different amplifier test circuit configurations shown below whose outputs were measured on a HF spectrum analyzer.

- 1) No input filter, 2 discrete MLC 100nF power bypass caps.
- 2) 2 discrete MLC 1nF input filter, 2 discrete MLC 100nF power bypass caps.
- 3) A single EMI 1nF input filter, a single EMI 100nF power bypass cap.

EMI configuration provided a nearly flat response above the ambient and up to 10 dB improved rejection than the conventional MLCC configuration.

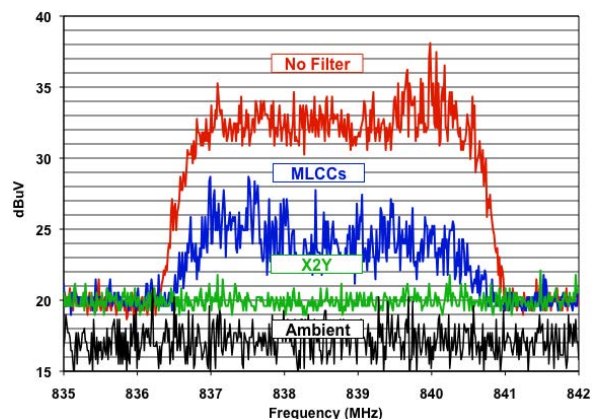

## AMPLIFIER INPUT FILTER EXAMPLE

In this example, a single Johanson EMI component was used to filter noise at the input of a DC instrumentation amplifier. This reduced component count by 3-to-1 and costs by over 70% vs. conventional filter components that included 1% film Y-capacitors.

Parameter	EMI 10nF	Discrete 10nF, 2 @ 220 pF	Comments
DC offset shift	< 0.1 $\mu$ V	< 0.1 $\mu$ V	Referred to input
Common mode rejection	91 dB	92 dB	

Source: Analog Devices, "A Designer's Guide to Instrumentation Amplifiers (2nd Edition)" by Charles Kitchin and Lew Counts

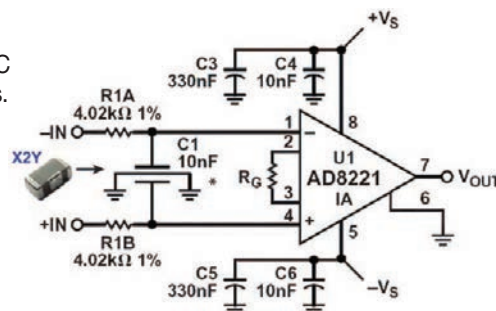

## COMMON MODE CHOKE REPLACEMENT

- Superior High Frequency Emissions Reduction
  - Smaller Sizes, Lighter Weight
  - No Current Limitation
  - Vibration Resistant
  - No Saturation Concerns
- See our website for a detailed application note with component test comparisons and circuit emissions measurements.

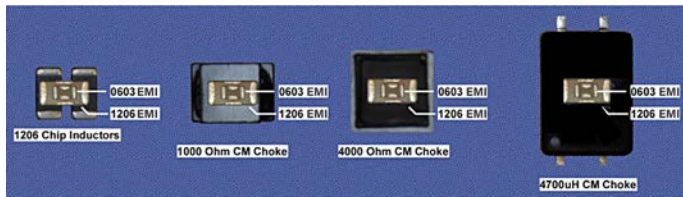

## Measured Common Mode Rejection

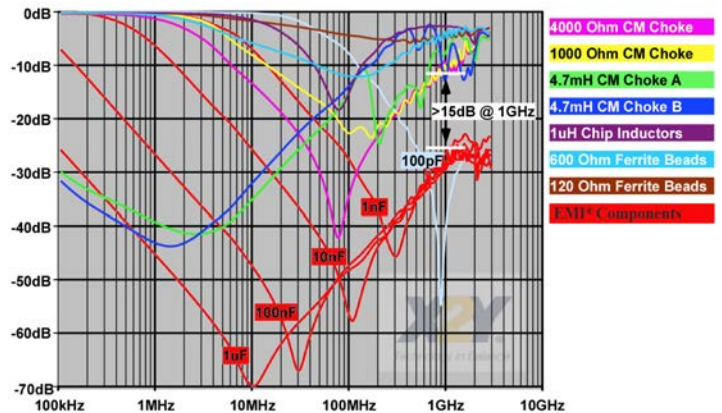

## PARALLEL CAPACITOR SOLUTION

A common design practice is to parallel decade capacitance values to extend the high frequency performance of the filter network. This causes an unintended and often over-looked effect of anti-resonant peaks in the filter networks combined impedance. EMI's very low mounted inductance allows designers to use a single, higher value part and completely avoid the anti-resonance problem. The impedance graph on right shows the combined impedance of a 1nF, 10nF & 100nF MLC in parallel in RED. The MLC networks anti-resonance peaks are nearly 10 times the desired impedance. A 100nF and 47nF EMI are plotted in BLUE and GREEN. (The total capacitance of EMI (Circuit 2) is twice the value, or 200nF and 98nF in this example.) The single EMI is clearly superior to the three paralleled MLCs.



## EMI HIGH PERFORMANCE POWER BYPASS - IMPROVE PERFORMANCE, REDUCE SPACE & VIAS

Actual measured performance of two high performance SerDes FPGA designs demonstrate how a 13 component EMI bypass network significantly out performs a 38 component MLC network.

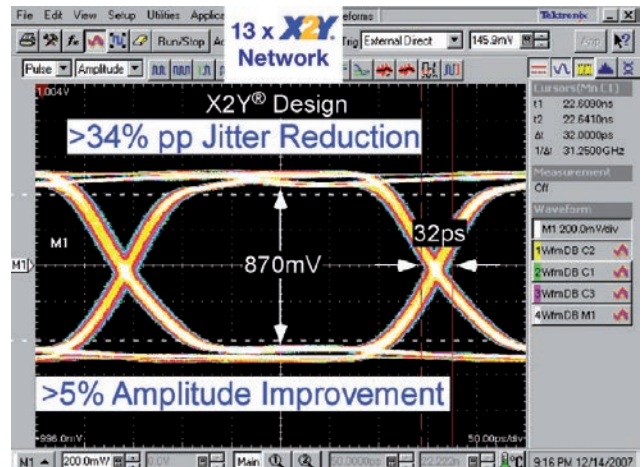
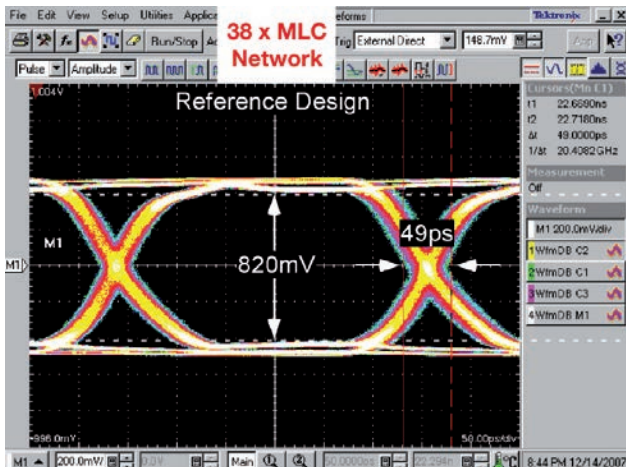
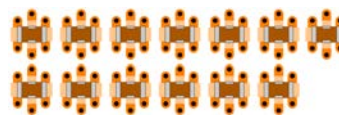
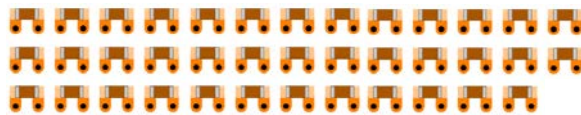

# HIGH TEMPERATURE SURFACE MOUNT MLCCs 200°C



Johanson's high temperature MLCC series exhibit stable performance across an extended operating temperature range of -55°C to +200°C. Both Class I and Class II parts are available with DC voltage ratings of 50, 100 and 200V satisfying a wide range of demanding applications.

## FEATURES

- Stable 200°C Operation
- Compact SMD Chip
- Polyterm® Termination Option
- Sn-Pb Termination Option

## APPLICATIONS

- Deep Hole Drilling Electronics
- High Temperature Modules
- Industrial Equipment
- Automotive • Avionics

## ELECTRICAL CHARACTERISTICS

	NP0	X7R
OPERATING RANGE:	-55 to +200°C	-55 to +200°C
TEMPERATURE COEFFICIENT:	0±30ppm/°C (-55to+125°C)	0±15% (-55to+125°C)
200°C CAP. DROP:	-0.5% max.	-45% max.
DISSIPATION FACTOR:	0.001 (0.1%) max.	0.020 (2.0%) max.
AGING RATE:	None	<1.0% per decade
INSULATION RESISTANCE:	25°C IR >100GΩ or 1000ΩF (whichever is less)	
WITHSTANDING VOLTAGE:	2.5 X WVDC for ratings ≤ 200 VDC 1.5 X WVDC for ratings 201-500 VDC	
TEST CONDITIONS:	C > 100 pF; 1kHz ±50Hz; 1.0±0.2 VRMS C ≤ 100 pF; 1Mhz ±50kHz; 1.0±0.2 VRMS	

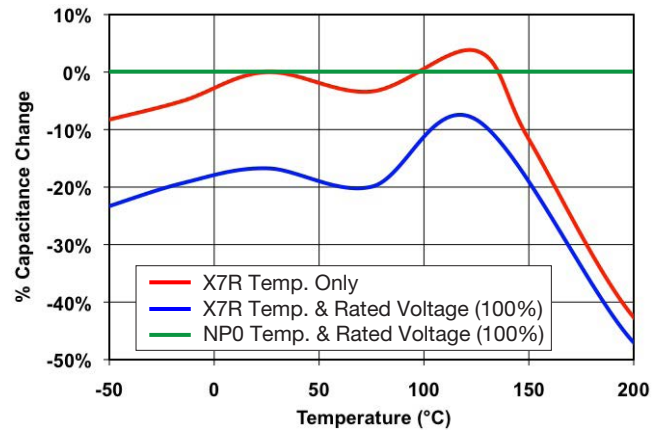





## MECHANICAL CHARACTERISTICS

			RATED VOLTAGE	NP0 DIELECTRIC		X7R DIELECTRIC	
				MINIMUM	MAXIMUM	MINIMUM	MAXIMUM
T07/0402	Inches (mm)	L	25 VDC	10 pF	270 pF	100 pF	4700 pF
		W	50 VDC	10 pF	120 pF	100 pF	1500 pF
		T	100 VDC	10 pF	82 pF	10 pF	390 pF
		E/B	200 VDC	10 pF	50 pF	10 pF	100 pF
T14/0603	Inches (mm)	L	25 VDC	10 pF	820 pF	1000 pF	0.022 μF
		W	50 VDC	10 pF	330 pF	1000 pF	0.010 μF
		T	100 VDC	10 pF	220 pF	100 pF	2200 pF
		E/B	200 VDC	10 pF	120 pF	100 pF	560 pF
T15/0805	Inches (mm)	L	25 VDC	100 pF	2200 pF	1000 pF	0.100 μF
		W	50 VDC	100 pF	1500 pF	1000 pF	0.033 μF
		T	100 VDC	100 pF	1000 pF	1000 pF	0.010 μF
		E/B	200 VDC	10 pF	680 pF	100 pF	2200 pF

# HIGH TEMPERATURE SURFACE MOUNT MLCCs 200°C

## MECHANICAL CHARACTERISTICS

				RATED VOLTAGE	NP0 DIELECTRIC		X7R DIELECTRIC	
					MINIMUM	MAXIMUM	MINIMUM	MAXIMUM
<b>T18/1206</b> 		Inches	(mm)	25 VDC	100 pF	6800 pF	1000 pF	0.220 μF
	L	.125 ±.010	(3.17 ±.25)	50 VDC	100 pF	3300 pF	1000 pF	0.100 μF
	W	.062 ±.010	(1.57 ±.25)	100 VDC	100 pF	2200 pF	1000 pF	0.022 μF
	T	.067 Max.	(1.70)	200 VDC	100 pF	1500 pF	1000 pF	5600 pF
	E/B	.020±.010	(0.51±.25)					
<b>T41/1210</b> 		Inches	(mm)	25 VDC	1000 pF	0.015 μF	0.047 μF	0.470 μF
	L	.125 ±.010	(3.18 ±.25)	50 VDC	1000 pF	5600 pF	0.047 μF	0.220 μF
	W	.095 ±.010	(2.41 ±.25)	100 VDC	100 pF	4700 pF	0.047 μF	0.056 μF
	T	.090 Max.	(2.28)	200 VDC	100 pF	3300 pF	0.0047 μF	0.015 μF
	E/B	.020±.010	(0.51±.25)					
<b>T43/1812</b> 		Inches	(mm)	25 VDC	1000 pF	0.033 μF	0.047 μF	1.000 μF
	L	.175 ±.010	(4.45 ±.25)	50 VDC	1000 pF	0.012 μF	0.047 μF	0.470 μF
	W	.125 ±.010	(3.17 ±.25)	100 VDC	1000 pF	0.010 μF	0.047 μF	0.180 μF
	T	.110 Max.	(2.80)	200 VDC	1000 pF	8200 pF	0.047 μF	0.047 μF
	E/B	.025±.015	(0.64±.38)					
<b>T49/1825</b> 		Inches	(mm)	25 VDC	1000 pF	0.033 μF	0.10 μF	2.200 μF
	L	.180 ±.010	(4.57 ±.25)	50 VDC	1000 pF	0.027 μF	0.10 μF	1.000 μF
	W	.250 ±.010	(6.35 ±.25)	100 VDC	1000 pF	0.022 μF	0.10 μF	0.560 μF
	T	.140 Max.	(3.56)	200 VDC	1000 pF	0.018 μF	0.10 μF	0.150 μF
	E/B	.025±.015	(0.64±.38)					
<b>T48/2225</b> 		Inches	(mm)	25 VDC	1000 pF	0.100 μF	0.10 μF	3.300 μF
	L	.225 ±.010	(5.72 ±.25)	50 VDC	1000 pF	0.039 μF	0.10 μF	1.500 μF
	W	.255 ±.015	(6.48 ±.38)	100 VDC	1000 pF	0.033 μF	0.10 μF	0.820 μF
	T	.160 Max.	(4.06)	200 VDC	1000 pF	0.022 μF	0.10 μF	0.220 μF
	E/B	.025±.015	(0.64±.38)					

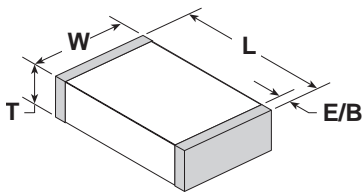

See page 81 for additional dielectric specifications.

## HOW TO ORDER 200°C MLCCs

P/N written: 500T14W103KV4E

500	T14	W	103	K	V	4	E
VOLTAGE	SIZE	DIELECTRIC	CAPACITANCE	TOLERANCE	TERMINATION	MARKING	PACKING
250 = 25 V 500 = 50 V 101 = 100 V 201 = 200 V	T07 = 0402 T14 = 0603 T15 = 0805 T18 = 1206 T41 = 1210 T43 = 1812 T49 = 1825 T48 = 2225	N = NP0 W = X7R	1st two digits are significant; third digit denotes number of zeros.  102 = 1000 pF 103 = 0.01 μF 104 = 0.10 μF	<b>NP0</b> J = ± 5% K = ± 10%  <b>X7R</b> K = ± 10% M = ± 20%	V = Ni Barrier w/ 100% Sn Plating (150°C) T = Ni Barrier w/ 95%Sn/5%Pb Plating (150°C) E = Ni Barrier w/ 100% Sn Plating (180°C) P = Palladium Silver Pd-Ag (200°C)	4 = Unmarked (Not available)	E = Embossed 7" T = Punched 7"  No code = bulk  Tape specs. per EIA RS481



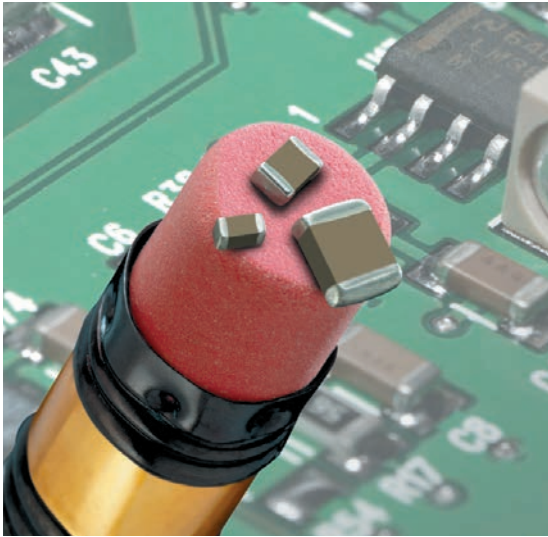

TANCERAM® chip capacitors can replace tantalum capacitors in many applications and offer several key advantages over traditional tantalums. Because TANCERAM® capacitors exhibit extremely low ESR, equivalent circuit performance can often be achieved using considerably lower capacitance values. Low DC leakage reduces current drain, extending the battery life of portable products. TANCERAM® high DC breakdown voltage ratings offer improved reliability and eliminate large voltage de-rating common when designing with tantalums.

## ADVANTAGES

- Low ESR
- Higher Surge Voltage
- Reduced CHIP Size
- Higher Insulation Resistance
- Low DC Leakage
- Non-polarized Devices
- Improved Reliability
- Higher Ripple Current

## APPLICATIONS

- Switching Power Supply Smoothing (Input/Output)
- DC/DC Converter Smoothing (Input/Output)
- Backlighting Inverters
- General Digital Circuits

Typical ESR Comparison

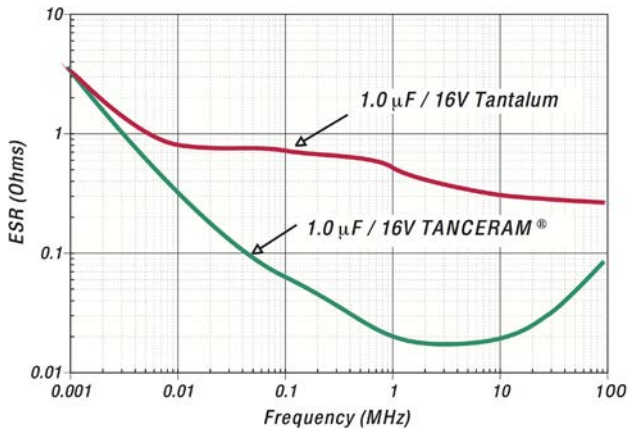

Typical Breakdown Voltage Comparison

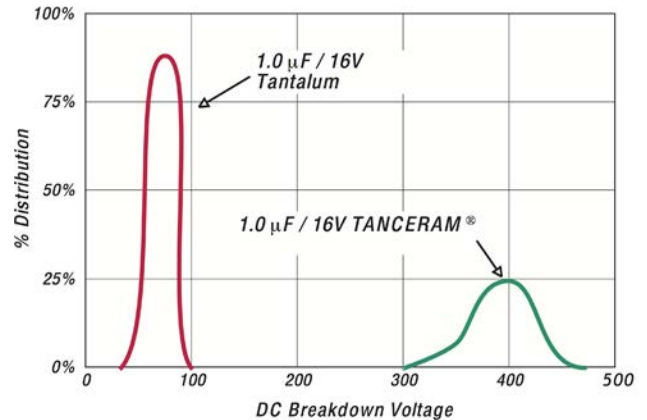

## HOW TO ORDER TANCERAM®

Part number written: 100R15X106MV4E

100	R15	X	106	M	V	4	E
<b>VOLTAGE</b>	<b>SIZE</b>	<b>DIELECTRIC</b>	<b>CAPACITANCE</b>	<b>TOLERANCE</b>	<b>TERMINATION</b>	<b>MARKING</b>	<b>PACKING</b>
6R3 = 6.3 V 100 = 10 V 160 = 16 V 250 = 25 V 500 = 50 V 101 = 100 V	See Chart	W = X7R X = X5R	1st two digits are significant; third digit denotes number of zeros. 105 = 1.00 µF 476 = 47.0 µF 107 = 100 µF	K = ±10% M = ±20%	V = Nickel Barrier with 100% Tin Plating (Matte)  T = SnPb* (*available on select parts)	4 = Unmarked	Code Type Reel E Plastic 7" T Paper 7" Tape specifications conform to EIA RS481

## CAPACITANCE SELECTION

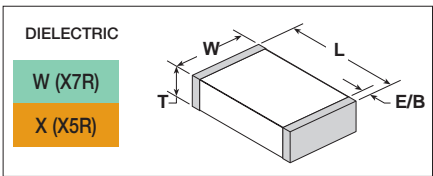

EIA / JDI	INCHES	(mm)	VDC	1.0 µF	1.5 µF	2.2 µF	3.3 µF	4.7 µF	10 µF	22 µF	47 µF	100 µF	220 µF
0201 R05 -	L .024 ±.001 W .011 ±.001 T .013 Max. EB .004 Min.	(0.60 ±.03) (0.28 ±.03) (0.33 Max.) (0.10 Min.)	Dielectric	W	X	W	X	W	X	W	X	W	X
			10										
			6.3										
			4										
			35										
0402 R07 -	L .039 ±.002 W .020 ±.002 T .022 Max. EB .002 Min.	(0.99 ±.05) (0.51 ±.05) (0.55 Max.) (0.05 Min.)	35										
			25										
			16										
			10										
			6.3										
0603 R14 -	L .063 ±.004 W .031 ±.004 T .037 Max. EB .006 Min.	(1.60 ±.10) (0.79 ±.10) (0.93 Max.) (0.15 Min.)	50										
			35										
			25										
			16										
			10										
0805 R15 -	L .079 ±.012 W .049 ±.008 T .057 Max. EB .008 Min.	(2.01 ±.30) (1.24 ±.20) (1.44 Max.) (0.20 Min.)	50										
			35										
			25										
			16										
			10										
1206 R18 -	L .126 ±.012 W .063 ±.008 T .071 Max. EB .010 Min.	(3.20 ±.30) (1.60 ±.20) (1.80 Max.) (0.25 Min.)	50										
			35										
			25										
			16										
			10										
1210 S41 -	L .126 ±.012 W .098 ±.012 T .106 Max. EB .012 Min.	(3.20 ±.30) (2.49 ±.30) (2.69 Max.) (0.30 Min.)	50										
			35										
			25										
			16										
			10										
1812 S43 -	L .177 ±.016 W .126 ±.012 T .118 Max. EB .012 Min.	(4.50 ±.41) (3.20 ±.30) (2.99 Max.) (0.30 Min.)	50										
			25										
2220 S47 -	L .220 ±.016 W .197 ±.016 T .118 Max. EB .012 Min.	(5.59 ±.41) (3.20 ±.30) (2.99 Max.) (0.30 Min.)	50										
			25										

"K" OR "M" TOLERANCE, 0201 ONLY AVAILIABLE IN M ONLY "M" TOLERANCE

### ELECTRICAL CHARACTERISTICS

DIELECTRIC:	X7R	X5R
TEMPERATURE COEFFICIENT:	±15% (-55 to +125°C)	±15% (-55 to +85°C)
DISSIPATION FACTOR:	For ≥ 50 VDC: 5% max. For ≤ 35 VDC: 10% max.	For ≥ 50 VDC: 5% max. For ≤ 35 VDC: 10% max.
INSULATION RESISTANCE (MIN. @ 25°C, WVDC)	100 ΩF or 10 GΩ, whichever is less	
DIELECTRIC STRENGTH:	2.5 X WVDC, 25°C, 50mA max.	
TEST CONDITIONS:	Capacitance values ≤ 10 µF: 1.0kHz±50Hz @ 1.0±0.2 Vrms Capacitance values > 10 µF: 120Hz±10Hz @ 0.5V±0.1 Vrms	
OTHER:	See page 81 for additional dielectric specifications.	



# SURFACE MOUNT MLCCs 10 - 200 VDC

CASE SIZE			Voltage	AVAILABLE CAPACITANCE CODE																									
JDI	Inches	(mm)		0R5	XRX	100	120	150	180	220	270	330	390	470	560	680	820	101	121	151	181	221	271	331	391	471	561	681	821
R05	0201	(0603) L .024 ±.001 W .012 ±.001 T .012 ±.001 EB .006 ±.002 (0.60 ±.03) (0.30 ±.03) (0.30 ±.03) (0.15±.05)	25V	█																									
			16V	█											█														
			10V	█											█														
			50V	█											█														
R07	0402	(1005) L .040 ±.004 W .020 ±.004 T .025 Max. EB .008 ±.004 (1.02 ±.10) (0.51 ±.10) (0.64) (0.20±.10)	50V	█											█														
			25V	█											█														
			16V	█											█														
			10V	█											█														
R14	0603	(1608) L .063 ±.008 W .032 ±.008 T .035 Max. EB .010±.005 (1.60 ±.20) (0.81 ±.20) (0.89) (.25±.13)	200V	█											█														
			100V	█											█														
			50V	█											█														
			25V	█											█														
			16V	█											█														
R15	0805	(2012) L .080 ±.010 W .050 ±.010 T .050 Max. EB .020±.010 (2.03 ±.25) (1.27 ±.25) (1.27) (0.51±.25 )	200V	█											█														
			100V	█											█														
			50V	█											█														
			25V	█											█														
			16V	█											█														
R18	1206	(3216) L .125 ±.010 W .062 ±.010 T .050 Max. EB .020 ±.010 (3.17 ±.25) (1.57 ±.25) (1.27) (0.51 ±.25)	200V	█											█														
			100V	█											█														
			50V	█											█														
			25V	█											█														
S41	1210	(3224) L .125 ±.010 W .095 ±.010 T .065 Max. EB .020 ±.010 (3.18 ±.25) (2.41 ±.25) (1.65) (0.51 ±.25)	200V												NP0														
			100V												X7R														
			50V																										
			25V																										
			16V																										
S43	1812	(4532) L .175 ±.010 W .125 ±.010 T .085 Max. EB .025 ±.015 (4.45 ±.25) (3.17 ±.25) (2.16) (0.64 ±.38)	200V																										
			100V																										
			50V																										
			25V																										

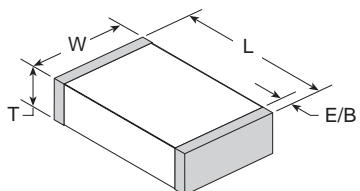

## HOW TO ORDER - SURFACE MOUNT MLCC

Part number written: 100R07W104KV4E

<b>100</b>	<b>R 07</b>	<b>W</b>	<b>104</b>	<b>K</b>	<b>V</b>	<b>4</b>	<b>E</b>
<b>VOLTAGE</b>	<b>SERIES/SIZE</b>	<b>DIELECTRIC</b>	<b>CAPACITANCE</b>	<b>TOLERANCE</b>	<b>TERMINATION</b>	<b>MARKING</b>	<b>PACKING</b>
100 = 10 V DC 160 = 16 V DC 250 = 25 V DC 500 = 50 V DC 101 = 100 V DC 201 = 200 V DC	R05 = 0201 R07 = 0402 R14 = 0603 R15 = 0805 R18 = 1206 S41 = 1210 S43 = 1812	N = NP0 W = X7R X = X5R	1st two digits are significant; third digit denotes number of zeros, R = decimal.  5R6 = 5.6 pF 100 = 10 pF 102 = 1,000 pF 474 = 0.47 μF	* B = ± 0.10 pF * C = ± 0.25 pF * D = ± 0.50 pF F = ± 1 % G = ± 2 % J = ± 5 % K = ± 10 % M = ± 20 %  *Values < 10 pF only	V = Nickel Barrier with 100% Tin Plating (Matte)  T = SnPb	3 = Special 4 = Unmarked 6 = EIA Code*  *Not available on sizes ≤ 0402	E = Embossed 7" T = Punched 7" U = Embossed 13" R = Punched 13" No code = bulk  Tape specifications on page 48. Not all tape styles are available on all parts.





# STACKED SMPS CERAMIC CAPACITORS

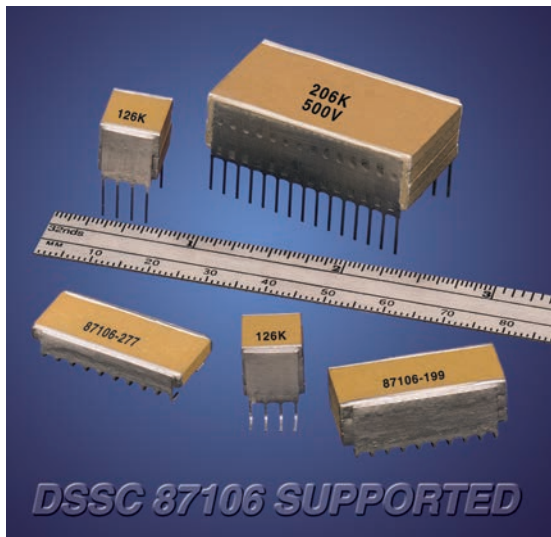

Stacked Switch-Mode ceramic capacitors feature large capacitance values and exhibit low ESR (equivalent series resistance) and low ESL (equivalent series inductance) making them well suited for high power and high frequency applications where tantalum or aluminum electrolytic capacitors may not be suitable. The P-Series feature mechanical and pin-out configurations per DSCC 87106 and 88011 drawings while the E-Series feature mechanical and pin-out configurations more common in European design applications.

## KEY FEATURES

- P-Series Approved to DSCC Drawings 87106 & 88011 MIL-PRF-49470
- New T-Series 200°C for downhole tools and aircraft engine control applications.
- E-Series Common European Lead Styles available to MIL-PRF-49470 requirements.
- NP0 & X7R Dielectrics, 50 to 500 VDC Ratings
- Low ESR / Low ESL, Ideal for SMPS Filtering Applications
- Custom Sizes, Voltages, and Values Available

## CASE SIZE

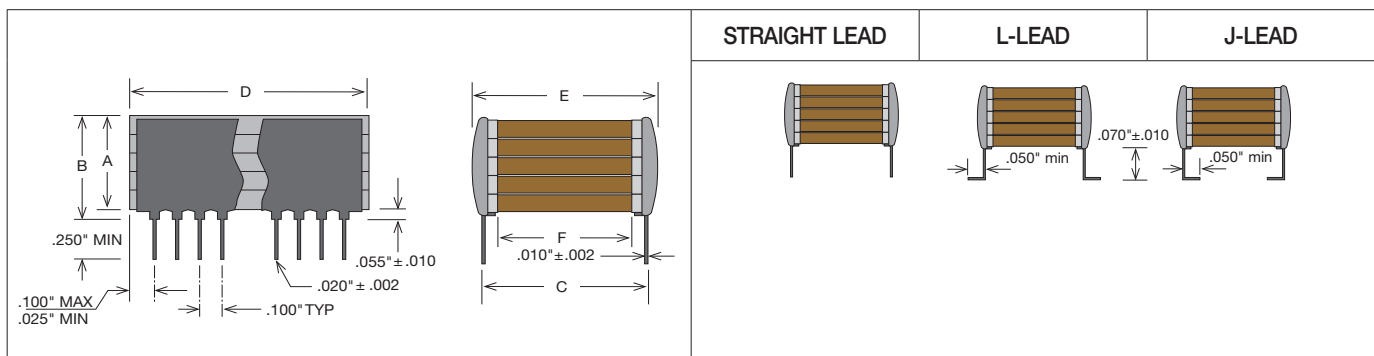

## HOW TO ORDER STACKED SMPS

Part number written: 201P03W275KJ4H

201	P03	W	275	K	J	4	H
<b>VOLTAGE</b>	<b>SIZE</b>	<b>DIELECTRIC</b>	<b>CAPACITANCE</b>	<b>TOLERANCE</b>	<b>TERMINATION</b>	<b>MARKING</b>	<b>PACKING</b>
500 = 50 V 101 = 100 V 201 = 200 V 501 = 500 V	See Chart	N = NP0 B = BX W = X7R	1st two digits are significant; third digit denotes number of zeros. 101 = 100 pF 102 = 1000 pF 103 = 0.01 μF 105 = 1.00 μF	J = ±5% K = ±10% L = ±15% M = ±20% N = ±30% Z = +80% -20% P = +100% -0%	J = "J" Leads (formed in) K = "J" Leads with reduced height of .045" ±.010" L = "L" Leads (formed out) M = "L" Leads with reduced height of .045" ±.010" N = Straight Lead	4 = Standard 3 = Specified	T = Tape and Reel H = High Reliability testing per customer requirements S = Special Part



# STACKED SMPS CERAMIC CAPACITORS

## *P-SERIES DSCC STYLE X7R CAPACITANCE / VOLTAGE SELECTION*

CASE SIZE	CHIP LAYERS	LEADS /SIDE	MECHANICAL SIZE RANGE (IN.)			X7R MAX CAPACITANCE (µF)			
			LENGTH (D)	WIDTH (E)	TMAX (B)	50V	100V	200V	500V
P05	1	3	0.275	0.300	.185	3.0	2.2	1.0	0.50
P55	5				.715	15	11	5.0	2.5
P04	1	4	0.425	0.440	.185	9.0	6.5	3.0	1.5
P54	5				.715	45	32	15	7.5
P03	1	10	1.075	0.500	.185	28	20	9.5	4.7
P53	5				.715	140	100	47	23
P01	1	20	2.075	0.500	.185	50	40	19	9.4
P51	5				.715	250	200	95	46
P02	1	15	1.535	0.870	.185	75	55	25	14
P52	5				.715	370	270	125	70
P06	1	20	2.075	1.350	.185	160	110	50	25
P56	5				.715	800	550	250	125

Please refer to our website for complete offering including NP0 & BX capacitance ranges.

## *NEW 200°C T-SERIES CAPACITANCE / VOLTAGE SELECTION*

CASE SIZE	CHIP LAYERS	LEADS /SIDE	MECHANICAL SIZE RANGE (IN.)			MAX CAPACITANCE (µF)		
			LENGTH (D)	WIDTH (E)	TMAX (B)	50V	100V	200V
T05	1	3	0.275	0.300	.185	1.20	0.68	0.33
T55	5				.715	5.60	3.30	1.50
T04	1	4	0.425	0.440	.185	2.70	1.50	0.82
T54	5				.715	15.0	8.20	3.90
T03	1	10	1.075	0.500	.185	10.0	5.60	2.70
T53	5				.715	47.0	27.0	12.0

Please refer to our website for complete offering including NP0 capacitance ranges.  
or contact our technical team @ <https://johansondielectrics.com/ask-a-question>

## *E-SERIES EUROPEAN STYLE X7R CAPACITANCE / VOLTAGE SELECTION*

CASE SIZE	CHIP LAYERS	LEADS /SIDE	MECHANICAL SIZE RANGE (MM)			X7R MAX CAPACITANCE (µF)			
			LENGTH (D)	WIDTH (E)	TMAX (B)	50V	100V	200V	500V
E24	1	3	8.7	9.2	3.8	5.0	4.0	2.5	1.0
E54	4				14.8	20	16	10	4.0
E26	1	5	13.6	14.9	3.	16	12	7.5	3.3
E56	4				14.8	64	48	30	13
E21	1	6	16.6	21.6	3.8	30	22	14	6.0
E51	4				14.8	120	88	56	24
E28	1	14	38.2	12.0	3.8	35	25	16	7.0
E58	4				14.8	140	100	64	28
E29	1	14	40.6	24.0	3.8	75	50	35	16
E59	4				14.8	300	200	140	64

Please refer to our website for complete offering including NP0 & BX capacitance ranges.



# MINI-SWITCH-MODE® CAPACITORS



JDI's Mini Switch-Mode® ceramic capacitors combine the advantages of high capacitance found in tantalum capacitors with very low ESR performance of ceramic capacitors. The “J” and “L” lead configurations replace 1825 and 2225 SMT chips to provide stress relief and prevent cracking due to thermal cycling or mechanical board flexing. Another plus of the J-lead style is that this configuration allows use of the same solder lands as the SMT chips. See the Stacked Switch-Mode section for larger values. See also the Technical Notes on soldering and handling and suggested solder lands.

## FEATURES

- High Capacitance, Small Size
- Low ESR/ESL
- Leadframe reduces thermal & mechanical stress due to board flexure and TCE mismatch

## APPLICATIONS

- DC-DC Converters
- Power Supply Input & Output Filters

## CAPACITANCE SELECTION

SIZE CODE	EIA CHIP SIZE	NP0 Max Capacitance (uF)					X7R Max Capacitance (uF)				
		25V	50V	100V	200V	500V	25V	50V	100V	200V	500V
P09	1825	0.056	0.047	0.039	0.027	0.018	1.5	1.2	0.75	0.56	0.27
P29	1825	0.11	0.094	0.078	0.054	0.036	3.0	2.4	1.5	1.1	0.54
P39	1825	0.16	0.14	0.11	0.081	0.054	4.5	3.6	2.2	1.6	0.81
P49	1825	0.22	0.18	0.15	0.10	0.07	6.0	4.8	3.0	2.2	1.0
P08	2225	0.068	0.056	0.047	0.033	0.027	2.7	2.2	1.5	1.2	0.39
P28	2225	0.13	0.11	0.094	0.066	0.054	5.4	4.4	3.0	2.4	0.78
P38	2225	0.20	0.16	0.14	0.10	0.081	8.1	6.6	4.5	3.6	1.1
P48	2225	0.27	0.22	0.18	0.13	0.10	10	8.8	6.0	4.8	1.5

# MINI-SWITCH-MODE® CAPACITORS

## CASE SIZE

DIMENSIONS APPLICABLE TO ALL SIZES:																		
	IN.	MM	P08		P09		P28		P29		P38		P39		P48		P49	
	IN.	MM	IN.	MM	IN.	MM	IN.	MM	IN.	MM	IN.	MM	IN.	MM	IN.	MM	IN.	MM
H ± .010	.070	1.78																
C TYP.	.100	2.54																
P ± .015	.065	1.65																
DIMENSIONS APPLICABLE TO SPECIFIC SIZES:																		
L MAX	.280	7.11	0.24	6.1	0.28	7.11	0.24	6.1	0.28	7.11	0.24	6.1	0.28	7.11	0.24	6.1	0.24	6.1
W MAX	.270	6.86	0.27	6.86	0.27	6.86	0.27	6.86	0.27	6.86	0.27	6.86	0.27	6.86	0.27	6.86	0.27	6.86
T MAX	.095	2.41	0.095	2.41	0.19	4.83	0.19	4.83	0.285	7.24	0.285	7.24	0.38	9.65	0.38	9.65	0.38	9.65

Note: J-Lead and L-Lead options are available on all sizes above

## ELECTRICAL CHARACTERISTICS

DIELECTRIC:	NP0	X7R
TEMPERATURE COEFFICIENT:	0 ±30ppm/°C (-55 to +125°C)	±15% (-55 to +125°C)
DISSIPATION FACTOR:	0.1% max.	2.5% max.
AGING:	None	-2.5% per decade hour
INSULATION RESISTANCE (MIN. @ 25°C, WVDC)	1000 ΩF or 100 GΩ, whichever is less	500 ΩF or 50 GΩ, whichever is less
DIELECTRIC STRENGTH:	For 500V Ratings: 750VDC, 25°C, 50mA max For 200V Ratings: 2xWVDC, 25°C, 50mA max For 25-100V Ratings: 2.5xWVDC, 25°C, 50mA max	
TEST CONDITIONS:	1kHz ±50Hz; 1.0±0.2 VRMS	
OTHER:	See page 81 for additional dielectric specifications.	

## HOW TO ORDER - MINI SWITCHMODE®

Part number written: 500P28W395KJ4U

500	P28	W	395	K	J	4	U
VOLTAGE	SIZE	DIELECTRIC	CAPACITANCE	TOLERANCE	TERMINATION	MARKING	PACKING
250 = 25 V 500 = 50 V 101 = 100 V 201 = 200 V 501 = 500 V	See Chart	N = NP0 W = X7R	1st two digits are significant; third digit denotes number of zeros. 103 = 0.01 μF 105 = 1.0 μF 106 = 10 μF	J = ±5% K = ±10% M = ±20% Z = +80% -20%	J = "J" Leads (formed in) L = "L" Leads (formed out)	3 = Standard 4 = Unmarked	U = Tape and Reel 16mm, 13" Reel NONE = Bulk pack H = High Reliability testing per customer requirements S = Special Part



# BME MINI-SWITCH-MODE® CAPACITORS

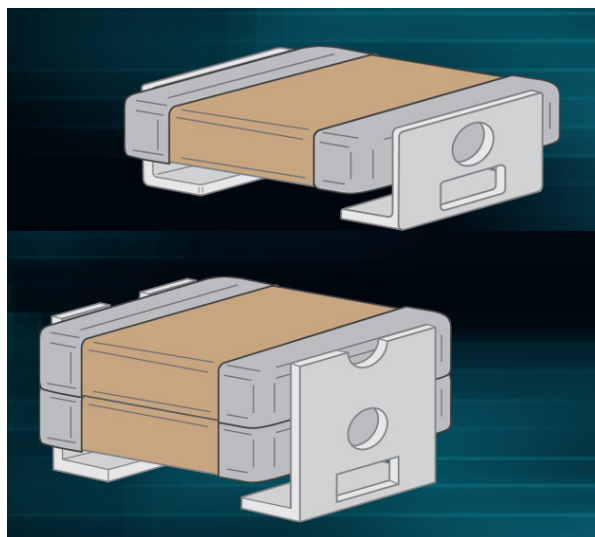

This new series of miniature switchmode power supply filter capacitors uses BME (Base Metal Electrode) construction to achieve 300-400% capacitance increases and component size reductions compared to their PME (Precious Metal Electrode) counterparts per the comparison examples below.

## BME Size / Capacitance Comparison

Technology	Chips	Volts	Max. Cap.
PME	1x 1825	50V	1.2 $\mu$ F
<b>BME</b>	<b>1x 1812</b>	<b>50V</b>	<b>4.7<math>\mu</math>F</b>
PME	2x 2225	100V	4.4 $\mu$ F
<b>BME</b>	<b>2x 2220</b>	<b>100V</b>	<b>10<math>\mu</math>F</b>

## FEATURES

- High Capacitance, Small Size
- Low ESR/ESL
- Leadframe reduces thermal & mechanical stress due to board flexure and TCE mismatch
- Green / ROHS Compliant

## APPLICATIONS

- DC-DC Converters
- Power Supply Input & Output Filters
- High Capacitance Applications Where Increased Reliability is Required

## CAPACITANCE / VOLTAGE

## CASE SIZE / PART NUMBER

CAPACITANCE RATING	DC VOLTAGE RATING	SIZE P0A 1812 SINGLE STACK		SIZE P07 2220 SINGLE STACK		SIZE P2A 1812 DOUBLE STACK		SIZE P27 2220 DOUBLE STACK		
		IN.	MM	IN.	MM	IN.	MM	IN.	MM	
2.2 $\mu$ F	100V	101P0AW225MJ4U+RC								
4.7 $\mu$ F	50V	500P0AW475MJ4U+RC								
4.7 $\mu$ F	100V			101P07W475MJ4U+RC		101P2AW475MJ4U+RC				
10 $\mu$ F	50V			500P07W106MJ4U+RC		500P2AW106MJ4U+RC				
10 $\mu$ F	100V							101P27W106MJ4U+RC		
22 $\mu$ F	50V							500P27W226MJ4U+RC		
Mechanical Dimensions										
		L MAX:	0.217	5.5	0.256	6.5	0.217	5.5	0.256	6.5
		W MAX:	0.157	4	0.217	5.5	0.157	4	0.217	5.5
		H MAX:	0.102	2.6	0.118	3	0.205	5.2	0.236	6
		h1 TYP.:	0.051	1.3	0.051	1.3	0.051	1.3	0.051	1.3
		p1 TYP.:	0.121	3.08	0.177	4.5	0.121	3.08	0.177	4.5
p2 TYP.:	0.059	1.5	0.059	1.5	0.07	1.8	0.07	1.8		

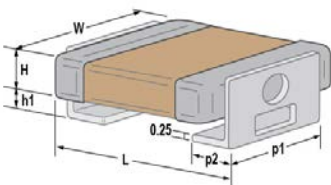
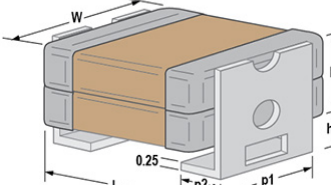
## TYPICAL APPLICATION: DC-DC CONVERTER INPUT & OUTPUT FILTERING

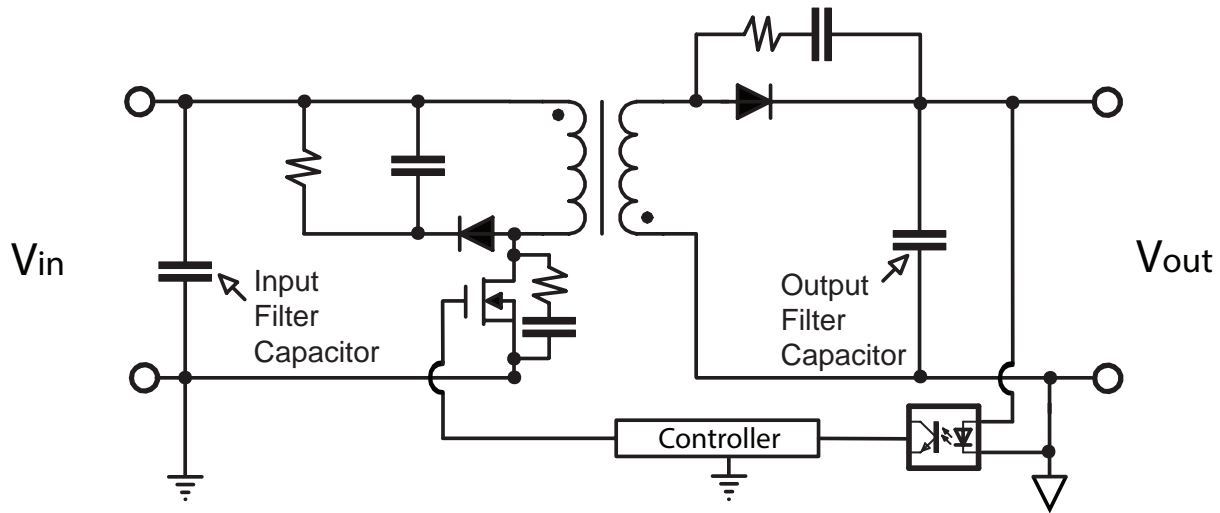

## ELECTRICAL CHARACTERISTICS

OPERATING RANGE:	-55 to +125°C
TEMPERATURE COEFFICIENT:	X7R, ±15%
DISSIPATION FACTOR:	0.025 (2.5%) max.
AGING RATE:	<2.5% per decade
INSULATION RESISTANCE:	10GΩ or 500 ΩF whichever is less
WITHSTANDING VOLTAGE:	2 X WVDC
TEST CONDITIONS:	1kHz ±50Hz; 1.0±0.2 VRMS, 25°C

BME MINI SWITCHMODE TEMPERATURE COEFFICIENT

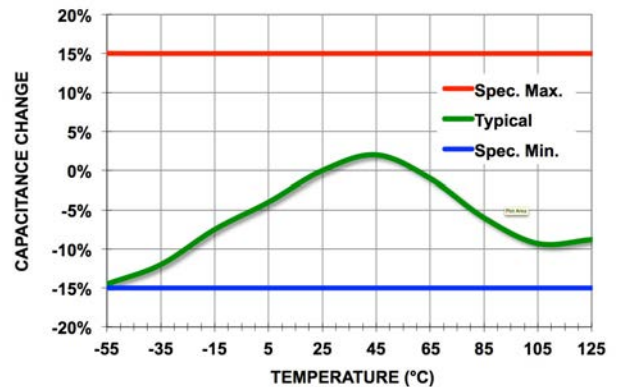

## HOW TO ORDER - BME MINI SWITCH-MODE®

Part number written: 500P07W106MJ4U+RC

500	P07	W	106	M	J	4	U	+RC
VOLTAGE	SIZE	DIELECTRIC	CAPACITANCE	TOLERANCE	TERMINATION	MARKING	PACKING	ROHS CODE
500 = 50 V 101 = 100 V	See Chart	W = X7R	1st two digits are significant; third digit denotes number of zeros. 225 = 2.2 μF 106 = 10 μF	M = ±20%	J = "J" Leads (formed in)	4 = Unmarked	U = Embossed Tape 13" Reel per EIA RS481	+RC = RoHS Compliant



# SWITCH-MODE RADIAL LEADED CAPACITORS

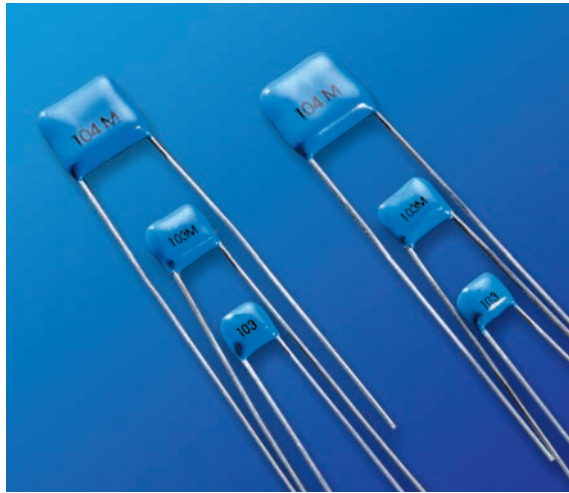





## KEY FEATURES

- Rated Working Voltages from 25 to 500 VDC
- Rugged Epoxy Coating Offers Increased Protection
- Hi-Rel Screened Versions Available
- Custom Sizes, Voltages, and Values Available

## ADVANTAGES





- Power Supplies
- Voltage Multipliers
- Data Isolation
- Surge Protection
- Industrial Control Circuits
- Custom Applications

## CASE SIZE

		IN.	(MM)	RATED VOLTAGE	NP0 CAPACITANCE (MAX.)		X7R CAPACITANCE (MAX.)	
					VALUE	CODE	VALUE	CODE
 <b>H03</b>	W	.300 max.	(7.62 max.)	<b>25 VDC</b>	.070 $\mu$ F	703	2.00 $\mu$ F	205
	H	.300 max.	(7.62 max.)	<b>50 VDC</b>	.060 $\mu$ F	603	1.60 $\mu$ F	165
	T	.200 max.	(5.08 max.)	<b>100 VDC</b>	.050 $\mu$ F	503	1.10 $\mu$ F	115
	S	.200 nom.	(5.08 nom.)	<b>200 VDC</b>	.040 $\mu$ F	403	.730 $\mu$ F	734
	LD	.020 nom.	(.510 nom.)	<b>500 VDC</b>	.020 $\mu$ F	203	.250 $\mu$ F	254
					<b>25 VDC</b>	.120 $\mu$ F	124	5.10 $\mu$ F
 <b>H04</b>	W	.400 max.	(10.2 max.)	<b>50 VDC</b>	.100 $\mu$ F	104	4.10 $\mu$ F	415
	H	.400 max.	(10.2 max.)	<b>100 VDC</b>	.082 $\mu$ F	823	2.70 $\mu$ F	275
	T	.200 max.	(5.08 max.)	<b>200 VDC</b>	.050 $\mu$ F	503	1.80 $\mu$ F	185
	S	.200 nom.	(5.08 nom.)	<b>500 VDC</b>	.030 $\mu$ F	303	.670 $\mu$ F	674
	LD	.020 nom.	(.510 nom.)					
					<b>25 VDC</b>	.240 $\mu$ F	244	8.70 $\mu$ F
 <b>H05</b>	W	.500 max.	(12.7 max.)	<b>50 VDC</b>	.200 $\mu$ F	204	7.20 $\mu$ F	725
	H	.500 max.	(12.7 max.)	<b>100 VDC</b>	.180 $\mu$ F	184	4.80 $\mu$ F	485
	T	.200 max.	(5.08 max.)	<b>200 VDC</b>	.110 $\mu$ F	114	3.30 $\mu$ F	335
	S	.400 nom.	(10.2 nom.)	<b>500 VDC</b>	.070 $\mu$ F	703	1.10 $\mu$ F	115
	LD	.025 nom.	(.635 nom.)					
					<b>25 VDC</b>	.750 $\mu$ F	754	22.0 $\mu$ F
 <b>H06</b>	W	.870 max.	(22.1 max.)	<b>50 VDC</b>	.620 $\mu$ F	624	17.0 $\mu$ F	176
	H	.600 max.	(15.2 max.)	<b>100 VDC</b>	.560 $\mu$ F	564	13.0 $\mu$ F	136
	T	.200 max.	(5.08 max.)	<b>200 VDC</b>	.360 $\mu$ F	364	8.00 $\mu$ F	805
	S	.790 nom.	(20.1 nom.)	<b>500 VDC</b>	.240 $\mu$ F	244	2.90 $\mu$ F	295
	LD	.032 nom.	(.813 nom.)					

See page 81 for additional dielectric specifications.

# SWITCH-MODE RADIAL LEADED CAPACITORS

CASE SIZE		IN.	(MM)	RATED VOLTAGE	NP0 CAPACITANCE (MAX.)		X7R CAPACITANCE (MAX.)	
					VALUE	CODE	VALUE	CODE
 H07	W	1.10 max.	(27.9 max.)	25 VDC	.680 µF	684	35.0 µF	356
	H	.600 max.	(15.2 max.)	50 VDC	.560 µF	564	28.0 µF	286
	T	.200 max.	(5.08 max.)	100 VDC	.470 µF	474	19.0 µF	196
	S	.980 nom.	(24.9 nom.)	200 VDC	.330 µF	334	13.0 µF	136
	LD	.032 nom.	(.813 nom.)	500 VDC	.200 µF	204	4.60 µF	465
					25 VDC	1.20 µF	125	70.0 µF
 H08	W	1.10 max.	(27.9 max.)	50 VDC	1.10 µF	115	56.0 µF	566
	H	.600 max.	(15.2 max.)	100 VDC	.820 µF	824	37.0 µF	376
	T	.350 max.	(8.89 max.)	200 VDC	.470 µF	474	26.0 µF	266
	S	.980 nom.	(24.9 nom.)	500 VDC	.300 µF	304	8.70 µF	875
	LD	.032 nom.	(.813 nom.)					
					25 VDC	.450 µF	454	13.0 µF
 H09	W	.670 max.	(17 max.)	50 VDC	.360 µF	364	10.0 µF	106
	H	.540 max.	(13.7 max.)	100 VDC	.330 µF	334	7.20 µF	725
	T	.200 max.	(5.08 max.)	200 VDC	.240 µF	244	5.00 µF	505
	S	.575 nom.	(14.6 nom.)	500 VDC	.180 µF	184	1.70 µF	175
	LD	.025 nom.	(.635 nom.)					
					25 VDC	1.00 µF	105	38.0 µF
 H10	W	.930 max.	(23.6 max.)	50 VDC	.900 µF	904	30.0 µF	306
	H	.720 max.	(18.3 max.)	100 VDC	.750 µF	754	20.0 µF	206
	T	.250 max.	(6.35 max.)	200 VDC	.470 µF	474	14.0 µF	146
	S	.800 nom.	(20.3 nom.)	500 VDC	.300 µF	304	5.80 µF	585
	LD	.032 nom.	(.813 nom.)					

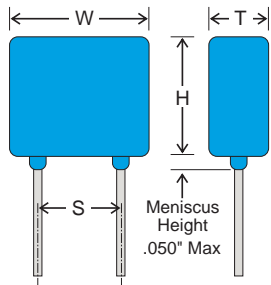

NOTE: Lead lengths are typically 1.25" for orders in bulk packaging. Leads are typically 1.00" for tape and reel packaging. Tape and reel packaging comes in 1000 piece reels.

## HOW TO ORDER SWITCH-MODE RADIALS

Part number written: 201H07W105KQ4

201	H07	W	105	K	Q	4	T
<b>VOLTAGE</b>	<b>SIZE</b>	<b>DIELECTRIC</b>	<b>CAPACITANCE</b>	<b>TOLERANCE</b>	<b>TERMINATION</b>	<b>MARKING</b>	<b>PACKING</b>
250 = 25 V 500 = 50 V 101 = 100 V 201 = 200 V 501 = 500 V	See Chart	N = NP0 W = X7R	1st two digits are significant; third digit denotes number of zeros. 101 = 100 pF 102 = 1000 pF 103 = 0.01 µF 105 = 1.00 µF	J = ± 5% K = ± 10% M = ± 20% Z = +80% -20%	Q = Leaded & Encapsulated	4 = Standard 3 = Specified	T = Tape and Reel H = High Rel Testing per customer requirements S = Special Part



# HIGH VOLTAGE RADIAL LEADED CAPACITORS

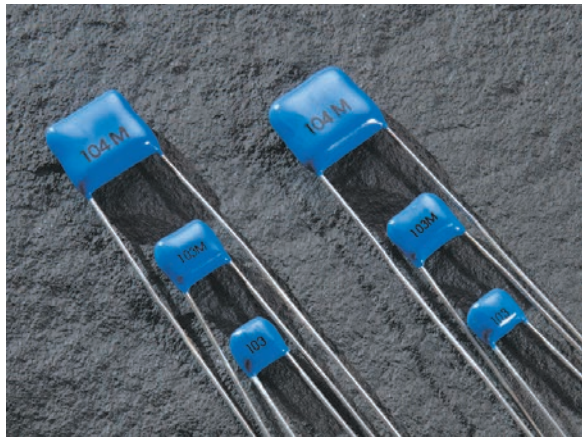





## KEY FEATURES

- Rated Working Voltages from 500 to 5000 VDC
- Rugged Epoxy Coating Offers Increased Protection
- Compact MLC Designs Smaller Than Film or Disc
- NEW 200°C Versions Available for Oil & Geophysical Tool, Aircraft Engine Control Applications
- DSCC Drawing & Other Screened Versions Available

## ADVANTAGES



- Power Supplies
- Voltage Multipliers
- Data Isolation
- Surge Protection
- Industrial Control Circuits
- Custom Applications

## CASE SIZE

		IN.	(MM)	RATED VOLTAGE	NP0 CAPACITANCE (MAX.)		X7R CAPACITANCE (MAX.)	
					VALUE	CODE	VALUE	CODE
 <b>H42</b>	W	0.250 Max	(6.35 Max)	<b>500 VDC</b>	4700 pF	472	.150 µF	154
	H	0.220 Max	(5.59 Max)	<b>1000 VDC</b>	1500 pF	152	.055 µF	553
	T	0.270 Max	(6.86 Max)	<b>2000 VDC</b>	680 pF	681	9000 pF	902
	S	0.170 ±0.03	(4.32 ±0.76)	<b>3000 VDC</b>	330 pF	331	2800 pF	282
	LD	0.025 ±.002	(0.64 ±0.05)	<b>4000 VDC</b>	150 pF	151	630 pF	631
					<b>5000 VDC</b>	100 pF	101	550 pF
 <b>H47</b>	W	0.370 Max	(9.40 Max)	<b>500 VDC</b>	.022 µF	223	.480 µF	484
	H	0.300 Max	(7.62 Max)	<b>1000 VDC</b>	3300 pF	332	.170 µF	174
	T	0.270 Max	(6.86 Max)	<b>2000 VDC</b>	1500 pF	152	.025 µF	253
	S	0.275 ±0.03	(6.99 ±0.76)	<b>3000 VDC</b>	680 pF	681	.011 µF	113
	LD	0.025 ±.002	(0.64 ±0.05)	<b>4000 VDC</b>	330 pF	331	1800 pF	182
					<b>5000 VDC</b>	220 pF	221	940 pF
 <b>H51</b>	W	0.470 Max	(12.0 Max)	<b>500 VDC</b>	.056 µF	563	1.20 µF	125
	H	0.400 Max	(10.2 Max)	<b>1000 VDC</b>	4700 pF	472	.450 µF	454
	T	0.320 Max	(8.13 Max)	<b>2000 VDC</b>	3300 pF	332	.094 µF	943
	S	0.375 ±0.03	(9.53 ±0.76)	<b>3000 VDC</b>	1500 pF	152	.043 µF	433
	LD	0.025 ±.002	(0.64 ±0.05)	<b>4000 VDC</b>	1000 pF	102	.010 µF	103
					<b>5000 VDC</b>	470 pF	471	4900 pF
 <b>H62</b>	W	0.570 Max	(14.5 Max)	<b>500 VDC</b>	.100 µF	104	2.20 µF	225
	H	0.500 Max	(12.7 Max)	<b>1000 VDC</b>	.010 µF	103	.804 µF	804
	T	0.320 Max	(8.13 Max)	<b>2000 VDC</b>	6800 pF	682	.240 µF	244
	S	0.475 ±0.03	(12.1 ±0.76)	<b>3000 VDC</b>	3300 pF	332	.073 µF	733
	LD	0.025 ±.002	(0.64 ±0.05)	<b>4000 VDC</b>	2200 pF	222	.028 µF	283
					<b>5000 VDC</b>	1000 pF	102	.013 µF
 <b>H66</b>	W	0.670 Max	(17.0 Max)	<b>500 VDC</b>	.150 µF	154	3.30 µF	335
	H	0.600 Max	(15.2 Max)	<b>1000 VDC</b>	.015 µF	153	1.20 µF	125
	T	0.320 Max	(8.13 Max)	<b>2000 VDC</b>	.010 µF	103	.440 µF	444
	S	0.575 ±0.03	(14.6 ±0.76)	<b>3000 VDC</b>	4700 pF	472	0.130 µF	134
	LD	0.025 ±.002	(0.64 ±0.05)	<b>4000 VDC</b>	3300 pF	332	.041 µF	413
					<b>5000 VDC</b>	2200 pF	222	.020 µF

See page 79 for additional dielectric specifications.

# HIGH VOLTAGE RADIAL LEADED CAPACITORS

CASE SIZE			RATED VOLTAGE	NP0 CAPACITANCE (MAX.)		X7R CAPACITANCE (MAX.)	
				VALUE	CODE	VALUE	CODE
 H70	W 0.770 Max (19.6 Max) H 0.720 Max (18.3 Max) T 0.320 Max (8.13 Max) S 0.675 ±0.03 (17.1 ±0.76) LD 0.025 ±.002 (0.64 ±0.05)	IN. (MM)	500 VDC	.220 µF	224	5.70 µF	575
			1000 VDC	.022 µF	223	2.10 µF	215
			2000 VDC	.015 µF	153	.620 µF	624
			3000 VDC	6800 pF	682	.190 µF	194
			4000 VDC	4700 pF	472	.054 µF	543
			5000 VDC	3300 pF	332	.026 µF	263
 H72	W 0.870 Max (22.1 Max) H 0.750 Max (19.1 Max) T 0.320 Max (8.13 Max) S 0.675 ±0.03 (19.7 ±0.76) LD 0.025 ±.002 (0.64 ±0.05)	IN. (MM)	500 VDC	.330 µF	334	7.30 µF	735
			1000 VDC	.100 µF	104	2.80 µF	285
			2000 VDC	.056 µF	563	.800 µF	804
			3000 VDC	.033 µF	333	.250 µF	254
			4000 VDC	.010 µF	103	.080 µF	803
			5000 VDC	6800 pF	682	.041 µF	413
 H80	W 1.450 Max (36.8 Max) H 0.720 Max (18.3 Max) T 0.320 Max (8.13 Max) S 1.375 ±0.03 (34.9 ±0.76) LD 0.025 ±.002 (.064 ±0.05)	IN. (MM)	500 VDC	.470 µF	474	12.0 µF	126
			1000 VDC	.150 µF	154	4.60 µF	465
			2000 VDC	.082 µF	823	1.20 µF	125
			3000 VDC	.047 µF	473	.390 µF	394
			4000 VDC	.015 µF	153	.130 µF	134
			5000 VDC	.010 µF	103	.068 µF	683

## T-SERIES 200°C

Johanson also offers two different series of high temperature radial leaded capacitors for 200°C. These components feature rugged premolded cases with Hi-Temp epoxy fill. The 200°C line is offered in voltage ratings of 25V to 4KV and maximum capacitance loss of -0.5% in NP0 and -45% in X7R. The line is offered in voltage ratings of 50V & 100V with maximum capacitance loss of -1.5% in NP0 and -55% in X7R. Please visit our website for complete component selection & specifications

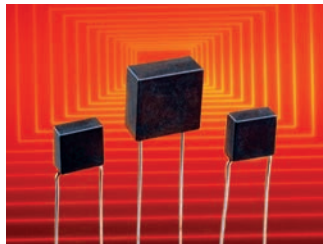

### APPLICATIONS

- Oil Well Logging (Downhole)
- Geophysical Probes
- Jet Engine Controls

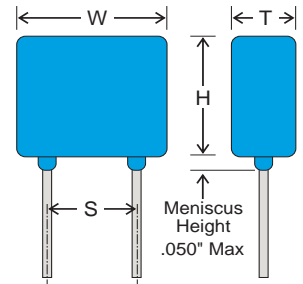

NOTE: Lead lengths are typically 1.25" for orders in bulk packaging. Leads are typically 1.00" for tape and reel packaging. Tape and reel packaging comes in 1000 piece reels.

## HOW TO ORDER HIGH VOLTAGE RADIALS

Part number written: 102H42W101KQ4 T

102	H42	W	101	K	Q	4	T
VOLTAGE	SIZE	DIELECTRIC	CAPACITANCE	TOLERANCE	TERMINATION	MARKING	PACKING
501 = 500 V 102 = 1000 V 202 = 2000 V 302 = 3000 V 402 = 4000 V 502 = 5000 V	See Chart	N = NP0 W = X7R	1st two digits are significant; third digit denotes number of zeros. 102 = 1000 pF 103 = 0.01 µF 105 = 1.00 µF	J = ± 5% K = ± 10% M = ± 20% Z = +80% -20%	Q = Leaded & Encapsulated	4 = Standard 3 = Specified	T = Tape and Reel H = High Rel Testing per customer requirements S = Special Part



# PLANAR CAPACITOR ARRAYS FOR EMI FILTERING

Johanson Dielectrics is the premier supplier of Planar Capacitor EMI Filter Arrays to the Filtered Connector Industry. Johanson filters exhibit excellent RF performance, as well as high SRF's (Series Resonant Frequency). Planar Capacitors are the fundamental building block for filtered connectors in Aerospace, Biomedical, Military, Satellite, Industrial and Communication electronics.

Johanson offers NP0, X7R and MOV (Metal Oxide Varistor) Planar Arrays in standard and custom solutions to fit your needs (1 to 150 pins).

MOV planar arrays can be used singularly to form low pass C filters with the additional benefit of transient voltage protection. When combined together with planar array capacitors, they can form balanced and unbalanced Pi filters with transient voltage protection. The MOV technology enables smaller connectors to be built when compared to other discrete voltage protection component solutions, such as diodes.

We are eager to quote your custom requirements and unique products, in addition to your commercial or Mil-Standard needs.

Each Johanson part is customized to meet specific customer needs.

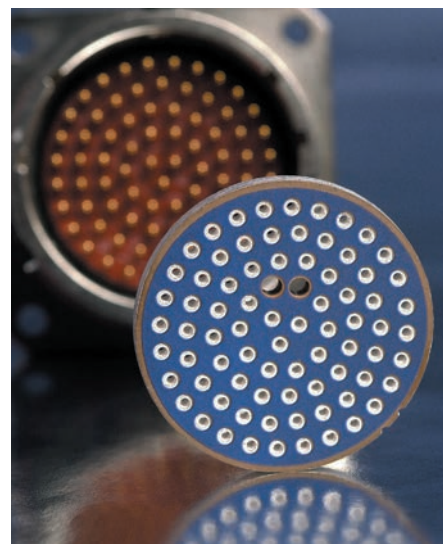

## CIRCULAR ARRAYS

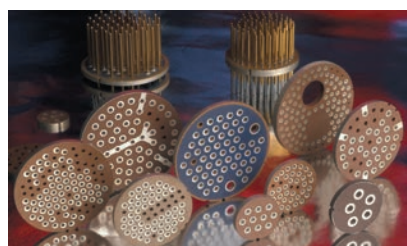

EXAMPLE PHYSICAL LAYOUT	DIELECTRIC MATERIAL	AVAILABLE CAPACITANCE	WORKING VOLTAGE	DWV VOLTAGE
MIL-1560 MIL-1554 MIL-1669 MIL-1651 MIL-1698 MIL-33702 MIL-AUDIO	X7R, NP0 & Selected MOV	47 pF to 1000 nF	Up to 2,000 VDC	Up to 2,500V VDC

## RECTANGULAR ARRAYS (ARINC 404/600)

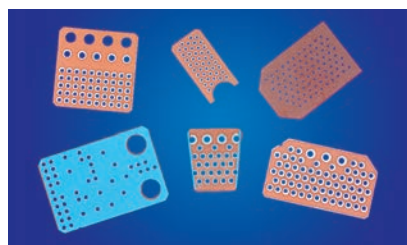

EXAMPLE PHYSICAL LAYOUT	DIELECTRIC MATERIAL	AVAILABLE CAPACITANCE	WORKING VOLTAGE	DWV VOLTAGE
AR-010 Through AR-150	X7R, NP0 & Selected MOV	47 pF to 1000 nF	Up to 2,000 VDC	Up to 2,500V VDC

## D-SUBMINATURE RECTANGULAR ARRAYS

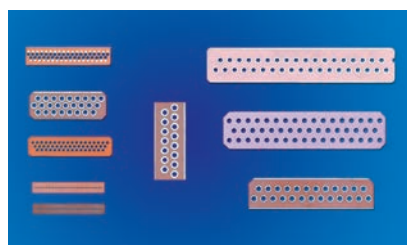

EXAMPLE PHYSICAL LAYOUT	DIELECTRIC MATERIAL	AVAILABLE CAPACITANCE	WORKING VOLTAGE	DWV VOLTAGE
Full Size	X7R, NP0 & Selected MOV	47pF - 210nF	≤ 2,400	≤ 3,600
Mini-D		47pF - 100nF	≤ 1,000	≤ 1,500
Micro-D		47pF - 22.5nF	≤ 680	≤ 1,020
Nano-D		47pF - 3.0nF	≤ 200	≤ 500
Combo-D		47pF - 6.0nF	≤ 800	≤ 1,200
Power-D		47pF - 120nF	≤ 680	≤ 1,020
Special		47pF - 50nF	≤ 300	≤ 750



# PLANAR CAPACITOR ARRAYS FOR EMI FILTERING

## CUSTOM ARRAYS

Johanson Dielectrics's design expertise and CNC manufacturing process enable broad custom array capability. Many shapes, configurations and geometries are possible. Share your requirements and we will create a solution!

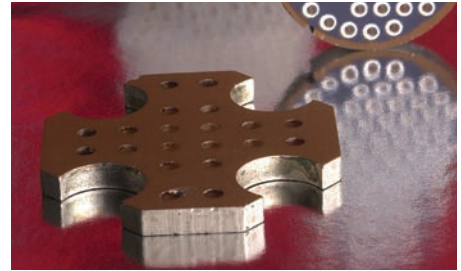

## DISCOIDAL CAPACITORS

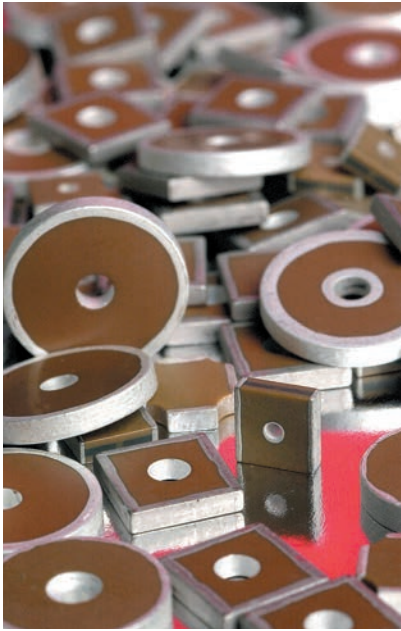

Johanson Discoidal Feed-through Capacitors are the functional element in widely used EMI feed-through filters. This capacitor configuration offers very low impedance and inductance. Discoidal capacitors are ideal for by-pass, filtering, coupling, single line EMI/RFI suppression, and high frequency applications.

- Capacitance values from 10 pF to 11.2  $\mu$ F
- Test standards and procedures per MIL-STD-202 and MIL-C-123
- Voltage ratings from 50 to 3000 VDC and 50 to 240 VAC
- Low ESR and ESL, non-polar designs

Call us to discuss your special requirements!

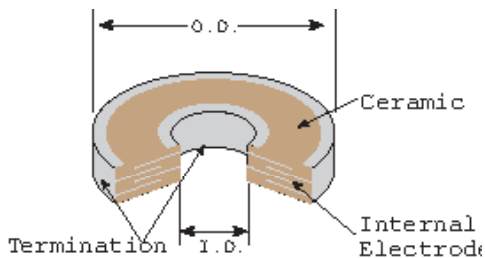

EXAMPLE NOMINAL O.D. (IN.)	DIELECTRIC MATERIAL	AVAILABLE CAPACITANCE	INSIDE DIAMETER (IN.)	THICKNESS (IN.)	RATED VOLTAGE
0.100 $\pm$ .005	X7R, NPO & Selected MOV	10 pF – 66 nF	0.025 $\pm$ 0.048	0.025 $\pm$ 0.070	Up to 200 VDC
0.150 $\pm$ .005		10 pF – 200 nF	0.037 $\pm$ 0.058	0.025 $\pm$ 0.070	Up to 200 VDC
0.335 $\pm$ .005		10 pF – 2.8 $\mu$ F	0.034 $\pm$ 0.088	0.040 $\pm$ 0.110	Up to 500 VDC
0.345 $\pm$ .005		10 pF – 6.0 $\mu$ F	0.040 $\pm$ 0.085	0.055 $\pm$ 0.110	Up to 750 VDC
0.376 $\pm$ .005		10 pF – 8.0 $\mu$ F	0.050 $\pm$ 0.075	0.065 $\pm$ 0.125	Up to 750 VDC
0.643 $\pm$ .005		10 pF – 15 $\mu$ F	0.063 $\pm$ 0.080	0.055 $\pm$ 0.150	Up to 750 VDC
0.840 $\pm$ .005		10 pF – 20 $\mu$ F	0.050 $\pm$ 0.075	0.080 $\pm$ 0.130	Up to 1000 VDC

# CAPSTRATE® CAPACITOR SUBSTRATES

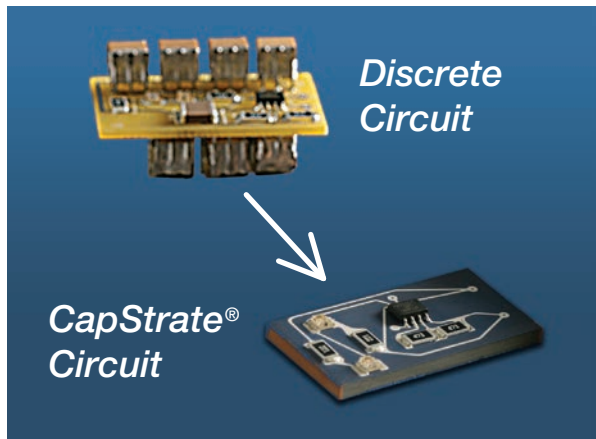

Johanson CapStrate® products integrate bulk capacitance into a ceramic substrate eliminating large discrete capacitive components which saves critical space and simplifies the assembly process. Our design and manufacturing expertise in large format, custom geometries provides innovative solutions that economically solve a wide variety of your design challenges.

## ADVANTAGES

- Major Size & Weight Reduction
- Fewer Solder Joints
- Lower Assembly Cost
- Circuit Assembly Available

## KEY FEATURES

- Integrated Capacitance in The Substrate
- Rated Working Voltages from 50V to 5,000V
- Temperature ranges: -55°C to 125°C (specials to 200°C and 250°C)
- Compact Designs Utilizing Military Grade Ceramics
- Custom Sizes, Values, and Voltages Available

## SIZE / CAPACITANCE CAPABILITY EXAMPLES

SUBSTRATE SIZE		LENGTH	WIDTH	THICK	NP0 50V	NP0 100V	NP0 200V	NP0 500V	X7R 50V	X7R 100V	X7R 200V	X7R 500V
CapStrate 4	In	0.400	0.400	0.120	0.22µF	0.15µF	0.12µF	0.07µF	9.0µF	6.0µF	3.0µF	1.5µF
	mm	10.2	10.2	3.1								
CapStrate 3	In	0.450	1.00	0.120	0.70µF	0.50µF	0.39µF	0.22µF	28.0µF	20.0µF	9.0µF	4.7µF
	mm	11.43	25.4	3.1								
CapStrate 1	In	0.450	2.00	0.120	1.40µF	1.00µF	0.75µF	0.44µF	50.0µF	40.0µF	18.0µF	9.4µF
	mm	11.4	50.8	3.1								
CapStrate 2	In	0.800	1.50	0.120	2.00µF	1.40µF	1.00µF	0.60µF	75.0µF	55.0µF	25.0µF	14.0µF
	mm	20.3	38.1	3.1								
CapStrate 6	In	1.250	2.00	0.120	4.00µF	2.80µF	2.00µF	1.20µF	150.0µF	110.0µF	50.0µF	28.0µF
	mm	31.8	50.8	3.1								
Circular CapStrate® Capacitance Formula					1.3 -1.6 µF / In <sup>2</sup>	0.9 -1.1 µF / In <sup>2</sup>	0.7 -0.8 µF / In <sup>2</sup>	50 - 62 µF / In <sup>2</sup>	35 - 45 µF / In <sup>2</sup>	18 - 20 µF / In <sup>2</sup>	1.3 -1.6 µF / In <sup>2</sup>	9 -10 µF / In <sup>2</sup>

This chart is intended to provide capability examples. Not all possibilities are shown and we invite application specific inquiries. Circular CapStrate® example lists available capacitance per area.



# CUSTOM CAPACITOR SOLUTIONS

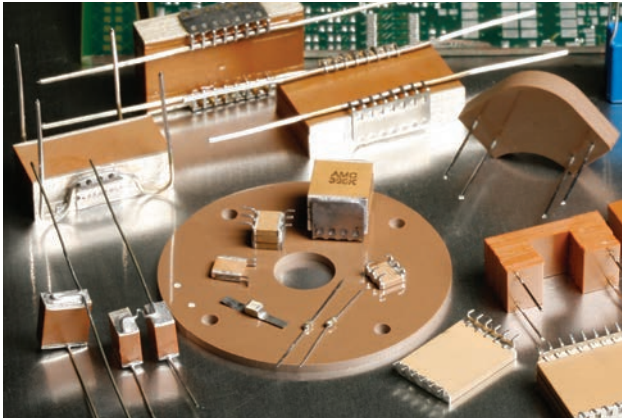

Johanson's extensive experience in design and manufacture of large format, custom geometries allows us to develop unique and innovative solutions which successfully solve a wide variety of our customer's design challenges. We'll work pro actively with you to fully understand your requirements and recommend the best solution possible.

## KEY FEATURES

---

- Custom shapes to fit specific requirements
- Multiple capacitors in a single assembly
- NP0/COG and X7R solutions from -55°C to +125°C
- Multiple pin, lead-frame, and flying wire options
- Bare ceramic, epoxy coated, potted solutions

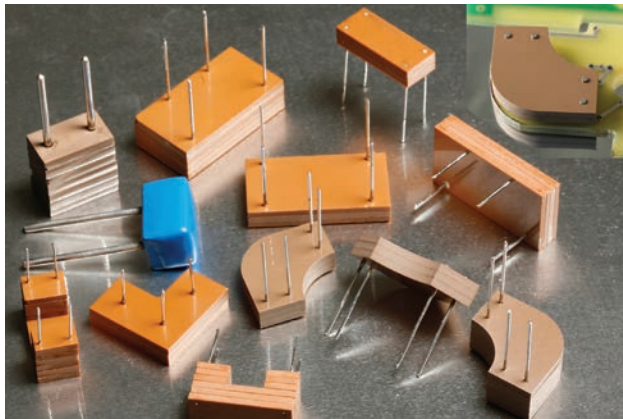
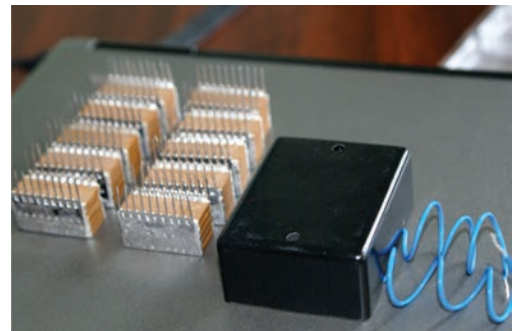

## VARIABLE PITCH ASSEMBLIES

---

Another custom approach is our variable pitch design. No longer are you limited to a vendor's standard catalogue offering or only square or rectangular custom designs. We let you become your own capacitor designer by not only telling us the desired capacitance and voltage, but also the size, shape, and location of leads! This process helps insure that the resulting capacitor satisfies every aspect of your design requirements.

## ON-LINE PRODUCTS

---

200°C Radial Leaded Capacitors  
Large Size MLC Capacitors  
High Power AC Capacitors

# CAPACITOR GENERAL ELECTRICAL CHARACTERISTICS & PN BREAKDOWN

## ELECTRICAL CHARACTERISTICS

PARAMETER	NP0		X7R		X5R	
TEMPERATURE COEFFICIENT:	0 ± 30 ppm/°C	-55 to +125°C	± 15%	-55 to +125°C	± 15%	-55 to +85°C
DISSIPATION FACTOR:	.001 (0.1%) max		WVDC ≥ 50 VDC, DF = 2.5% max WVDC = 25 VDC, DF = 3.0% max WVDC = 16 VDC, DF = 3.5% max		For Vrated ≥ 50 VDC, DF = 5% max For Vrated ≤ 25 VDC: DF = 10% max	
AGING:	None		2.5% / decade hour		2.5% / decade hour	
INSULATION RESISTANCE:	1000ΩF or 100GΩ whichever is less @ 25°C, WVDC		500ΩF or 50GΩ whichever is less @ 25°C, WVDC		100ΩF or 10GΩ whichever is less @ 25°C, WVDC	
DIELECTRIC STRENGTH:	For Vrated = 6 - 200 VDC, DWV = 2.5 X WVDC, 25°C, 50mA max. For Vrated = 201 - 499 VDC, DWV = 2.0 X WVDC, 25°C, 50mA max. For Vrated = 500 - 999 VDC, DWV = 1.5 X WVDC, 25°C, 50mA max. For Vrated = 1000+ VDC, DWV = 1.2 X WVDC, 25°C, 50mA max.				DWV = 2.5 X WVDC, 25°C, 50mA max.	
TEST PARAMETERS:	C > 100 pF; 1kHz ±50Hz; 1.0±0.2 VRMS C ≤ 100 pF 1Mhz ±50kHz; 1.0±0.2 VRMS		Capacitance values ≤ 10 μF: 1.0kHz±50Hz @ 1.0±0.2 Vrms  Capacitance values > 10 μF: 120Hz±10Hz @ 0.5V±0.1 Vrms		Capacitance values ≤ 10 μF: 1.0kHz±50Hz @ 1.0±0.2 Vrms  Capacitance values > 10 μF: 120Hz±10Hz @ 0.5V±0.1 Vrms	
NOTES:	Tanceram IR = 100 ΩF or 10 GΩ Tanceram DF for Vrated ≥ 50 VDC = 5% max. Tanceram DF for Vrated ≤ 25 VDC, DF = 10% max					

## PART NUMBER BREAKDOWN - SURFACE MOUNT

Part number written: 502R29W102KV3E-\*\*\*\*-SC

502	R 29	W	102	K	V	3	E
VOLTAGE	SERIES/SIZE	DIELECTRIC	CAPACITANCE	TOLERANCE	TERMINATION	MARKING	PACKING
6R3 = 6.3 V DC 10 = 10 V DC 16 = 16 V DC 25 = 25 V DC 50 = 50 V DC 101 = 100 V DC 201 = 200 V DC 251 = 250 V DC 301 = 300 V DC 501 = 500 V DC 631 = 630 V DC 102 = 1000 V DC 202 = 2000 V DC 302 = 3000 V DC* 402 = 4000 V DC 502 = 5000 V DC* ACJ = 250 VAC * For Safety Caps with -****-SC P/N suffix only: 302 = 250VAC [2500V Impulse] 502 = 250VAC [5000V Impulse]	A__ = ARRAY B__ = LICC F__ = F-T FILTER R__ = MLCC S__ = MLCC T__ = HI TEMP MLCC X__ = X2Y  __05=0201 __07=0402 __14=0603 __15=0805 __18=1206 __41=1210 __29=1808 __30=2211 __43=1812 __44=1410 __47=2220 __49=1825 __48=2225	N = NP0 W = X7R X = X5R	1st two digits are significant; third digit denotes number of zeros, R = decimal.  5R6 = 5.6 pF 100 = 10 pF 102 = 1,000 pF 474 = 0.47 μF 475 = 4.7 μF 106 = 10 μF	* B = ± 0.10 pF * C = ± 0.25 pF * D = ± 0.50 pF F = ± 1% G = ± 2% J = ± 5% K = ± 10% M = ± 20% Y = +50 -20% Z = +80 -20%  *Values < 10 pF only	V = Nickel Barrier with 100% Tin Plating (Matte)  F = Polyterm flexible termination G = Gold T = SnPb P = PdAg	3 = Special 4 = Unmarked 6 = EIA Code*  *Not available on sizes ≤ 0402	E = Embossed 7" T = Punched 7" U = Embossed 13" R = Punched 13"  No code = bulk pack  Tape specifications conform to EIA RS481  Not all tape styles are available on all parts.
<b>****-SC</b>							<b>SC</b>
<b>PART NUMBER MODIFIER</b>							
Used on select parts such as Safety Certified or for customer specific requirements.							

**PLEASE NOTE:** Not all combinations of JDI P/Ns are valid. Please refer to the "How to Order" detail section of the specific product or contact your Sales Representative if you need assistance.



# CAPACITOR PACKAGING

Johanson capacitors are available taped per EIA standard 481. Tape options include 7" and 13" diameter reels. Johanson uses high quality, dust free, punched 8mm paper tape and plastic embossed 8mm tape for thicker MLCCs. Quantity per reel ranges are listed in the tables below and are dependent on chip thickness.

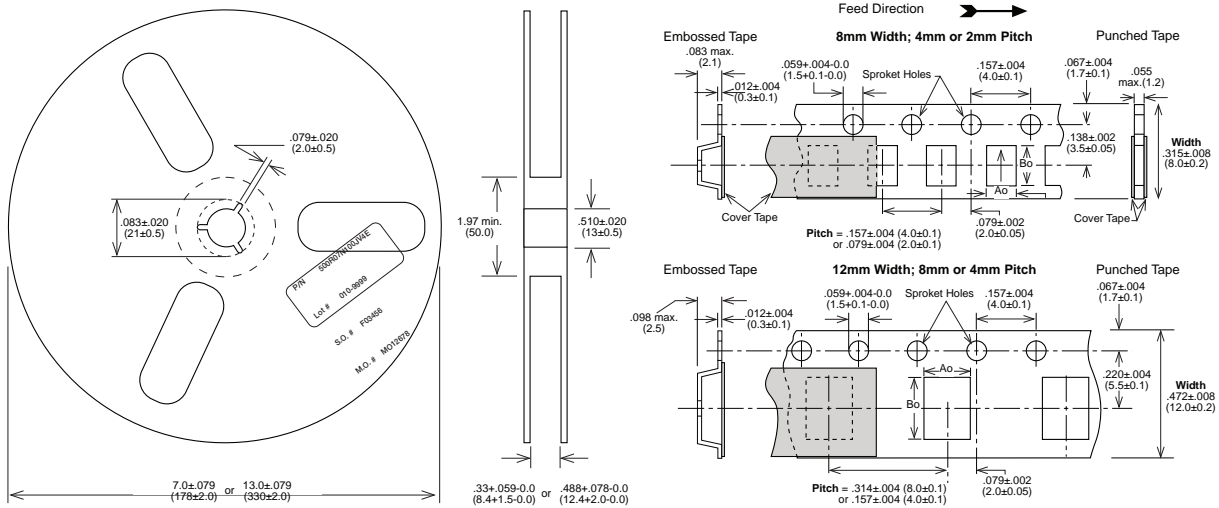
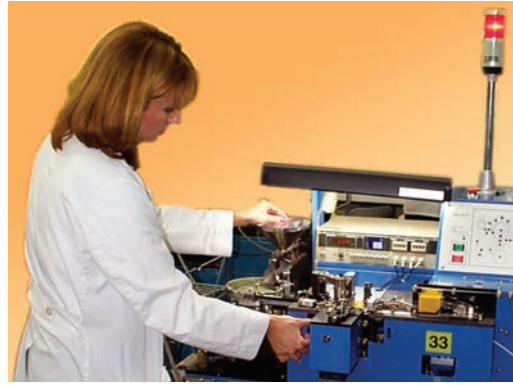

COMPONENT	7" DIAMETER REEL				13" DIAMETER REEL			
	REEL QTY	TAPE TYPE	WIDTH / PITCH	CODE	REEL QTY	TAPE TYPE	WIDTH / PITCH	CODE
R05 / 0201 MLCC	15000	Paper	8mm/2mm	T	N/A	N/A		N/A
R07 / 0402 MLCC	10000	Paper	8mm/2mm	T	N/A	N/A		N/A
R14 / 0603 MLCC	4000	Paper	8mm/4mm	T	10000	Paper	8mm/4mm	R
R15 / 0805 MLCC	4000 / 3000	Paper / Embossed	8mm/4mm	T / E	10000	Paper / Embossed	8mm/4mm	R / U
R18 / 1206 MLCC	4000 / 3000	Paper / Embossed	8mm/4mm	T / E	10000	Paper / Embossed	8mm/4mm	R / U
S41 / 1210 MLCC	2000 - 4000	Embossed	8mm/4mm	E	5000-10000	Embossed	8mm/4mm	U
R29 / 1808 MLCC	2000	Embossed	12mm/4mm	E	5000 - 8000	Embossed	12mm/4mm	U
R30 / 2211 MLCC	1000 - 2000	Embossed	12mm/4mm	E	2000 - 5000	Embossed	12mm/4mm	U
S43 / 1812 MLCC	500 - 1000	Embossed	12mm/8mm	E	3000 - 5000	Embossed	12mm/8mm	U
S47 / 2220 MLCC	250 - 1000	Embossed	12mm/8mm	E	2000 - 5000	Embossed	12mm/8mm	U
S49 / 1825 MLCC	250 - 1000	Embossed	12mm/8mm	E	2000 - 4000	Embossed	12mm/8mm	U
S48 / 2225 MLCC	250 - 1000	Embossed	12mm/8mm	E	2000 - 4000	Embossed	12mm/8mm	U
X07 / 0402 X2Y	4000	Paper	8mm/2mm	T	10000	Paper	8mm/2mm	R
X14 / 0603 X2Y	4000	Paper	8mm/4mm	T	10000	Paper	8mm/4mm	R
X15 / 0805 X2Y	4000	Embossed	8mm/4mm	E	10000	Embossed	8mm/4mm	U
X18 / 1206 X2Y	3000 - 4000	Embossed	8mm/4mm	E	10000	Embossed	8mm/4mm	U
X41 / 1210 X2Y	2000 - 3000	Embossed	8mm/4mm	E				
X44 / 1410 X2Y	1000 - 2000	Embossed	8mm/4mm	E				
X43 / 1812 X2Y	1000	Embossed	12mm/8mm	E				

Actual reel quantities based on part thickness and tape type. Contact sales for reel quantities of specific part numbers.

# INDEX OF APPLICATION NOTES AVAILABLE AT JOHANSONDIELECTRICS.COM

## *GENERAL*

---

Ceramic Capacitor Aging Made Simple  
Capacitor Cracks: Still with us after all these years  
Understanding Ceramic Capacitors Termination  
Capacitors Packaging & Marking  
Electrical Characteristics  
MLCC Storage and Handling Conditions

## *APPLICATION NOTES*

---

AC Power Computations for DC Rated Capacitor  
Arc Season and Board Design Observations  
Corona Effects and their Impact on PWB Layout Induced Hipot failures  
DC-DC Converter trends and Output Filter Capacitors  
Impact of Pad design and Spacing on AC Breakdown Performance  
Pb Free Application Notes  
Polyterm® Flexible SMD Termination  
Safety Certified Application Notes  
Sn/Pb SMT Application Notes  
Soldering and Handling Precautions for Large Form Capacitors and Planar Arrays  
Tantalum Replacement MLC's and ESR Curves

## *PROCESSING*

---

Foward/Backward Process Compatability  
Pb Free Application Notes  
Peak Reflow times, Temperature and the Impact of MSL  
Tin Wisker Testing

## *EMI APPLICATION NOTES*

---

Amplifier Decoupling: EMI vs MLCC  
GSM RFI Supression with EMI Filters  
EMI Filter Evaluation and PCB Design Guide  
Improve Instrument Amplifier Performance with EMI optimized input filter  
EMI DC Motor Filtering Basics  
EMI Power Bypass Mounting  
EMI SerDes Bypass Example



# Your Technology Partner



High Voltage

High Capacitance



EMI Filters

AC Safety



High Temperature

AC Power



Planar Arrays &  
Discodials

SMPS &  
Leaded



Custom Solutions



**UNITED STATES:**

HEADQUARTERS  
4001 Calle Tecate,  
Camarillo CA 93012  
TEL (805) 389-1166

<https://www.johansondielectrics.com>

**HONG KONG:**

JOHANSON HONG KONG, LTD.  
Unit 812, Heng Ngai Jewelry Ctr.,  
44 Hok Yuen Street East, Hunghom,  
Kowloon, Hong Kong  
TEL +852 2334 6310

[asiasales@johansondielectrics.com](mailto:asiasales@johansondielectrics.com)

## Looking for pricing, stock, or lifecycle information?

Click below to explore more details on WIN SOURCE:

- ⊖ [View TDCP500W102K1GV001T on WIN SOURCE](#)
- ⊖ [Johanson Dielectrics Inc. Information](#)

## Optimize Your Supply Chain with WIN SOURCE Solutions

- ✓ Global Sourcing Solution
- ✓ Obsolete Management
- ✓ Cost Control Management
- ✓ Shortage Management
- ✓ Alternative Solution
- ✓ Excess Inventory Management