



**THE DATASHEET OF  
TL6120DF500QG**



# TL6120 SERIES TACT SWITCH

ANTI-VANDAL SWITCHES  
 DETECTOR SWITCHES  
 DIP SWITCHES  
 KEYLOCK SWITCHES  
 NAVIGATION SWITCHES  
 PUSHBUTTON SWITCHES  
 ROCKER SWITCHES  
 ROTARY SWITCHES  
 SLIDE SWITCHES  
 SNAP ACTION SWITCHES  
**TACTILE SWITCHES**  
 TOGGLE SWITCHES  
 CAP OPTIONS



## APPLICATIONS / MARKETS

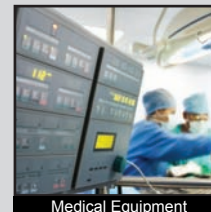
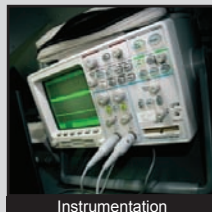
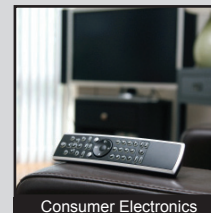
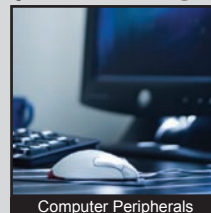
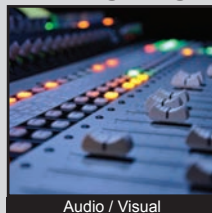

**RoHS**

## SPECIFICATIONS

**Electrical Rating:** 50mA @ 12VDC  
**Life Expectancy:** per chart  
**Contact Resistance:** 100mΩ Max. Initial  
**Insulation Resistance:** 100 MΩ Min. at 100VAC  
**Dielectric Strength:** 250VAC for 1 min.  
**Operating Temperature:** -40°C to 85°C  
**Storage Temperature:** -40°C to 85°C  
**Operating Force:** 130 gf, 160 gf, 300 gf, 500 gf  
**Travel:** 0.50mm  
**Contact Arrangement:** SPST

## FEATURES & BENEFITS

- Tape & Reel packaging
- Multiple operating forces
- Gold or silver contact option
- Multiple actuator lengths
- Process sealed

## PART NUMBER CONFIGURATOR

Series	Actuator Options	Actuation Force	Contact Plating	Termination										
<input type="checkbox"/> <input type="checkbox"/> <input type="checkbox"/> <input type="checkbox"/> <input type="checkbox"/> <input type="checkbox"/> TL6120 - surface mount	<input type="checkbox"/> A - 4.70mm B - 5.20mm C - 6.90mm D - 10.0mm	<input type="checkbox"/> <input type="checkbox"/> <input type="checkbox"/> <input type="checkbox"/> F130 - 130 gf F160 - 160 gf F300 - 300 gf F500 - 500 gf	<input type="checkbox"/> Q - Silver R - Gold	<input type="checkbox"/> G - Gullwing										
		<table border="1"> <thead> <tr> <th>Actuation Force</th> <th>Life Cycles</th> </tr> </thead> <tbody> <tr> <td>130 gf</td> <td>1,000,000</td> </tr> <tr> <td>160 gf</td> <td>1,000,000</td> </tr> <tr> <td>300 gf</td> <td>500,000</td> </tr> <tr> <td>500 gf</td> <td>200,000</td> </tr> </tbody> </table>	Actuation Force	Life Cycles	130 gf	1,000,000	160 gf	1,000,000	300 gf	500,000	500 gf	200,000		
Actuation Force	Life Cycles													
130 gf	1,000,000													
160 gf	1,000,000													
300 gf	500,000													
500 gf	200,000													

*Specifications subject to change without notice*



**E-SWITCH®**

www.e-switch.com

800.867.2717

2

# TL6120 SERIES TACT SWITCH

## BODY DIMENSIONS

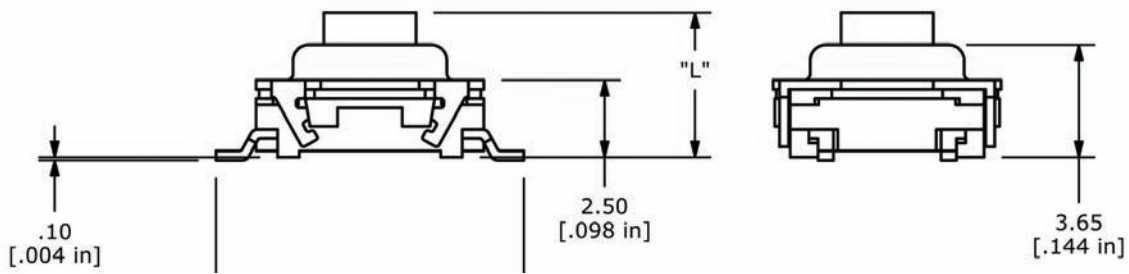
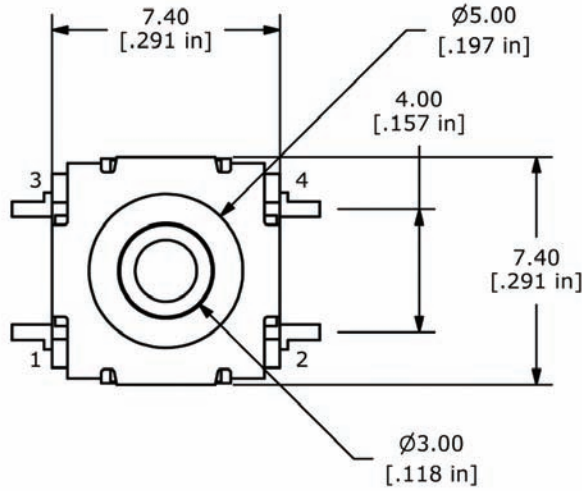

Actuator	"L" Dimension
A	4.70
B	5.20
C	6.90
D	10.00

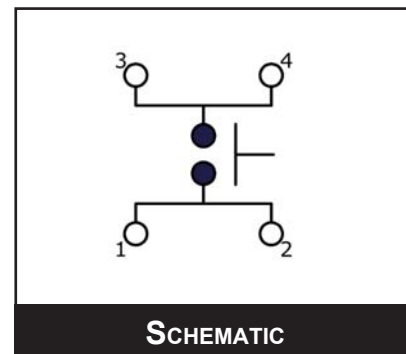
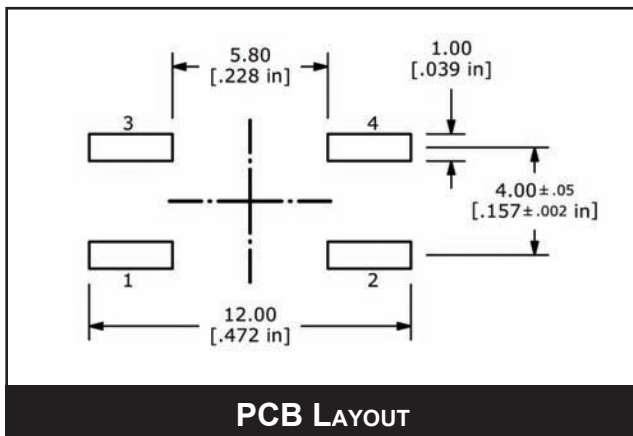

ANTI-VANDAL SWITCHES  
 DETECTOR SWITCHES  
 DIP SWITCHES  
 KEYLOCK SWITCHES  
 NAVIGATION SWITCHES  
 PUSHBUTTON SWITCHES  
 ROCKER SWITCHES  
 ROTARY SWITCHES  
 SLIDE SWITCHES  
 SNAP ACTION SWITCHES  
**TACTILE SWITCHES**  
 TOGGLE SWITCHES  
 CAP OPTIONS



## Looking for pricing, stock, or lifecycle information?

Click below to explore more details on WIN SOURCE:

 [View TL6120DF500QG on WIN SOURCE](#)

 [E-Switch Information](#)

## Optimize Your Supply Chain with WIN SOURCE Solutions

-  Global Sourcing Solution
-  Obsolete Management
-  Cost Control Management
-  Shortage Management
-  Alternative Solution
-  Excess Inventory Management