



**THE DATASHEET OF
ABS06W-32.768KHZ-K-2-T**



32.768KHZ IoT OPTIMIZED SMD CRYSTAL



ABS06W

2.0 x 1.2 x 0.6 mm

RoHS/RoHS II Compliant

MSL = N/A: NOT APPLICABLE

Due to capacity constraints, this product is temporarily unavailable.
 Recommended alternative part number: ABS04W or ABS05W
 Contact Abracon for technical assistance: tech-support@abracon.com

FEATURES

- Exceptionally low plating load of 3.0pF, ideal for wearables, wireless, and IoT applications
- Simultaneously optimized for ESR over extended operating temperature range
- Miniature 2.0x1.2x0.6 mm SMD package, ideally suited for space constrained designs
- Seam sealed package for long term reliability

APPLICATIONS

- Wearables
- Wireless Modules
- Internet of Things (IoT)
- Bluetooth/Bluetooth Low Energy (BLE)
- Machine-to-Machine (M2M) Connectivity
- Ultra Low Power MCU
- Near Field Communication (NFC)
- ISM Band Applications
- Ultra low power, energy saving MCU

STANDARD SPECIFICATIONS

PARAMETERS	MINIMUM	TYPICAL	MAXIMUM	UNITS	NOTES
Frequency	32.768			kHz	
Operation Mode	Flexural Mode (Tuning Fork)				
Operating Temperature	-40		+125	°C	See options
Storage Temperature	-55		+125	°C	
Frequency Tolerance @ +25°C	-20		+20	ppm	Refer to Note #1
Shift through standard RoHS Reflow, (2) reflow cycles maximum	-2.00		+2.00	ppm	260°C peak maximum reflow temperature, relative to stand-alone set-tolerance frequency
Temperature Coefficient:	-0.04	-0.03	-0.02	ppm/T ²	
Turn-over temperature:	+20	+25	+30	°C	
Frequency Stability Over Operating Temperature, relative to in-circuit measured frequency post reflow	-200		-100	ppm	Over -40°C to +85°C
	-275		-100	ppm	Over -40°C to +105°C
	-450		-100	ppm	Over -40°C to +125°C
Load capacitance (CL)	3			pF	Refer to Note #2
Equivalent Series Resistance (ESR)		<55	65	kΩ	@ +25±3°C
		<75	95	kΩ	Over -40°C to +85°C
		<90	110	kΩ	Over -40°C to +105°C
		<100	120	kΩ	Over -40°C to +125°C
Shunt capacitance (C0)		1.0	2.0	pF	Combined Electrode & Package Capacitance
Motional Capacitance (C1)		5.0		fF	C1 also referred as Cm
Motional Inductance (L1)		5,549,000		mH	L1 also referred as Lm
Drive Level		0.1	0.5	μW	
Crystal sensitivity to closed-loop oscillator loading (Ts)	125	140	165	ppm/pF	Refer to Note #3
Q value	10000				Quality Factor
Aging @ +25°C±3°C [First Year]	-3		+3	ppm	Relative to post reflow measured frequency
Aging @ +25°C±3°C [Over 10-years]	-10		+10	ppm	Relative to post reflow measured frequency
Insulation Resistance	500			MΩ	@ 100Vdc

Note #1: With an effective loop capacitance of 3.0pF, the oscillator circuit will be within set-tolerance specification; less any frequency shift due to the reflow process.

Note #2: The oscillator loop needs to present an effective loop capacitance of 3.0 pF to track the stand-alone crystal frequency. This loop capacitance is essential to ensure highest possible Closed-Loop Safety Factor for the entire population of crystals.

Note #3: $T_s = - (C1) / [2*(C0 + CL)^2]$ Where CL = 3pF



5101 Hidden Creek Ln Spicewood TX 78669
 Phone: 512-371-6159 | Fax: 512-351-8858
 For terms and conditions of sales, please visit:
www.abracon.com

REVISED: 05.26.2021

ABRACON IS
 ISO9001-2015
 CERTIFIED

32.768KHZ IoT OPTIMIZED SMD CRYSTAL



ABS06W

2.0 x 1.2 x 0.6 mm

RoHS/RoHS II Compliant

MSL = N/A: NOT APPLICABLE

OPTIONS AND PART IDENTIFICATION

ABS06W - 32.768kHz - ○ - ○ - ○

OPERATING TEMP RANGE	FREQ. TOLERANCE	PACKAGING
D: -40°C ~ +85°C	2: ±20 ppm	Blank: Bulk
J: -40°C ~ +125°C		T: Tape & Reel (3,000pcs/reel)
K: -55°C ~ +125°C		T9: Tape & Reel (9,000pcs/reel)

TYPICAL FREQUENCY TOLERANCE DISTRIBUTION (AT 25°C ± 3°C)

TYPICAL ESR DISTRIBUTION (AT 25°C ± 3°C)

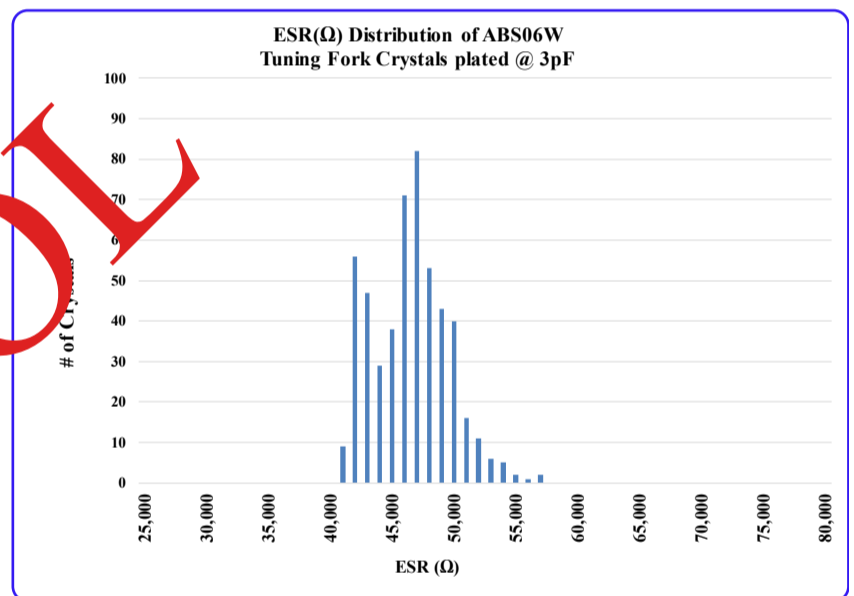
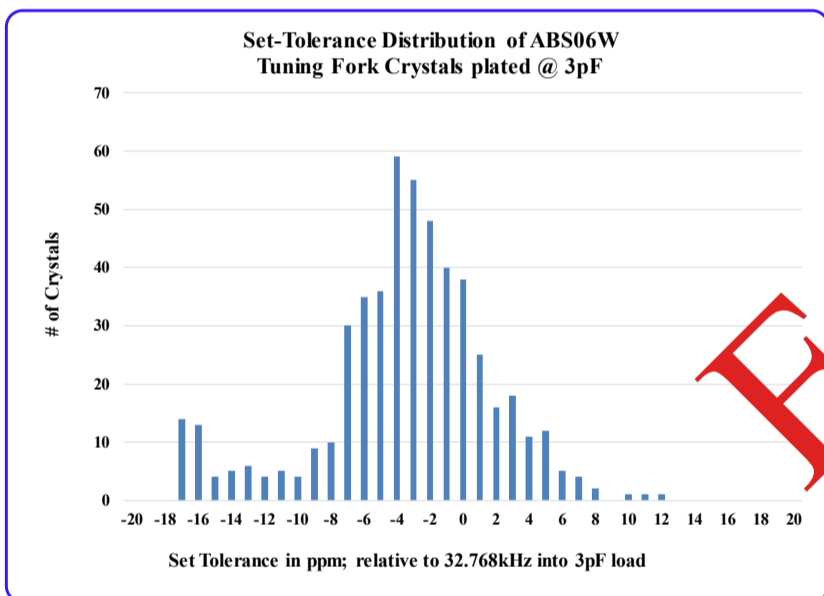

TYPICAL FREQUENCY Vs. TEMPERATURE CHARACTERISTICS

TYPICAL ESR(EQUIVALENT SERIES RESISTANCE) Vs. TEMPERATURE CHARACTERISTICS

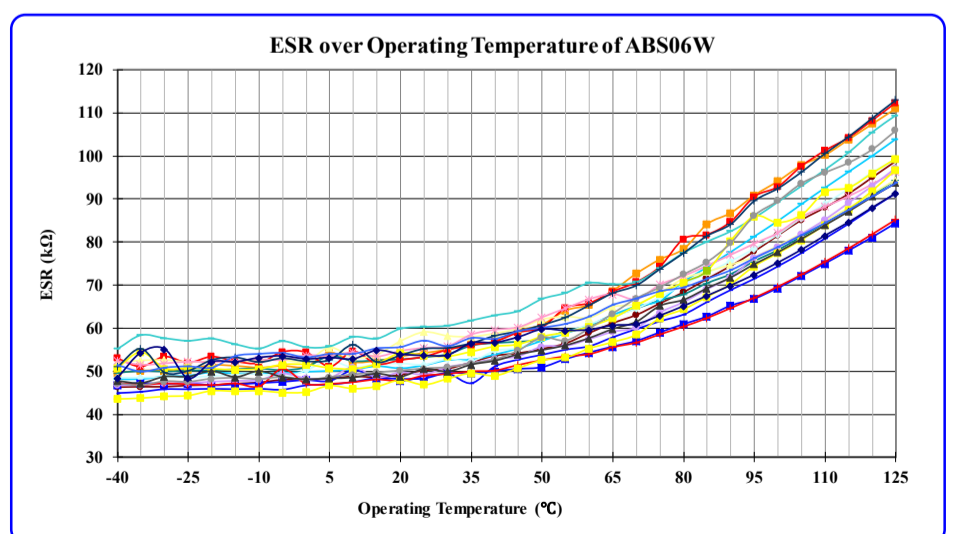
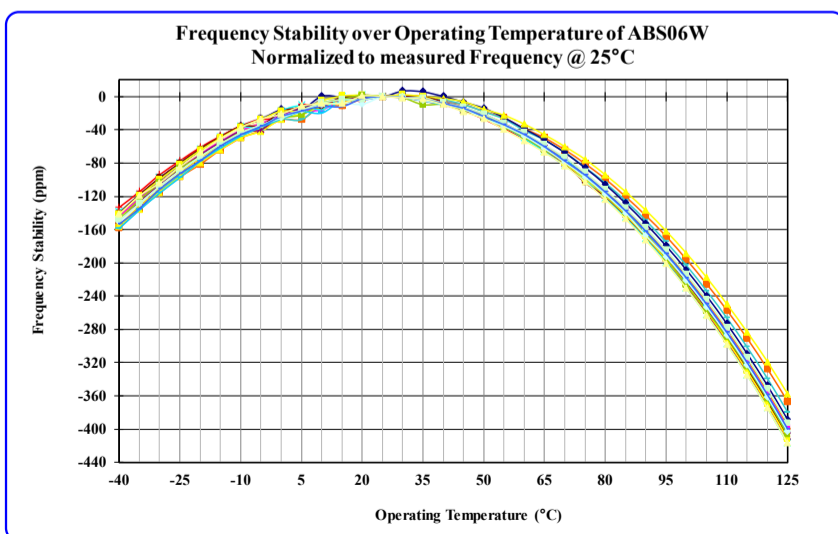

5101 Hidden Creek Ln Spicewood TX 78669
 Phone: 512-371-6159 | Fax: 512-351-8858
 For terms and conditions of sales, please visit:
www.abracon.com

REVISED: 05.26.2021

ABRACON IS
 ISO9001-2015
 CERTIFIED

32.768KHZ IoT OPTIMIZED SMD CRYSTAL

ABS06W



2.0 x 1.2 x 0.6 mm

RoHS/RoHS II Compliant

MSL = N/A: NOT APPLICABLE

SPICE MODEL (BASED ON TYPICAL VALUES AT 25°C ± 3°C):

Quartz Crystal Equivalent Circuit

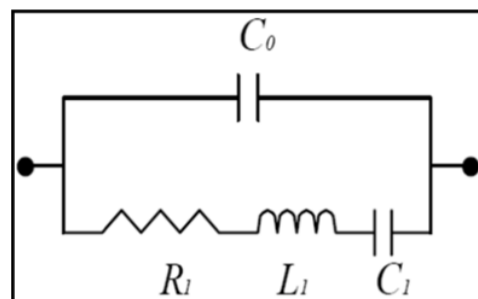

Frequency: 32.78kHz

Plating Load (CL) = 3pF

C0 = 0.90 pF

R1 = 47,594 Ω

L1 = 5,549,000 mH

C1 = 4.26 fF

MECHANICAL DIMENSIONS

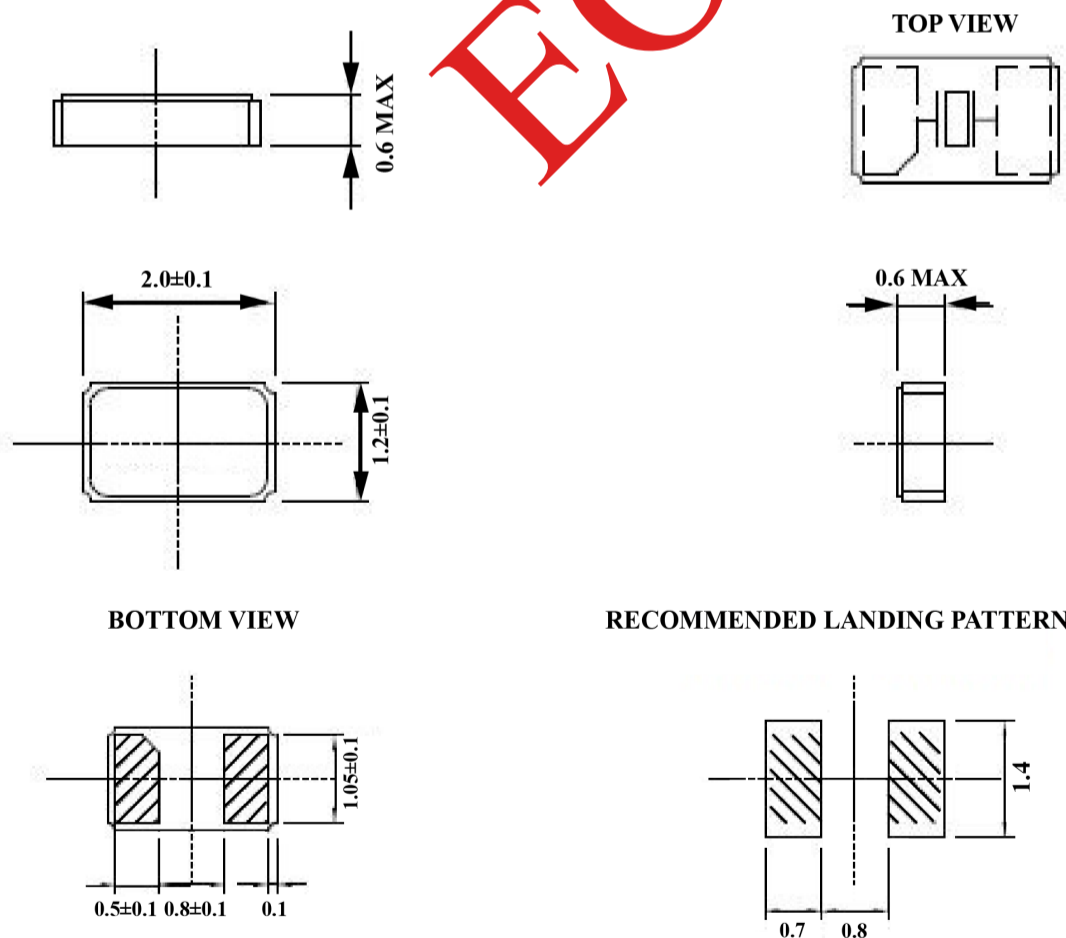

DIMENSIONS: mm



5101 Hidden Creek Ln Spicewood TX 78669
Phone: 512-371-6159 | Fax: 512-351-8858
For terms and conditions of sales, please visit:
www.abracon.com

REVISED: 05.26.2021

ABRACON IS
ISO9001-2015
CERTIFIED

32.768KHZ IoT OPTIMIZED SMD CRYSTAL

ABS06W



2.0 x 1.2 x 0.6 mm

Pb RoHS/RoHS II Compliant

MSL = N/A: NOT APPLICABLE

REFLOW PROFILE [JEDEC J-STD-020]

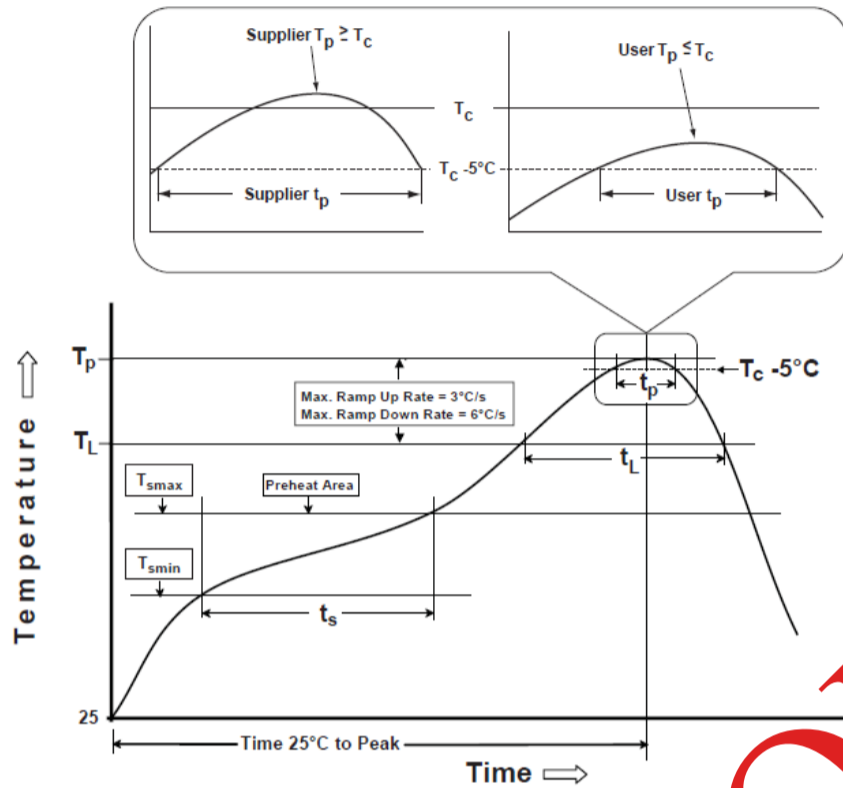

Table 1

SnPb Eutectic Process Classification Temperatures (T_c)		
Package Thickness	Volume mm^3 <350	Volume mm^3 >350
<2.5 mm	235 °C	220 °C
>2.5 mm	220 °C	220 °C

Table 2

Pb-Free Process Classification Temperatures (T_c)			
Package Thickness	Volume mm^3 <350	Volume mm^3 350-2000	Volume mm^3 >2000
<1.6 mm	260 °C	260 °C	260 °C
1.6 mm - 2.5 mm	260 °C	250 °C	245 °C
>2.5 mm	250 °C	245 °C	245 °C

Profile Feature	Sn-Pb Eutectic Assembly	Pb-Free Assembly
Preheat / soak		
Temperature minimum (T_{smin})	100°C	150°C
Temperature maximum (T_{smax})	150°C	200°C
Time (T_{smin} to T_{smax}) (t_s)	60 - 120 sec.	60 - 120 sec.
Average ramp-up rate (T_{smax} to T_p)	3°C/sec. max	3°C/sec. max
Liquidous temperature (T_L)	183°C	217°C
Time at liquidous (t_L)	60 - 150 sec.	60 - 150 sec.
Peak package body temperature (T_p)*	see Table 1	see Table 2
Time (t_p)** within 5°C of the specified classification temperature (T_c)	20 sec.	30 sec.
Ramp-down rate (T_p to T_{smax})	6°C/sec. max	6°C/sec. max
Time 25°C to peak temperature	6 min. max	8 min. max
Reflow cycles	2 max	2 max

*Tolerance for peak profile temperature (T_p) is defined as a supplier minimum and a user maximum.

**Tolerance for time at peak profile temperature (t_p) is defined as a supplier minimum and a user maximum.

32.768KHZ IoT OPTIMIZED SMD CRYSTAL



ABS06W

2.0 x 1.2 x 0.6 mm

RoHS/RoHS II Compliant

MSL = N/A: NOT APPLICABLE

PACKAGING

T= Tape and reel (3,000pcs/reel)

T9= Tape and reel (9,000pcs/reel)

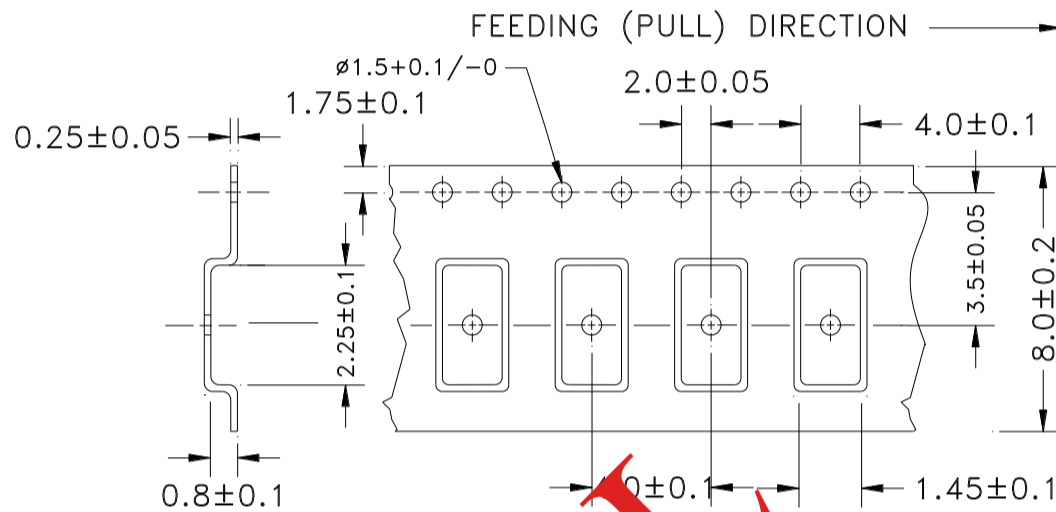

Reel=3,000pcs

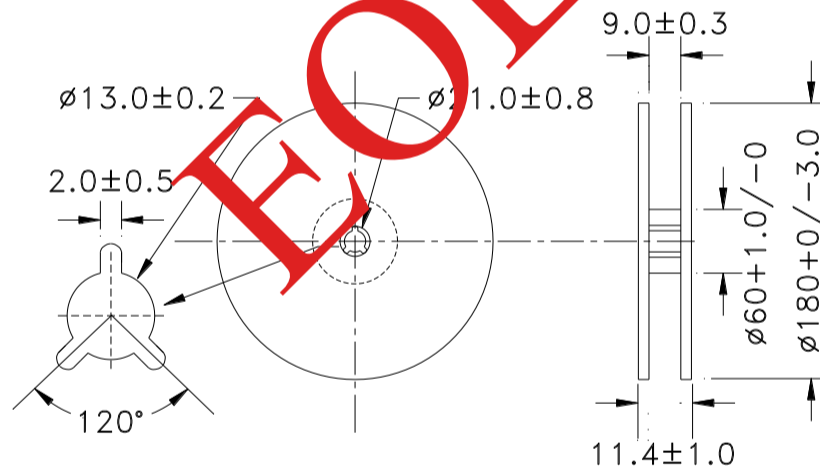

Reel=9,000pcs

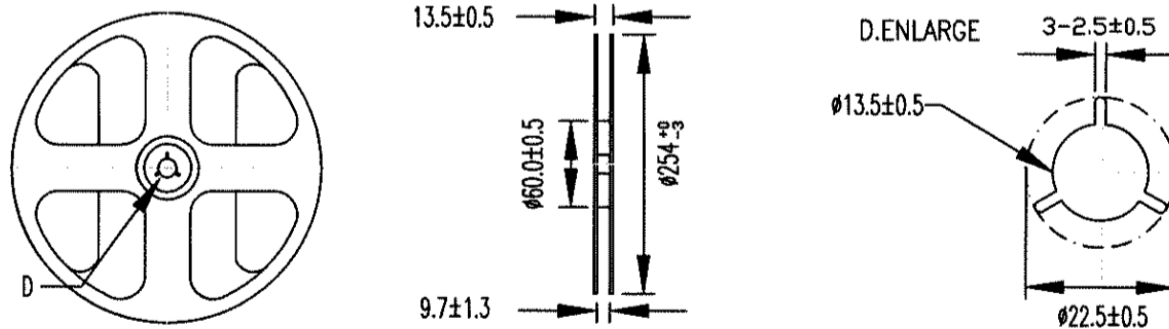

Dimensions: mm



5101 Hidden Creek Ln Spicewood TX 78669
 Phone: 512-371-6159 | Fax: 512-351-8858
 For terms and conditions of sales, please visit:
www.abracon.com

REVISED: 05.26.2021

ABRACON IS
 ISO9001-2015
 CERTIFIED

Looking for pricing, stock, or lifecycle information?

Click below to explore more details on WIN SOURCE:

- [View ABS06W-32.768KHZ-K-2-T on WIN SOURCE](#)
- [Abracon LLC Information](#)

Optimize Your Supply Chain with WIN SOURCE Solutions

- ✓ Global Sourcing Solution
- ✓ Obsolete Management
- ✓ Cost Control Management
- ✓ Shortage Management
- ✓ Alternative Solution
- ✓ Excess Inventory Management