

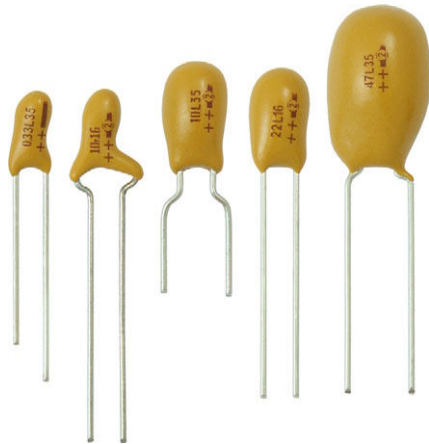

**THE DATASHEET OF  
199D336X9025E6V1E3**



## Solid-Electrolyte TANTALEX™ Capacitors, Resin-Coated, Radial-Lead



### FEATURES

- Terminations: tin / lead (SnPb), 100 % tin (Sn)
- Economy and high performance are combined in these radial-lead, solid-electrolyte TANTALEX™ capacitors
- Rugged, reliable capacitors featuring low leakage current and low dissipation factor
- Six miniature case sizes and five lead styles. All case sizes are available in standard tape and reel packaging per EIA-468
- Standard ratings include replacements for type 196D capacitors
- Lead (Pb)-free capacitors have “L” in body marking
- Material categorization: for definitions of compliance please see [www.vishay.com/doc?99912](http://www.vishay.com/doc?99912)



### Note

\* This datasheet provides information about parts that are RoHS-compliant and / or parts that are non RoHS-compliant. For example, parts with lead (Pb) terminations are not RoHS-compliant. Please see the information / tables in this datasheet for details

### APPLICATIONS

Suitable for a broad range of consumer, commercial and industrial equipment

### PERFORMANCE CHARACTERISTICS

**Operating Temperature:** -55 °C to +85 °C  
(to +125 °C with voltage derating)

**Capacitance Tolerance:** at 120 Hz, +25 °C, ± 20 %, ± 10 % standard. ± 5 % available as special

**Dissipation Factor:** at 120 Hz, +25 °C. Dissipation factor, shall not exceed the values listed in the Standard Ratings tables.

#### DC Leakage Current (DCL Max.):

**at +25 °C:** leakage current shall not exceed the values listed in the Standard Ratings tables.

**at +85 °C:** leakage current shall not exceed 10 times the values listed in the Standard Ratings tables.

**at +125 °C:** leakage shall not exceed 15 times the values listed in the Standard Ratings tables.

**Life Test:** capacitors shall withstand rated DC voltage applied at +85 °C for 1000 h with a circuit resistance not greater than 3 Ω.

Following the life test:

1. DCL shall not exceed 125 % of the initial requirements
2. Dissipation factor shall meet the initial requirement
3. Change in capacitance shall not exceed ± 10 %

ORDERING INFORMATION							
199D	475	X9	003	A	1 <sup>(1)</sup>	V1	E3
MODEL	CAPACITANCE	CAPACITANCE TOLERANCE	DC VOLTAGE RATING AT +85 °C	CASE CODE	LEAD STYLE	PACKAGING	RoHS-COMPLIANT
	This is expressed in picofarads. The first two digits are the significant figures. The third is the number of zeros to follow.	X0 = ± 20 % X9 = ± 10 % ** X5 = ± 5 % ** Special Order	This is expressed in V. To complete the three-digit block, zeros precede the voltage rating. A decimal point is indicated by an “R” (6R3 = 6.3 V).	See Ratings and Case Codes table.		V1 = bulk B1 = tape and reel A1 = tape / ammo box	E3 = 100 % tin termination (RoHS-compliant) Blank = tin / lead termination

### Note

(1) See lead styles table

LEAD STYLE CONFIGURATIONS AND CODES				
STRAIGHT UNEVEN LEADS CODES 1, 3, AND Y	STRAIGHT EVEN LEADS CODES 2, 4, AND 5	“OUTSIDE HOCKEY STICK” CODES 6 AND 7	“SNAP-IN” CODE 9	“HAIRPIN” CODES X, Z

**Notes**

- Wire diameter (nominal) 0.020" (0.51 mm)
- L = lead length
- P = pitch or lead spacing

AVAILABLE LEAD STYLES AND PACKAGING TYPES PER CASE SIZE											
LEAD STYLE / CASE	1	2	3	4	5	6	7	9	X	Y	Z
A	Bulk	Bulk Reel Ammo	-	-	Bulk Reel Ammo	Bulk Reel Ammo	Bulk Reel Ammo	Bulk Reel Ammo	Bulk Reel Ammo	Bulk	Bulk Reel Ammo
B											
C											
D											
E	-	-	Bulk	Bulk / Reel Ammo	-	-	-	-	-	-	
F	-	-	Bulk	Bulk / Reel Ammo	-	-	-	-	-	-	

DIMENSIONS FOR LEAD STYLES 1, 2, 3, 4, 5, Y, 6 in inches [millimeters]										
LEAD STYLE		1, 2, 3, 4		1, 3	2, 4	5, Y		6		
CASE	D (max.)	P <sup>(1)</sup> ± 0.024 [0.60]	H (max.)	L <sup>(2)</sup> (min.)	L <sup>(2)</sup> ± 0.118 [3.0]	P <sup>(1)</sup> ± 0.03 [0.76]	L <sup>(2)</sup> ± 0.118 [3.0]	P <sup>(1)</sup> ± 0.024 [0.60]	H <sub>1</sub> (max.)	L <sup>(2)</sup>
A	0.173 [4.40]	0.100 [2.54]	0.280 [7.11]	0.591 [15.0]	0.748 [19.0]	0.125 [3.18]	0.748 [19.0]	0.200 [5.08]	0.378 [9.61]	0.240 ± 0.030 [6.1 ± 0.76]
B	0.197 [5.00]	0.100 [2.54]	0.300 [7.62]	0.591 [15.0]	0.748 [19.0]	0.125 [3.18]	0.748 [19.0]	0.200 [5.08]	0.398 [10.11]	0.240 ± 0.030 [6.1 ± 0.76]
C	0.217 [5.50]	0.100 [2.54]	0.360 [9.14]	0.591 [15.0]	0.748 [19.0]	0.125 [3.18]	0.748 [19.0]	0.200 [5.08]	0.458 [11.64]	0.240 ± 0.030 [6.1 ± 0.76]
D	0.236 [6.00]	0.100 [2.54]	0.400 [10.16]	0.591 [15.0]	0.748 [19.0]	0.125 [3.18]	0.748 [19.0]	0.200 [5.08]	0.498 [12.66]	0.240 ± 0.030 [6.1 ± 0.76]
E	0.339 [8.60]	0.200 [5.08]	0.492 [12.50]	0.591 [15.0]	0.748 [19.0]	n/a	n/a	0.200 [5.08]	0.591 [15.00]	1.0 ± 0.122 [25.4 ± 3.1]
F	0.378 [9.60]	0.200 [5.08]	0.650 [16.50]	0.591 [15.0]	0.748 [19.0]	n/a	n/a	0.200 [5.08]	0.748 [19.00]	1.0 ± 0.122 [25.4 ± 3.1]

**Notes**

- (1) Pitch or lead spacing P measured within 0.05" [1.27 mm] of the body of the capacitor or from the bottom of the crimp
- (2) Lead length L is for bulk packaging



DIMENSIONS FOR LEAD STYLES 7, 9, X, Z in inches [millimeters]													
LEAD STYLE		7			9			X, Z				X	Z
CASE	D max.	P <sup>(1)</sup> ± 0.024 [0.60]	H <sub>1</sub> max.	L <sup>(2)</sup> ± 0.03 [0.76]	P <sup>(1)</sup> ± 0.024 [0.60]	H <sub>1</sub> max.	L <sup>(2)</sup> ± 0.03 [0.76]	D max.	H max.	H <sub>1</sub> max.	L <sup>(2)</sup> ± 0.125 [3.175]	P <sup>(1)</sup> ± 0.024 [0.60]	P <sup>(1)</sup> ± 0.024 [0.60]
A	0.173 [4.40]	0.25 [6.35]	0.378 [9.61]	0.240 ± 0.030 [6.1 ± 0.76]	0.200 [5.08]	0.398 [10.11]	0.240 [6.10]	0.173 [4.40]	0.280 [7.11]	0.340 [8.64]	0.750 [19.05]	0.100 [2.54]	0.125 [3.175]
B	0.197 [5.00]	0.25 [6.35]	0.398 [10.12]	0.240 ± 0.030 [6.1 ± 0.76]	0.200 [5.08]	0.418 [10.62]	0.240 [6.10]	0.197 [5.00]	0.300 [7.62]	0.360 [9.14]	0.750 [19.05]	0.100 [2.54]	0.125 [3.175]
C	0.217 [5.50]	0.25 [6.35]	0.458 [11.64]	0.240 ± 0.030 [6.1 ± 0.76]	0.200 [5.08]	0.478 [12.14]	0.240 [6.10]	0.217 [5.50]	0.360 [9.14]	0.420 [10.67]	0.750 [19.05]	0.100 [2.54]	0.125 [3.175]
D	0.236 [6.00]	0.25 [6.35]	0.498 [12.66]	0.240 ± 0.030 [6.1 ± 0.76]	0.200 [5.08]	0.518 [13.16]	0.240 [6.10]	0.236 [6.00]	0.400 [10.16]	0.460 [11.68]	0.750 [19.05]	0.100 [2.54]	0.125 [3.175]

Notes

- (1) Pitch or lead spacing P measured within 0.05" [1.27 mm] of the body of the capacitor or from the bottom of the crimp
- (2) Lead length L is for bulk packaging

199D OBSOLETE VS. CURRENT ORDERING CROSS REFERENCE		
OBSOLETE	NEW	DESCRIPTION
A1	1V1	PITCH 0.100, UNEVEN STRAIGHT LEADS, BULK CASES A - D
A1	3V1	PITCH 0.200, UNEVEN STRAIGHT LEADS, BULK, CASES E, F
A1	2V1	PITCH 0.100, EVEN STRAIGHT LEADS, BULK, CASES A - D
A6	2B1	PITCH 0.100, EVEN STRAIGHT LEADS, REEL POSITIVE LEADER, CASES A - D
A6	2A1	PITCH 0.100, EVEN STRAIGHT LEADS, AMMO, CASES A - D
A1	4V1	PITCH 0.200, EVEN STRAIGHT LEADS, BULK, CASES E, F
A6	4B1	PITCH 0.200, EVEN STRAIGHT LEADS, REEL POSITIVE LEADER, CASES E, F
A6	4A1	PITCH 0.200, EVEN STRAIGHT LEADS, AMMO, CASES E, F
A2	5V1	PITCH 0.125, EVEN STRAIGHT LEADS, BULK, CASES A - D
A7	5B1	PITCH 0.125, EVEN STRAIGHT LEADS, REEL POSITIVE LEADER, CASES A - D
A7	5A1	PITCH 0.125, EVEN STRAIGHT LEADS, AMMO, CASES A - D
A2	YV1	PITCH 0.125, UNEVEN STRAIGHT LEADS, BULK, CASES A - D
B1	XV1	PITCH 0.100, HAIRPIN LEADS, BULK CASES A - D
B6	XB1	PITCH 0.100, HAIRPIN LEADS, REEL POSITIVE LEADER, CASES A - D
B6	XA1	PITCH 0.100, HAIRPIN LEADS, AMMO, CASES A - D
B2	ZV1	PITCH 0.125, HAIRPIN LEADS, BULK, CASES A - D
B7	ZB1	PITCH 0.125, HAIRPIN LEADS, REEL POSITIVE LEADER, CASES A - D
B7	ZA1	PITCH 0.125, HAIRPIN LEADS, AMMO, CASES A - D
E2	6V1	PITCH 0.200, HOCKEY STICK LEADS, BULK, CASES A - F
E7	6B1	PITCH 0.200, HOCKEY STICK LEADS, REEL POSITIVE LEADER, CASES A - F
E7	6A1	PITCH 0.200, HOCKEY STICK LEADS, AMMO, CASES A - F
E3	7V1	PITCH 0.250, HOCKEY STICK LEADS, BULK, CASES A - D
E8	7B1	PITCH 0.250, HOCKEY STICK LEADS, REEL POSITIVE LEADER, CASES A - D
E8	7A1	PITCH 0.250, HOCKEY STICK LEADS, AMMO, CASES A - D
E4		OBSOLETE
G2	9V1	PITCH 0.200, SNAP-IN LEADS, BULK, CASES A - D
G7	9B1	PITCH 0.200, SNAP-IN LEADS, REEL POSITIVE LEADER, CASES A - D
G7	9A1	PITCH 0.200, SNAP-IN LEADS, AMMO, CASES A - D



STANDARD RATINGS				
CAPACITANCE ( $\mu$ F)	CASE CODE	PART NUMBER	MAX. DCL AT +25 °C ( $\mu$ A)	MAX. DF AT +25 °C 120 Hz (%)
<b>3 V<sub>DC</sub> AT +85 °C, SURGE = 3.6 V; 2 V<sub>DC</sub> AT +125 °C, SURGE = 2.4 V</b>				
4.7	A	199D475(1)003A(2)(3)	0.5	6
6.8	A	199D685(1)003A(2)(3)	0.5	6
10	A	199D106(1)003A(2)(3)	0.5	8
15	A	199D156(1)003A(2)(3)	0.5	8
22	B	199D226(1)003B(2)(3)	0.6	8
33	B	199D336(1)003B(2)(3)	1.0	8
47	C	199D476(1)003C(2)(3)	1.4	8
68	C	199D686(1)003C(2)(3)	2.0	8
100	D	199D107(1)003D(2)(3)	3.0	10
150	D	199D157(1)003D(2)(3)	4.0	10
220	E	199D227(1)003E(2)(3)	5.0	10
330	E	199D337(1)003E(2)(3)	6.0	10
470	F	199D477(1)003F(2)(3)	8.0	10
680	F	199D687(1)003F(2)(3)	10.0	10
<b>6.3 V<sub>DC</sub> AT +85 °C, SURGE = 8 V; 4 V<sub>DC</sub> AT +125 °C, SURGE = 5 V</b>				
4.7	A	199D475(1)6R3A(2)(3)	0.5	6
6.8	A	199D685(1)6R3A(2)(3)	0.5	6
10	B	199D106(1)6R3B(2)(3)	0.6	8
15	B	199D156(1)6R3B(2)(3)	0.9	8
22	C	199D226(1)6R3C(2)(3)	1.3	8
33	C	199D336(1)6R3C(2)(3)	2.0	8
47	D	199D476(1)6R3D(2)(3)	2.9	8
68	D	199D686(1)6R3D(2)(3)	4.0	8
100	D	199D107(1)6R3D(2)(3)	5.0	10
150	E	199D157(1)6R3E(2)(3)	6.0	10
220	E	199D227(1)6R3E(2)(3)	7.0	10
330	F	199D337(1)6R3F(2)(3)	8.0	10
<b>10 V<sub>DC</sub> AT +85 °C, SURGE = 13 V; 7 V<sub>DC</sub> AT +125 °C, SURGE = 9 V</b>				
3.3	A	199D335(1)010A(2)(3)	0.5	6
4.7	A	199D475(1)010A(2)(3)	0.5	6
6.8	B	199D685(1)010B(2)(3)	0.6	6
10	B	199D106(1)010B(2)(3)	1.0	8
15	C	199D156(1)010C(2)(3)	1.5	8
22	C	199D226(1)010C(2)(3)	2.0	8
33	D	199D336(1)010D(2)(3)	3.0	8
39	D	199D396(1)010D(2)(3)	3.9	8
47	D	199D476(1)010D(2)(3)	4.0	8
68	D	199D686(1)010D(2)(3)	5.0	8
100	E	199D107(1)010E(2)(3)	6.0	10
150	E	199D157(1)010E(2)(3)	7.0	10
220	F	199D227(1)010F(2)(3)	8.0	10

**Note**

- Part number definitions:
  - For capacitance tolerance: X0 =  $\pm$  20 %, X9 =  $\pm$  10 % or X5 = 5 %
  - To specify lead style / spacing / packaging insert the last three characters in the part number. Use the appropriate code shown in the Current Ordering Cross Reference table and explained in the Ordering Information and Lead Styles table
  - E3 = RoHS-compliant 100 % tin leads. Blank or no suffix = standard tin / lead termination



STANDARD RATINGS				
CAPACITANCE ( $\mu$ F)	CASE CODE	PART NUMBER	MAX. DCL AT +25 °C ( $\mu$ A)	MAX. DF AT +25 °C 120 Hz (%)
<b>16 V<sub>DC</sub> AT +85 °C, SURGE = 20 V; 10 V<sub>DC</sub> AT +125 °C, SURGE = 12 V</b>				
2.2	A	199D225(1)016A(2)(3)	0.5	6
3.3	A	199D335(1)016A(2)(3)	0.5	6
4.7	B	199D475(1)016B(2)(3)	0.7	6
6.8	B	199D685(1)016B(2)(3)	1.0	6
10	C	199D106(1)016C(2)(3)	1.5	8
15	C	199D156(1)016C(2)(3)	2.4	8
22	D	199D226(1)016D(2)(3)	3.5	8
33	D	199D336(1)016D(2)(3)	4.0	8
47	E	199D476(1)016E(2)(3)	5.0	8
68	E	199D686(1)016E(2)(3)	6.0	8
100	F	199D107(1)016F(2)(3)	7.0	10
150	F	199D157(1)016F(2)(3)	8.0	10
<b>20 V<sub>DC</sub> AT +85 °C, SURGE = 26 V; 13 V<sub>DC</sub> AT +125 °C, SURGE = 16 V</b>				
1.0	A	199D105(1)020A(2)(3)	0.5	4
2.7	B	199D275(1)020B(2)(3)	0.7	6
3.3	B	199D335(1)020B(2)(3)	0.8	6
4.7	B	199D475(1)020B(2)(3)	1.0	6
6.8	C	199D685(1)020C(2)(3)	1.5	6
10	C	199D106(1)020C(2)(3)	2.0	8
15	D	199D156(1)020D(2)(3)	2.5	8
22	D	199D226(1)020D(2)(3)	3.0	8
33	E	199D336(1)020E(2)(3)	4.0	8
47	E	199D476(1)020E(2)(3)	5.0	8
68	F	199D686(1)020F(2)(3)	6.0	8
100	F	199D107(1)020F(2)(3)	7.0	10
<b>25 V<sub>DC</sub> AT +85 °C, SURGE = 33 V; 17 V<sub>DC</sub> AT +125 °C, SURGE = 21 V</b>				
1.0	A	199D105(1)025A(2)(3)	0.5	4
1.5	A	199D155(1)025A(2)(3)	0.5	6
2.2	A	199D225(1)025A(2)(3)	0.5	6
3.3	B	199D335(1)025B(2)(3)	0.8	6
4.7	B	199D475(1)025B(2)(3)	1.0	6
6.8	C	199D685(1)025C(2)(3)	1.5	6
10	C	199D106(1)025C(2)(3)	2.5	8
15	D	199D156(1)025D(2)(3)	3.0	8
22	D	199D226(1)025D(2)(3)	4.0	8
33	E	199D336(1)025E(2)(3)	5.0	8
47	E	199D476(1)025E(2)(3)	6.0	8
68	F	199D686(1)025F(2)(3)	7.0	8

**Note**

- Part number definitions:

(1) For capacitance tolerance: X0 =  $\pm$  20 %, X9 =  $\pm$  10 % or X5 = 5 %

(2) To specify lead style / spacing / packaging insert the last three characters in the part number. Use the appropriate code shown in the Current Ordering Cross Reference table and explained in the Ordering Information and Lead Styles table

(3) E3 = RoHS-compliant 100 % tin leads. Blank or no suffix = standard tin / lead termination



STANDARD RATINGS					
CAPACITANCE ( $\mu$ F)	CASE CODE	PART NUMBER	MAX. DCL AT +25 °C ( $\mu$ A)	MAX. DF AT +25 °C 120 Hz (%)	
<b>35 V<sub>DC</sub> AT +85 °C, SURGE = 46 V; 23 V<sub>DC</sub> AT +125 °C, SURGE = 28 V</b>					
0.10	A	199D104(1)035A(2)(3)	0.5	4	
0.15	A	199D154(1)035A(2)(3)	0.5	4	
0.22	A	199D224(1)035A(2)(3)	0.5	4	
0.33	A	199D334(1)035A(2)(3)	0.5	4	
0.47	A	199D474(1)035A(2)(3)	0.5	4	
0.68	A	199D684(1)035A(2)(3)	0.5	4	
1.0	A	199D105(1)035A(2)(3)	0.5	4	
1.5	A	199D155(1)035A(2)(3)	0.5	6	
1.8	B	199D185(1)035B(2)(3)	0.7	6	
2.2	B	199D225(1)035B(2)(3)	0.7	6	
3.3	B	199D335(1)035B(2)(3)	1.0	6	
4.7	C	199D475(1)035C(2)(3)	1.5	6	
5.6	D	199D565(1)035D(2)(3)	1.9	6	
6.8	D	199D685(1)035D(2)(3)	2.3	6	
10	D	199D106(1)035D(2)(3)	3.5	8	
15	E	199D156(1)035E(2)(3)	4.0	8	
22	E	199D226(1)035E(2)(3)	5.0	8	
33	F	199D336(1)035F(2)(3)	6.0	8	
47	F	199D476(1)035F(2)(3)	7.0	8	
<b>50 V<sub>DC</sub> AT +85 °C, SURGE = 65 V; 33 V<sub>DC</sub> AT +125 °C, SURGE = 40 V</b>					
0.10	A	199D104(1)050A(2)(3)	0.5	4	
0.15	A	199D154(1)050A(2)(3)	0.5	4	
0.22	A	199D224(1)050A(2)(3)	0.5	4	
0.33	A	199D334(1)050A(2)(3)	0.5	4	
0.47	A	199D474(1)050A(2)(3)	0.5	4	
0.68	A	199D684(1)050A(2)(3)	0.5	4	
1.0	B	199D105(1)050B(2)(3)	0.5	4	
1.5	C	199D155(1)050C(2)(3)	0.7	6	
2.2	C	199D225(1)050C(2)(3)	1.1	6	
3.3	D	199D335(1)050D(2)(3)	1.5	6	
4.7	D	199D475(1)050D(2)(3)	2.0	6	
6.8	F	199D685(1)050F(2)(3)	3.0	6	
10	F	199D106(1)050F(2)(3)	4.0	8	
15	F	199D156(1)050F(2)(3)	5.0	8	
22	F	199D226(1)050F(2)(3)	6.0	8	

**Note**

- Part number definitions:
  - For capacitance tolerance: X0 =  $\pm$  20 %, X9 =  $\pm$  10 % or X5 = 5 %
  - To specify lead style / spacing / packaging insert the last three characters in the part number. Use the appropriate code shown in the Current Ordering Cross Reference table and explained in the Ordering Information and Lead Styles table
  - E3 = RoHS-compliant 100 % tin leads. Blank or no suffix = standard tin / lead termination

**STANDARD TAPE AND REEL / AMMO BOX PACKAGING DIMENSIONS PER EIA-468**

in inches [millimeters]

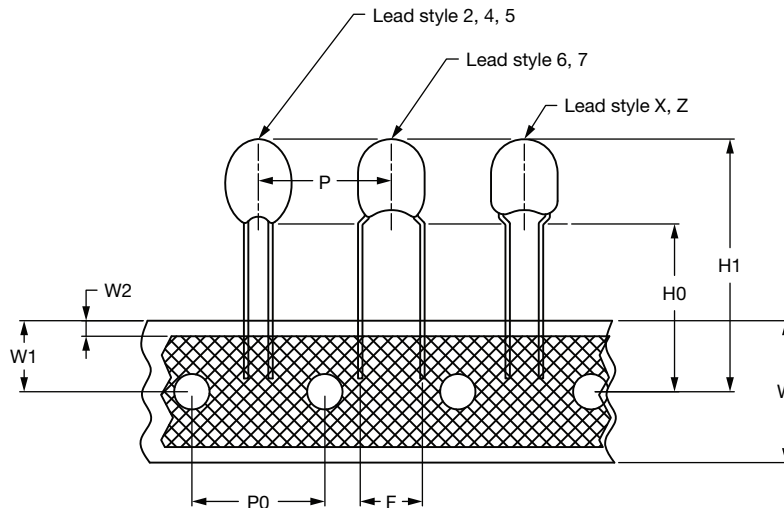

SYMBOL	DESCRIPTION	DIMENSIONS	TOLERANCE
P	Component pitch	0.500 [12.7]	$\pm 0.039$ [ $\pm 1.0$ ]
P0	Feed hole pitch	0.500 [12.7]	$\pm 0.012$ [ $\pm 0.3$ ]
W	Tape width	0.709 [18.0]	+0.039 / -0.020 [ $+1.0$ / -0.5]
W0	Hold down tape width	0.20 [5.0]	Minimum
W1	Feed hole position	0.354 [9.0]	+0.030 / -0.020 [ $+0.075$ / -0.5]
W2	Hold down tape position	0.118 [3.0]	Maximum
H1	Overall component height above tape central line	1.27 [32.26]	Maximum
D0	Feed hole diameter	0.157 [4.0]	$\pm 0.012$ [ $\pm 0.3$ ]
t	Tape thickness	0.028 [0.7]	Maximum
H0	Height to seating plane	0.63 [16.0]	$\pm 0.02$ [ $\pm 0.5$ ]
F	Pitch or lead wire spacing	See "Dimensions for Lead Styles" tables	

**Tape and Reel Packaging:** type 199D radial-leaded tantalum capacitors, all lead styles except 1, 3, and Y are available taped and reeled per EIA-468.

CASE CODE	A	B	C	D	E	F
Quantity per box bulk	1000		500		100	
Quantity per box ammpack	2500	2000	1500	1000	500	
Quantity per reel	1000				500	

PRODUCT INFORMATION	
Mounting of Through Hole Components	<a href="http://www.vishay.com/doc?40108">www.vishay.com/doc?40108</a>
Solid Tantalum Capacitors (With MnO <sub>2</sub> Electrolyte) Voltage Derating	<a href="http://www.vishay.com/doc?40246">www.vishay.com/doc?40246</a>
SELECTOR GUIDES	
Selector Guide	<a href="http://www.vishay.com/doc?49054">www.vishay.com/doc?49054</a>
FAQ	
Frequently Asked Questions	<a href="http://www.vishay.com/doc?40110">www.vishay.com/doc?40110</a>



## Disclaimer

ALL PRODUCT, PRODUCT SPECIFICATIONS AND DATA ARE SUBJECT TO CHANGE WITHOUT NOTICE TO IMPROVE RELIABILITY, FUNCTION OR DESIGN OR OTHERWISE.

Vishay Intertechnology, Inc., its affiliates, agents, and employees, and all persons acting on its or their behalf (collectively, "Vishay"), disclaim any and all liability for any errors, inaccuracies or incompleteness contained in any datasheet or in any other disclosure relating to any product.

Vishay makes no warranty, representation or guarantee regarding the suitability of the products for any particular purpose or the continuing production of any product. To the maximum extent permitted by applicable law, Vishay disclaims (i) any and all liability arising out of the application or use of any product, (ii) any and all liability, including without limitation special, consequential or incidental damages, and (iii) any and all implied warranties, including warranties of fitness for particular purpose, non-infringement and merchantability.

Statements regarding the suitability of products for certain types of applications are based on Vishay's knowledge of typical requirements that are often placed on Vishay products in generic applications. Such statements are not binding statements about the suitability of products for a particular application. It is the customer's responsibility to validate that a particular product with the properties described in the product specification is suitable for use in a particular application. Parameters provided in datasheets and / or specifications may vary in different applications and performance may vary over time. All operating parameters, including typical parameters, must be validated for each customer application by the customer's technical experts. Product specifications do not expand or otherwise modify Vishay's terms and conditions of purchase, including but not limited to the warranty expressed therein.

Hyperlinks included in this datasheet may direct users to third-party websites. These links are provided as a convenience and for informational purposes only. Inclusion of these hyperlinks does not constitute an endorsement or an approval by Vishay of any of the products, services or opinions of the corporation, organization or individual associated with the third-party website. Vishay disclaims any and all liability and bears no responsibility for the accuracy, legality or content of the third-party website or for that of subsequent links.

Except as expressly indicated in writing, Vishay products are not designed for use in medical, life-saving, or life-sustaining applications or for any other application in which the failure of the Vishay product could result in personal injury or death. Customers using or selling Vishay products not expressly indicated for use in such applications do so at their own risk. Please contact authorized Vishay personnel to obtain written terms and conditions regarding products designed for such applications.

No license, express or implied, by estoppel or otherwise, to any intellectual property rights is granted by this document or by any conduct of Vishay. Product names and markings noted herein may be trademarks of their respective owners.







## Looking for pricing, stock, or lifecycle information?

Click below to explore more details on WIN SOURCE:

 [View 199D336X9025E6V1E3 on WIN SOURCE](#)

 [Vishay Information](#)

## Optimize Your Supply Chain with WIN SOURCE Solutions

-  Global Sourcing Solution
-  Obsolete Management
-  Cost Control Management
-  Shortage Management
-  Alternative Solution
-  Excess Inventory Management