

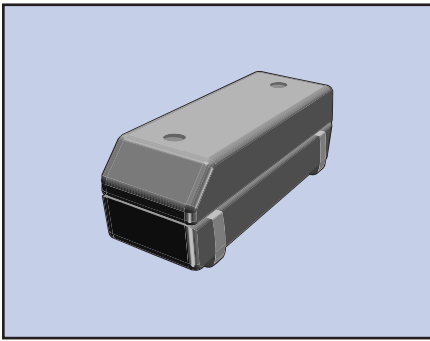

**THE DATASHEET OF
ECS-73-20-7S-TR**





This wide frequency range SMD quartz crystal is an excellent choice for surface mount applications. The ruggedized molded package is made from the same thermoplastic that is industry standard for integrated circuits.

FEATURES

- Low profile
- Industry standard footprint
- High temperature seal capabilities
- Excellent shock resistance
- Excellent environmental characteristics
- Tape and Reel (1000 pcs)

PART NUMBERING GUIDE "EXAMPLE"

	FREQUENCY (16.0000 MHz)	LOAD CAPACITANCE*	PACKAGE TYPE
ECS	160	20	7S

* Load capacitance (xx=xx pF, S= series resonance)
 Note: See Product Selection Guide for additional options.

OPERATING CONDITIONS/ELECTRICAL CHARACTERISTICS

PARAMETERS	CONDITIONS	MINIMUM	TYPICAL	MAXIMUM	UNITS
FREQUENCY RANGE	f_0	3.57		70.00	MHz
SHUNT CAPACITANCE	C_0			7.0	pF
LOAD CAPACITANCE	C_L (Customer Specified)	12	20.0 standard	Series	pF
DRIVE LEVEL	3.50 ~ 70.00MHz			100	μ W
CALIBRATION TOLERANCE	@ 25°C	-30		+30	PPM
FREQUENCY STABILITY	$\Delta f/f_0$	-50		+50	PPM
OPERATING TEMPERATURE RANGE	T_{OPR}	-10		+70	°C
STORAGE TEMPERATURE RANGE	T_{STG}	-40		+85	°C

EQUIVALENT SERIES RESISTANCE / MODE OF OSCILLATION

FREQUENCY RANGE (MHz)	MODE	MAX ESR Ω	FREQUENCY RANGE (MHz)	MODE	MAX ESR Ω
3.570 ~ 3.999	Fundamental	250	9.000 ~ 12.999	Fundamental	60
4.000 ~ 4.999	Fundamental	150	13.000 ~ 19.999	Fundamental	40
5.000 ~ 5.999	Fundamental	120	20.000 ~ 30.000	Fundamental	30
6.000 ~ 6.999	Fundamental	100	30.000 ~ 70.000	3rd O/T	100
7.000 ~ 8.999	Fundamental	80			

PACKAGE DIMENSIONS (mm)

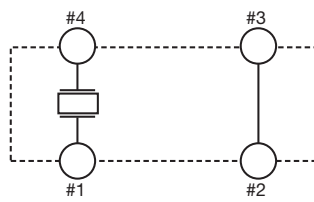
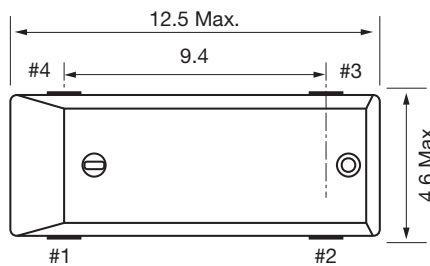

Figure 2) Internal Connections - Top view

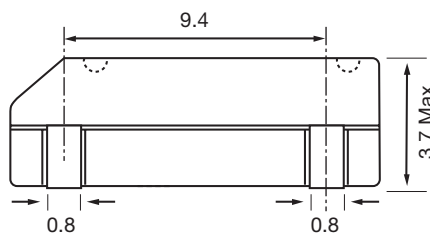

Figure 1) ECX-3S - Top, Side and End views

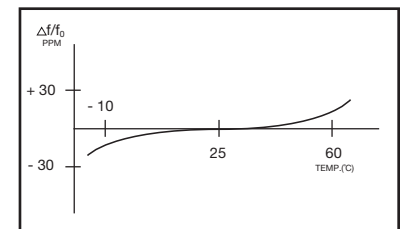
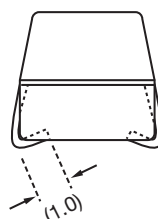

Figure 3) Frequency vs Temperature Curve

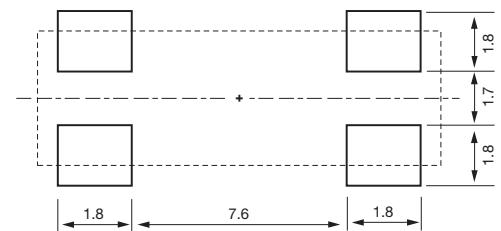

Figure 4) ECX-3S Land Pattern - Bottom view

Looking for pricing, stock, or lifecycle information?

Click below to explore more details on WIN SOURCE:

 [View ECS-73-20-7S-TR on WIN SOURCE](#)

 [ECS Inc. Information](#)

Optimize Your Supply Chain with WIN SOURCE Solutions

-  Global Sourcing Solution
-  Obsolete Management
-  Cost Control Management
-  Shortage Management
-  Alternative Solution
-  Excess Inventory Management