

TPS2295x 5.7 V, 5 A, 14 mΩ On-Resistance Load Switch

1 Features

- Integrated Single Channel Load Switch
- Input Voltage Range: 0.7 V to 5.7 V
- R_{ON} Resistance
 - $R_{ON} = 14\text{ m}\Omega$ at $V_{IN} = 5\text{ V}$ ($V_{BIAS} = 5\text{ V}$)
- 5-A Maximum Continuous Switch Current
- Adjustable Undervoltage Lockout Threshold (UVLO)
- Adjustable Voltage Supervisor with Power Good (PG) Indicator
- Adjustable Output Slew Rate Control
- Enhanced Quick Output Discharge Remains Active after Power is Removed (TPS22954 Only)
 - $15\ \Omega$ (Typ) Discharges $100\ \mu\text{F}$ Within 10 ms
- Reverse Current Blocking when Disabled (TPS22953 Only)
- Automatic Restart after Supervisor Fault Detection When Enabled
- Thermal Shutdown
- Low Quiescent Current $\leq 50\ \mu\text{A}$
- SON 10-pin Package with Thermal Pad
- ESD Performance Tested Per JESD 22
 - 2-kV HBM and 750-V CDM

2 Applications

- Solid State Drives
- Embedded and Industrial PC
- Ultrabook™ and Notebooks
- Desktops
- Servers
- Telecom Systems

3 Description

The TPS22953/54 are small, single channel load switches with controlled turn on. The devices contain a N-channel MOSFET that can operate over an input voltage range of 0.7 V to 5.7 V and can support a maximum continuous current of 5 A.

The integrated adjustable undervoltage lockout (UVLO) and adjustable power good (PG) threshold provides voltage monitoring as well as robust power sequencing. The adjustable rise time control of the device greatly reduces inrush current for a wide variety of bulk load capacitances, thereby reducing or eliminating power supply droop. The switch is independently controlled by an on and off input (EN), which is capable of interfacing directly with low-voltage control signals. A $15\text{-}\Omega$ on-chip load is integrated into the device for a quick discharge of the output when switch is disabled. The enhanced Quick Output Discharge (QOD) remains active for short time after power is removed from the device to finish discharging the output.

The TPS22953/54 are available in small, space-saving 10-SON packages with integrated thermal pad allowing for high power dissipation. The device is characterized for operation over the free-air temperature range of -40°C to $+105^\circ\text{C}$.

Device Information⁽¹⁾

PART NUMBER	PACKAGE (PIN)	BODY SIZE (NOM)
TPS2295x	WSON (10)	2.00 mm x 2.00 mm
	WSON (10)	2.00 mm x 3.00 mm

(1) For all available packages, see the orderable addendum at the end of the datasheet.

Simplified Schematic

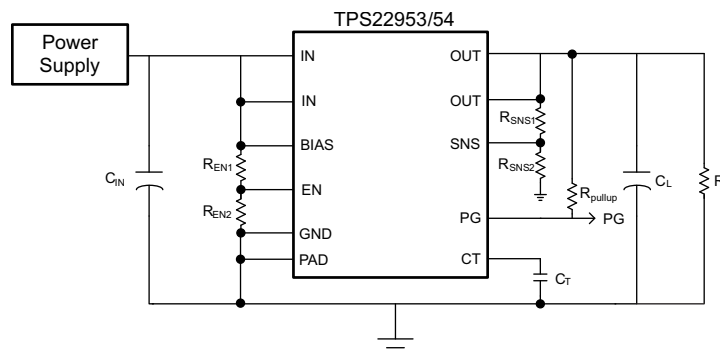

Table of Contents

1 Features	1	9.1 Overview	21
2 Applications	1	9.2 Functional Block Diagram	21
3 Description	1	9.3 Feature Description	22
4 Revision History	2	9.4 Device Functional Modes	28
5 Device Comparison Table	3	10 Application and Implementation	29
6 Pin Configuration and Functions	3	10.1 Application Information	29
7 Specifications	4	10.2 Typical Application	34
7.1 Absolute Maximum Ratings	4	11 Power Supply Recommendations	37
7.2 ESD Ratings	4	12 Layout	37
7.3 Recommended Operating Conditions	4	12.1 Layout Guidelines	37
7.4 Thermal Information	5	12.2 Layout Example	37
7.5 Electrical Characteristics	5	13 Device and Documentation Support	38
7.6 Electrical Characteristics— $V_{BIAS} = 5\text{ V}$	6	13.1 Documentation Support	38
7.7 Electrical Characteristics— $V_{BIAS} = 3.3\text{ V}$	7	13.2 Related Links	38
7.8 Electrical Characteristics— $V_{BIAS} = 2.5\text{ V}$	8	13.3 Receiving Notification of Documentation Updates	38
7.9 Switching Characteristics— $CT = 1000\text{ pF}$	9	13.4 Community Resources	38
7.10 Switching Characteristics— $CT = 0\text{ pF}$	10	13.5 Trademarks	38
7.11 Typical DC Characteristics	11	13.6 Electrostatic Discharge Caution	38
7.12 Typical Switching Characteristics	14	13.7 Glossary	38
8 Parameter Measurement Information	20	14 Mechanical, Packaging, and Orderable Information	39
9 Detailed Description	21		

4 Revision History

NOTE: Page numbers for previous revisions may differ from page numbers in the current version.

Changes from Revision C (July 2015) to Revision D	Page
• Added Power Sequencing section.	28

Changes from Revision B (May 2015) to Revision C	Page
• Changed inverter part number from SN74LVC1G07 to SN74LVC1G06 in the Break-Before-Make Power MUX Schematic.	32

Changes from Revision A (April 2015) to Revision B	Page
• Updated pin names and graphics throughout the document.	1

Changes from Original (March 2015) to Revision A	Page
• Initial release of full version.	1

5 Device Comparison Table

Device	Quick Output Discharge	Reverse Current Blocking	Package (Pin)	Body Size	Pin Pitch
TPS22954	Yes	No	DSQ (10)	2.00 mm x 2.00 mm	0.4 mm
			DQC (10)	2.00 mm x 3.00 mm	0.5 mm
TPS22953	No	Yes	DSQ (10)	2.00 mm x 2.00 mm	0.4 mm
			DQC (10)	2.00 mm x 3.00 mm	0.5 mm

6 Pin Configuration and Functions

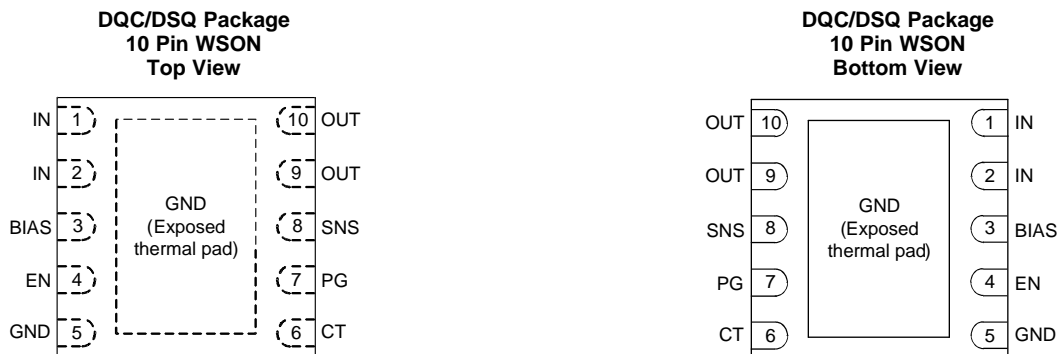

Pin Functions

PIN ⁽¹⁾		I/O	DESCRIPTION
NO.	NAME		
1	IN	I	Switch input. Bypass this input with a ceramic capacitor to GND
2			
3	BIAS	I	Bias pin and power supply to the device
4	EN	I	Active high switch enable/disable input. Also acts as the input UVLO pin. Use external resistor divider to adjust the UVLO level. Do not leave floating.
5	GND	—	Device ground
6	CT	O	V_{OUT} slew rate control. Place ceramic cap from CT to GND to change the V_{OUT} slew rate of the device and limit the inrush current. CT Capacitormust be rated to 25 V or higher
7	PG	O	Power good. This pin is open drain which will pull low when the voltage on EN and/or SNS is below their respective VIL level
8	SNS	I	Sense pin. Use external resistor divider to adjust the power good level. Do not leave floating
9	OUT	O	Switch output
10			
—	Thermal Pad	—	Exposed thermal pad. Tie to GND

(1) Pinout applies to all package versions.

7 Specifications

7.1 Absolute Maximum Ratings

Over operating free-air temperature range (unless otherwise noted) ⁽¹⁾

		MIN	MAX	UNIT
V _{IN}	Input voltage	−0.3	6	V
V _{BIAS}	Bias voltage	−0.3	6	V
V _{OUT}	Output voltage	−0.3	6	V
V _{EN} , V _{SNS} , V _{PG}	EN, SNS, and PG voltage	−0.3	6	V
I _{MAX}	Maximum continuous switch current, T _A = 70°C		5	A
I _{PLS}	Maximum pulsed switch current, pulse < 300 μs, 2% duty cycle		7	A
T _{J,MAX}	Maximum junction temperature	Internally limited ⁽²⁾		
T _{stg}	Storage temperature	−65	150	°C

- (1) Stresses beyond those listed under *Absolute Maximum Ratings* may cause permanent damage to the device. These are stress ratings only, which do not imply functional operation of the device at these or any other conditions beyond those indicated under *Recommended Operating Conditions*. Exposure to absolute-maximum-rated conditions for extended periods may affect device reliability.
- (2) See TSD specification in the [Electrical Characteristics](#) section and [Thermal Considerations](#) section.

7.2 ESD Ratings

		VALUE	UNIT
V _(ESD)	Electrostatic discharge	Human-body model (HBM), per ANSI/ESDA/JEDEC JS-001 ⁽¹⁾	±2000
		Charged-device model (CDM), per JEDEC specification JESD22-C101 ⁽²⁾	±750

- (1) JEDEC document JEP155 states that 500-V HBM allows safe manufacturing with a standard ESD control process. Manufacturing with less than 500-V HBM is possible with the necessary precautions.
- (2) JEDEC document JEP157 states that 250-V CDM allows safe manufacturing with a standard ESD control process. Manufacturing with less than 250-V CDM is possible with the necessary precautions.

7.3 Recommended Operating Conditions

Over operating free-air temperature range (unless otherwise noted)

		MIN	MAX	UNIT
V _{IN}	Input voltage	0.7	V _{BIAS}	V
V _{BIAS}	Bias voltage	2.5	5.7	V
V _{OUT}	Output voltage	0	5.7	V
V _{EN} , V _{SNS} , V _{PG}	EN, SNS, and PG voltage	0	5.7	V
T _A ⁽¹⁾	Operating free-air temperature	−40	105	°C
T _J	Operating junction temperature	−40	125	°C

- (1) In applications where high power dissipation and/or poor package thermal resistance is present, the maximum ambient temperature may have to be derated. Maximum ambient temperature [T_{A(max)}] is dependent on the maximum operating junction temperature [T_{J(max)}], the maximum power dissipation of the device in the application [P_{D(max)}], and the junction-to-ambient thermal resistance of the part/package in the application (θ_{JA}), as given by the following equation: T_{A(max)} = T_{J(max)} − (θ_{JA} × P_{D(max)})

7.4 Thermal Information

THERMAL METRIC ⁽¹⁾		TPS22953/54		UNIT
		DQC (WSON)	DSQ (WSON)	
		10 PINS	10 PINS	
R _{θJA}	Junction-to-ambient thermal resistance	65.2	63.5	°C/W
R _{θJC(top)}	Junction-to-case (top) thermal resistance	73.9	81.6	°C/W
R _{θJB}	Junction-to-board thermal resistance	25.5	34.1	°C/W
Ψ _{JT}	Junction-to-top characterization parameter	2	1.9	°C/W
Ψ _{JB}	Junction-to-board characterization parameter	25.4	34.5	°C/W
R _{θJC(bot)}	Junction-to-case (bottom) thermal resistance	8.5	7.9	°C/W

(1) For more information about traditional and new thermal metrics, see the [Semiconductor and IC Package Thermal Metrics](#) application report.

7.5 Electrical Characteristics

Unless otherwise noted, the specification in the following table applies over the operating ambient temperature $-40\text{ °C} \leq T_A \leq +105\text{ °C}$ and the recommended V_{BIAS} voltage range of 2.5 V to 5.7 V. Typical values are for $T_A = 25\text{ °C}$.

PARAMETER		TEST CONDITIONS	T _A	MIN	TYP	MAX	UNIT
VOLTAGE THRESHOLDS							
V _{EN}	V _{IH} , Rising threshold	V _{IN} = 0.7 V to V _{BIAS}	-40°C to +105°C	650	700	750	mV
	V _{IL} , Falling threshold	V _{IN} = 0.7 V to V _{BIAS}	-40°C to +105°C	560	600	640	mV
V _{SNS}	V _{IH} , Rising threshold	V _{IN} = 0.7 V to V _{BIAS}	-40°C to +105°C	465	515	565	mV
	V _{IL} , Falling threshold	V _{IN} = 0.7 V to V _{BIAS}	-40°C to +105°C	410	455	500	mV
TIMINGS							
t _{BLANK}	Blanking time for EN and SNS	EN or SNS rising	-40°C to +105°C	100			μs
t _{DEGLITCH}	Deglintch time for EN and SNS	EN or SNS falling	-40°C to +105°C	5			μs
t _{DIS}	Output discharge time (TPS22954 only)	C _L = 100 μF	-40°C to +105°C			10	ms
t _{RESTART}	Output restart time	SNS falling	-40°C to +105°C	2			ms
t _{RFB}	Response time for reverse current blocking (TPS22953 only)	V _{OUT} = V _{BIAS} EN falling	-40°C to +105°C	10			μs
THERMAL CHARACTERISTICS							
T _{SD}	Thermal shutdown	Junction temperature rising	—	130	150	170	°C
TSD _{HYS}	Thermal shutdown hysteresis	Junction temperature falling	—	20			°C
REVERSE CURRENT BLOCKING							
I _{RCB,IN}	Input reverse blocking current (TPS22953 only)	V _{OUT} = 5 V, V _{IN} = V _{EN} = 0 V, V _{BIAS} = 0 V to 5.7 V	25°C	0.01		2	μA
			-40°C to +85°C			5	μA
			-40°C to +105°C			11	μA

7.6 Electrical Characteristics— $V_{BIAS} = 5\text{ V}$

Unless otherwise noted, the specification in the following table applies over the operating ambient temperature $-40\text{ °C} \leq T_A \leq +105\text{ °C}$ and $V_{BIAS} = 5\text{ V}$. Typical values are for $T_A = 25\text{ °C}$.

PARAMETER		TEST CONDITIONS		T_A	MIN	TYP	MAX	UNIT
POWER SUPPLIES AND CURRENTS								
$I_{Q, BIAS}$	BIAS quiescent current	$I_{OUT} = 0$, $V_{IN} = 0.7\text{ V}$ to V_{BIAS} , $V_{EN} = 5\text{ V}$		-40 °C to $+85\text{ °C}$	34	45		μA
				-40 °C to $+105\text{ °C}$		50		
$I_{SD, BIAS}$	BIAS shutdown current	$V_{OUT} = 0\text{ V}$, $V_{IN} = 0.7\text{ V}$ to V_{BIAS} , $V_{EN} = 0\text{ V}$ to V_{IL}		-40 °C to $+85\text{ °C}$	5	7		μA
				-40 °C to $+105\text{ °C}$		8		μA
$I_{SD, IN}$	Input shutdown current	$V_{EN} = 0\text{ V}$ to V_{IL} , $V_{OUT} = 0\text{ V}$		$V_{IN} = 5\text{ V}$	-40 °C to $+85\text{ °C}$	0.02	4	μA
					-40 °C to $+105\text{ °C}$		13	
				$V_{IN} = 3.3\text{ V}$	-40 °C to $+85\text{ °C}$	0.01	3	
					-40 °C to $+105\text{ °C}$		10	
				$V_{IN} = 1.8\text{ V}$	-40 °C to $+85\text{ °C}$	0.01	3	
					-40 °C to $+105\text{ °C}$		10	
				$V_{IN} = 1.2\text{ V}$	-40 °C to $+85\text{ °C}$	0.01	2	
					-40 °C to $+105\text{ °C}$		8	
$V_{IN} = 0.7\text{ V}$	-40 °C to $+85\text{ °C}$	0.01	2					
	-40 °C to $+105\text{ °C}$		8					
I_{EN}	EN pin input leakage current	$V_{EN} = 0\text{ V}$ to 5.7 V		-40 °C to $+105\text{ °C}$		0.1	μA	
I_{SNS}	SNS pin input leakage current	$V_{SNS} \leq V_{BIAS}$		-40 °C to $+105\text{ °C}$		0.1	μA	
RESISTANCE CHARACTERISTICS								
R_{ON}	ON-state resistance	$I_{OUT} = -200\text{ mA}$		$V_{IN} = 5\text{ V}$	25°C	14	20	$\text{m}\Omega$
					-40 °C to $+85\text{ °C}$		23	
					-40 °C to $+105\text{ °C}$		24	
				$V_{IN} = 3.3\text{ V}$	25°C	14	20	$\text{m}\Omega$
					-40 °C to $+85\text{ °C}$		23	
					-40 °C to $+105\text{ °C}$		24	
				$V_{IN} = 1.8\text{ V}$	25°C	14	20	$\text{m}\Omega$
					-40 °C to $+85\text{ °C}$		23	
					-40 °C to $+105\text{ °C}$		24	
				$V_{IN} = 1.5\text{ V}$	25°C	14	20	$\text{m}\Omega$
					-40 °C to $+85\text{ °C}$		23	
					-40 °C to $+105\text{ °C}$		24	
				$V_{IN} = 1.2\text{ V}$	25°C	14	20	$\text{m}\Omega$
					-40 °C to $+85\text{ °C}$		23	
					-40 °C to $+105\text{ °C}$		24	
				$V_{IN} = 0.7\text{ V}$	25°C	14	20	$\text{m}\Omega$
					-40 °C to $+85\text{ °C}$		23	
					-40 °C to $+105\text{ °C}$		24	
R_{PD}	Output pulldown resistance (TPS22954 Only)	$V_{IN} = V_{OUT} = V_{BIAS}$, $V_{EN} = 0\text{ V}$		25°C	15	28	Ω	
				-40 °C to $+105\text{ °C}$		30	Ω	

7.7 Electrical Characteristics— $V_{BIAS} = 3.3\text{ V}$

Unless otherwise noted, the specification in the following table applies over the operating ambient temperature $-40\text{ °C} \leq T_A \leq +105\text{ °C}$ and $V_{BIAS} = 3.3\text{ V}$. Typical values are for $T_A = 25\text{ °C}$.

PARAMETER		TEST CONDITIONS		T_A	MIN	TYP	MAX	UNIT	
POWER SUPPLIES AND CURRENTS									
$I_{Q, BIAS}$	BIAS quiescent current	$I_{OUT} = 0$, $V_{IN} = 0.7\text{ V}$ to V_{BIAS} , $V_{EN} = 5\text{ V}$		-40 °C to $+85\text{ °C}$	19	35		μA	
				-40 °C to $+105\text{ °C}$			37		
$I_{SD, BIAS}$	BIAS shutdown current	$V_{OUT} = 0\text{ V}$, $V_{IN} = 0.7\text{ V}$ to V_{BIAS} , $V_{EN} = 0\text{ V}$ to V_{IL}		-40 °C to $+85\text{ °C}$	4	6		μA	
				-40 °C to $+105\text{ °C}$			7	μA	
$I_{SD, IN}$	Input shutdown current	$V_{EN} = 0\text{ V}$ to V_{IL} , $V_{OUT} = 0\text{ V}$		$V_{IN} = 3.3\text{ V}$	-40 °C to $+85\text{ °C}$	0.01	3	μA	
					-40 °C to $+105\text{ °C}$				10
				$V_{IN} = 1.8\text{ V}$	-40 °C to $+85\text{ °C}$	0.01	3		
					-40 °C to $+105\text{ °C}$				10
				$V_{IN} = 1.2\text{ V}$	-40 °C to $+85\text{ °C}$	0.01	2		
					-40 °C to $+105\text{ °C}$				8
				$V_{IN} = 0.7\text{ V}$	-40 °C to $+85\text{ °C}$	0.01	2		
					-40 °C to $+105\text{ °C}$				8
I_{EN}	EN pin input leakage current	$V_{EN} = 0\text{ V}$ to 5.7 V		-40 °C to $+105\text{ °C}$			0.1	μA	
I_{SNS}	SNS pin input leakage current	$V_{SNS} \leq V_{BIAS}$		-40 °C to $+105\text{ °C}$			0.1	μA	
RESISTANCE CHARACTERISTICS									
R_{ON}	ON-state resistance	$I_{OUT} = -200\text{ mA}$		$V_{IN} = 3.3\text{ V}$	25°C	15	21	$\text{m}\Omega$	
					-40 °C to $+85\text{ °C}$				24
					-40 °C to $+105\text{ °C}$				25
				$V_{IN} = 1.8\text{ V}$	25°C	14	20	$\text{m}\Omega$	
					-40 °C to $+85\text{ °C}$				23
					-40 °C to $+105\text{ °C}$				24
				$V_{IN} = 1.5\text{ V}$	25°C	14	20	$\text{m}\Omega$	
					-40 °C to $+85\text{ °C}$				23
					-40 °C to $+105\text{ °C}$				24
				$V_{IN} = 1.2\text{ V}$	25°C	14	20	$\text{m}\Omega$	
					-40 °C to $+85\text{ °C}$				23
					-40 °C to $+105\text{ °C}$				24
$V_{IN} = 0.7\text{ V}$	25°C	14	20	$\text{m}\Omega$					
	-40 °C to $+85\text{ °C}$				23				
	-40 °C to $+105\text{ °C}$				24				
R_{PD}	Output pulldown resistance (TPS22954 Only)	$V_{IN} = V_{OUT} = V_{BIAS}$, $V_{EN} = 0\text{ V}$		25°C	13	28	Ω		
				-40 °C to $+105\text{ °C}$			30	Ω	

7.8 Electrical Characteristics— $V_{BIAS} = 2.5\text{ V}$

Unless otherwise noted, the specification in the following table applies over the operating ambient temperature $-40\text{ °C} \leq T_A \leq +105\text{ °C}$ and $V_{BIAS} = 2.5\text{ V}$. Typical values are for $T_A = 25\text{ °C}$.

PARAMETER		TEST CONDITIONS	T_A	MIN	TYP	MAX	UNIT	
POWER SUPPLIES AND CURRENTS								
$I_{Q, BIAS}$	BIAS quiescent current	$I_{OUT} = 0$, $V_{IN} = 0.7\text{ V}$ to V_{BIAS} , $V_{EN} = 5\text{ V}$	-40 °C to $+85\text{ °C}$	16	25		μA	
			-40 °C to $+105\text{ °C}$			27		
$I_{SD, BIAS}$	BIAS shutdown current	$V_{OUT} = 0\text{ V}$, $V_{IN} = 0.7\text{ V}$ to V_{BIAS} , $V_{EN} = 0\text{ V}$ to V_{IL}	-40 °C to $+85\text{ °C}$	4	5		μA	
			-40 °C to $+105\text{ °C}$			6	μA	
$I_{SD, IN}$	Input shutdown current	$V_{EN} = 0\text{ V}$ to V_{IL} , $V_{OUT} = 0\text{ V}$	$V_{IN} = 2.5\text{ V}$	-40 °C to $+85\text{ °C}$	0.01	3	μA	
				-40 °C to $+105\text{ °C}$				10
			$V_{IN} = 1.8\text{ V}$	-40 °C to $+85\text{ °C}$	0.01	3		
				-40 °C to $+105\text{ °C}$				10
			$V_{IN} = 1.2\text{ V}$	-40 °C to $+85\text{ °C}$	0.01	2		
				-40 °C to $+105\text{ °C}$				8
			$V_{IN} = 0.7\text{ V}$	-40 °C to $+85\text{ °C}$	0.01	2		
				-40 °C to $+105\text{ °C}$				8
I_{EN}	EN pin input leakage current	$V_{EN} = 0\text{ V}$ to 5.7 V	-40 °C to $+105\text{ °C}$			0.1	μA	
I_{SNS}	SNS pin input leakage current	$V_{SNS} \leq V_{BIAS}$	-40 °C to $+105\text{ °C}$			0.1	μA	
RESISTANCE CHARACTERISTICS								
R_{ON}	ON-state resistance	$I_{OUT} = -200\text{ mA}$	$V_{IN} = 2.5\text{ V}$	25°C	16	23	$\text{m}\Omega$	
				-40 °C to $+85\text{ °C}$				26
				-40 °C to $+105\text{ °C}$				27
			$V_{IN} = 1.8\text{ V}$	25°C	15	22	$\text{m}\Omega$	
				-40 °C to $+85\text{ °C}$				25
				-40 °C to $+105\text{ °C}$				26
			$V_{IN} = 1.5\text{ V}$	25°C	15	22	$\text{m}\Omega$	
				-40 °C to $+85\text{ °C}$				25
				-40 °C to $+105\text{ °C}$				26
			$V_{IN} = 1.2\text{ V}$	25°C	15	22	$\text{m}\Omega$	
				-40 °C to 85 °C				24
				-40 °C to $+105\text{ °C}$				25
$V_{IN} = 0.7\text{ V}$	25°C	14	21	$\text{m}\Omega$				
	-40 °C to $+85\text{ °C}$				24			
	-40 °C to $+105\text{ °C}$				25			
R_{PD}	Output pulldown resistance (TPS22954 Only)	$V_{IN} = V_{OUT} = V_{BIAS}$, $V_{EN} = 0\text{ V}$	25°C	12	28	Ω		
			-40 °C to $+105\text{ °C}$			30	Ω	

7.9 Switching Characteristics—CT = 1000 pF

Refer to the timing test circuit in [Figure 51](#) (unless otherwise noted) for references to external components used for the test condition in the switching characteristics table. Switching characteristics shown below are only valid for the power-up sequence where V_{IN} and V_{BIAS} are already in steady state condition before the EN terminal is asserted high.

PARAMETER		TEST CONDITION	MIN	TYP	MAX	UNIT
$V_{IN} = 5\text{ V}$, $V_{EN} = V_{BIAS} = 5\text{ V}$, $T_A = 25^\circ\text{C}$						
t_{ON}	Turnon time	$R_L = 10\ \Omega$, $C_L = 0.1\ \mu\text{F}$, $CT = 1000\ \text{pF}$		1265		μs
t_{OFF}	Turnoff time	$R_L = 10\ \Omega$, $C_L = 0.1\ \mu\text{F}$, $CT = 1000\ \text{pF}$		6		
t_R	V_{OUT} rise time	$R_L = 10\ \Omega$, $C_L = 0.1\ \mu\text{F}$, $CT = 1000\ \text{pF}$		1492		
t_F	V_{OUT} fall time	$R_L = 10\ \Omega$, $C_L = 0.1\ \mu\text{F}$, $CT = 1000\ \text{pF}$		2.2		
t_D	ON delay time	$R_L = 10\ \Omega$, $C_L = 0.1\ \mu\text{F}$, $CT = 1000\ \text{pF}$		519		
$V_{IN} = 2.5\text{ V}$, $V_{EN} = V_{BIAS} = 5\text{ V}$, $T_A = 25^\circ\text{C}$						
t_{ON}	Turnon time	$R_L = 10\ \Omega$, $C_L = 0.1\ \mu\text{F}$, $CT = 1000\ \text{pF}$		813		μs
t_{OFF}	Turnoff time	$R_L = 10\ \Omega$, $C_L = 0.1\ \mu\text{F}$, $CT = 1000\ \text{pF}$		6.1		
t_R	V_{OUT} rise time	$R_L = 10\ \Omega$, $C_L = 0.1\ \mu\text{F}$, $CT = 1000\ \text{pF}$		765		
t_F	V_{OUT} fall time	$R_L = 10\ \Omega$, $C_L = 0.1\ \mu\text{F}$, $CT = 1000\ \text{pF}$		2.2		
t_D	ON delay time	$R_L = 10\ \Omega$, $C_L = 0.1\ \mu\text{F}$, $CT = 1000\ \text{pF}$		430		
$V_{IN} = 0.7\text{ V}$, $V_{EN} = V_{BIAS} = 5\text{ V}$, $T_A = 25^\circ\text{C}$						
t_{ON}	Turnon time	$R_L = 10\ \Omega$, $C_L = 0.1\ \mu\text{F}$, $CT = 1000\ \text{pF}$		476		μs
t_{OFF}	Turnoff time	$R_L = 10\ \Omega$, $C_L = 0.1\ \mu\text{F}$, $CT = 1000\ \text{pF}$		6.2		
t_R	V_{OUT} rise time	$R_L = 10\ \Omega$, $C_L = 0.1\ \mu\text{F}$, $CT = 1000\ \text{pF}$		245		
t_F	V_{OUT} fall time	$R_L = 10\ \Omega$, $C_L = 0.1\ \mu\text{F}$, $CT = 1000\ \text{pF}$		2.1		
t_D	ON delay time	$R_L = 10\ \Omega$, $C_L = 0.1\ \mu\text{F}$, $CT = 1000\ \text{pF}$		353		
$V_{IN} = 2.5\text{ V}$, $V_{EN} = 5\text{ V}$, $V_{BIAS} = 2.5\text{ V}$, $T_A = 25^\circ\text{C}$						
t_{ON}	Turnon time	$R_L = 10\ \Omega$, $C_L = 0.1\ \mu\text{F}$, $CT = 1000\ \text{pF}$		813		μs
t_{OFF}	Turnoff time	$R_L = 10\ \Omega$, $C_L = 0.1\ \mu\text{F}$, $CT = 1000\ \text{pF}$		4.9		
t_R	V_{OUT} rise time	$R_L = 10\ \Omega$, $C_L = 0.1\ \mu\text{F}$, $CT = 1000\ \text{pF}$		765		
t_F	V_{OUT} fall time	$R_L = 10\ \Omega$, $C_L = 0.1\ \mu\text{F}$, $CT = 1000\ \text{pF}$		2.2		
t_D	ON delay time	$R_L = 10\ \Omega$, $C_L = 0.1\ \mu\text{F}$, $CT = 1000\ \text{pF}$		430		
$V_{IN} = 0.7\text{ V}$, $V_{EN} = 5\text{ V}$, $V_{BIAS} = 2.5\text{ V}$, $T_A = 25^\circ\text{C}$						
t_{ON}	Turnon time	$R_L = 10\ \Omega$, $C_L = 0.1\ \mu\text{F}$, $CT = 1000\ \text{pF}$		476		μs
t_{OFF}	Turnoff time	$R_L = 10\ \Omega$, $C_L = 0.1\ \mu\text{F}$, $CT = 1000\ \text{pF}$		6.1		
t_R	V_{OUT} rise time	$R_L = 10\ \Omega$, $C_L = 0.1\ \mu\text{F}$, $CT = 1000\ \text{pF}$		245		
t_F	V_{OUT} fall time	$R_L = 10\ \Omega$, $C_L = 0.1\ \mu\text{F}$, $CT = 1000\ \text{pF}$		2.1		
t_D	ON delay time	$R_L = 10\ \Omega$, $C_L = 0.1\ \mu\text{F}$, $CT = 1000\ \text{pF}$		353		

7.10 Switching Characteristics—CT = 0 pF

Refer to the timing test circuit in [Figure 51](#) (unless otherwise noted) for references to external components used for the test condition in the switching characteristics table. Switching characteristics shown below are only valid for the power-up sequence where V_{IN} and V_{BIAS} are already in steady state condition before the EN terminal is asserted high.

PARAMETER		TEST CONDITION	MIN	TYP	MAX	UNIT
$V_{IN} = 5\text{ V}$, $V_{EN} = V_{BIAS} = 5\text{ V}$, $T_A = 25^\circ\text{C}$						
t_{ON}	Turnon time	$R_L = 10\ \Omega$, $C_L = 0.1\ \mu\text{F}$, $CT = 0\ \text{pF}$		235		μs
t_{OFF}	Turnoff time	$R_L = 10\ \Omega$, $C_L = 0.1\ \mu\text{F}$, $CT = 0\ \text{pF}$		6		
t_R	V_{OUT} rise time	$R_L = 10\ \Omega$, $C_L = 0.1\ \mu\text{F}$, $CT = 0\ \text{pF}$		140		
t_F	V_{OUT} fall time	$R_L = 10\ \Omega$, $C_L = 0.1\ \mu\text{F}$, $CT = 0\ \text{pF}$		2.2		
t_D	ON delay time	$R_L = 10\ \Omega$, $C_L = 0.1\ \mu\text{F}$, $CT = 0\ \text{pF}$		165		
$V_{IN} = 2.5\text{ V}$, $V_{EN} = V_{BIAS} = 5\text{ V}$, $T_A = 25^\circ\text{C}$						
t_{ON}	Turnon time	$R_L = 10\ \Omega$, $C_L = 0.1\ \mu\text{F}$, $CT = 0\ \text{pF}$		200		μs
t_{OFF}	Turnoff time	$R_L = 10\ \Omega$, $C_L = 0.1\ \mu\text{F}$, $CT = 0\ \text{pF}$		6		
t_R	V_{OUT} rise time	$R_L = 10\ \Omega$, $C_L = 0.1\ \mu\text{F}$, $CT = 0\ \text{pF}$		79		
t_F	V_{OUT} fall time	$R_L = 10\ \Omega$, $C_L = 0.1\ \mu\text{F}$, $CT = 0\ \text{pF}$		2.1		
t_D	ON delay time	$R_L = 10\ \Omega$, $C_L = 0.1\ \mu\text{F}$, $CT = 0\ \text{pF}$		160		
$V_{IN} = 0.7\text{ V}$, $V_{EN} = V_{BIAS} = 5\text{ V}$, $T_A = 25^\circ\text{C}$						
t_{ON}	Turnon time	$R_L = 10\ \Omega$, $C_L = 0.1\ \mu\text{F}$, $CT = 0\ \text{pF}$		170		μs
t_{OFF}	Turnoff time	$R_L = 10\ \Omega$, $C_L = 0.1\ \mu\text{F}$, $CT = 0\ \text{pF}$		6		
t_R	V_{OUT} rise time	$R_L = 10\ \Omega$, $C_L = 0.1\ \mu\text{F}$, $CT = 0\ \text{pF}$		32		
t_F	V_{OUT} fall time	$R_L = 10\ \Omega$, $C_L = 0.1\ \mu\text{F}$, $CT = 0\ \text{pF}$		2		
t_D	ON delay time	$R_L = 10\ \Omega$, $C_L = 0.1\ \mu\text{F}$, $CT = 0\ \text{pF}$		154		
$V_{IN} = 2.5\text{ V}$, $V_{EN} = 5\text{ V}$, $V_{BIAS} = 2.5\text{ V}$, $T_A = 25^\circ\text{C}$						
t_{ON}	Turnon time	$R_L = 10\ \Omega$, $C_L = 0.1\ \mu\text{F}$, $CT = 0\ \text{pF}$		200		μs
t_{OFF}	Turnoff time	$R_L = 10\ \Omega$, $C_L = 0.1\ \mu\text{F}$, $CT = 0\ \text{pF}$		6		
t_R	V_{OUT} rise time	$R_L = 10\ \Omega$, $C_L = 0.1\ \mu\text{F}$, $CT = 0\ \text{pF}$		79		
t_F	V_{OUT} fall time	$R_L = 10\ \Omega$, $C_L = 0.1\ \mu\text{F}$, $CT = 0\ \text{pF}$		2.1		
t_D	ON delay time	$R_L = 10\ \Omega$, $C_L = 0.1\ \mu\text{F}$, $CT = 0\ \text{pF}$		160		
$V_{IN} = 0.7\text{ V}$, $V_{EN} = 5\text{ V}$, $V_{BIAS} = 2.5\text{ V}$, $T_A = 25^\circ\text{C}$						
t_{ON}	Turnon time	$R_L = 10\ \Omega$, $C_L = 0.1\ \mu\text{F}$, $CT = 0\ \text{pF}$		170		μs
t_{OFF}	Turnoff time	$R_L = 10\ \Omega$, $C_L = 0.1\ \mu\text{F}$, $CT = 0\ \text{pF}$		6		
t_R	V_{OUT} rise time	$R_L = 10\ \Omega$, $C_L = 0.1\ \mu\text{F}$, $CT = 0\ \text{pF}$		32		
t_F	V_{OUT} fall time	$R_L = 10\ \Omega$, $C_L = 0.1\ \mu\text{F}$, $CT = 0\ \text{pF}$		2		
t_D	ON delay time	$R_L = 10\ \Omega$, $C_L = 0.1\ \mu\text{F}$, $CT = 0\ \text{pF}$		154		

7.11 Typical DC Characteristics

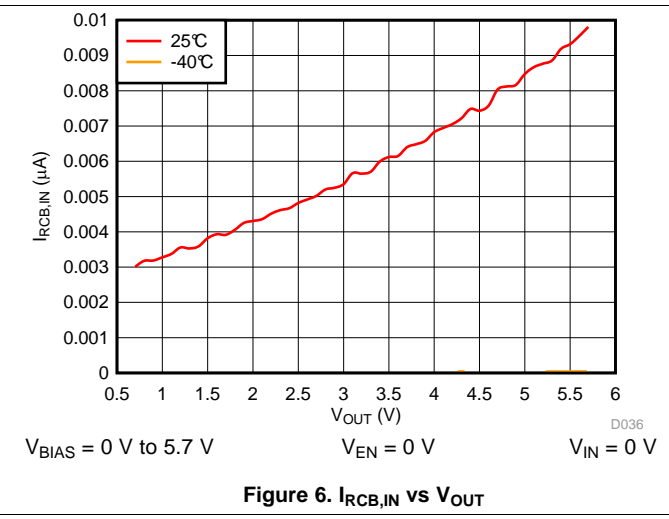
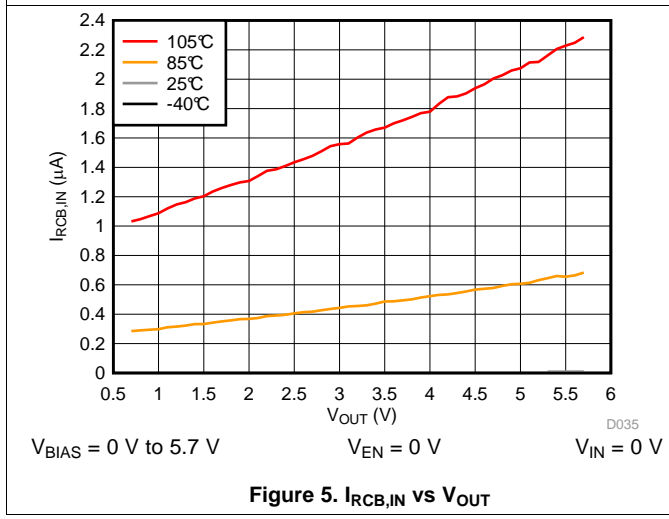
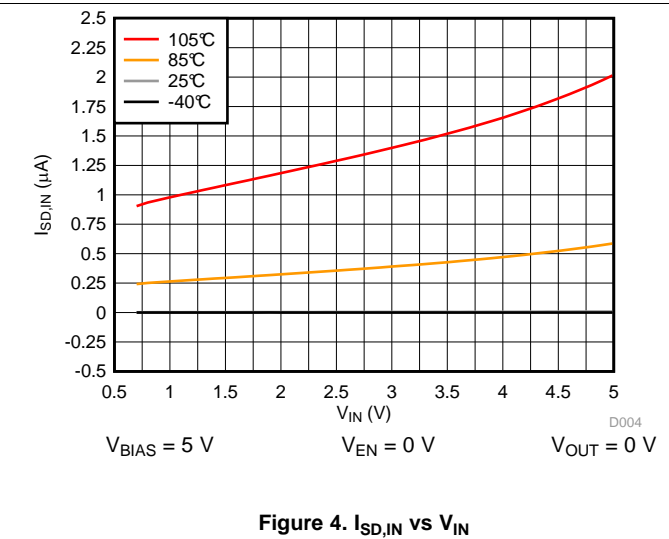
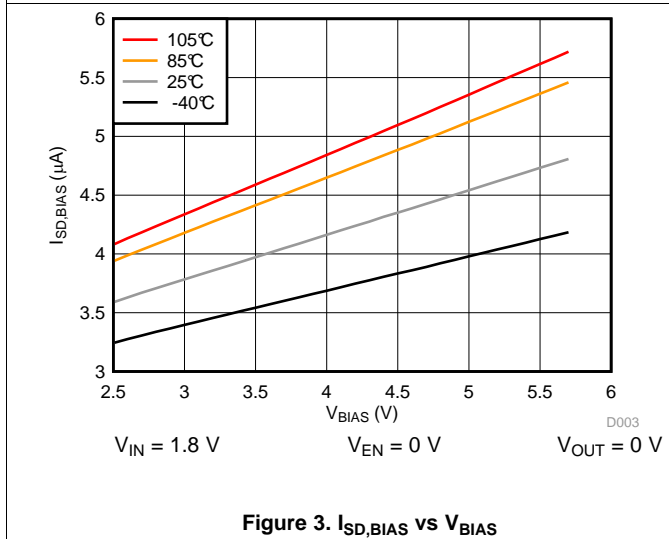
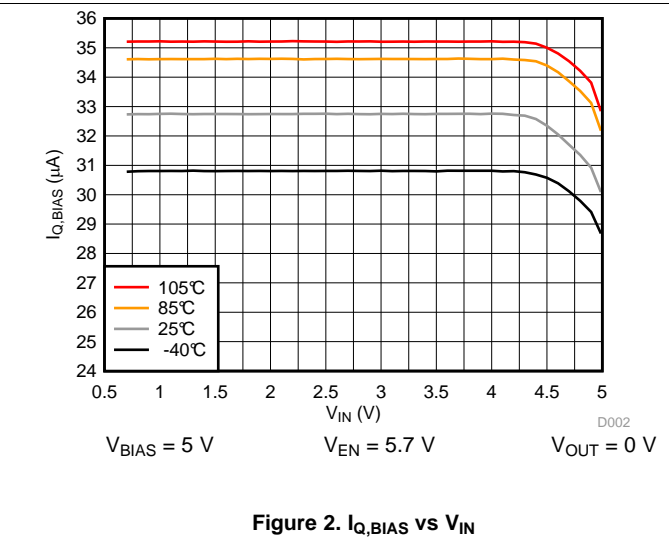
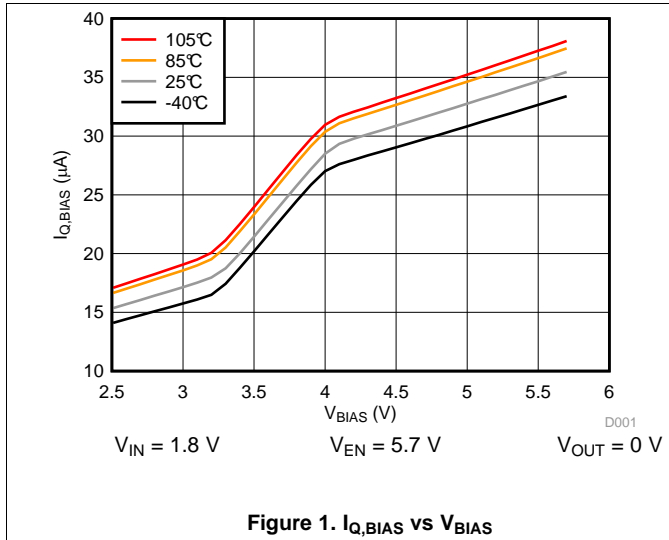

Typical DC Characteristics (continued)

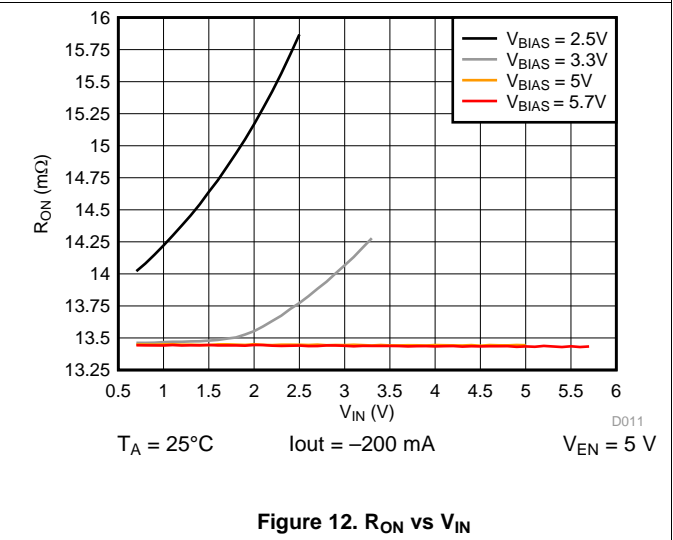
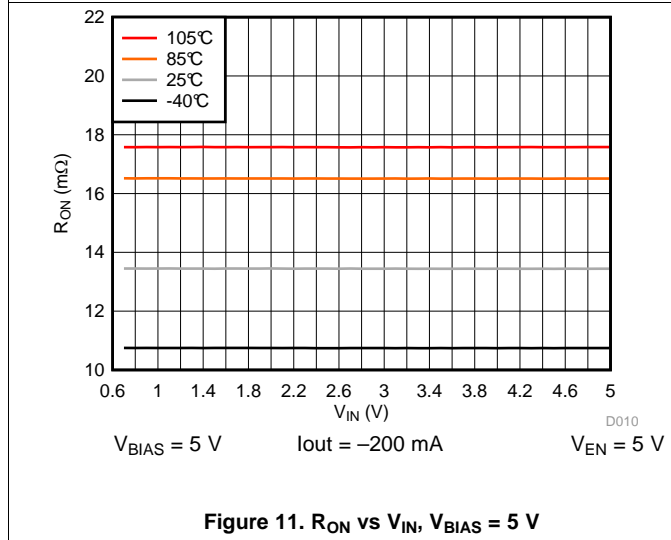
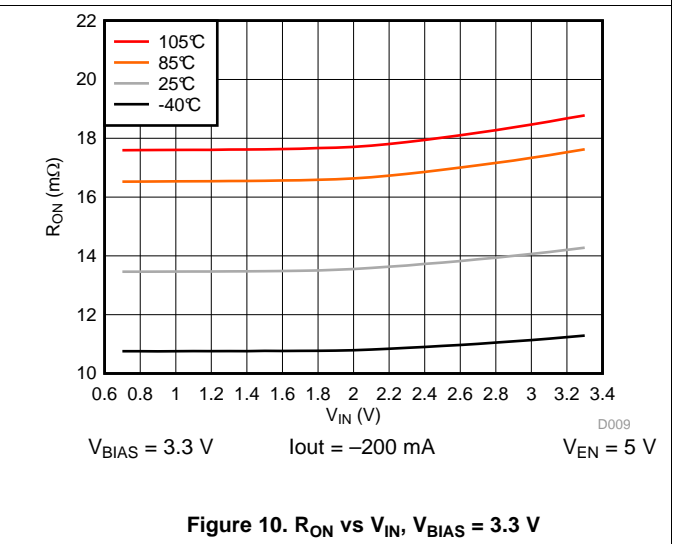
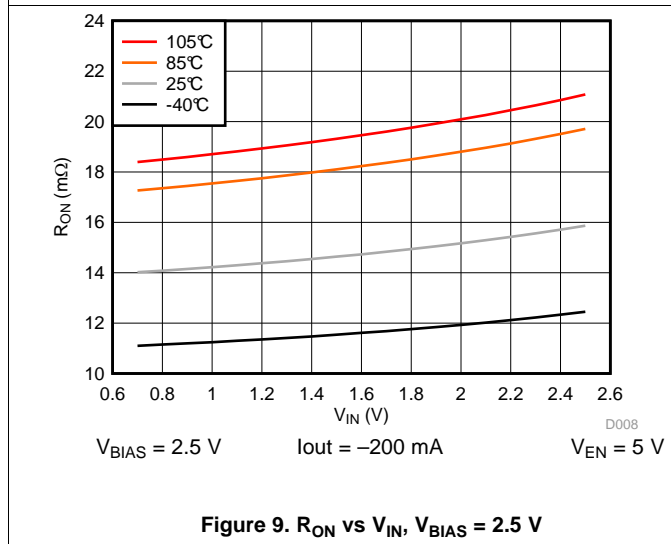
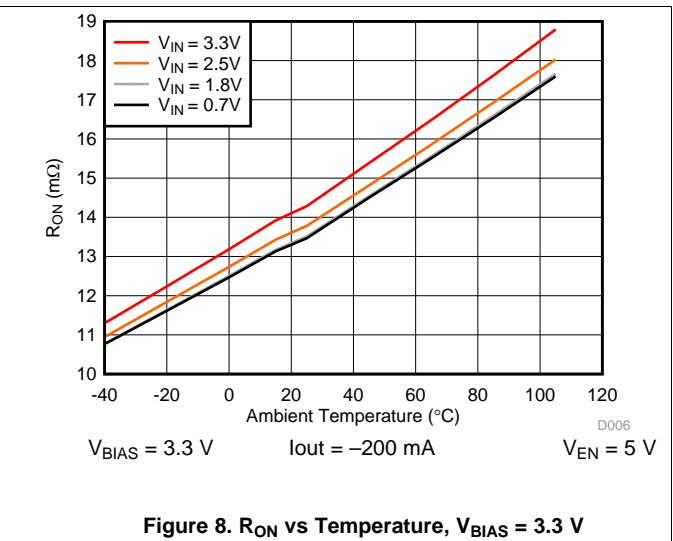
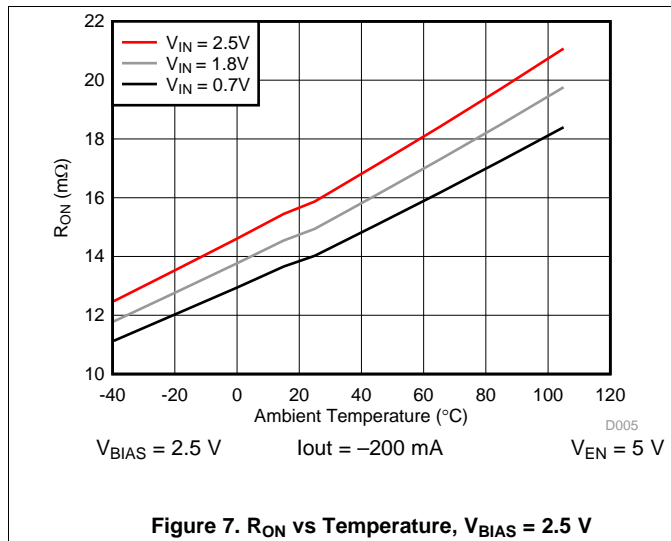

Typical DC Characteristics (continued)

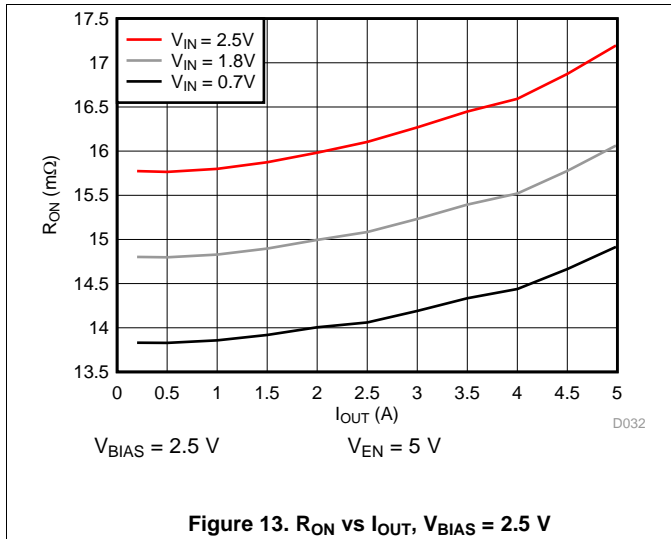

Figure 13. RON vs IOUT, VBIAS = 2.5 V

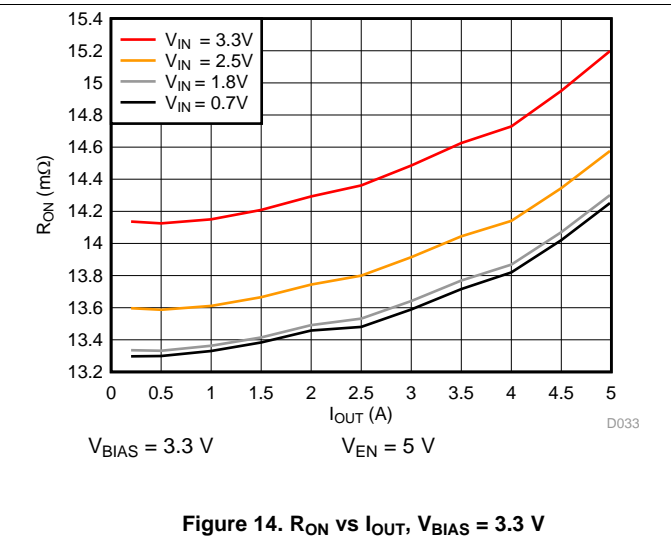

Figure 14. RON vs IOUT, VBIAS = 3.3 V

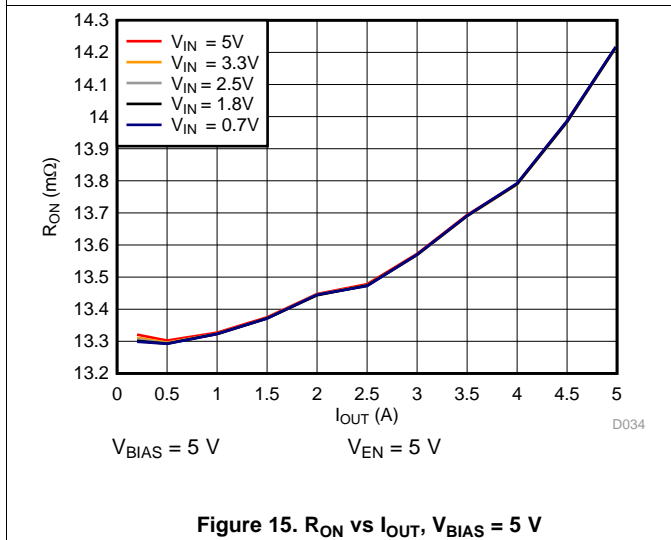

Figure 15. RON vs IOUT, VBIAS = 5 V

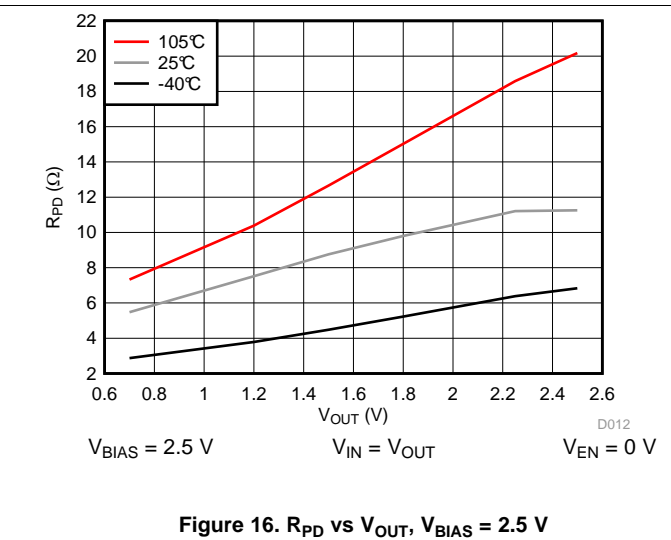

Figure 16. RPD vs VOUT, VBIAS = 2.5 V

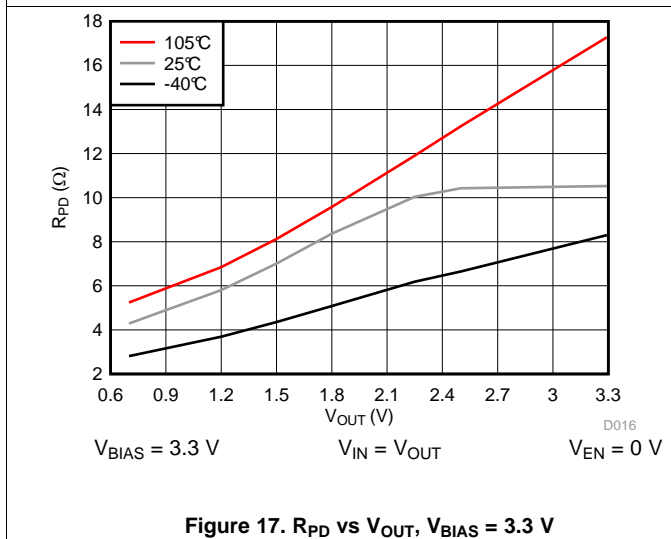

Figure 17. RPD vs VOUT, VBIAS = 3.3 V

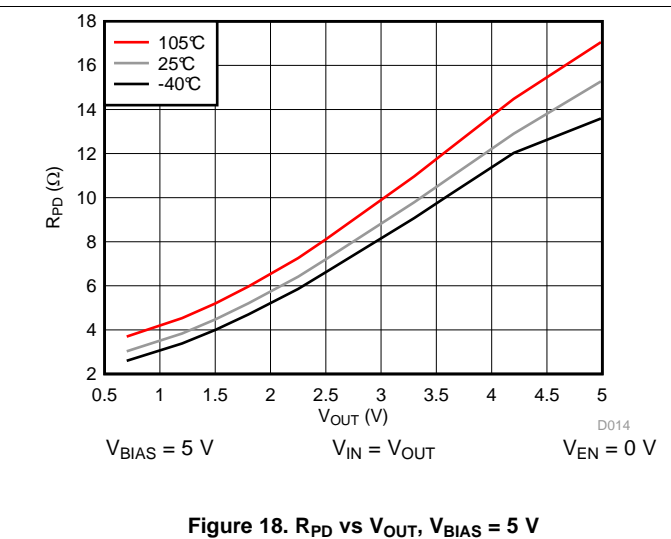
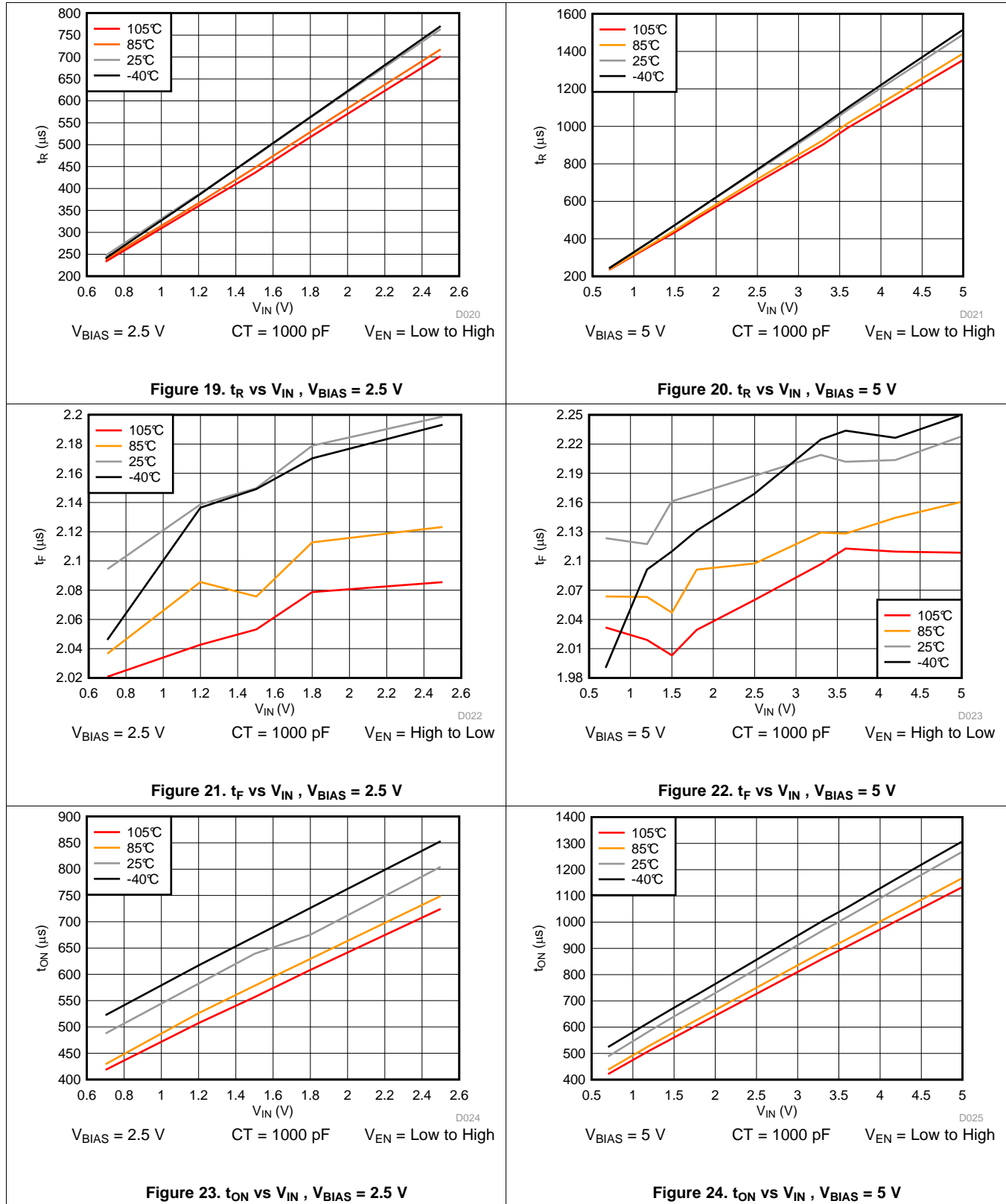
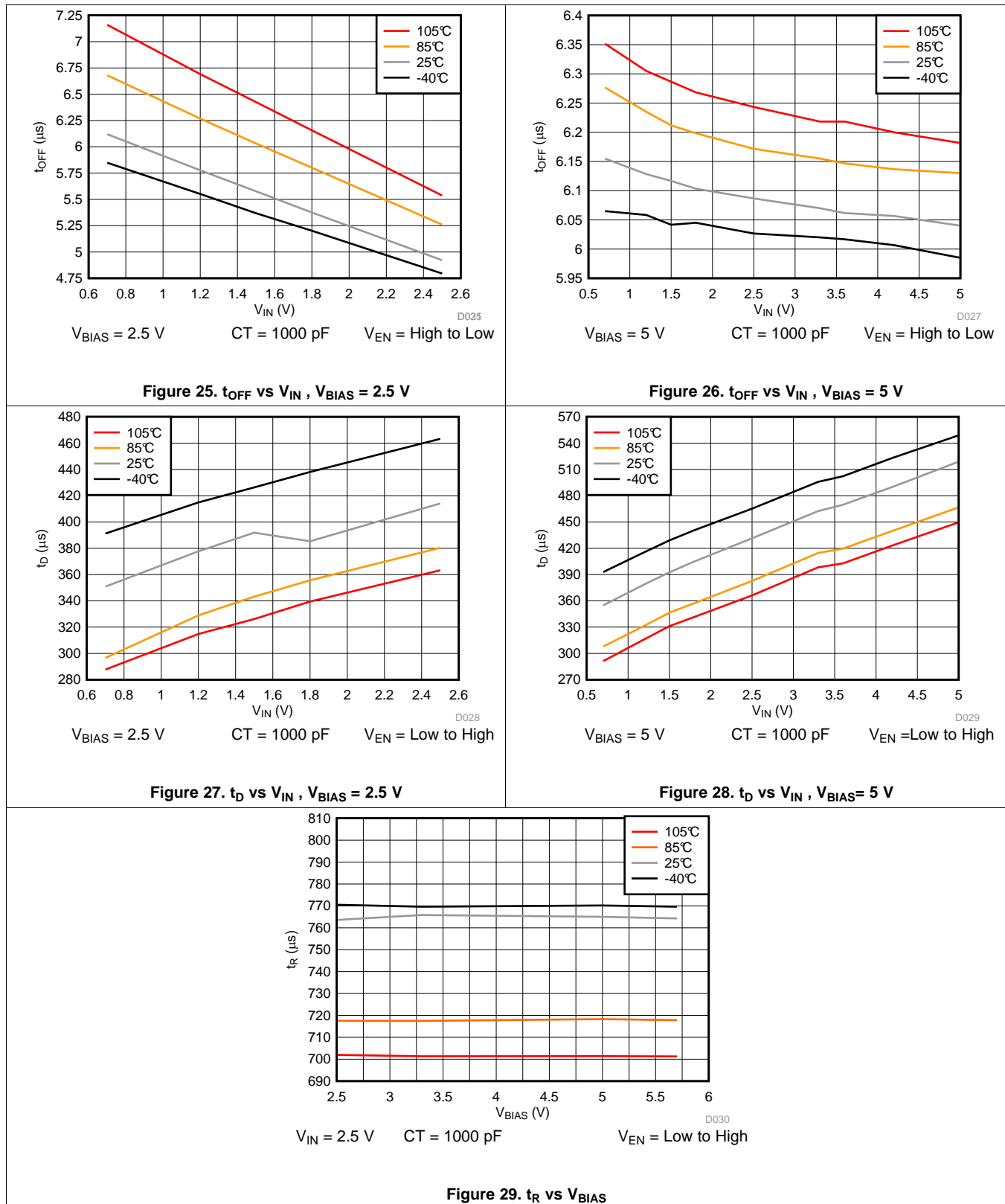

Figure 18. RPD vs VOUT, VBIAS = 5 V

7.12 Typical Switching Characteristics



Typical Switching Characteristics (continued)



Typical Switching Characteristics (continued)

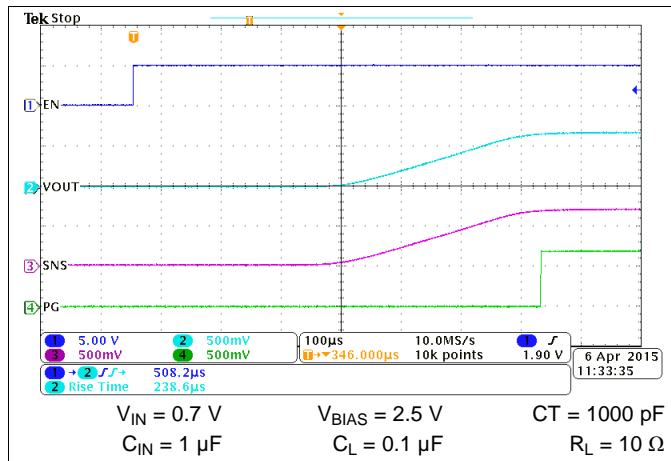

Figure 30. Turnon Waveform, $V_{BIAS} = 2.5\text{ V}$

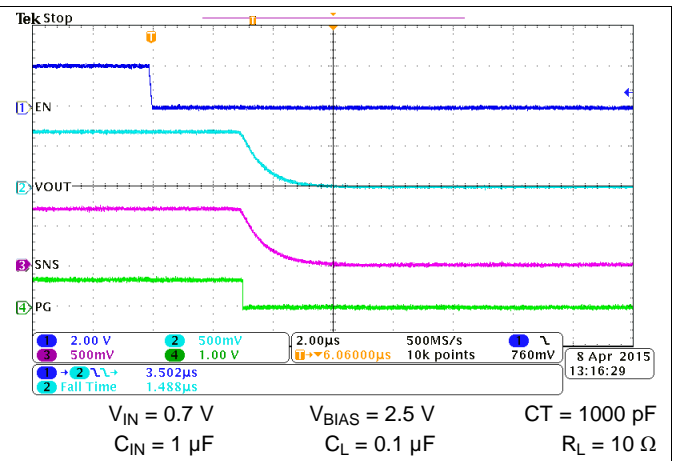

Figure 31. Turnoff Waveform, $V_{BIAS} = 2.5\text{ V}$

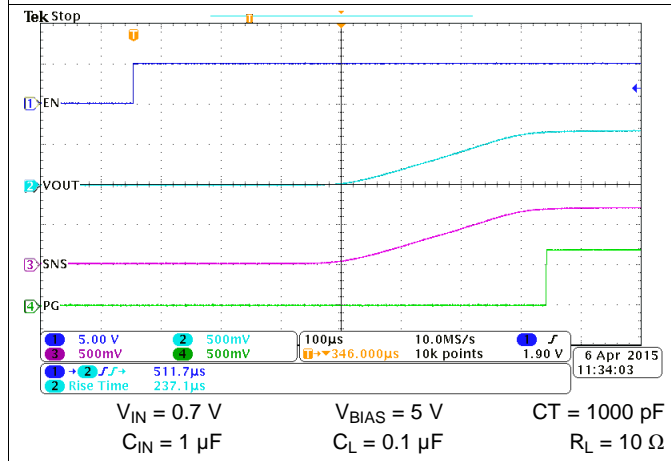

Figure 32. Turnon Waveform, $V_{BIAS} = 5\text{ V}$

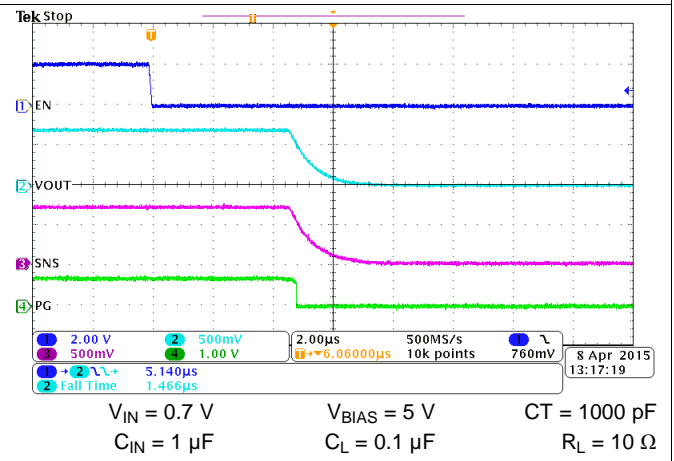

Figure 33. Turnoff Waveform, $V_{BIAS} = 5\text{ V}$

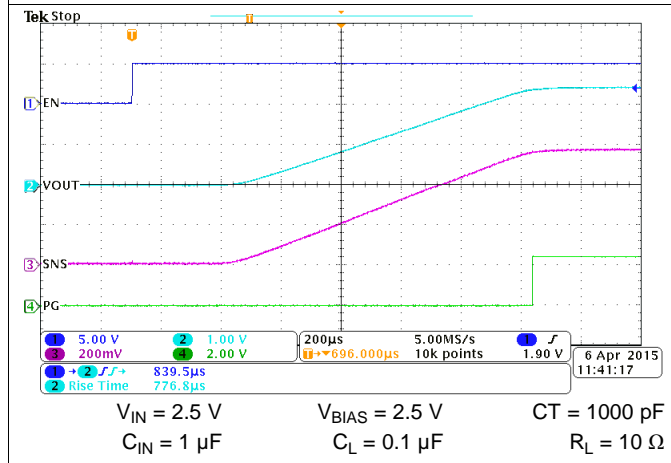

Figure 34. Turnon Waveform, $V_{BIAS} = 2.5\text{ V}$

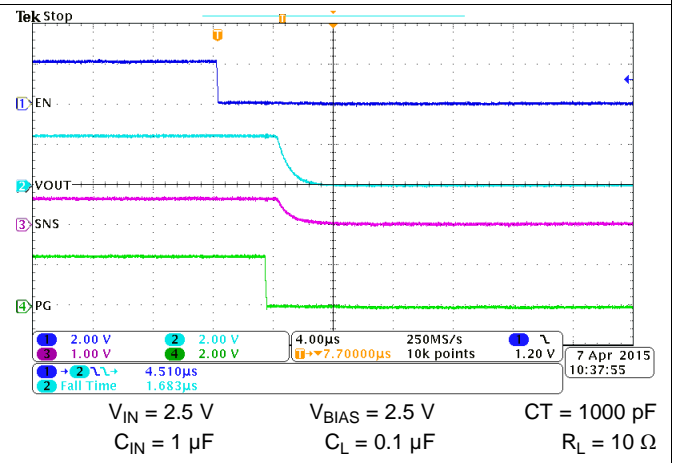

Figure 35. Turnoff Waveform, $V_{BIAS} = 2.5\text{ V}$

Typical Switching Characteristics (continued)

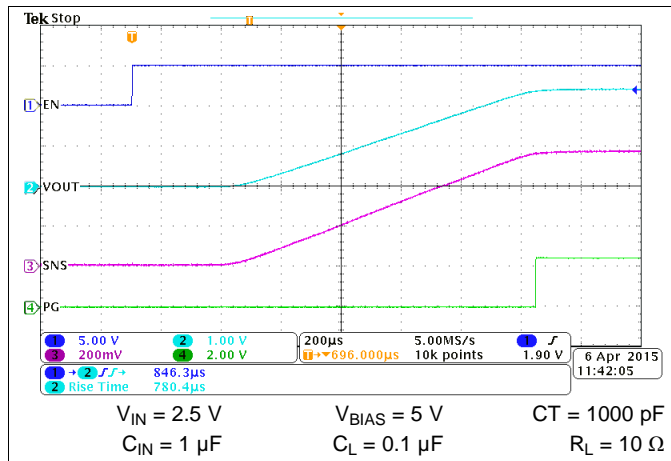

Figure 36. Turnon Waveform, $V_{BIAS} = 5\text{ V}$

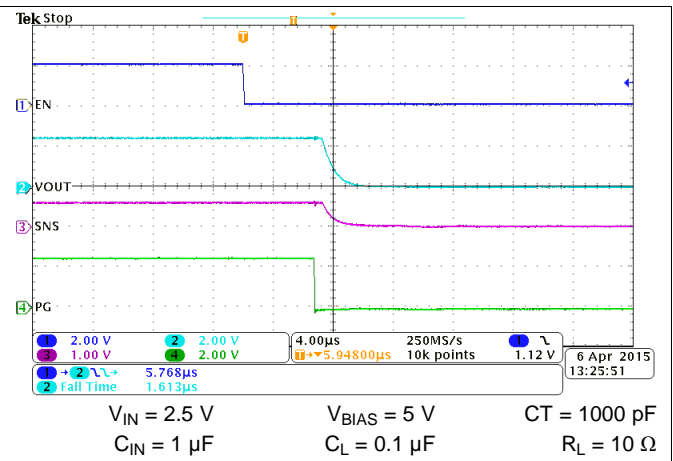

Figure 37. Turnoff Waveform, $V_{BIAS} = 5\text{ V}$

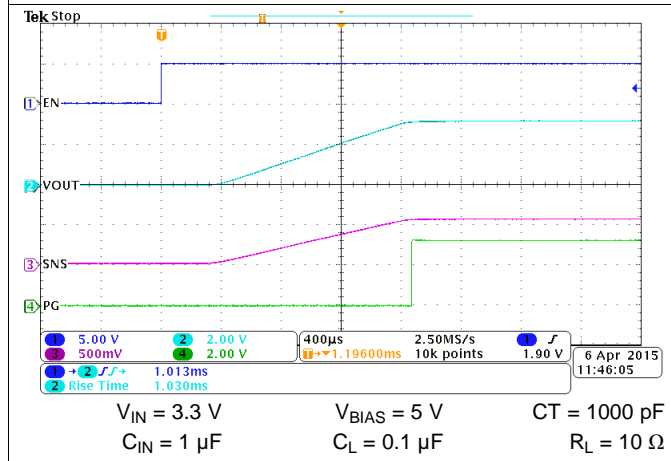

Figure 38. Turnon Waveform, $V_{BIAS} = 5\text{ V}$

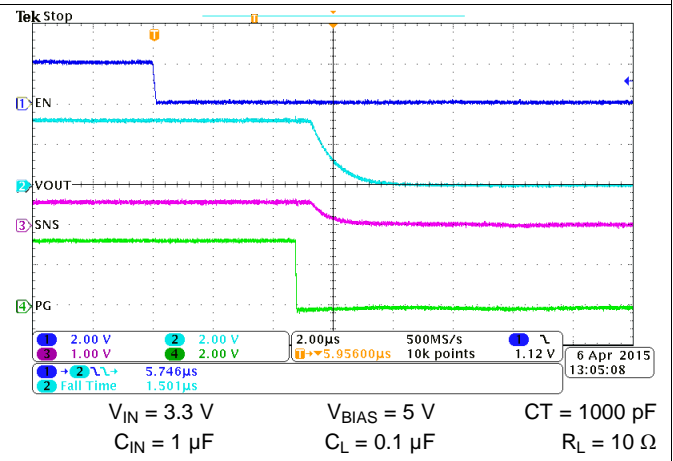

Figure 39. Turnoff Waveform, $V_{BIAS} = 5\text{ V}$

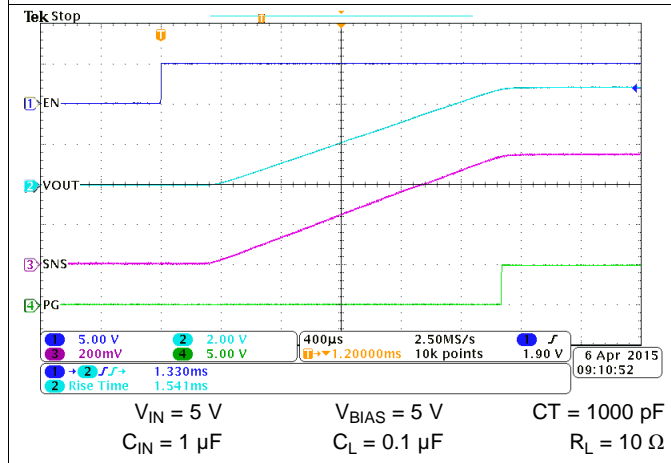

Figure 40. Turnon Waveform, $V_{BIAS} = 5\text{ V}$

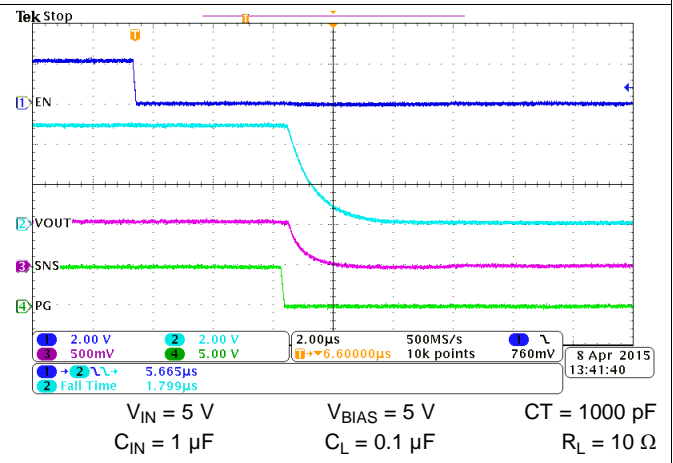
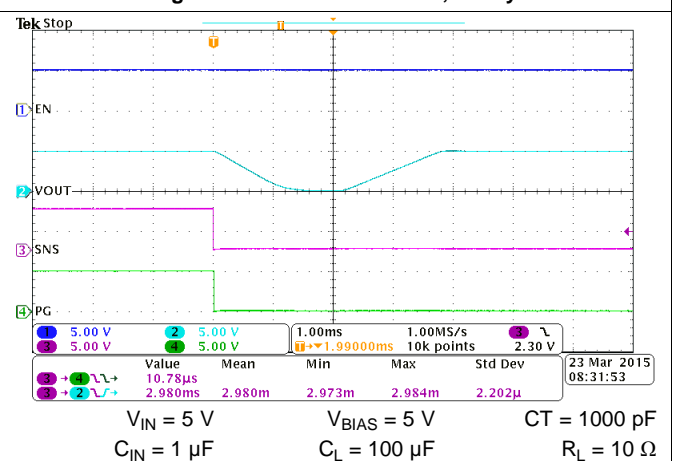
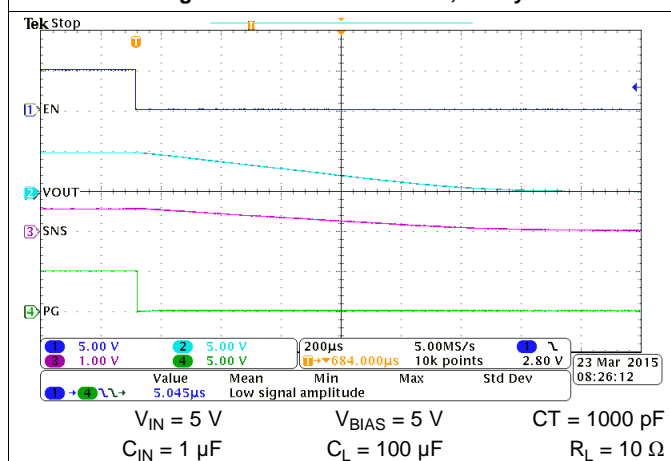
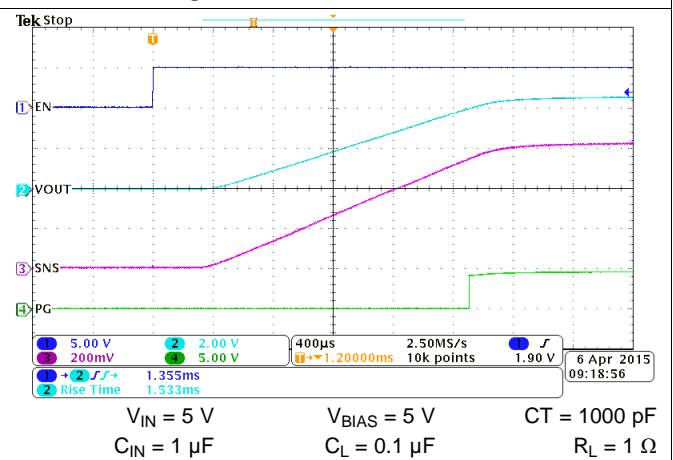
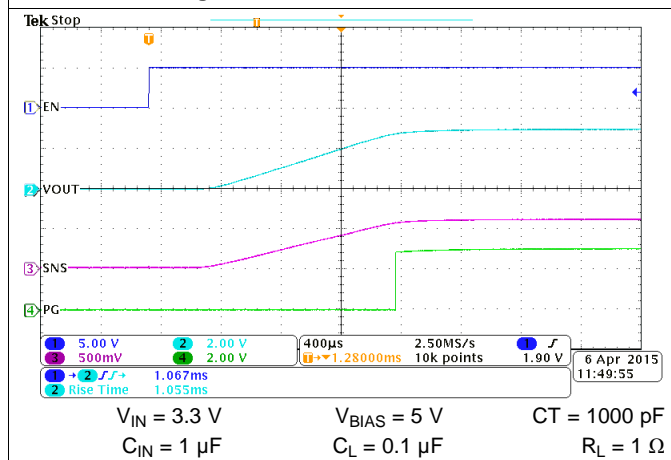
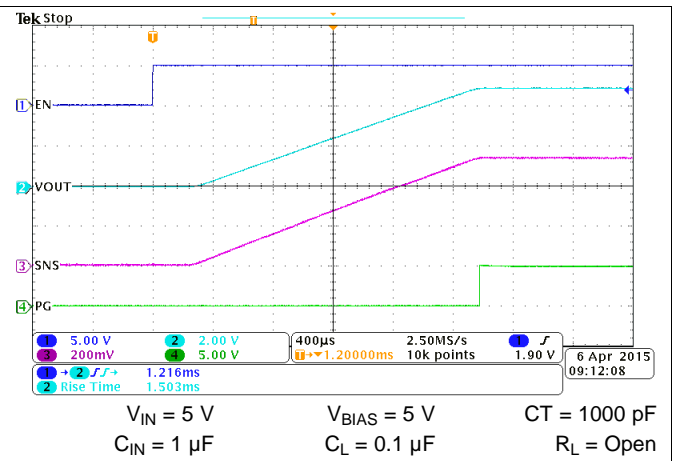
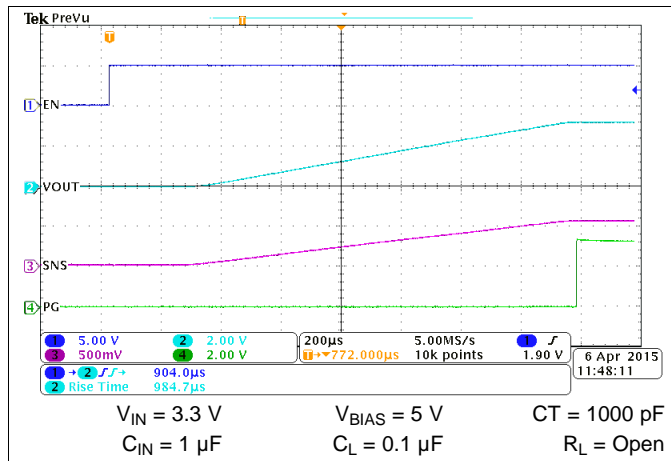
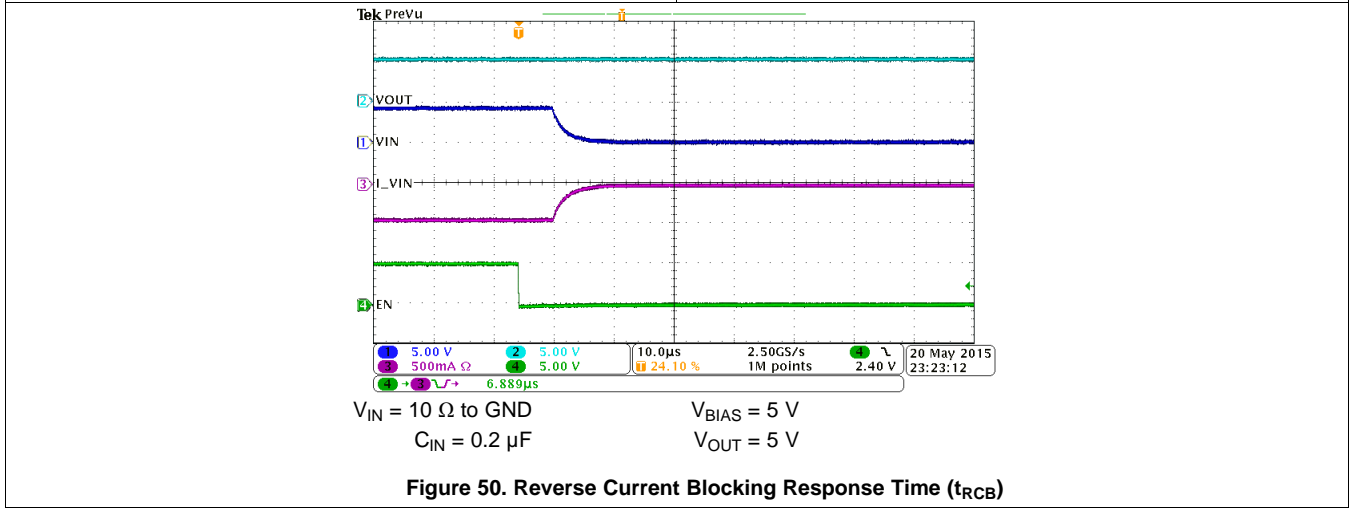
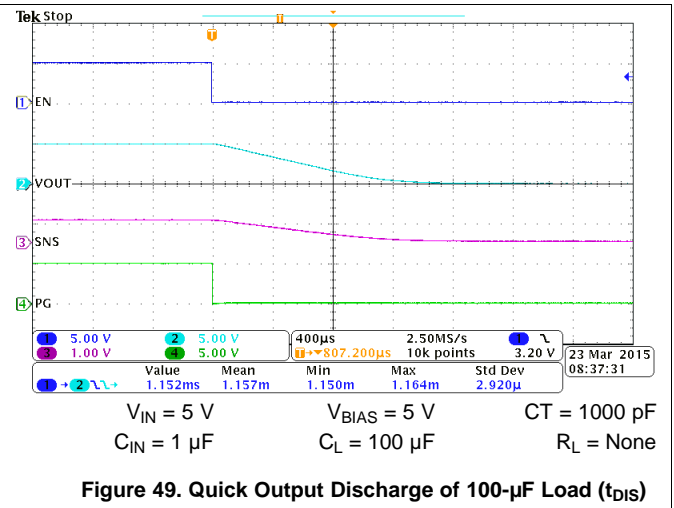
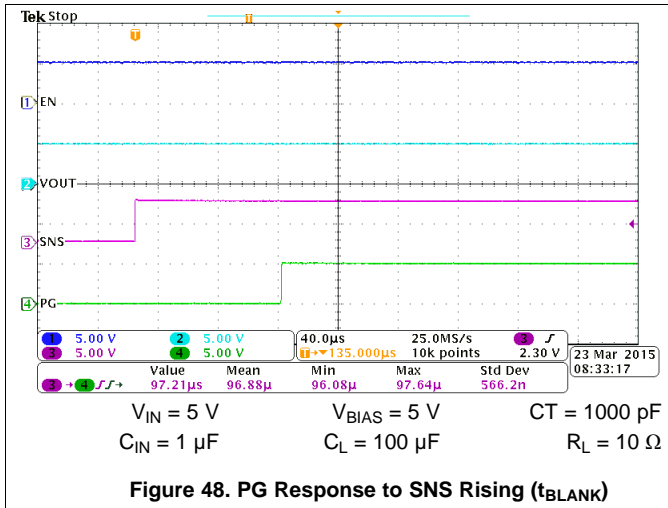

Figure 41. Turnoff Waveform, $V_{BIAS} = 5\text{ V}$

Typical Switching Characteristics (continued)



Typical Switching Characteristics (continued)



8 Parameter Measurement Information

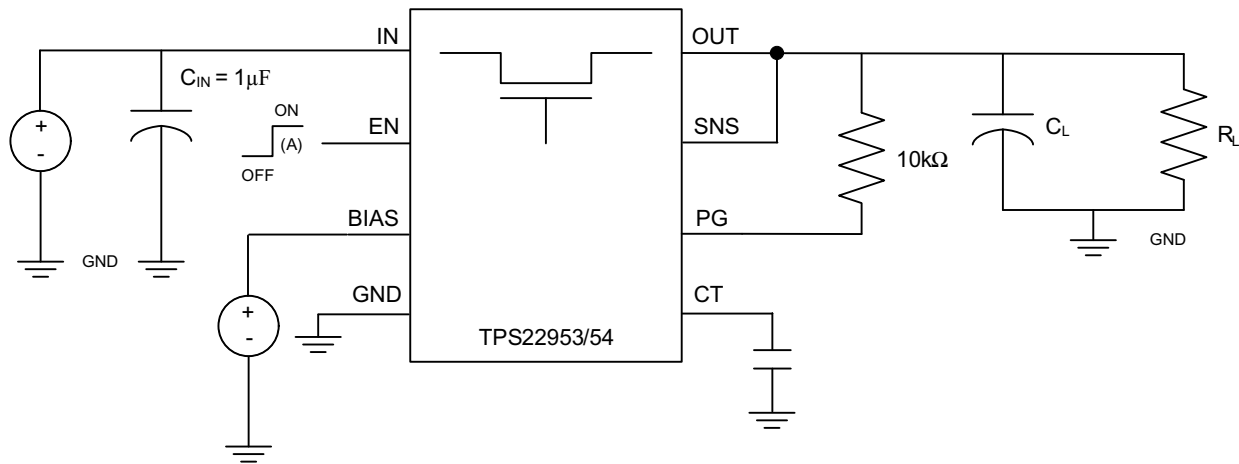

A. Rise and fall times of the control signal is 100 ns.

Figure 51. Timing Test Circuit

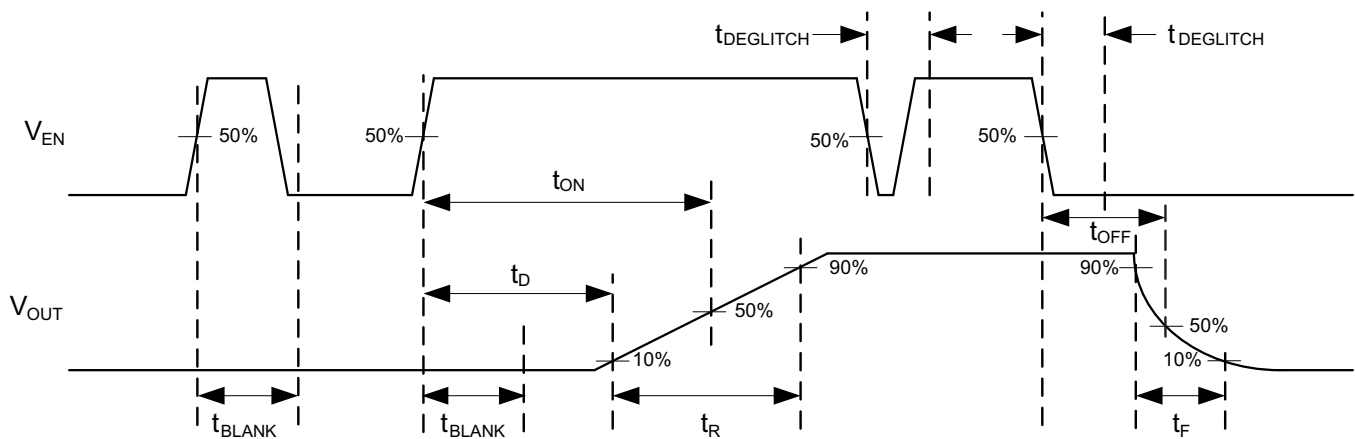

Figure 52. Timing Waveforms

9 Detailed Description

9.1 Overview

The TPS22953/4 are 5.7-V, 5-A load switches in 10-pin SON packages. To reduce voltage drop for low voltage, high current rails the device implements a low resistance N-channel MOSFET, which reduces the drop out voltage through the device at high currents. The integrated adjustable undervoltage lockout (UVLO) and adjustable power good (PG) threshold provides voltage monitoring as well as robust power sequencing.

The adjustable rise time control of the device greatly reduces inrush current for a wide variety of bulk load capacitances, thereby reducing or eliminating power supply droop. The switch is independently controlled by an on and off input (EN), which is capable of interfacing directly with low-voltage control signals. A 15- Ω on-chip load resistor is integrated into the device for output quick discharge when switch is turned off.

During shutdown, the device has very low leakage currents, thereby reducing unnecessary leakages for downstream modules during standby. Integrated power monitoring functionality, control logic, driver, power supply, and output discharge FET eliminates the need for any external components, which reduces solution size and BOM count.

9.2 Functional Block Diagram

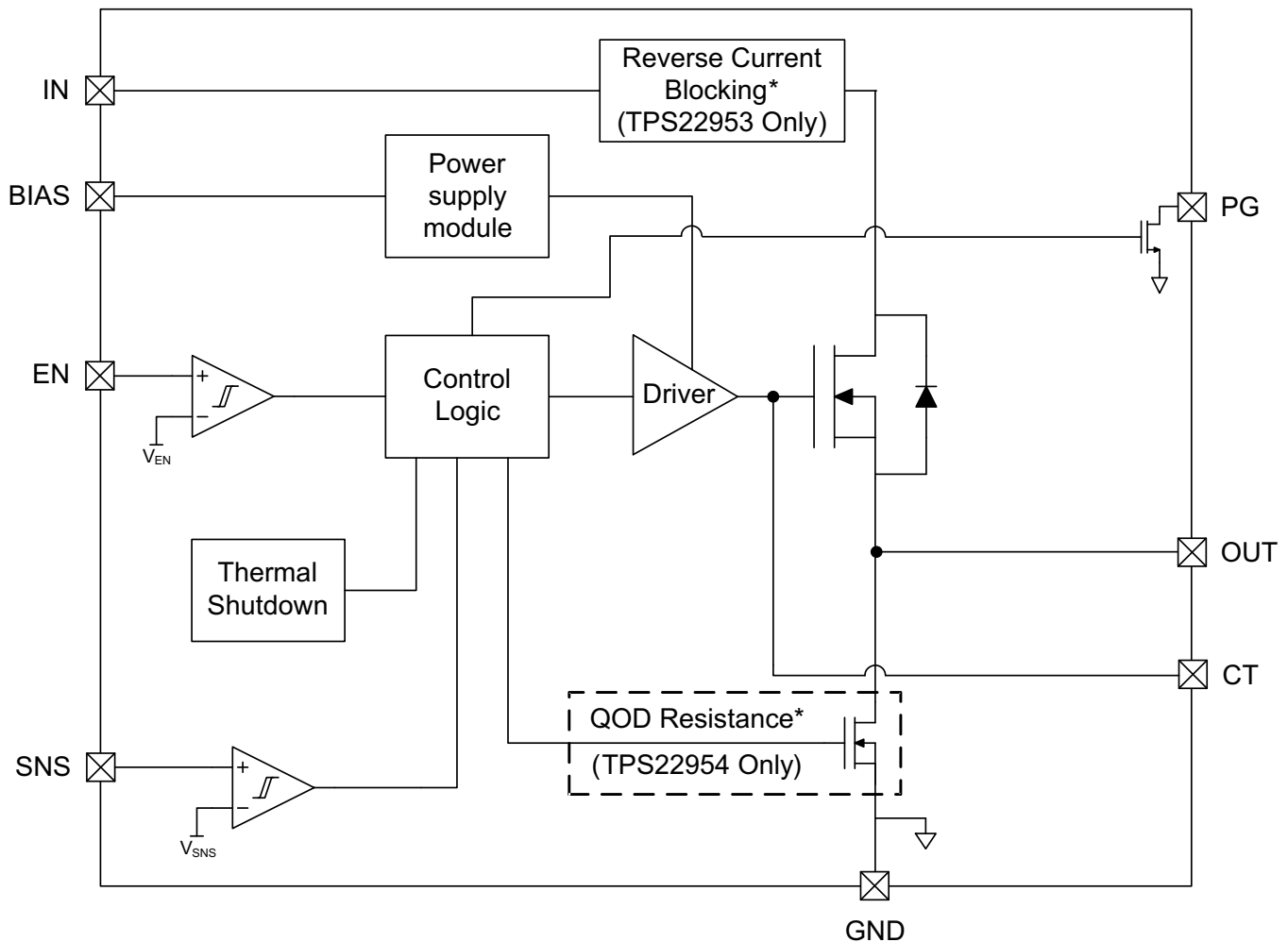

(*) Only active when the switch is disabled.

9.3 Feature Description

9.3.1 On and Off Control (EN pin)

The EN pin controls the state of the switch. When the voltage on EN has exceeded $V_{IH,EN}$ the switch is enabled. When EN goes below $V_{IL,EN}$ the switch is disabled.

The EN pin has a blanking time of t_{BLANK} on the rising edge once the $V_{IH,EN}$ threshold has been exceeded. It also has a de-glitch time of $t_{DEGLITCH}$ when the voltage has gone below $V_{IL,EN}$.

The EN pin can also be configured via an external resistor divider to monitor a voltage signal for input UVLO. See [Equation 1](#) and [Figure 53](#) on how to configure the EN pin for input UVLO.

$$V_{IH,EN} = V_{IN} \times \frac{R_{EN2}}{R_{EN1} + R_{EN2}}$$

where

- $V_{IH,EN}$ is the rising threshold of the EN pin (see the [Electrical Characteristics](#) table)
- V_{IN} is the input voltage being monitored (this could be V_{IN} , V_{BIAS} , or an external power supply)
- R_{EN1} , R_{EN2} is the resistor divider values

(1)

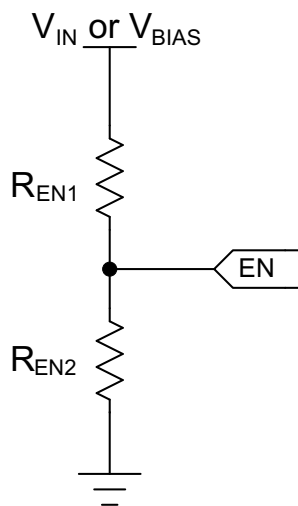

Figure 53. Resistor Divider (EN Pin)

Feature Description (continued)

9.3.2 Voltage Monitoring (SNS Pin)

The SNS pin of the device can be used to monitor the output voltage of the device or another voltage rail. The pin can be configured with an external resistor divider to set the desired trip point for the voltage being monitored or be tied to OUT directly. If the voltage on the SNS pin exceeds $V_{IH,SNS}$, the voltage being monitored on the SNS pin is considered to be valid high. The voltage on the SNS pin must be greater than $V_{IH,SNS}$ for at least t_{BLANK} before PG is asserted high. If the voltage on the SNS pin goes below $V_{IL,SNS}$, then the switch powers cycle (i.e., the switch is disabled and re-enabled). For proper functionality of the device, this pin must not be left floating. If a resistor divider is not being used for voltage sensing, this pin can be tied directly to V_{OUT} .

The SNS pin has a blanking time of t_{BLANK} on the rising edge once the $V_{IH,SNS}$ threshold has been exceeded. It has a de-glitch time of $t_{DEGLITCH}$ when the voltage has gone below $V_{IL,SNS}$.

See [Equation 2](#) and [Figure 54](#) on how to configure the SNS pin for voltage monitoring.

$$V_{IH,SNS} = V_{OUT} \times \frac{R_{SNS2}}{R_{SNS1} + R_{SNS2}}$$

where

- $V_{IH,SNS}$ is the the rising threshold of the SNS pin (see [Electrical Characteristics](#) table)
- V_{OUT} is the voltage on the OUTpin
- R_{SNS1} , R_{SNS2} is the resistor divider values

(2)

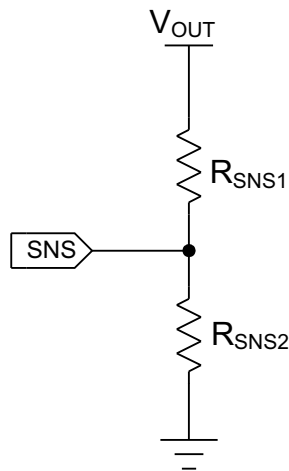

Figure 54. Voltage Divdier (SNS Pin)

Feature Description (continued)

9.3.3 Power Good (PG Pin)

The PG pin is only asserted high when the voltage on EN has exceeded $V_{IH,EN}$ and the voltage on SNS has exceeded $V_{IH,SNS}$. There is a t_{BLANK} time, typically 100 μ s, between the SNS voltage exceeding $V_{IH,SNS}$ and PG being asserted high. If the voltage on EN goes below $V_{IL,EN}$ or the voltage on SNS goes below $V_{IL,SNS}$, PG is deasserted. There is a $t_{DEGLITCH}$ time, typically 5 μ s, between the EN voltage or SNS voltage going below their respective V_{IL} levels and PG being pulled low.

PG is an open drain pin and must be pulled up with a pull-up resistor. Be sure to never exceed the maximum operating voltage on this pin. If PG is not being used in the application, tie it to GND for proper device functionality.

For proper PG operation, the BIAS voltage must be within the recommended operating range. In systems that are very sensitive to noise or have long PG traces, it is recommended to add a small capacitance from PG to GND for decoupling.

9.3.4 Supervisor Fault Detection and Automatic Restart

The falling edge of the SNS pin below $V_{IL,SNS}$ is considered a fault case and causes the load switch to be disabled for $t_{RESTART}$ (typically 2 ms). After the $t_{RESTART}$ time, the switch is automatically re-enabled as long as EN is still above $V_{IH,EN}$. In the case the SNS pin is being used to monitor V_{OUT} or a downstream voltage, the restart helps to protect against excessive over-current if there is a quick short to GND. See [Figure 55](#).

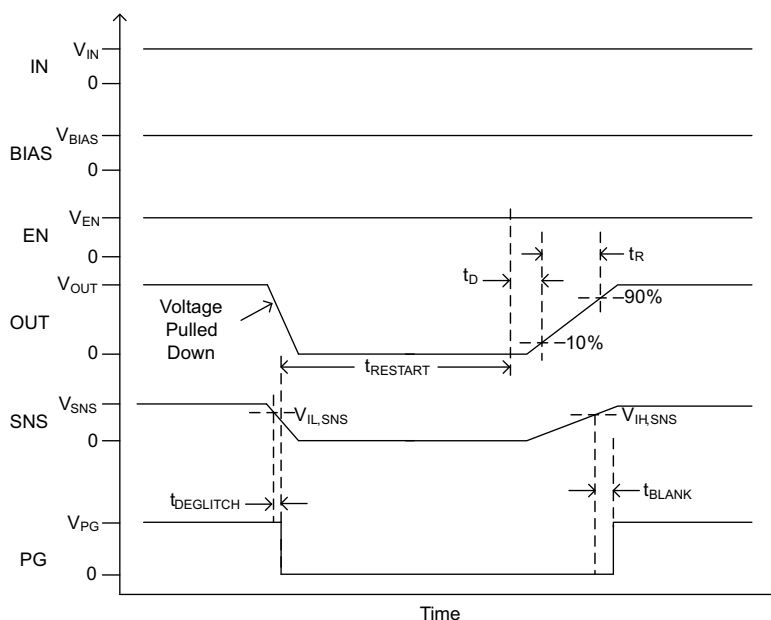

Figure 55. Automatic Restart after Quick Short to GND

Feature Description (continued)

9.3.5 Manual Restart

The falling edge of the SNS pin below $V_{IL,SNS}$ is considered a fault case and causes the load switch to be disabled for $t_{RESTART}$ (typically 2 ms). The SNS pin can be driven by an MCU to manually reset the load switch. After the $t_{RESTART}$ time, the switch is automatically re-enabled as long as EN is still above $V_{IH,EN}$, even if SNS is held low. The PG pin stays low until the switch is re-enabled and the SNS pin rises above $V_{IH,SNS}$. See Figure 56.

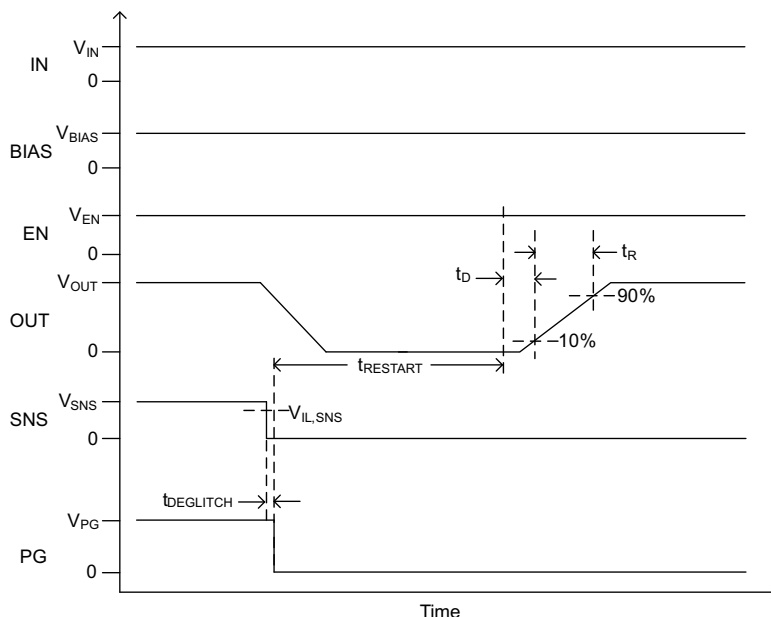

Figure 56. Manual Restart (SNS Held Low)

If the SNS pin is brought above $V_{IH,SNS}$ within the $t_{RESTART}$ time, the switch still waits to re-enable. The PG pin also stays low until t_{BLANK} after switch is re-enabled. In this case, PG indicates when the switch is enabled and capable of being reset again. See Figure 57.

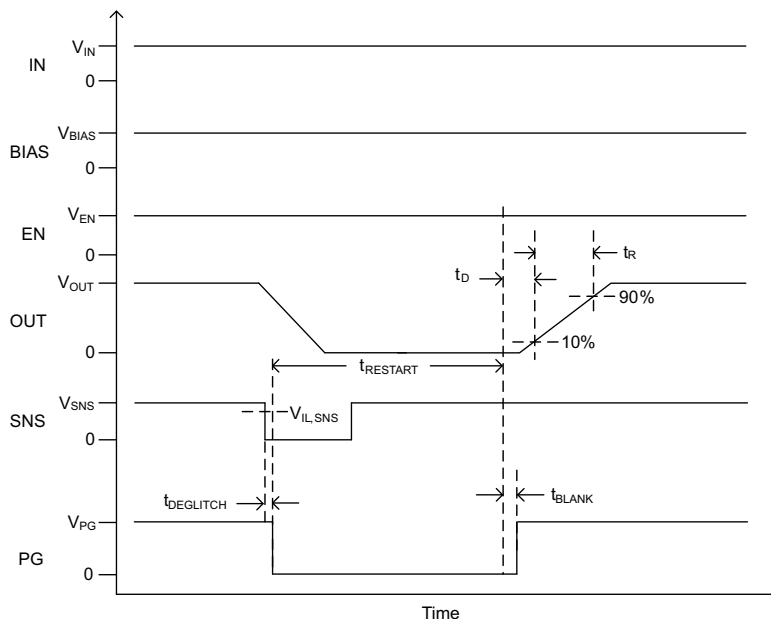

Figure 57. Manual Restart (SNS Toggled Low to High)

Feature Description (continued)

9.3.6 Thermal Shutdown

If the junction temperature of the device exceeds T_{SD} , the switch is disabled. The device is enabled once the junction temperature drops by TSD_{HYS} as long as EN is still greater than $V_{IH,EN}$.

9.3.7 Reverse Current Blocking (TPS22953 Only)

When the switch is disabled (either by de-asserting EN or SNS, triggering thermal shutdown, or losing power), the reverse current blocking (RCB) feature of the device is engaged within t_{RCB} , typically 10 μs . Once the RCB is engaged, the reverse current from the OUT pin to the IN pin is limited to $I_{RCB,IN}$, typically 0.01 μA .

9.3.8 Quick Output Discharge (QOD) (TPS22954 Only)

The quick output discharge (QOD) transistor is engaged indefinitely whenever the switch is disabled and the recommended V_{BIAS} voltage is met. During this state, the QOD resistance (R_{PD}) discharges V_{OUT} to GND. It is not recommended to apply a continuous DC voltage to OUT when the device is disabled.

The QOD transistor can remain active for a short period of time even after V_{BIAS} loses power. This brief period of time is defined as t_{DIS} . For best results, it is recommended the device get disabled before V_{BIAS} goes below the minimum recommended voltage. The waveform in [Figure 58](#) shows the behaviour when power is applied and then removed in a typical application.

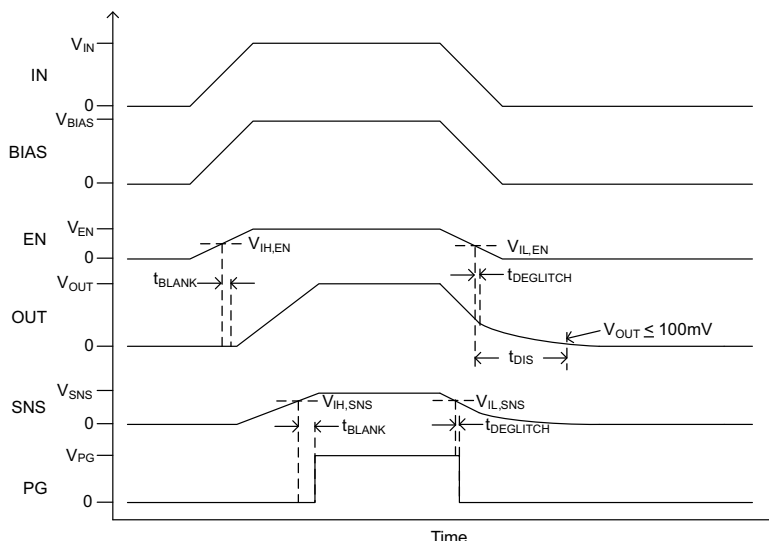

Figure 58. Power Applied and then Removed in a Typical Application

At the end of the t_{DIS} time, it is not guaranteed that V_{OUT} will be 0 V since the final voltage is dependent upon the initial voltage and the C_L capacitor. The final V_{OUT} can be calculated with [Equation 3](#) for a given initial voltage and C_L capacitor.

$$V_f = V_o \times e^{\frac{-t}{RC}}$$

where

- V_f is the final V_{OUT} voltage
- V_o is the initial V_{OUT} voltage
- R is the the value of the output discharge resistor, R_{PD} (see the [Electrical Characteristics](#) table)
- C is the output bulk capacitance on OUT

(3)

Feature Description (continued)

9.3.9 V_{IN} and V_{BIAS} Voltage Range

For optimal R_{ON} performance, make sure $V_{IN} \leq V_{BIAS}$. The device is still functional if $V_{IN} > V_{BIAS}$ but it exhibits R_{ON} greater than what is listed in the [Electrical Characteristics](#) table. See [Figure 59](#) for an example of a typical device. Notice the increasing R_{ON} as V_{IN} increases. Be sure to never exceed the maximum voltage rating for V_{IN} and V_{BIAS} .

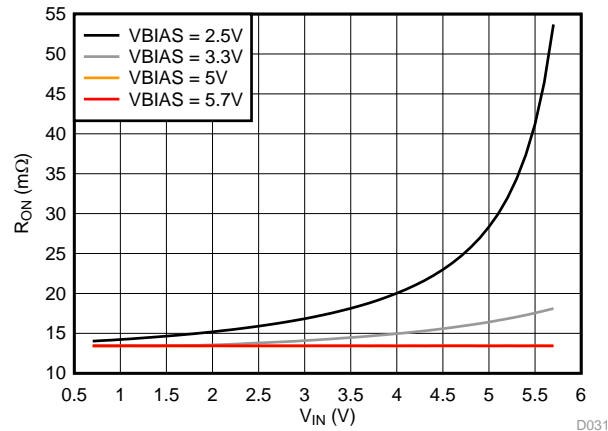

Figure 59. R_{ON} When $V_{IN} > V_{BIAS}$

9.3.10 Adjustable Rise Time (CT pin)

A capacitor to GND on the CT pin sets the slew rate for V_{OUT} . An appropriate capacitance value must be placed on CT such that the I_{MAX} and I_{PLS} specifications of the device are not violated. The capacitor to GND on the CT pin must be rated for 25 V or higher. An approximate formula for the relationship between CT (except for CT = open) and the slew rate for any V_{BIAS} is shown in [Equation 4](#).

$$SR = 0.35 \times CT + 20$$

where

- SR is the slew rate (in $\mu\text{s}/\text{V}$)
 - CT is the the capacitance value on the CT terminal (in pF)
 - The units for the constant 20 are $\mu\text{s}/\text{V}$.
 - The units for the constant 0.35 are $\mu\text{s}/(\text{V} \cdot \text{pF})$.
- (4)

Rise time can be calculated by multiplying the input voltage (typically 10% to 90%) by the slew rate. [Table 1](#) contains rise time values measured on a typical device.

Table 1. Rise Time

CTx (pF)	RISE TIME (μs) 10%–90%, $C_L = 0.1 \mu\text{F}$, $V_{BIAS} = 2.5 \text{ V to } 5.7 \text{ V}$, $R_L = 10 \Omega$ LOAD. TYPICAL VALUES AT 25°C, 25 V X7R 10% CERAMIC CAP					
	5 V	3.3 V	1.8 V	1.5 V	1.2 V	0.7 V
Open	140	98	62	54	46	32
220	444	301	175	150	124	81
470	767	518	299	255	210	133
1000	1492	994	562	474	387	245
2200	3105	2050	1151	961	787	490
4700	6420	4246	2365	1980	1612	998
10000	14059	9339	5183	4331	3533	2197

9.3.11 Power Sequencing

The TPS2295x operates regardless of power-on and power-off sequencing order. The order in which voltages are applied to IN, BIAS, and EN will not damage the device as long as the voltages do not exceed the absolute maximum operating conditions. If voltage is applied to EN before IN and BIAS, the slew rate of VOUT will not be controlled. Also, turning off IN and/or BIAS while EN is high will not damage the device.

9.4 Device Functional Modes

[Table 2](#) describes what the OUT pin is connected to for a particular device as determined by the EN pin.

Table 2. Function Table

EN	TPS22953	TPS22954
L	OPEN	R _{PD} to GND
H	IN	IN

10 Application and Implementation

NOTE

Information in the following applications sections is not part of the TI component specification, and TI does not warrant its accuracy or completeness. TI's customers are responsible for determining suitability of components for their purposes. Customers should validate and test their design implementation to confirm system functionality.

10.1 Application Information

This section will highlight some of the design considerations when implementing this device in various applications. A PSPICE model for this device is also available on www.ti.com for further aid.

10.1.1 Input to Output Voltage Drop

The input to output voltage drop in the device is determined by the R_{ON} of the device and the load current. The R_{ON} of the device depends upon the V_{IN} and V_{BIAS} conditions of the device. Refer to the R_{ON} specification of the device in the [Electrical Characteristics](#) table of this datasheet. Once the R_{ON} of the device is determined based upon the V_{IN} and V_{BIAS} voltage conditions, use [Equation 5](#) to calculate the input to output voltage drop.

$$\Delta V = I_{LOAD} \times R_{ON}$$

where

- ΔV is the voltage drop from IN to OUT
- I_{LOAD} is the load current
- R_{ON} is the On-Resistance of the device for a specific V_{IN} and V_{BIAS} (5)

An appropriate I_{LOAD} must be chosen such that the I_{MAX} specification of the device is not violated.

10.1.2 Thermal Considerations

The maximum IC junction temperature must be restricted to just under the thermal shutdown (T_{SD}) limit of the device. To calculate the maximum allowable dissipation, $P_{D(max)}$ for a given output current and ambient temperature, use [Equation 6](#).

$$P_{D(max)} = \frac{T_{J(max)} - T_A}{\theta_{JA}}$$

where

- $P_{D(max)}$ is the maximum allowable power dissipation
- $T_{J(max)}$ is the maximum allowable junction temperature before hitting thermal shutdown (see the [Electrical Characteristics](#) table)
- T_A is the ambient temperature of the device
- θ_{JA} is the junction to air thermal impedance. See the [Thermal Information](#) section. This parameter is highly dependent upon board layout. (6)

Application Information (continued)

10.1.3 Automatic Power Sequencing

The PG pin of the TPS22953/54 allows for automatic sequencing of multiple system rails or loads. The accurate SNS voltage monitoring ensures the first rail is up before the next starts to turn on. This approach provides robust system sequencing and reduces the total inrush current by preventing overlap. Figure 60 shows how two rails can be sequenced. There is no limit to the number of rails that can be sequenced in this way

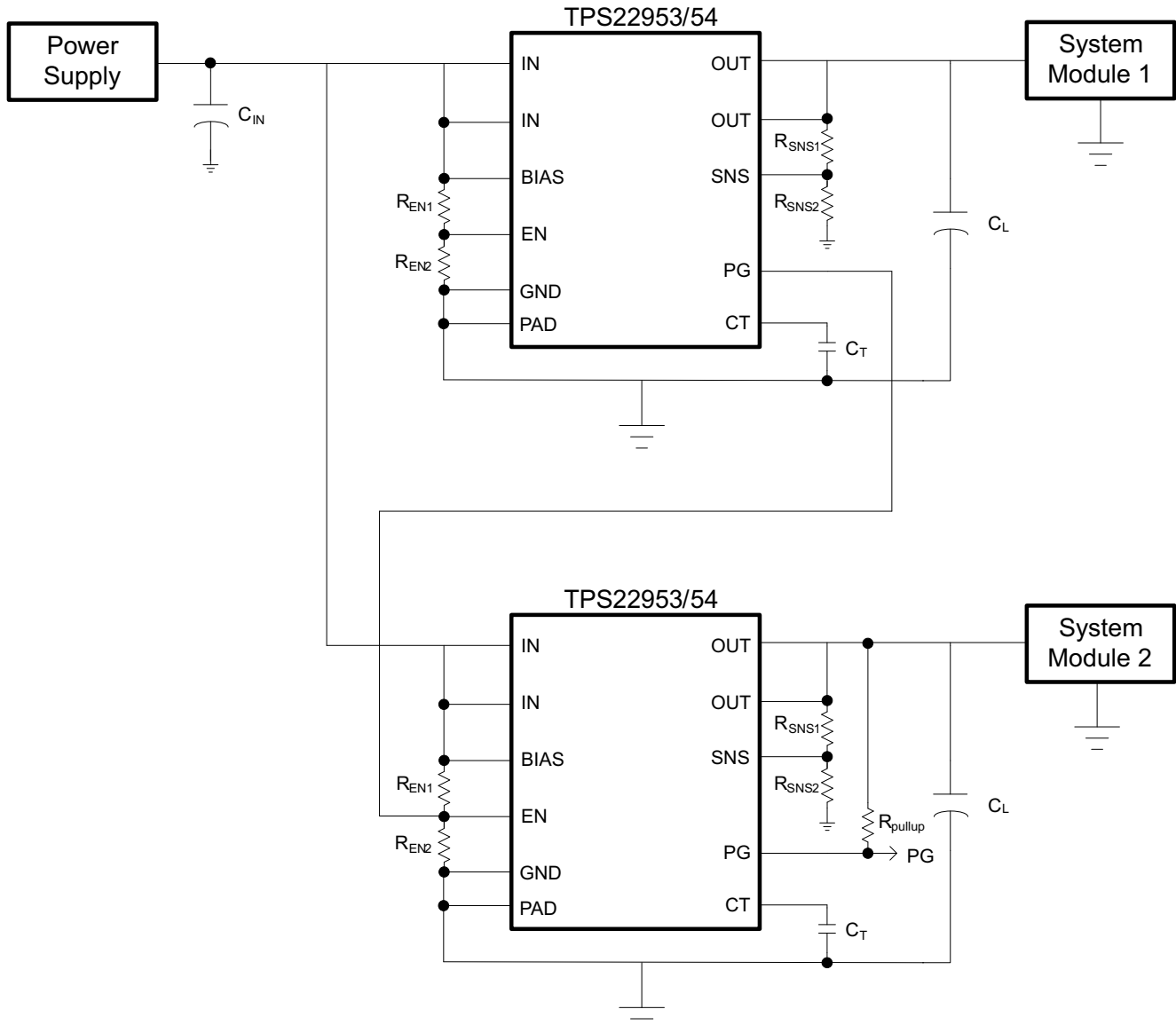

Figure 60. Power Sequencing with PG Control Schematic

Application Information (continued)

10.1.4 Monitoring a Downstream Voltage

The SNS pin can be used to monitor other system voltages in addition to V_{OUT} . The status of the monitored voltage are indicated by the PG pin which can be pulled up to V_{OUT} or another voltage. Figure 61 shows an example of the TPS22953/54 monitoring the output of a downstream DC/DC regulator. In this case, the switch turns on when the power supply is above the UVLO, but the PG is not asserted until the DC/DC regulator has started up.

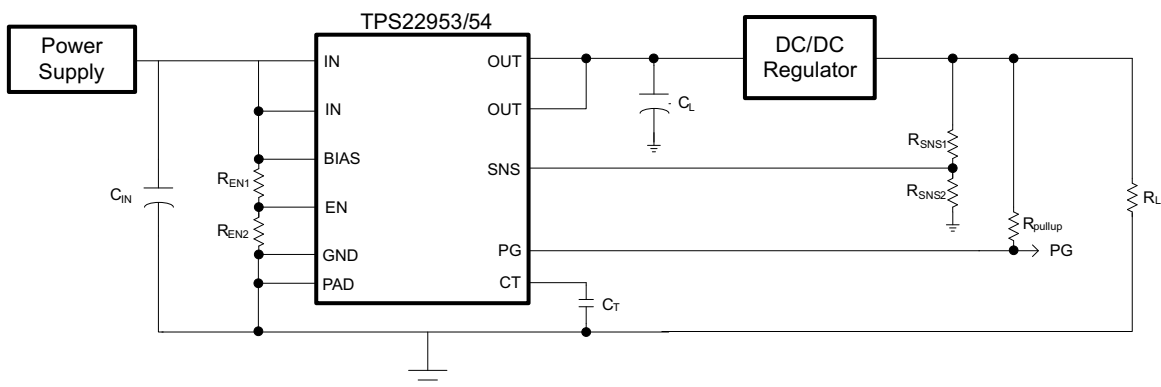

Figure 61. Monitoring a Downstream Voltage Schematic

In this application, if the DC/DC Regulator is shut down, the supervisor registers this as a fault case and reset the load switch.

10.1.5 Monitoring the Input Voltage

The SNS pin can also be used to monitor V_{IN} in the case a MCU GPIO is being used to control the EN. This allows PG to report on the status of the input voltage when the switch is enabled. See Figure 62.

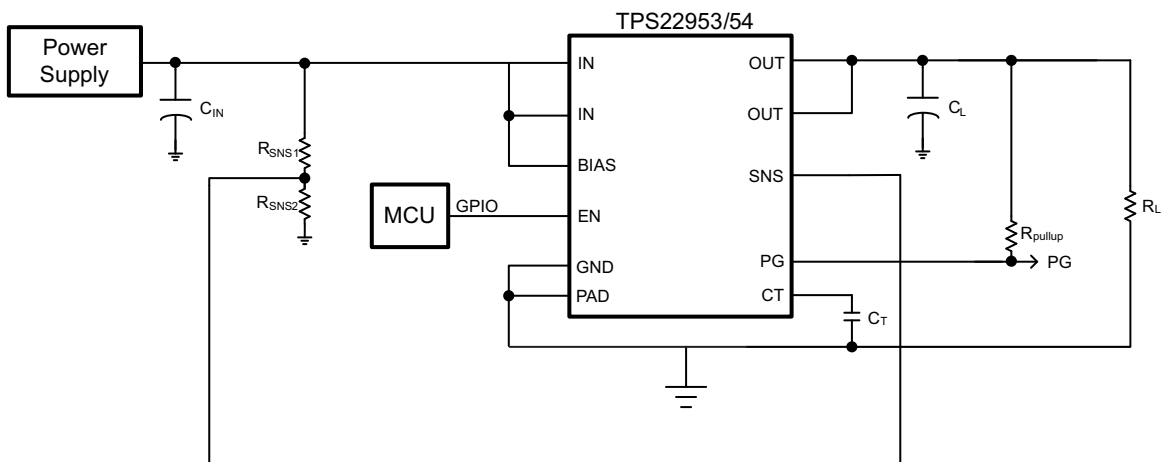

Figure 62. Monitoring The Input Voltage Schematic

Application Information (continued)
10.1.6 Break-Before-Make Power MUX (TPS22953 Only)

The reverse current blocking feature of the TPS22953 makes it suitable for power multiplexing (MUXing) between two power supplies with different voltages. The SNS and PG pin can be configured to implement break-before-make logic. The circuit in [Figure 63](#) shows how the detection of Power Supply 1 can be used to disable the load switch for Power Supply 2. By tying the SNS of Load Switch 1 directly to the input, its PG pin is pulled up as soon as the device is enabled.

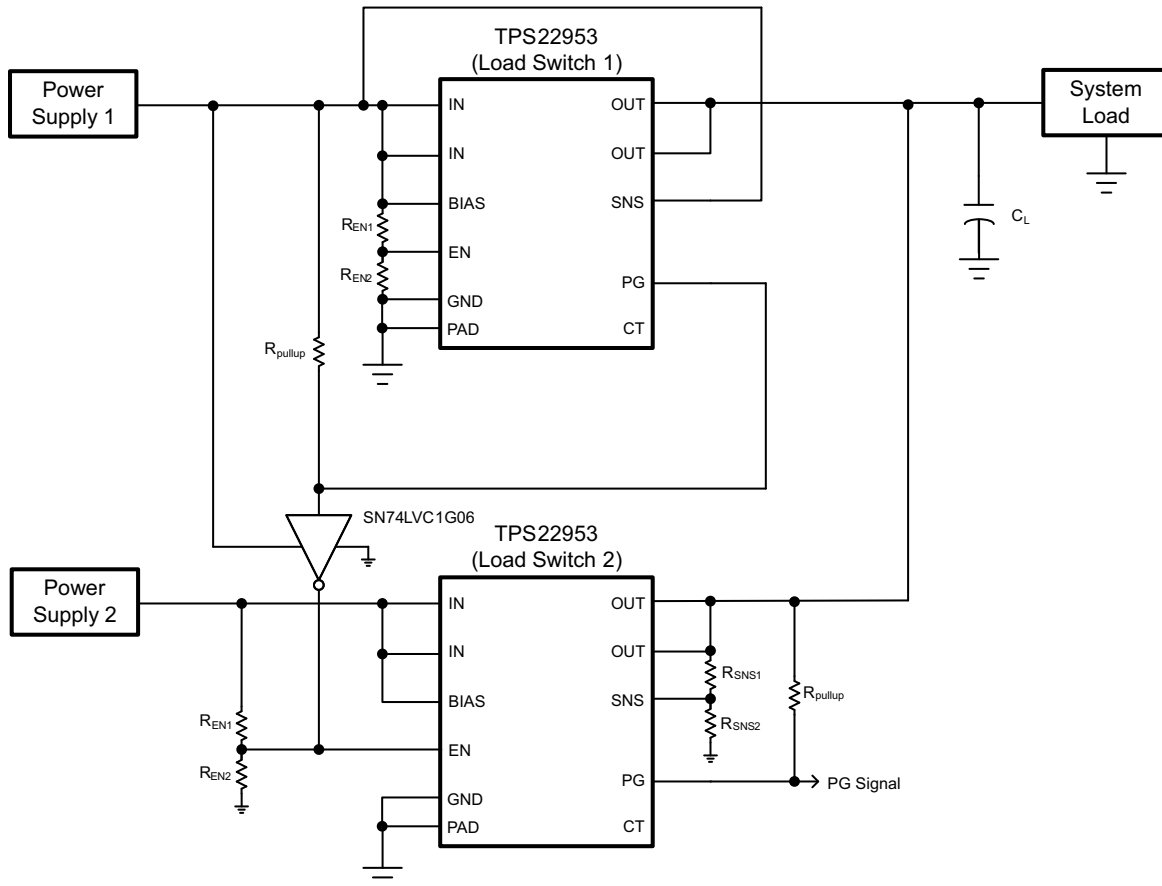

Figure 63. Break-Before-Make Power MUX Schematic

The break-before-make logic ensures that Power Supply 2 is completely disconnected before Power Supply 1 is connected. This approach provides very robust reverse current blocking. However, in most cases, this also results in a dip in the output voltage when switching between supplies.

The amount of voltage dip depends on the loading, the output capacitance, and the turnon delay of the load switch. In this application, leaving the CT pin open results in the shortest turn on delay and minimize the output voltage dip.

[Table 3](#) summarizes the logic of the PG Signal for [Figure 63](#).

Table 3. Break-Before-Make PG Signal

PG Signal	Indication
H	Power supply 1 not present. System powered from power supply 2.
L	Power supply 1 present. System powered from power supply 1.

10.1.7 Make-Before-Break Power MUX (TPS22953 Only)

The reverse current blocking feature of the TPS22953 makes it suitable for power multiplexing (MUXing) between two power supplies with different voltages. The SNS and PG pin can be configured to implement make-before-break logic. The circuit in Figure 64 shows how the detection of Load Switch 1 turning on can be used to disable the load switch for Power Supply 2. By tying SNS to the Load, the PG is pulled up when the output voltage starts to rise. This disables an active low load switch such as the TPS22910A.

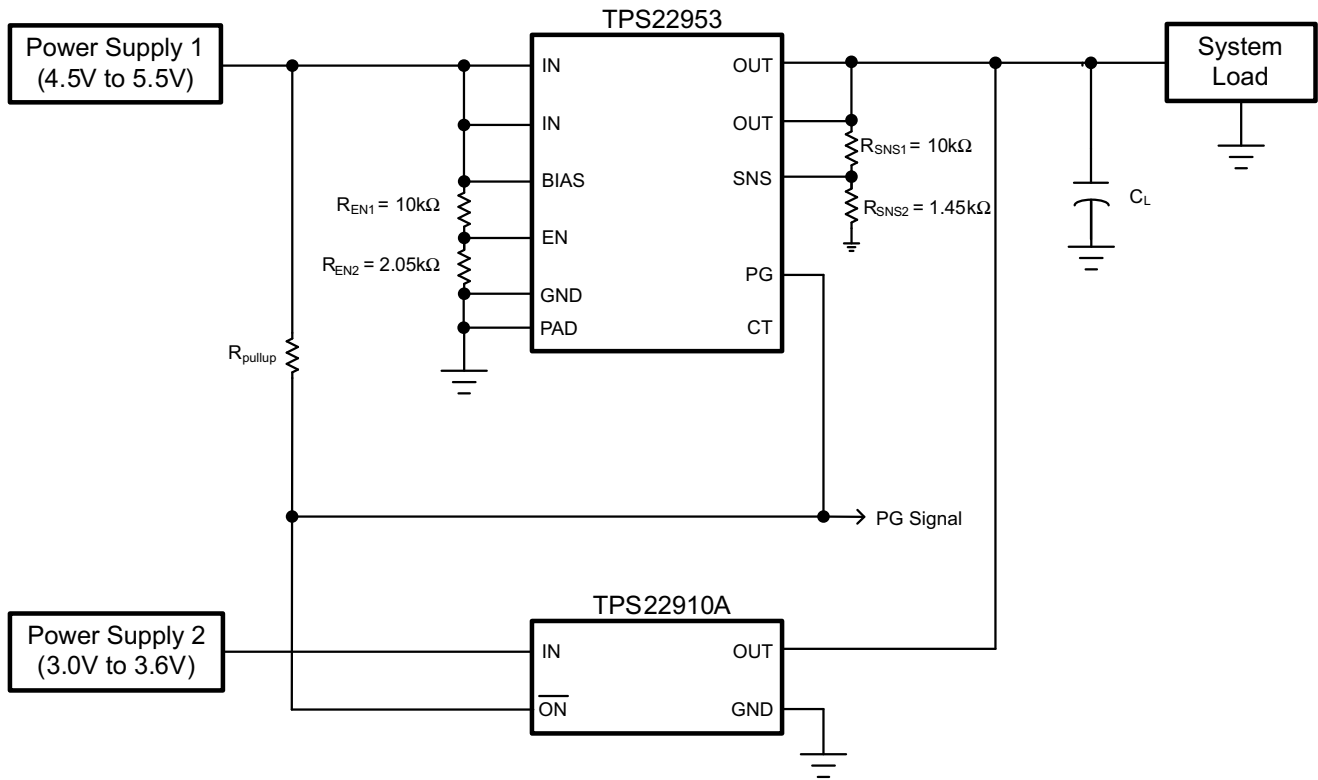

Figure 64. Make-Before-Break Power MUX Schematic

The make-before-break logic ensures that Power Supply 2 is not disconnected until Power Supply 1 is connected. Unlike break-before-make logic, this approach is ideal for preventing voltage dip on the output when switching between supplies. However, in most cases, this also results in temporary reverse current flow.

The TPS22910A is well suited for this application because it can detect and block reverse current even before it is disabled by the TPS22953 PG signal. Also, the active low enable of the TPS22910A eliminates the need for an inverter as shown in the previous example.

In order to ensure correct logic, the SNS pin must be configured to toggle PG when the load voltage is between the two supply voltages (3.6 V to 4.5 V). The SNS resistor values in Figure 64 are assuming a tolerance of $\pm 1\%$ or better.

Table 4 summarizes the logic of the PG Signal for Figure 64.

Table 4. Make-Before-Break PG Signal

PG Signal	Indication
H	Power supply 1 present. System powered from power supply 1.
L	Power supply 1 not present. System powered from power supply 2.

10.2 Typical Application

This application demonstrates how the TPS22953/54 can be used to limit inrush current to output capacitance.

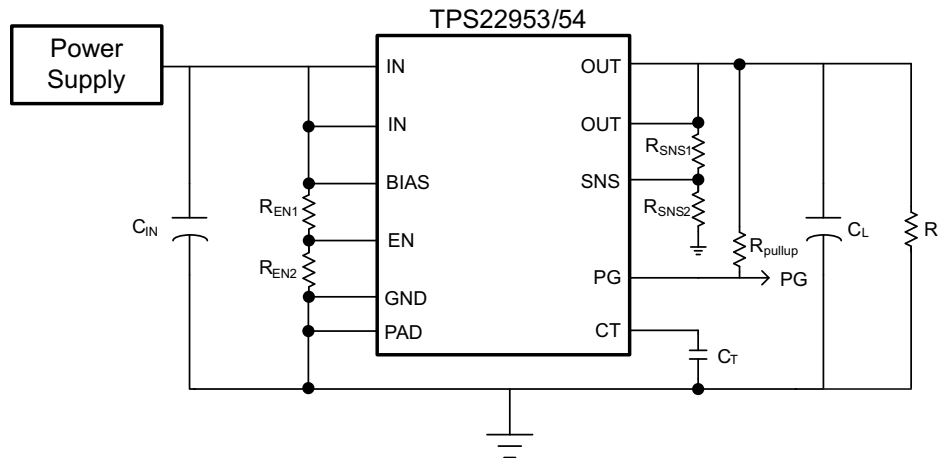

Figure 65. Powering a Downstream Module Schematic

10.2.1 Design Requirements

For this design example, use the input parameters shown in [Table 5](#).

Table 5. Design Parameters

DESIGN PARAMETER	EXAMPLE VALUE
V_{IN}	3.3 V
V_{BIAS}	5 V
C_L	47 μ F
Maximum Acceptable Inrush Current	150 mA
R_L	None

10.2.2 Detailed Design Procedure

To begin the design process, the designer needs to know the following:

- Input voltage
- BIAS voltage
- Load current
- Load capacitance
- Maximum acceptable inrush current

10.2.2.1 Inrush Current

To determine how much inrush current is caused by the C_L capacitor, use [Equation 7](#).

$$I_{INRUSH} = C_L \times \frac{dV_{OUT}}{dt}$$

where

- I_{INRUSH} is the amount of inrush caused by C_L
 - C_L is the load capacitance on V_{OUT}
 - dt is the V_{OUT} Rise Time (typically 10% to 90%)
 - dV_{OUT} is the Change in V_{OUT} Voltage (typically 10% to 90%)
- (7)

In this case, a Slew Rate slower than 314 μ s/V is required to meet the maximum acceptable inrush requirement. [Equation 4](#) can be used to estimate the C_T capacitance (as shown in [Equation 8](#) and [Equation 9](#)) required for this slew rate.

$$314 \mu\text{s/V} = 0.35 \times \text{CT} + 20 \tag{8}$$

$$\text{CT} = 840 \text{ pF} \tag{9}$$

10.2.3 Application Curves

The following Application Curves show the inrush with multiple different CT values. These curves show only a CT capacitance greater than 840 pF results in the acceptable inrush current of 150 mA.

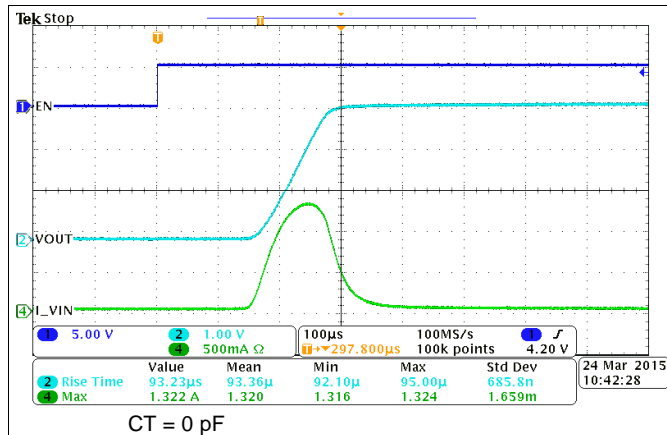

Figure 66. Inrush with CT = 0 pF

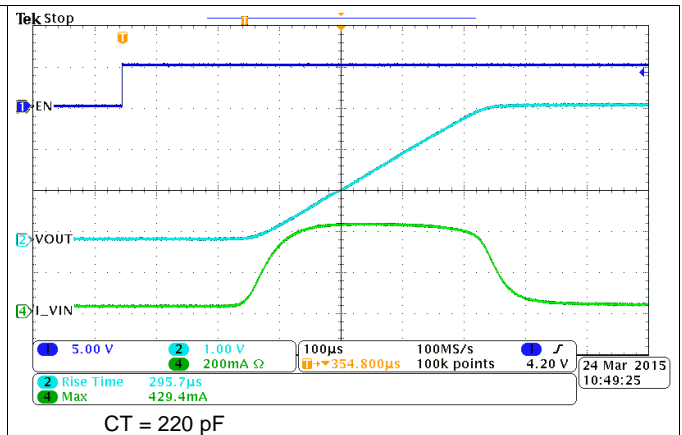

Figure 67. Inrush with CT = 220 pF

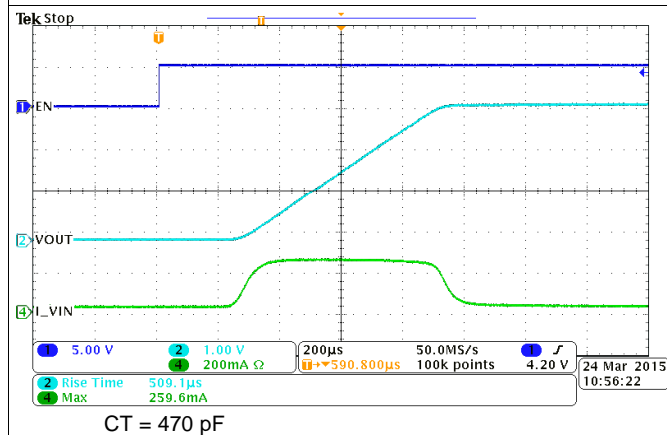

Figure 68. Inrush with CT = 470 pF

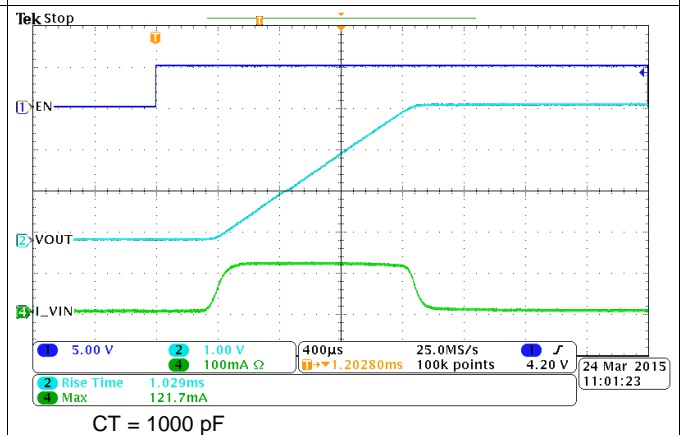

Figure 69. Inrush with CT = 1000 pF

TPS22954, TPS22953

SLVSCT5D – MARCH 2015 – REVISED SEPTEMBER 2016

www.ti.com

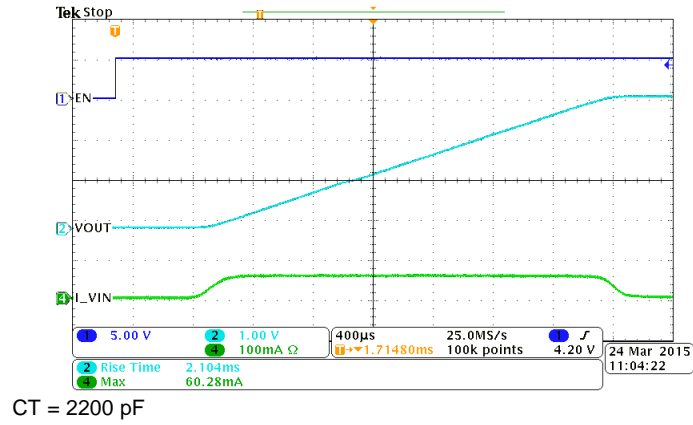

Figure 70. Inrush with CT = 2200 pF

11 Power Supply Recommendations

The device is designed to operate from a V_{BIAS} range of 2.5 V to 5.7 V and a V_{IN} range of 0.7 V to 5.7 V. The power supply must be well regulated and placed as close to the device terminals as possible. It must be able to withstand all transient and load current steps. In most situations, using an input capacitance of 1 μF is sufficient to prevent the supply voltage from dipping when the switch is turned on. In cases where the power supply is slow to respond to a large transient current or large load current step, additional bulk capacitance may be required on the input.

The requirements for larger input capacitance can be mitigated by adding additional capacitance to the CT pin. This causes the load switch to turn on more slowly. Not only does this reduce transient inrush current, but it also gives the power supply more time to respond to the load current step.

12 Layout

12.1 Layout Guidelines

- Input and Output traces must be as short and wide as possible to accommodate for high current.
- Use vias under the exposed thermal pad for thermal relief for high current operation.
- The CT Capacitor must be placed as close as possible to the device to minimize parasitic trace capacitance. It is also recommended to cutout copper on other layers directly below CT to minimize parasitic capacitance.
- The IN terminal must be bypassed to ground with low ESR ceramic bypass capacitors. The typical recommended bypass capacitance is ceramic with X5R or X7R dielectric. This capacitor must be placed as close to the device pins as possible.
- The OUT terminal must be bypassed to ground with low ESR ceramic bypass capacitors. The typical recommended bypass capacitance is ceramic with X5R or X7R dielectric. This capacitor must be placed as close to the device pins as possible.
- The BIAS terminal must be bypassed to ground with low ESR ceramic bypass capacitors. The typical recommended bypass capacitance is ceramic with X5R or X7R dielectric.

12.2 Layout Example

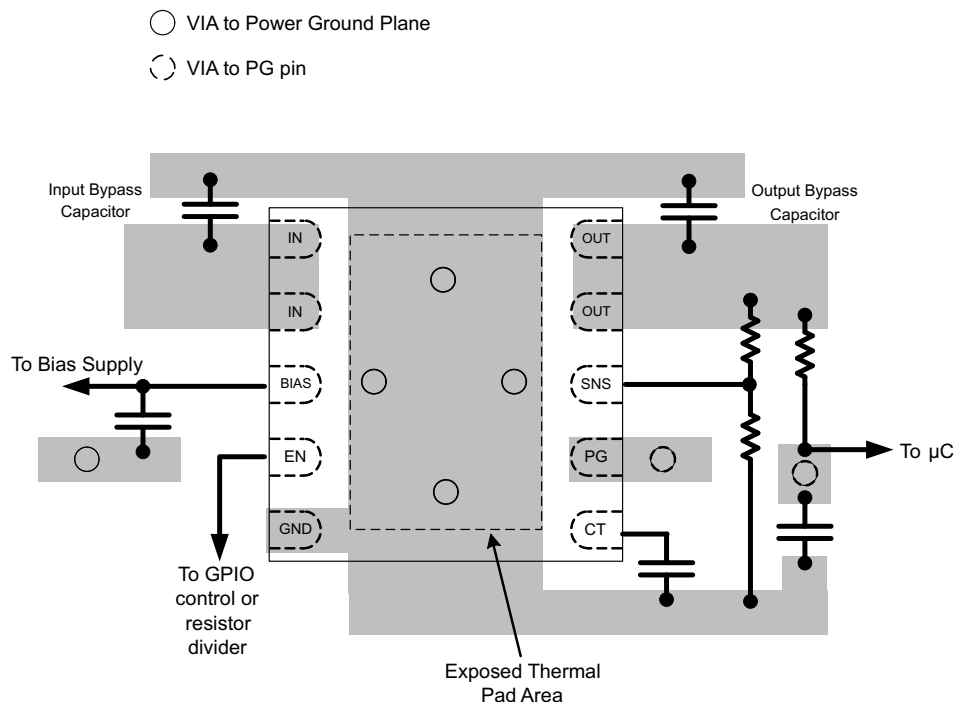

Figure 71. Recommended Board Layout

13 Device and Documentation Support

13.1 Documentation Support

13.1.1 Related Documentation

For related documentation see the following:

- [TPS22953/54 User's Guide](#)
- [Basics of Load Switches](#)
- [Managing Inrush Current](#)
- [Reverse Current Protection in Load Switches](#)
- [Quiescent Current vs Shutdown Current for Load Switch Power Consumption](#)
- [Load Switch Thermal Considerations](#)

13.2 Related Links

The table below lists quick access links. Categories include technical documents, support and community resources, tools and software, and quick access to sample or buy.

Table 6. Related Links

PARTS	PRODUCT FOLDER	SAMPLE & BUY	TECHNICAL DOCUMENTS	TOOLS & SOFTWARE	SUPPORT & COMMUNITY
TPS22953	Click here	Click here	Click here	Click here	Click here
TPS22954	Click here	Click here	Click here	Click here	Click here

13.3 Receiving Notification of Documentation Updates

To receive notification of documentation updates, navigate to the device product folder on ti.com. In the upper right corner, click on *Alert me* to register and receive a weekly digest of any product information that has changed. For change details, review the revision history included in any revised document.

13.4 Community Resources

The following links connect to TI community resources. Linked contents are provided "AS IS" by the respective contributors. They do not constitute TI specifications and do not necessarily reflect TI's views; see TI's [Terms of Use](#).

TI E2E™ Online Community *TI's Engineer-to-Engineer (E2E) Community*. Created to foster collaboration among engineers. At e2e.ti.com, you can ask questions, share knowledge, explore ideas and help solve problems with fellow engineers.

Design Support *TI's Design Support* Quickly find helpful E2E forums along with design support tools and contact information for technical support.

13.5 Trademarks

E2E is a trademark of Texas Instruments.

All other trademarks are the property of their respective owners.

13.6 Electrostatic Discharge Caution



This integrated circuit can be damaged by ESD. Texas Instruments recommends that all integrated circuits be handled with appropriate precautions. Failure to observe proper handling and installation procedures can cause damage.

ESD damage can range from subtle performance degradation to complete device failure. Precision integrated circuits may be more susceptible to damage because very small parametric changes could cause the device not to meet its published specifications.

13.7 Glossary

SLYZ022 — *TI Glossary*.

This glossary lists and explains terms, acronyms, and definitions.

14 Mechanical, Packaging, and Orderable Information

The following pages include mechanical, packaging, and orderable information. This information is the most current data available for the designated devices. This data is subject to change without notice and revision of this document. For browser-based versions of this data sheet, refer to the left-hand navigation.

PACKAGING INFORMATION

Orderable Device	Status (1)	Package Type	Package Drawing	Pins	Package Qty	Eco Plan (2)	Lead finish/ Ball material (6)	MSL Peak Temp (3)	Op Temp (°C)	Device Marking (4/5)	Samples
TPS22953DQCR	ACTIVE	WSON	DQC	10	3000	RoHS & Green	Call TI NIPDAU	Level-2-260C-1 YEAR	-40 to 105	RB953	Samples
TPS22953DSQR	ACTIVE	WSON	DSQ	10	3000	RoHS & Green	Call TI NIPDAUAG NIPDAU	Level-2-260C-1 YEAR	-40 to 105	ZFDI	Samples
TPS22954DQCR	ACTIVE	WSON	DQC	10	3000	RoHS & Green	Call TI NIPDAU	Level-2-260C-1 YEAR	-40 to 105	RB954	Samples
TPS22954DSQR	ACTIVE	WSON	DSQ	10	3000	RoHS & Green	Call TI NIPDAUAG NIPDAU	Level-2-260C-1 YEAR	-40 to 105	ZDKI	Samples

(1) The marketing status values are defined as follows:

ACTIVE: Product device recommended for new designs.

LIFEBUY: TI has announced that the device will be discontinued, and a lifetime-buy period is in effect.

NRND: Not recommended for new designs. Device is in production to support existing customers, but TI does not recommend using this part in a new design.

PREVIEW: Device has been announced but is not in production. Samples may or may not be available.

OBSELETE: TI has discontinued the production of the device.

(2) **RoHS:** TI defines "RoHS" to mean semiconductor products that are compliant with the current EU RoHS requirements for all 10 RoHS substances, including the requirement that RoHS substance do not exceed 0.1% by weight in homogeneous materials. Where designed to be soldered at high temperatures, "RoHS" products are suitable for use in specified lead-free processes. TI may reference these types of products as "Pb-Free".

RoHS Exempt: TI defines "RoHS Exempt" to mean products that contain lead but are compliant with EU RoHS pursuant to a specific EU RoHS exemption.

Green: TI defines "Green" to mean the content of Chlorine (Cl) and Bromine (Br) based flame retardants meet JS709B low halogen requirements of <=1000ppm threshold. Antimony trioxide based flame retardants must also meet the <=1000ppm threshold requirement.

(3) MSL, Peak Temp. - The Moisture Sensitivity Level rating according to the JEDEC industry standard classifications, and peak solder temperature.

(4) There may be additional marking, which relates to the logo, the lot trace code information, or the environmental category on the device.

(5) Multiple Device Markings will be inside parentheses. Only one Device Marking contained in parentheses and separated by a "~" will appear on a device. If a line is indented then it is a continuation of the previous line and the two combined represent the entire Device Marking for that device.

(6) Lead finish/Ball material - Orderable Devices may have multiple material finish options. Finish options are separated by a vertical ruled line. Lead finish/Ball material values may wrap to two lines if the finish value exceeds the maximum column width.

Important Information and Disclaimer:The information provided on this page represents TI's knowledge and belief as of the date that it is provided. TI bases its knowledge and belief on information provided by third parties, and makes no representation or warranty as to the accuracy of such information. Efforts are underway to better integrate information from third parties. TI has taken and

continues to take reasonable steps to provide representative and accurate information but may not have conducted destructive testing or chemical analysis on incoming materials and chemicals. TI and TI suppliers consider certain information to be proprietary, and thus CAS numbers and other limited information may not be available for release.

In no event shall TI's liability arising out of such information exceed the total purchase price of the TI part(s) at issue in this document sold by TI to Customer on an annual basis.

OTHER QUALIFIED VERSIONS OF TPS22953, TPS22954 :

- Automotive : [TPS22953-Q1](#), [TPS22954-Q1](#)

NOTE: Qualified Version Definitions:

- Automotive - Q100 devices qualified for high-reliability automotive applications targeting zero defects

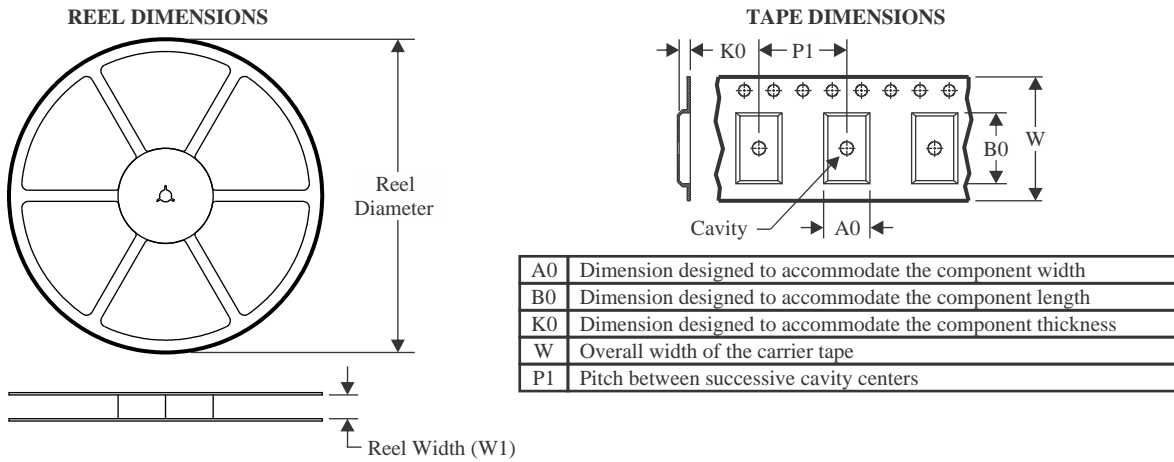
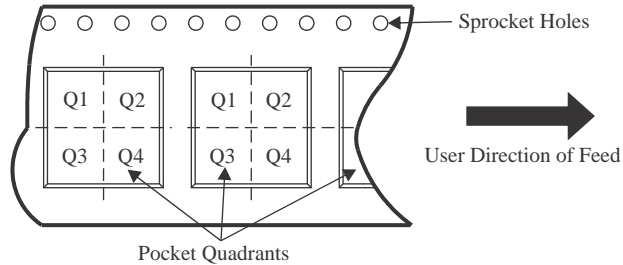
TAPE AND REEL INFORMATION

QUADRANT ASSIGNMENTS FOR PIN 1 ORIENTATION IN TAPE

*All dimensions are nominal

Device	Package Type	Package Drawing	Pins	SPQ	Reel Diameter (mm)	Reel Width W1 (mm)	A0 (mm)	B0 (mm)	K0 (mm)	P1 (mm)	W (mm)	Pin1 Quadrant
TPS22953DQCR	WSO	DQC	10	3000	180.0	8.4	2.25	3.25	1.05	4.0	8.0	Q1
TPS22953DSQR	WSO	DSQ	10	3000	180.0	8.4	2.3	2.3	1.15	4.0	8.0	Q2
TPS22954DQCR	WSO	DQC	10	3000	180.0	8.4	2.25	3.25	1.05	4.0	8.0	Q1
TPS22954DSQR	WSO	DSQ	10	3000	180.0	8.4	2.3	2.3	1.15	4.0	8.0	Q2

TAPE AND REEL BOX DIMENSIONS

*All dimensions are nominal

Device	Package Type	Package Drawing	Pins	SPQ	Length (mm)	Width (mm)	Height (mm)
TPS22953DQCR	WSON	DQC	10	3000	210.0	185.0	35.0
TPS22953DSQR	WSON	DSQ	10	3000	210.0	185.0	35.0
TPS22954DQCR	WSON	DQC	10	3000	210.0	185.0	35.0
TPS22954DSQR	WSON	DSQ	10	3000	182.0	182.0	20.0

GENERIC PACKAGE VIEW

DQC 10

WSON - 0.8 mm max height

PLASTIC SMALL OUTLINE - NO LEAD

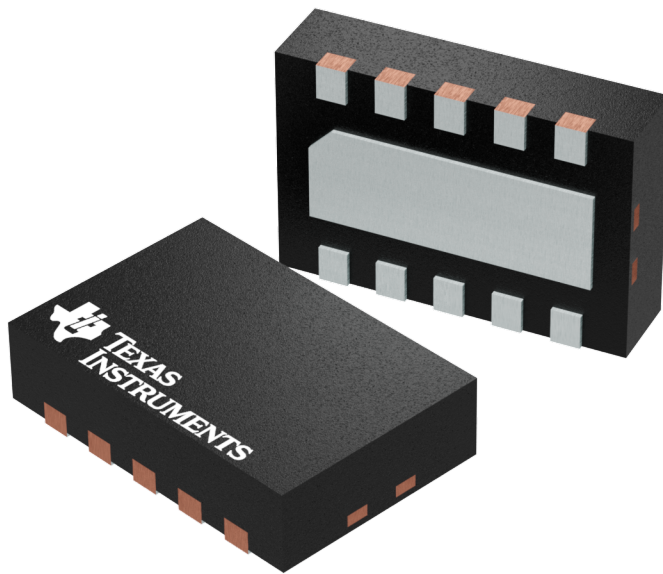

Images above are just a representation of the package family, actual package may vary.
Refer to the product data sheet for package details.

4209674/B

EXAMPLE BOARD LAYOUT

DQC0010A

WSO - 0.8mm max height

PLASTIC SMALL OUTLINE - NO LEAD

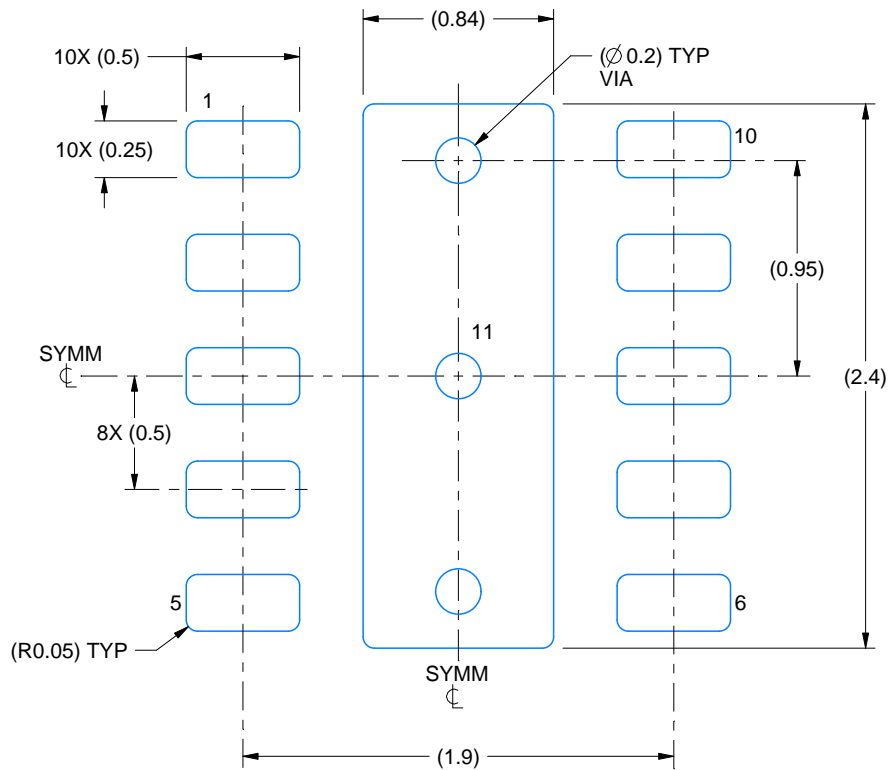

LAND PATTERN EXAMPLE
SCALE: 30X

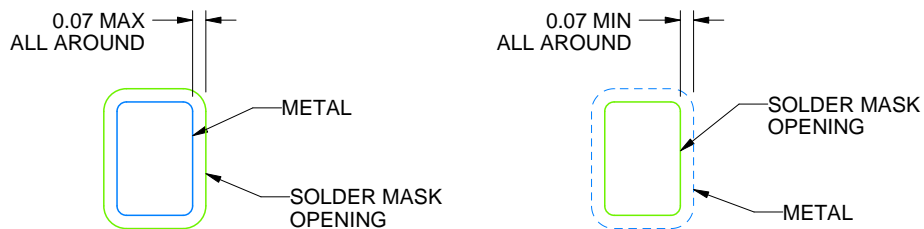

NON SOLDER MASK
DEFINED
(PREFERRED)

SOLDER MASK
DEFINED

SOLDER MASK DETAILS

4218281/C 11/2022

NOTES: (continued)

4. This package is designed to be soldered to a thermal pad on the board. For more information, see Texas Instruments literature number SLUA271 (www.ti.com/lit/sluea271).
5. Vias are optional depending on application, refer to device data sheet. If any vias are implemented, refer to their locations shown on this view. It is recommended that vias under paste be filled, plugged or tented.

EXAMPLE STENCIL DESIGN

DQC0010A

WSN - 0.8mm max height

PLASTIC SMALL OUTLINE - NO LEAD

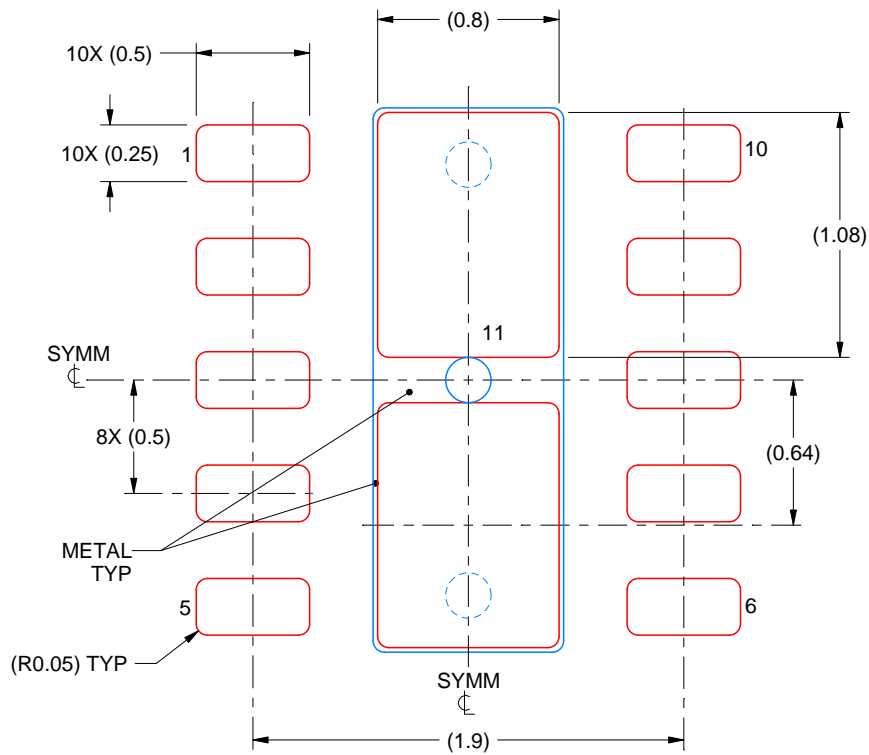

SOLDER PASTE EXAMPLE
BASED ON 0.125 mm THICK STENCIL

EXPOSED PAD 11:
86% PRINTED SOLDER COVERAGE BY AREA UNDER PACKAGE
SCALE: 30X

4218281/C 11/2022

NOTES: (continued)

6. Laser cutting apertures with trapezoidal walls and rounded corners may offer better paste release. IPC-7525 may have alternate design recommendations.

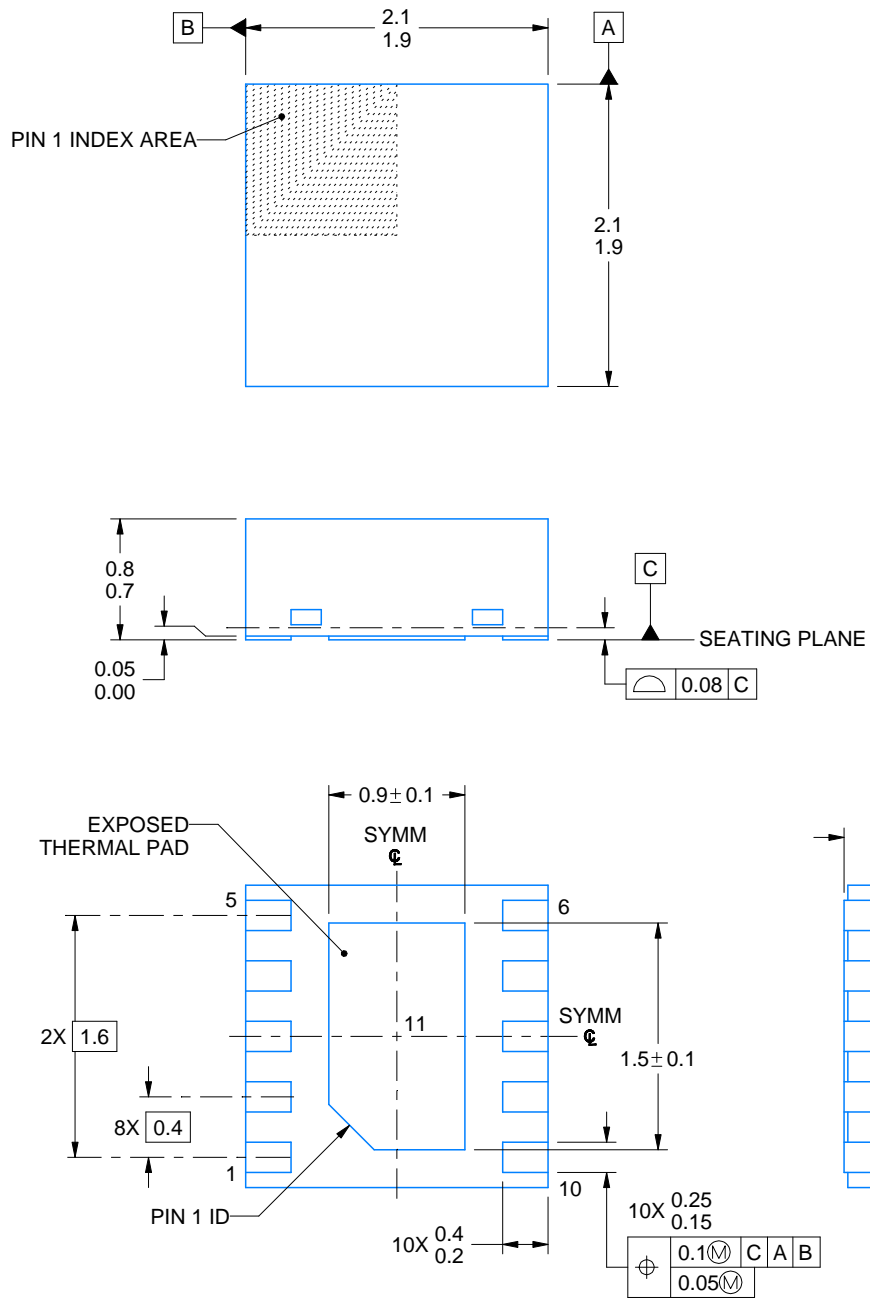
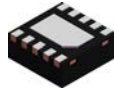

4218906/A 04/2019

NOTES:

1. All linear dimensions are in millimeters. Any dimensions in parenthesis are for reference only. Dimensioning and tolerancing per ASME Y14.5M.
2. This drawing is subject to change without notice.
3. The package thermal pad must be soldered to the printed circuit board for thermal and mechanical performance.

EXAMPLE BOARD LAYOUT

DSQ0010A

WSON - 0.8 mm max height

PLASTIC SMALL OUTLINE - NO LEAD

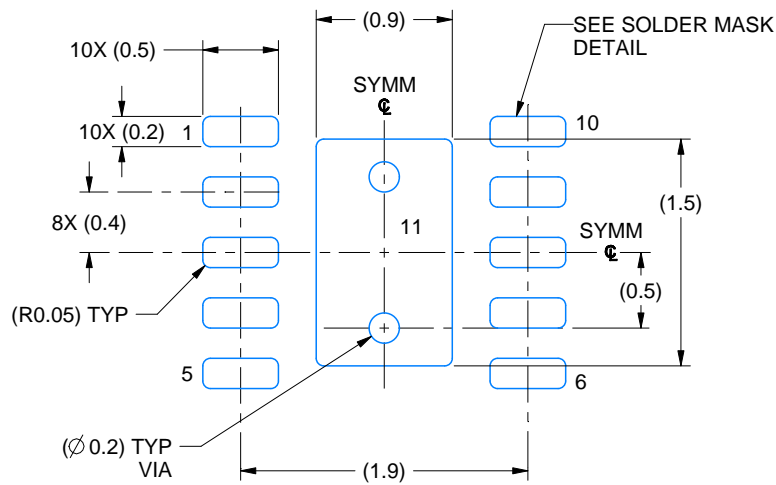

LAND PATTERN EXAMPLE
EXPOSED METAL SHOWN
SCALE: 20X

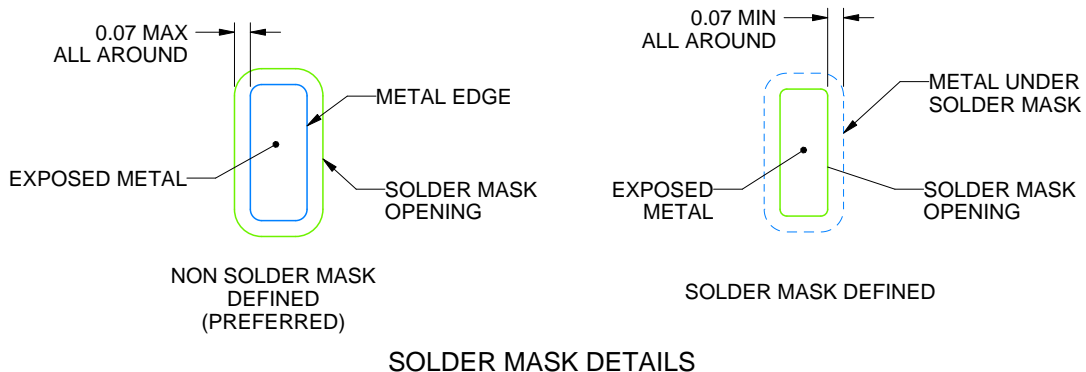

SOLDER MASK DETAILS

4218906/A 04/2019

NOTES: (continued)

4. This package is designed to be soldered to a thermal pad on the board. For more information, see Texas Instruments literature number SLUA271 (www.ti.com/lit/slua271).
5. Vias are optional depending on application, refer to device data sheet. If any vias are implemented, refer to their locations shown on this view. It is recommended that vias under paste be filled, plugged or tented.

EXAMPLE STENCIL DESIGN

DSQ0010A

WSON - 0.8 mm max height

PLASTIC SMALL OUTLINE - NO LEAD

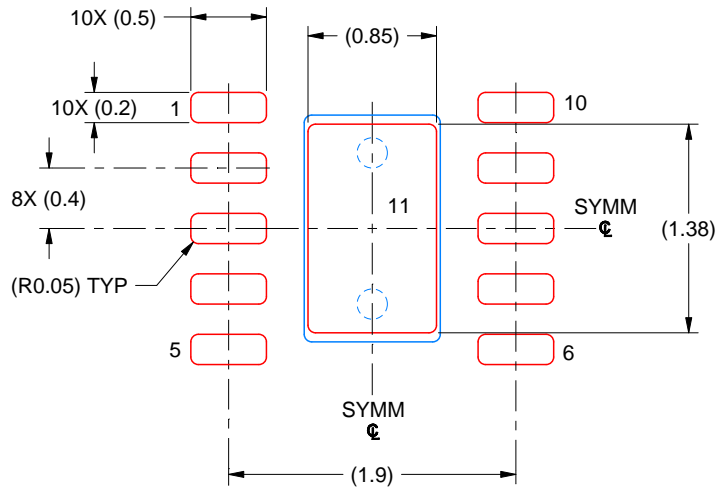

SOLDER PASTE EXAMPLE
BASED ON 0.125 MM THICK STENCIL
SCALE: 20X

EXPOSED PAD 11
87% PRINTED SOLDER COVERAGE BY AREA UNDER PACKAGE

4218906/A 04/2019

NOTES: (continued)

6. Laser cutting apertures with trapezoidal walls and rounded corners may offer better paste release. IPC-7525 may have alternate design recommendations.

IMPORTANT NOTICE AND DISCLAIMER

TI PROVIDES TECHNICAL AND RELIABILITY DATA (INCLUDING DATA SHEETS), DESIGN RESOURCES (INCLUDING REFERENCE DESIGNS), APPLICATION OR OTHER DESIGN ADVICE, WEB TOOLS, SAFETY INFORMATION, AND OTHER RESOURCES "AS IS" AND WITH ALL FAULTS, AND DISCLAIMS ALL WARRANTIES, EXPRESS AND IMPLIED, INCLUDING WITHOUT LIMITATION ANY IMPLIED WARRANTIES OF MERCHANTABILITY, FITNESS FOR A PARTICULAR PURPOSE OR NON-INFRINGEMENT OF THIRD PARTY INTELLECTUAL PROPERTY RIGHTS.

These resources are intended for skilled developers designing with TI products. You are solely responsible for (1) selecting the appropriate TI products for your application, (2) designing, validating and testing your application, and (3) ensuring your application meets applicable standards, and any other safety, security, regulatory or other requirements.

These resources are subject to change without notice. TI grants you permission to use these resources only for development of an application that uses the TI products described in the resource. Other reproduction and display of these resources is prohibited. No license is granted to any other TI intellectual property right or to any third party intellectual property right. TI disclaims responsibility for, and you will fully indemnify TI and its representatives against, any claims, damages, costs, losses, and liabilities arising out of your use of these resources.

TI's products are provided subject to [TI's Terms of Sale](#) or other applicable terms available either on [ti.com](https://www.ti.com) or provided in conjunction with such TI products. TI's provision of these resources does not expand or otherwise alter TI's applicable warranties or warranty disclaimers for TI products.

TI objects to and rejects any additional or different terms you may have proposed.

Mailing Address: Texas Instruments, Post Office Box 655303, Dallas, Texas 75265
Copyright © 2024, Texas Instruments Incorporated

Looking for pricing, stock, or lifecycle information?

Click below to explore more details on WIN SOURCE:

- ⊖ [View M2GL050-VFG400I on WIN SOURCE](#)
- ⊖ [Microchip Technology](#) Information

Optimize Your Supply Chain with WIN SOURCE Solutions

- ✓ Global Sourcing Solution
- ✓ Obsolete Management
- ✓ Cost Control Management
- ✓ Shortage Management
- ✓ Alternative Solution
- ✓ Excess Inventory Management