



**THE DATASHEET OF
RS3-1209S/H3**



Features

Regulated Converters

- 2:1 and 3:1 wide input voltage ranges
- 1kVDC, 2kVDC and 3kVDC isolation
- UL94V-0 package material
- Continuous short circuit protection
- Low ripple and noise
- CTRL On/Off
- Efficiency up to 83%

RS3-S(D)(Z)

3 Watt
SIP8
Single and Dual
Output



UL60950-1 certified
CAN/CSA C22.2 No. 60950-1-07 certified
IEC/EN60950-1 certified
IEC/EN60601-1 certified
CB Report

Description

Very high power density, 2:1 or 3:1 input voltage range and a wide operating temperature range -40°C to +71°C and extra features such as On/Off control are just some of the characteristics of this converter which is ideal for highly sophisticated industrial designs. The RS3 is available with 2kV or 3kV isolation options (1kVDC is standard).

Selection Guide

Part Number	nom. Input Voltage [VDC]	Output Voltage [VDC]	Output Current [mA]	Efficiency typ. [%]	max. Capacitive Load ⁽¹⁾ [µF]
RS3-xx3.3S	4.5-9, 9-18	3.3	600	73-75	4700
	18-36, 36-72			77-78	
RS3-xx05S	4.5-9, 9-18	5	600	76-79	4700
	18-36, 36-72			80-81	
RS3-xx09S	4.5-9, 9-18	9	333	77-80	3300
	18-36, 36-72			81-82	
RS3-xx12S	4.5-9, 9-18	12	250	80-81	2200
	18-36, 36-72			83	
RS3-xx15S	4.5-9, 9-18	15	200	80-81	2200
	18-36, 36-72			83	
RS3-xx3.3D	4.5-9, 9-18	±3.3	±300	73-75	±2200
	18-36, 36-72			75	
RS3-xx05D	4.5-9, 9-18	±5	±300	76-80	±2200
	18-36, 36-72			80-81	
RS3-xx09D	4.5-9, 9-18	±9	±167	77-81	±2200
	18-36, 36-72			81	
RS3-xx12D	4.5-9, 9-18	±12	±125	78-83	±1000
	18-36, 36-72			83	
RS3-xx15D	4.5-9, 9-18	±15	±100	79-83	±1000
	18-36, 36-72			83	
RS3-xx3.3SZ	9-27	3.3	600	73	4700
	20-60			74	
RS3-xx05SZ	9-27	5	600	76-79	4700
	20-60			78	
RS3-xx09SZ	9-27	9	333	77	3300
	20-60			79	
RS3-xx12SZ	9-27	12	250	80	2200
	20-60			80	
RS3-xx15SZ	9-27	15	200	80	2200
	20-60			80	
RS3-xx3.3DZ	9-27	±3.3	±300	73	±2200
	20-60			74	
RS3-xx05DZ	9-27	±5	±300	77	±2200
	20-60			78	
RS3-xx09DZ	9-27	±9	±167	79	±2200
	20-60			79	
RS3-xx12DZ	9-27	±12	±125	80	±1000
	20-60			80	
RS3-xx15DZ	9-27	±15	±100	80	±1000
	20-60			80	

Notes:

Note1: Maximum capacitive load is defined as the capacitive load that will allow start up in under 1 second without damage on the converter

Model Numbering



Notes:

Note2: add „Z“ for 3:1 Input Voltage (24= 9-27VDC or 48= 20-60VDC)

Note3: add suffix „/H2“ for 2kVDC isolation or „/H3“ for 3kVDC isolation, without suffix = standard 1kVDC isolation

Ordering Examples:

RS3-053.3S	4.5-9Vin	3.3Vout	Single	2:1 Input Voltage	1kVDC Isolation
RS3-1212D/H2	9-18Vin	±12Vout	Dual	2:1 Input Voltage	2kVDC Isolation
RS3-2415D/H3	9-27Vin	±15Vout	Dual	3:1 Input Voltage	3kVDC Isolation

Specifications (measured @ Ta= 25°C, nom. Vin, full load and after warm-up unless otherwise stated)

BASIC CHARACTERISTICS					
Parameter	Condition		Min.	Typ.	Max.
Input Voltage Range	2:1 Input	nom. Vin= 5VDC	4.5VDC		9VDC
		nom. Vin= 12VDC	9VDC		18VDC
	3:1 Input	nom. Vin= 24VDC	18VDC		36VDC
		nom. Vin= 48VDC	36VDC		72VDC
Quiescent Current		nom. Vin= 5VDC		35mA	
		nom. Vin= 12VDC		25mA	
		nom. Vin= 24VDC		20mA	
		nom. Vin= 48VDC		10mA	
Minimum Load (4)			10%		
ON/OFF CTRL		DC-DC ON		open or high impedance	
		DC-DC OFF		external V _{CTRL} = 5-12VDC + 1N4148 and 68Ω resistor	
Internal Operating Frequency		20% to 100% full load		200kHz	
Output Ripple and Noise		20MHz BW			50mVp-p

Notes:

Note4: Operation below 10% load won't harm the converter, but specifications may not be met

Efficiency vs. Load

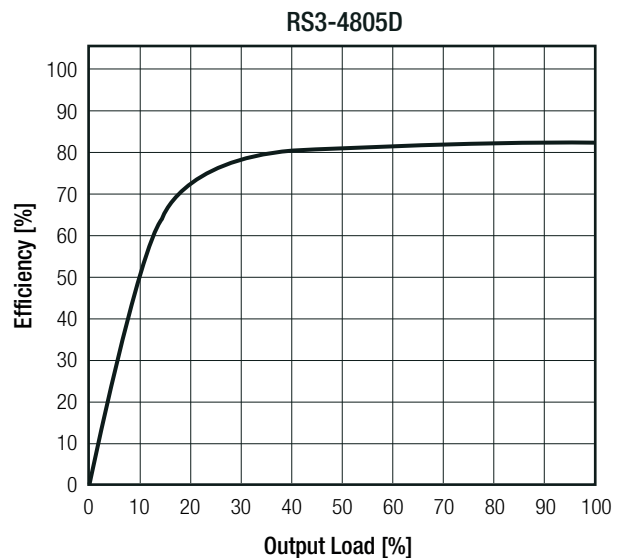
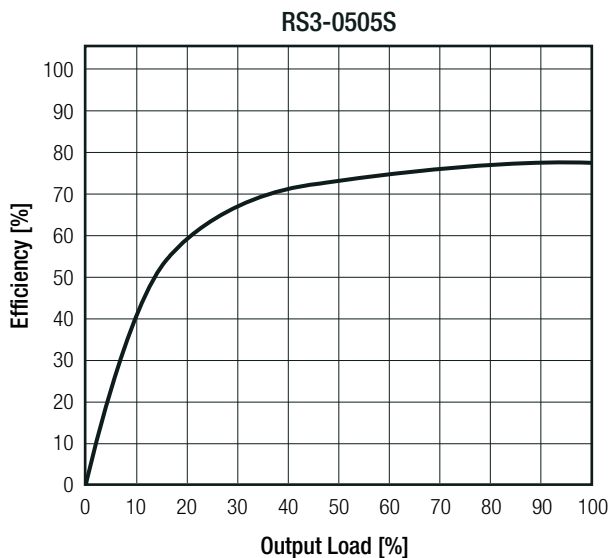

continued on next page

Specifications (measured @ Ta= 25°C, nom. Vin, full load and after warm-up unless otherwise stated)

ON/OFF CTRL

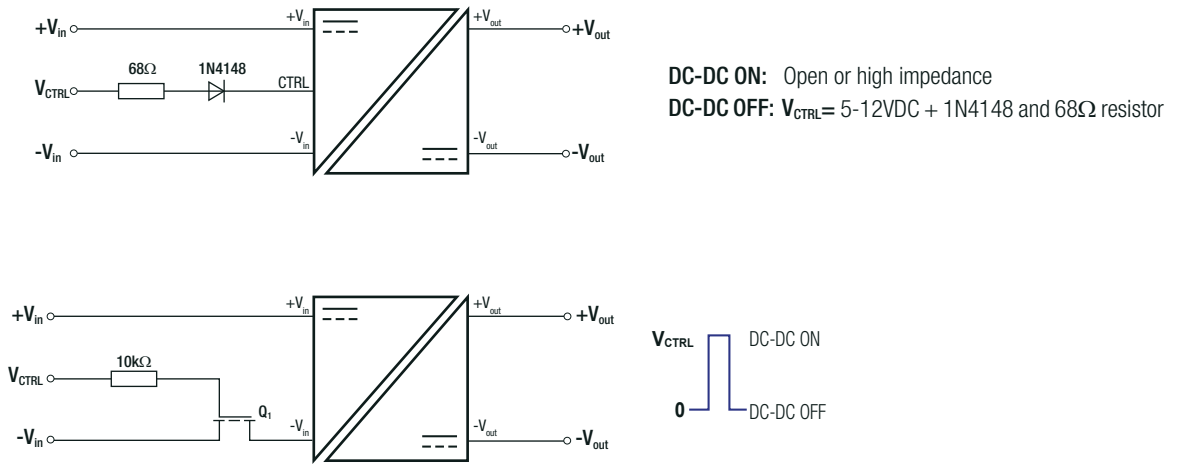

REGULATIONS

Parameter	Condition	Value
Output Accuracy		±2.0% typ.
Line Regulation	low line to high line, full load	±0.5% max.
Load Regulation	20% to 100% load	0.5% typ.

PROTECTIONS

Parameter	Type	Value
Short Circuit Protection (SCP)	below 100mΩ	continuous, auto recovery
Isolation Voltage ⁽⁵⁾	standard without suffix	tested for 1 second rated for 1 minute 1kVDC 500VAC/60Hz
	/H2 version	tested for 1 second rated for 1 minute 2kVDC 1kVAC/60Hz
	/H3 version	tested for 1 second rated for 1 minute 3kVDC 1.5kVAC/60Hz
Isolation Resistance		1GΩ min.
Isolation Capacitance	standard version without suffix /H2 and /H3 version	200pF max. 30pF max.
Insulation Grade		functional (CB-IEC/EN60601-1) basic (CB-IEC/EN60950-1)

Protection Circuit

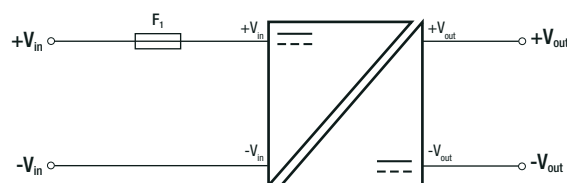

Notes:

- Note5: For repeat Hi-Pot testing, reduce the time and/or the test voltage
 Note6: To protect the converter under all fault conditions, an input fuse is required. Quick-fuses should be rated at 2x-3x the nominal input current, time -delay fuses at 1.5x the nominal input current

Specifications (measured @ Ta= 25°C, nom. Vin, full load and after warm-up unless otherwise stated)

ENVIRONMENTAL

Parameter	Condition		Value
Operating Temperature Range	full load @ free air convection (see graph)		-40°C to +71°C
Operating Altitude			5000m
Operating Humidity	non-condensing		95% RH max.
Pollution Degree			PD2
MTBF	according to MIL-HDBK-217F, G.B.	+25°C	3303 x 10 ³ hours
		+71°C	745 x 10 ³ hours

Derating Graph

(@ Chamber and free air convection)

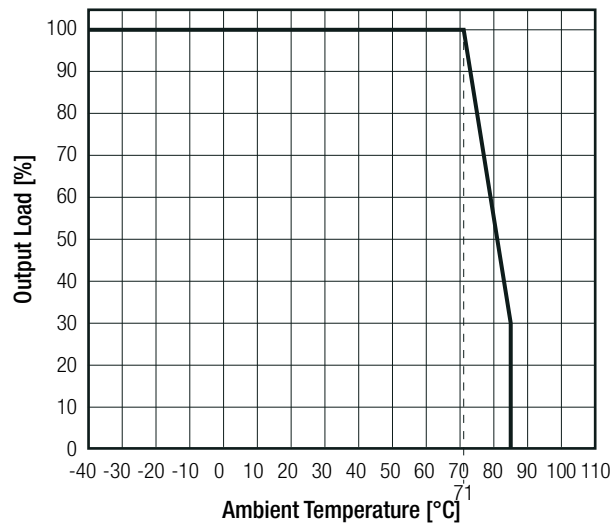

SAFETY AND CERTIFICATIONS

Certificate Type (Safety)	Report / File Number	Standard
Information Technology Equipment, General Requirements for Safety (LVD)	SPCLVD1605077-10	IEC60950-1, 2nd Edition, AM2: 2013 EN60950-1, 2nd Edition, A2:2013
Information Technology Equipment, General Requirements for Safety (CB)	L0339L49-CB-1-B1	IEC60950-1:2005, 2nd Edition + A2:2013
Information Technology Equipment, General Requirements for Safety	E224736-A33-UL	UL60950-1, 2nd Edition, 2014 CAN/CSA C22.2 No. 60950-1-07
Medical Electric Equipment, General Requirements for Safety and Essential Performance	WD-SE-R-180675-A0	IEC60601-1:2005 + C2:2007 + A1:2012, 3rd Edition EN60601-1:2006 + A1:2013 + A12:2014
EAC	RU-AT.AB49.B.09571	TP TC 004/2011
RoHS2		RoHS 2011/65/EU + AM2015/863

EMC Compliance	Condition	Standard / Criterion
Electromagnetic compatibility of multimedia equipment - Emission requirements ⁽⁷⁾	with external filter (see filter suggestion below)	EN55032, Class A EN55032, Class B

continued on next page

Specifications (measured @ Ta= 25°C, nom. Vin, full load and after warm-up unless otherwise stated)

EMC Filtering Suggestions according to EN55032

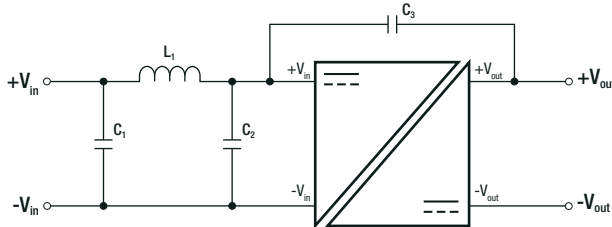

Notes:

Note8: Filter suggestions are valid for indicated part numbers only.
For other part numbers, please contact RECOM tech support for advice.

Component List Class A

MODEL	C1	C2, C3	L1
RS3-0505S	10µF	N/A	3.9µH choke RLS-397
RS3-0512S			
RS3-243.3S			
RS3-4805S			

Component List Class B

MODEL	C1	C2	C3	L1
RS3-0505S	10µF	N/A	N/A	5.6µH choke RLS-567
RS3-0512S				
RS3-243.3S		10µF	330pF	
RS3-4805S				

DIMENSION AND PHYSICAL CHARACTERISTICS

Parameter	Type	Value
Material	case potting PCB	non-conductive black plastic, (UL94V-0) epoxy, (UL94V-0) FR4, (UL94V-0)
Dimension (LxWxH)		21.8 x 9.2 x 11.1mm
Weight		4.7g typ.

Dimension Drawing (mm)

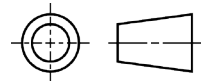
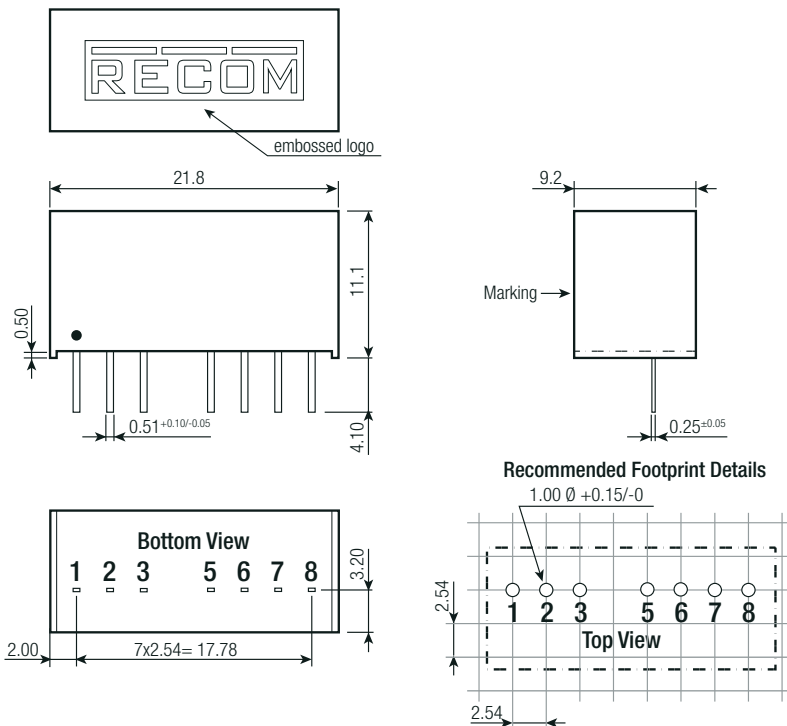

Pinning information

Pin #	Single	Dual
1	-Vin	-Vin
2	+Vin	+Vin
3	CTRL ^(®)	CTRL ^(®)
5	NC	NC
6	+Vout	+Vout
7	-Vout	Com
8	NC ^(®)	-Vout

NC= No Connection
Tolerances: xx.x ±0.5mm
xx.xx ±0.25mm

Notes:

Note8: This pin provides an Off function which puts the converter into a low power mode. When the pin is 'high' the converter is OFF and when the pin is open the converter is ON. There is no allowed low state for this pin. (refer to „ON/OFF CTRL“ on page 3)

Note9: This pin is used internally. No external connection allowed



Specifications (measured @ Ta= 25°C, nom. Vin, full load and after warm-up unless otherwise stated)

PACKAGING INFORMATION		
Parameter	Type	Value
Packaging Dimension (LxWxH)	tube	520.0 x 17.0 x 10.0mm
Packaging Quantity	tube	22pcs
Storage Temperature Range		-55°C to +125°C
Storage Humidity	non-condensing	95% RH max.

The product information and specifications may be subject to changes even without prior written notice. The product has been designed for various applications; its suitability lies in the responsibility of each customer. The products are not authorized for use in safety-critical applications without RECOM's explicit written consent. A safety-critical application is an application where a failure may reasonably be expected to endanger or cause loss of life, inflict bodily harm or damage property. The applicant shall indemnify and hold harmless RECOM, its affiliated companies and its representatives against any damage claims in connection with the unauthorized use of RECOM products in such safety-critical applications.

Looking for pricing, stock, or lifecycle information?

Click below to explore more details on WIN SOURCE:

-  [View RS3-1209S/H3 on WIN SOURCE](#)
-  [Recom Power Information](#)

Optimize Your Supply Chain with WIN SOURCE Solutions

-  Global Sourcing Solution
-  Obsolete Management
-  Cost Control Management
-  Shortage Management
-  Alternative Solution
-  Excess Inventory Management