



**THE DATASHEET OF
CY3203A-CAPSENSE**





CY3203A-CapSense Kit Quick Start

Spec. # 001-17826 Rev. *A

Cypress Semiconductor
198 Champion Court
San Jose, CA 95134-1709
Phone (USA): 800.858.1810
Phone (Intl): 408.943.2600
<http://www.cypress.com>



Copyrights

© Cypress Semiconductor Corporation, 2007. The information contained herein is subject to change without notice. Cypress Semiconductor Corporation assumes no responsibility for the use of any circuitry other than circuitry embodied in a Cypress product. Nor does it convey or imply any license under patent or other rights. Cypress products are not warranted nor intended to be used for medical, life support, life saving, critical control or safety applications, unless pursuant to an express written agreement with Cypress. Furthermore, Cypress does not authorize its products for use as critical components in life-support systems where a malfunction or failure may reasonably be expected to result in significant injury to the user. The inclusion of Cypress products in life-support systems application implies that the manufacturer assumes all risk of such use and in doing so indemnifies Cypress against all charges.

Any Source Code (software and/or firmware) is owned by Cypress Semiconductor Corporation (Cypress) and is protected by and subject to worldwide patent protection (United States and foreign), United States copyright laws and international treaty provisions. Cypress hereby grants to licensee a personal, non-exclusive, non-transferable license to copy, use, modify, create derivative works of, and compile the Cypress Source Code and derivative works for the sole purpose of creating custom software and or firmware in support of licensee product to be used only in conjunction with a Cypress integrated circuit as specified in the applicable agreement. Any reproduction, modification, translation, compilation, or representation of this Source Code except as specified above is prohibited without the express written permission of Cypress.

Disclaimer: CYPRESS MAKES NO WARRANTY OF ANY KIND, EXPRESS OR IMPLIED, WITH REGARD TO THIS MATERIAL, INCLUDING, BUT NOT LIMITED TO, THE IMPLIED WARRANTIES OF MERCHANTABILITY AND FITNESS FOR A PARTICULAR PURPOSE. Cypress reserves the right to make changes without further notice to the materials described herein. Cypress does not assume any liability arising out of the application or use of any product or circuit described herein. Cypress does not authorize its products for use as critical components in life-support systems where a malfunction or failure may reasonably be expected to result in significant injury to the user. The inclusion of Cypress' product in a life-support systems application implies that the manufacturer assumes all risk of such use and in doing so indemnifies Cypress against all charges.

Use may be limited by and subject to the applicable Cypress software license agreement.

PSoC Designer™, Programmable System-on-Chip™, and PSoC Express™ are trademarks and PSoC® is a registered trademark of Cypress Semiconductor Corp. All other trademarks or registered trademarks referenced herein are property of the respective corporations.>

Flash Code Protection

Cypress products meet the specifications contained in their particular Cypress PSoC Data Sheets. Cypress believes that its family of PSoC products is one of the most secure families of its kind on the market today, regardless of how they are used. There may be methods, unknown to Cypress, that can breach the code protection features. Any of these methods, to our knowledge, would be dishonest and possibly illegal. Neither Cypress nor any other semiconductor manufacturer can guarantee the security of their code. Code protection does not mean that we are guaranteeing the product as "unbreakable."

Cypress is willing to work with the customer who is concerned about the integrity of their code. Code protection is constantly evolving. We at Cypress are committed to continuously improving the code protection features of our products.

Contents



| | |
|---|-----------|
| 1. Getting Started | 5 |
| Install PSoC Express Development Software..... | 5 |
| Additional Content on CD..... | 5 |
| CY3203-CapSense Board Details | 6 |
| 2. Use the Board as Factory Programmed | 7 |
| Power the Board | 7 |
| Test the Board | 8 |
| Resetting the Board to the Original Factory Programming | 8 |
| 3. Create a CapSense Project | 9 |
| Start a New Project..... | 9 |
| Add a CSA Slider Driver to Your Design | 9 |
| Add an LCD Value Driver to Your Design..... | 10 |
| Define the LCD Transfer Function | 10 |
| Build Your Project..... | 11 |
| Assign Drivers to Pins..... | 12 |
| Program the CY3203 Board | 13 |
| Test the Board | 13 |
| What's Next? | 13 |
| 4. Tune a CapSense Project | 15 |
| Open Your PSoC Express Project..... | 15 |
| Add an I2C Slave Driver to Your Design | 15 |
| Build the Project..... | 15 |
| Assign Drivers to Pins..... | 16 |
| Program the CY3203 Board | 17 |
| Tune the Slider | 17 |
| 5. Design Support and Resources | 19 |
| PSoC Development Software Online..... | 19 |
| PSoC Data Sheets and Application Notes..... | 19 |
| PSoC Device Selector Guide..... | 19 |
| PSoC Development Tools Selector Guide..... | 19 |
| PSoC On-Demand Training | 19 |
| PSoC On-Site Training | 19 |
| Online Technical Support | 19 |
| Additional CapSense Resources | 20 |



Contents

1. Getting Started



Install PSoC Express Development Software

- 1.1. Insert the PSoC Development Software Suite CD into your CD-ROM drive.
- 1.2. Install PSoC Express.
- 1.3. Install .NET Framework 2.0.
- 1.4. Install PSoC Programmer.
- 1.5. Install Express Pak 1.







For the latest versions of all Cypress software, go to www.cypress.com.



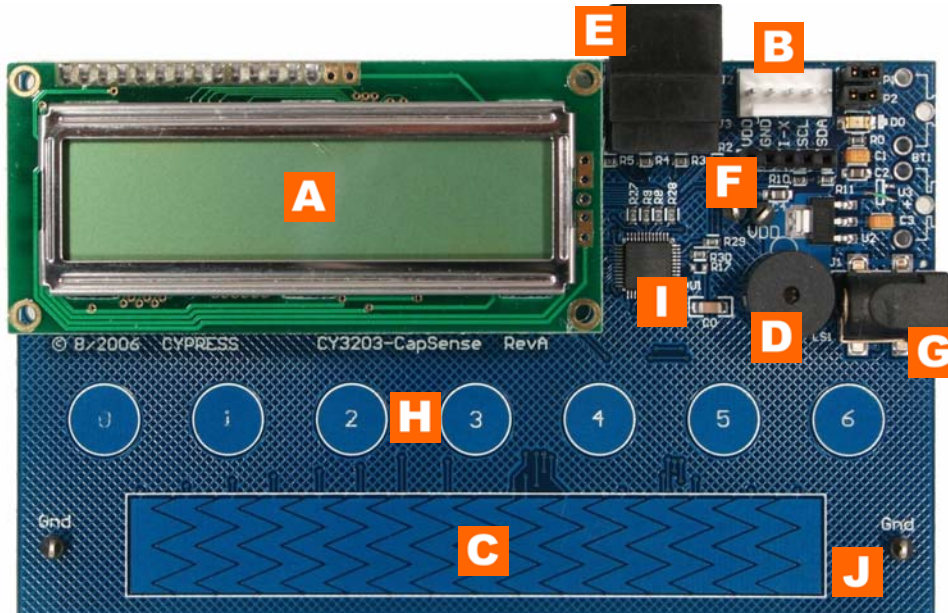



Additional Content on CD

- 1.6. Kit Documentation
- 1.7. Application Notes
- 1.8. Design Files
- 1.9. Schematics

CY3203-CapSense Board Details



| | | | | | | | | | | | | | | | | | |
|--|---|-----------------|-----------------|-----------------|-----------------|------------------|-----------------|------------------|-----------------|------------------|-----------------|------------------|-----------------|------------------|-----------------|------------------|-----------------|
| <p>LCD: 16x2 Dot Matrix LCD. Hitachi 44780 compatible model.</p> <p>LCD DB4 —P2[0] LCD DB5 —P2[1] LCD DB6 —P2[2] LCD DB7 —P2[3]</p> <p>LCD E —P2[4] LCD RS —P2[5] LCD R/W —P2[6]</p> |  <p>A</p> | | | | | | | | | | | | | | | | |
| <p>ISSP Connector (J2): In-System Serial Programmer (ISSP) connector. Connect MiniProg for Programming or I²C USB Bridge for monitoring.</p> <p>Data, Clock, Ground and VDD are all labeled. Data is routed to P1[0] and Clock is routed to P1[1].</p> |  <p>B</p> | | | | | | | | | | | | | | | | |
| <p>CapSense Slider: 16 CapSense slider pads are routed to the following I/O (Slider 8-15 are not shown in CSA Wizard):</p> <table border="0"> <tr> <td>Slider 0 —P0[0]</td> <td>Slider 8 —P0[0]</td> </tr> <tr> <td>Slider 1 —P0[1]</td> <td>Slider 9 —P2[0]</td> </tr> <tr> <td>Slider 2 —P0[2]</td> <td>Slider 10 —P0[6]</td> </tr> <tr> <td>Slider 3 —P2[7]</td> <td>Slider 11 —P0[1]</td> </tr> <tr> <td>Slider 4 —P0[4]</td> <td>Slider 12 —P0[4]</td> </tr> <tr> <td>Slider 5 —P0[5]</td> <td>Slider 13 —P0[7]</td> </tr> <tr> <td>Slider 6 —P0[6]</td> <td>Slider 14 —P0[2]</td> </tr> <tr> <td>Slider 7 —P0[7]</td> <td>Slider 15 —P0[5]</td> </tr> </table> <p>For more information on Slider Diplexing, please see application note AN2292 and the CSA User Module datasheet.</p>  | Slider 0 —P0[0] | Slider 8 —P0[0] | Slider 1 —P0[1] | Slider 9 —P2[0] | Slider 2 —P0[2] | Slider 10 —P0[6] | Slider 3 —P2[7] | Slider 11 —P0[1] | Slider 4 —P0[4] | Slider 12 —P0[4] | Slider 5 —P0[5] | Slider 13 —P0[7] | Slider 6 —P0[6] | Slider 14 —P0[2] | Slider 7 —P0[7] | Slider 15 —P0[5] | <p>C</p> |
| Slider 0 —P0[0] | Slider 8 —P0[0] | | | | | | | | | | | | | | | | |
| Slider 1 —P0[1] | Slider 9 —P2[0] | | | | | | | | | | | | | | | | |
| Slider 2 —P0[2] | Slider 10 —P0[6] | | | | | | | | | | | | | | | | |
| Slider 3 —P2[7] | Slider 11 —P0[1] | | | | | | | | | | | | | | | | |
| Slider 4 —P0[4] | Slider 12 —P0[4] | | | | | | | | | | | | | | | | |
| Slider 5 —P0[5] | Slider 13 —P0[7] | | | | | | | | | | | | | | | | |
| Slider 6 —P0[6] | Slider 14 —P0[2] | | | | | | | | | | | | | | | | |
| Slider 7 —P0[7] | Slider 15 —P0[5] | | | | | | | | | | | | | | | | |
| <p>Loudspeaker (LS1): Magnetic buzzer accessible via LS1. CEM-1206S. (Active high, set to drive strong, drive high.)</p> |  <p>D</p> | | | | | | | | | | | | | | | | |

| | | | | | | | | | |
|---|---|-----------------|-----------------|-----------------|-----------------|-----------------|-----------------|--|-----------------|
| <p>ICE-Cube Connector (J3): Connects to blue cat5e cable for use with ICE-Cube (available in the CY3215-DK).</p> |  <p>E</p> | | | | | | | | |
| <p>I2C Monitoring (J5): Data, Clock, Ground and VDD are all labeled. Data is routed to P1[5] and Clock is routed to P1[7]. (The I2C interrupt is not connected at this time.)</p> |  <p>F</p> | | | | | | | | |
| <p>Power Supply Connector: Connect a 9-12V power supply to power the board. (Recommended Digikey Part T561-P5P-ND.)</p> |  <p>G</p> | | | | | | | | |
| <p>CapSense Buttons: Seven CapSense button pads are routed to the following I/O:</p> <table border="0"> <tr> <td>Button 0 —P1[2]</td> <td>Button 4 —P3[3]</td> </tr> <tr> <td>Button 1 —P1[4]</td> <td>Button 5 —P3[0]</td> </tr> <tr> <td>Button 2 —P1[6]</td> <td>Button 6 —P1[3]</td> </tr> <tr> <td>Button 3 —P3[2]</td> <td></td> </tr> </table>  | Button 0 —P1[2] | Button 4 —P3[3] | Button 1 —P1[4] | Button 5 —P3[0] | Button 2 —P1[6] | Button 6 —P1[3] | Button 3 —P3[2] | | <p>H</p> |
| Button 0 —P1[2] | Button 4 —P3[3] | | | | | | | | |
| Button 1 —P1[4] | Button 5 —P3[0] | | | | | | | | |
| Button 2 —P1[6] | Button 6 —P1[3] | | | | | | | | |
| Button 3 —P3[2] | | | | | | | | | |
| <p>Modification Capacitor C0: C0 is port assignment P0[3].</p> |  <p>I</p> | | | | | | | | |
| <p>Test Points: Several Ground and VDD.</p> |  <p>J</p> | | | | | | | | |

Note: The PSoC part used on this evaluation board is different than the parts you will use in your designs.

2. Use the Board as Factory Programmed



Note: The CY3203A board is preprogrammed as an LCD with seven buttons and a slider. When powered by a PSoC MiniProg, the LCD displays a graphical representation of the button(s) that are being pressed and where the finger is at on the slider.

These instructions assume your board has not been reprogrammed from the factory settings. If it has, and you would like to follow along with this demonstration, follow the instructions in the [Resetting the Board to the Original Factory Programming section on page 8](#), and then start this example with the [Power the Board section](#) below.

Power the Board



- 2.1. Connect your computer to the CapSense test board ISSP Connector (J2) using the PSoC MiniProg and a USB cable. If this is your first time using the MiniProg, you will need to install the driver using these steps before proceeding:
 - a. When the Found New Hardware Wizard opens, select one of the **Yes** options and click **Next**.
 - b. Select the **Install the software automatically (Recommended)** option and click **Next**.
 - c. A warning message may tell you the software you are trying to install has not passed Windows Logo testing. Click **Continue Anyway** each time it appears.
 - d. When the installation is complete, click **Finish**.
- 2.2. Open **PSoC Programmer** by going to the Windows Start menu and selecting **All Programs → Cypress MicroSystems → PSoC Programming → PSoC Programmer**.

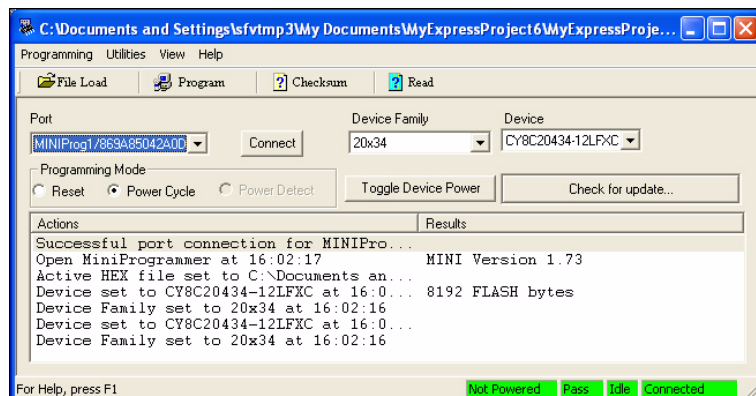

- 2.3. From the Port menu, select **MiniProg1/<Identification Code>**.

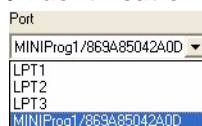

- 2.4. Click **Toggle Device Power**. The D0 LED on the board lights red.



Test the Board

- 2.5. Touch the slider on the board with your finger. The LCD shows the hexadecimal number representing where your finger is on the slider. The block on the LCD changes position as you move your finger across the slider.



- 2.6. Touch one button at a time with your finger. The LCD shows the hexadecimal number representing the button being pressed.



Resetting the Board to the Original Factory Programming

Follow these steps if you wish to reset the board to the original factory installed programming:

- 2.7. Download the CSA_7_Button_Slider example project at:
<http://www.cypress.com/design/DK10068>
- 2.8. To reset the board to the factory conditions, connect your computer to the CapSense test board ISSP Connector (J2) using the PSoC MiniProg and a USB cable.
- 2.9. Open **PSoC Programmer** by going to the **Windows Start** menu and selecting:
All Programs → Cypress Microsystems → PSoC Programming → PSoC Programmer
- 2.10. Click **File Load**, navigate to, and open the *csa_7_button_slider.hex* file at:
CSA_7_Button_Slider/output/csa_7_button_slider.hex
- 2.11. From the Device Family menu, select **20x34**.
- 2.12. From the Device menu, select **CY8C20434-12LFXC**.
- 2.13. Click **Program**. "Programming Succeeded..." appears in the Actions pane when programming is complete.



Note: The CSA_7_Button_Slider example project is a PSoC Designer project, and will not open with PSoC Express. PSoC Programmer uses .hex files generated with both PSoC Express and PSoC Designer.

3. Create a CapSense Project



This project walks you through the steps of creating a PSoC Express project from scratch. At the end of the project, you will be able to touch a button or the slider on the board and see the results on the LCD screen.

Start a New Project

- 3.1. Open PSoC Express 3.
- 3.2. Select **File** → **New Project**.
- 3.3. Name the project **MyExpressProject**.
- 3.4. If needed, click **Browse** to save the project in a different location.
- 3.5. Click **OK**.

Add a CSA Slider Driver to Your Design

- 3.6. Ensure the Driver Catalog pane is visible by selecting **View** → **Driver Catalog**.
- 3.7. Each driver and valuator has certain properties associated with it. For the purposes of this example, ensure **View** → **Use Add Driver Dialog** is checked.

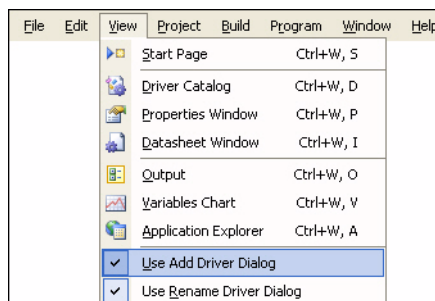

- 3.8. In the Driver Catalog pane, go to **Inputs** → **CapSense** → **CapSense - CSA**, right-click on **Slider - CSA**, and select **Add to Design**. The Add Input Driver window will open.

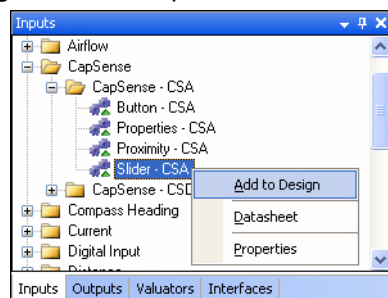

Inputs Tab

- 3.9. In the Add Input Driver window, name the driver **Slider**.

Create a CapSense Project

- 3.10. In the properties pane at the bottom of the window, set the Diplexing field to **Enable**.

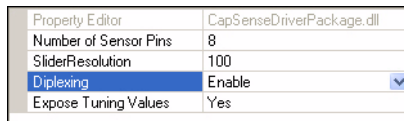

- 3.11. Click **OK**. The CSA Slider Properties window will open.



- 3.1. Click **OK** to accept the default settings. Another Add Input Driver window will open automatically.
- 3.2. Name this driver **CapSenseProperties**.
- 3.3. In the Properties pane, set ExternalCap to **Enabled**.
- 3.4. Click **OK**.

Add an LCD Value Driver to Your Design

- 3.5. In the Driver Catalog pane, go to **Outputs** → **Display** → **LCD**, and add an **LCD Value** driver to your design. The Add Output Driver window will open.
- 3.6. In the Add Output Driver window, name the driver **LCD** and click **OK** to accept the default settings.

Define the LCD Transfer Function

- 3.7. You now have three drivers on your design desktop: Slider, LCD, and CapSenseProperties. Right-click the LCD driver and select **Transfer Function**.

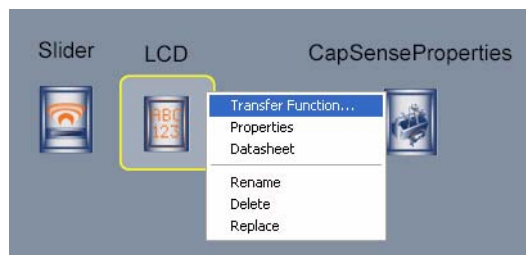

Note: If your driver icons are stacked on top of each other, simply use your mouse to click and drag each driver to a new location until all three drivers are clearly visible. You may also click your mouse button while holding the **[Ctrl]** or **[Ctrl] + [Shift]** keys to zoom in and out respectively.

- 3.8. In the Select Transfer Function window, select **PriorityEncoder** and click **OK**.

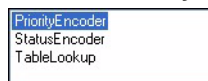

- 3.9. In the Priority Encoder Transfer Function window, type **1** in the If field. Click in the Then field, and select **Slider_Position** from the menu.

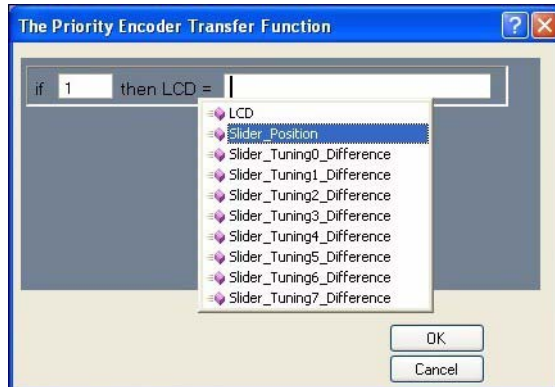

- 3.10. Click **OK**.

Build Your Project

- 3.11. Select **Build** → **Generate/Build 'MyExpressProject' Project**

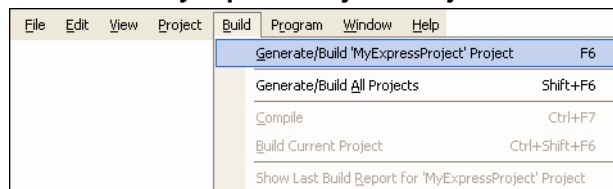

- 3.12. In the PSoC Device Configuration Selection window, select the **CY8C20434, 32-Pin QFN** part in the Available Device Configurations pane.



- 3.13. Ensure the **Assign pins automatically** check box is **NOT** selected.
 3.14. Click **Next**.

Assign Drivers to Pins

- 3.15. In the User Pin Assignment window, click **Unassign All Pins**. All drivers move to the Unassigned Drivers list.
- 3.16. To assign drivers to pins, drag and drop drivers from the Unassigned Drivers list onto a pin. Assign the CapSenseProperties_ExternalCap driver to port P0[3].

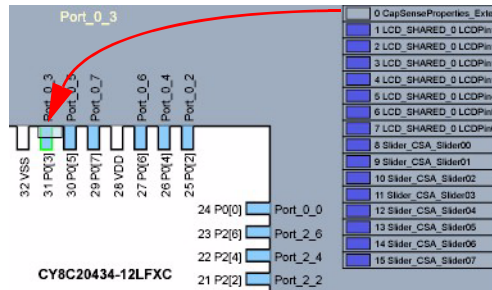

- 3.17. Assign the rest of the drivers according to the following table.

| | |
|--------------------------------|-------|
| CapSenseProperties_ExternalCap | P0[3] |
| LCD_SHARED_0LCDPin11 | P2[0] |
| Slider_CSA_Slider00 | P0[0] |
| Slider_CSA_Slider01 | P0[1] |
| Slider_CSA_Slider02 | P0[2] |
| Slider_CSA_Slider03 | P2[7] |
| Slider_CSA_Slider04 | P0[4] |
| Slider_CSA_Slider05 | P0[5] |
| Slider_CSA_Slider06 | P0[6] |
| Slider_CSA_Slider07 | P0[7] |

← **Note:** The LCD has more than one driver that must be assigned. PSoC Express Automatically assigns all the drivers for the LCD when the first driver is assigned to pin P2[0].

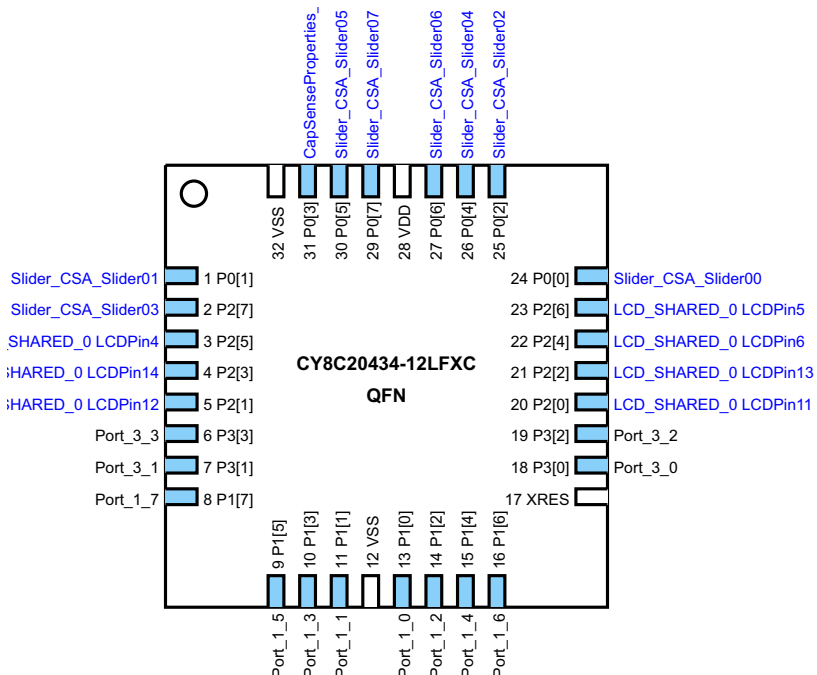

- 3.18. Click **Next**. PSoC Express builds your project (this may take a few minutes).

Program the CY3203 Board

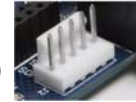

- 3.19. Connect your computer to the CapSense test board ISSP Connector (J2) using the PSoC MiniProg and a USB cable.

If this is your first time using the MiniProg, you will need to install the driver before proceeding. Follow the instructions in the [Power the Board section on page 7](#).

- 3.20. In PSoC Express, select **PSoC Programmer** from the Programmer menu. The PSoC Programmer application opens.

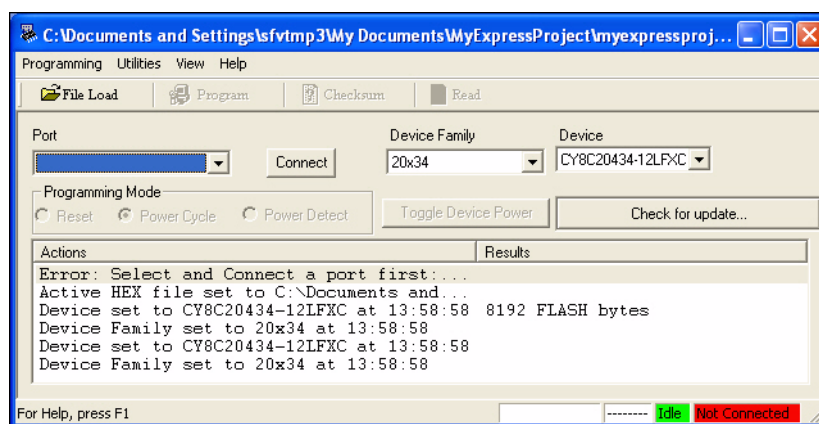
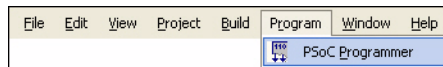

- 3.21. From the Port menu, select **MiniProg1/<Identification Code>**.

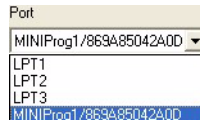

- 3.22. Click **Program**.

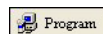

“Programming Succeeded...” appears in the Actions pane when programming is complete.

Test the Board

- 3.23. Click **Toggle Device Power**.



- 3.24. Touch the slider on the board with your finger. The LCD displays the position of your finger.

- 3.25. When you are done experimenting, click **Toggle Device Power**, and close PSoC Programmer.



- 3.26. Return to PSoC Express and select **File** → **Save Application**.

What’s Next?

You have now completed the PSoC Express CapSense project. The next example walks you through adjusting the settings so the slider is not as sensitive, a process known as tuning.



Create a CapSense Project

4. Tune a CapSense Project



Note: A CY3240 I²C Bridge is needed for CapSense Tuning. If you do not have an I²C Bridge board, purchase one online by going to <http://www.cypress.com/design/DK10063>, and clicking **Buy Online**.

The goal of tuning a capacitive sensing application is to adjust the sensitivity of the buttons or slider so that they accurately detect finger presses. This involves determining which raw counts coming from the sensor are actual finger presses, or if it is some other stimuli that changes the raw count.

Detailed tuning information is available in the CapSense Guide. In PSoC Express, select **Help** → **Documentation**, and select **CapSense Guide**.

Open Your PSoC Express Project

- 4.1. In PSoC Express, if the project from the previous example is closed, select **MyExpressProject** in the Recent Project pane (or click **browse** and open the project).
- 4.2. If you are not in the Design view, click Design .

Add an I²C Slave Driver to Your Design

- 4.3. In the Driver Catalog pane, go to **Interfaces** → **Communication** → **I²C**, and add a **Slave** driver to your design.
- 4.4. In the Add Interface window, name the driver **I²CSlave** and click **OK**.

Build the Project

- 4.5. Select **Build** → **Generate/Build 'MyExpressProject' Project**

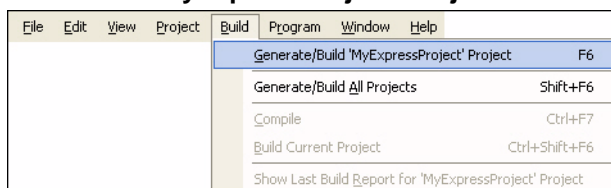

- 4.6. In the PSoC Device Configuration Selection window, select the **CY8C20434, 32-Pin QFN** part in the Available Device Configurations pane.



- 4.7. Ensure the **Assign pins automatically** check box is **NOT** selected.
- 4.8. Click **Next**.

Assign Drivers to Pins

- 4.9. In the User Pin Assignment window, click **Unassign All Pins**. All drivers move to the Unassigned Drivers list.
- 4.10. To assign drivers to pins, drag and drop drivers from the Unassigned Drivers list onto a pin. Assign the CapSenseProperties_ExternalCap driver to port P0[3].
- 4.11. Assign the rest of the drivers according to the following table.

| | |
|--------------------------------|-------|
| CapSenseProperties_ExternalCap | P0[3] |
| I2CSlave I2CSCLPin | P1[1] |
| LCD_SHARED_0LCDPin11 | P2[0] |
| Slider_CSA_Slider00 | P0[0] |
| Slider_CSA_Slider01 | P0[1] |
| Slider_CSA_Slider02 | P0[2] |
| Slider_CSA_Slider03 | P2[7] |
| Slider_CSA_Slider04 | P0[4] |
| Slider_CSA_Slider05 | P0[5] |
| Slider_CSA_Slider06 | P0[6] |
| Slider_CSA_Slider07 | P0[7] |

–**Note:** The LCD and I2C each have more than one driver that must be assigned. PSoC Express automatically assigns all the drivers for the LCD and I2C when the first driver for each is assigned to a pin.

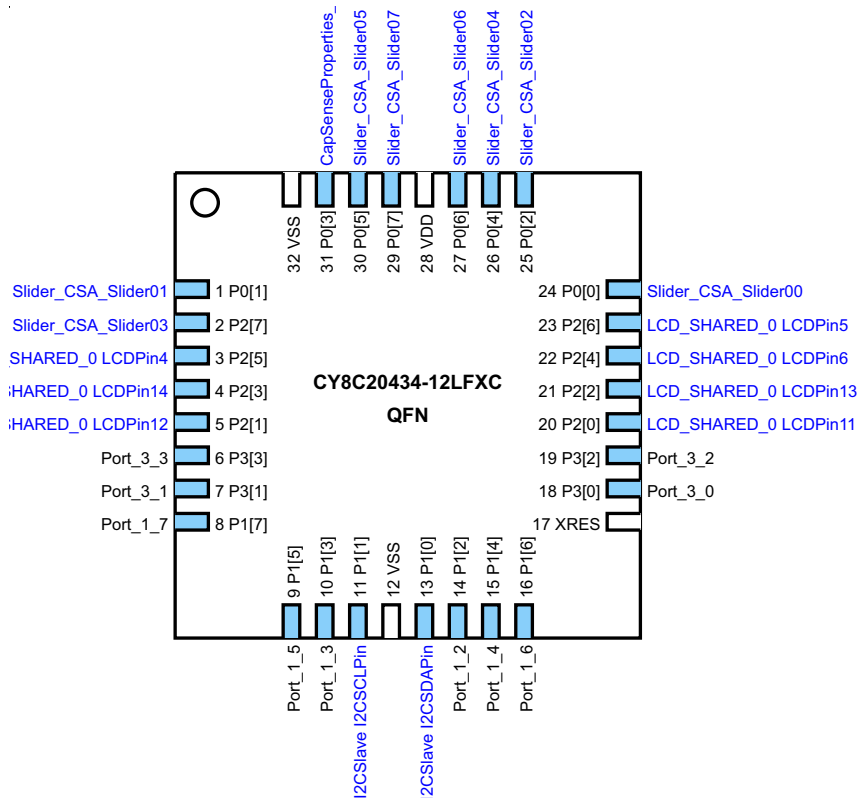

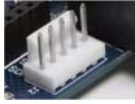

- 4.12. Click **Next**. PSoC Express builds your project (this may take a few minutes).

Program the CY3203 Board

- 4.13. Connect your computer to the CapSense test board ISSP Connector (J2)  using the PSoC MiniProg and a USB cable.
- 4.14. Select **Program** → **Programmer**. When PSoC Programmer opens, click **Program**.
- 4.15. When programming has successfully completed, close PSoC Programmer and return to PSoC Express.

Tune the Slider

- 4.16. Click the **Monitor**  button.
- 4.17. Connect your computer to the CapSense test board ISSP Connector (J2)  using the USB-I2C bridge and a USB cable.
- 4.18. From the Power Selection menu, select **5V Supplied**.

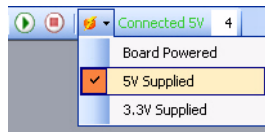

- 4.19. Click the **Start**  button.
- 4.20. Right-click the **Slider** driver and select **Show Tuner** to open the CSA Slider Tuner Window.

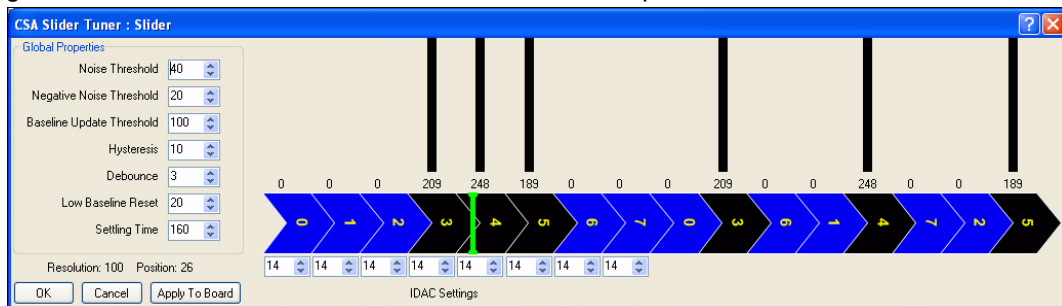

- 4.21. Touch the slider with your finger. You can easily see the slider is too sensitive because the sensors on the left and right of the middle sensor easily report a full-finger contact.
- 4.22. Increase the **IDAC** settings to **100**. Changing the IDAC setting is inversely related to the sensitivity of the button. Therefore, increasing the value decreases the sensitivity.
- 4.23. Click **Apply to Board** to write the changed parameter to Flash on the PSoC device.
- 4.24. Touch the slider with your finger. The slider is now less sensitive. Click **Stop** when you finish experimenting. Anytime that you are not actively using the board monitor you should stop it. Monitoring a design consumes a lot of processor cycles on your PC

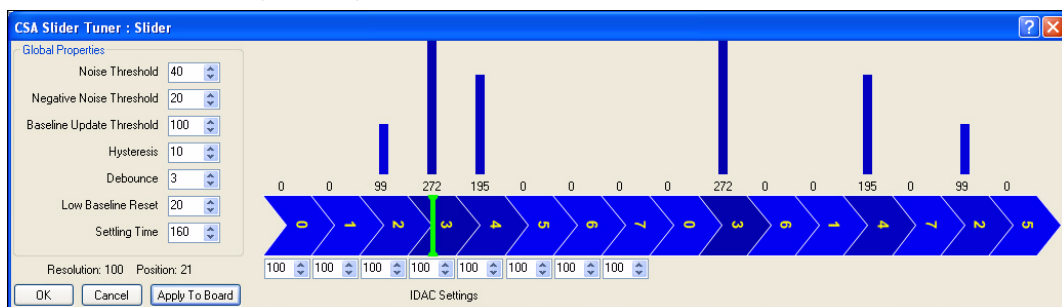

Congratulations! You have successfully completed this example. To experiment with additional CY3203 designs, go to the Start Page tab in PSoC Express, and look in the CY3203 CSA CapSense Kit folder in the Express Design Catalog pane.

Tune a CapSense Project



5. Design Support and Resources



PSoC Development Software Online

All PSoC development software tools are available for download online. For PSoC Express, visit www.cypress.com/psocexpress. For PSoC Designer visit www.cypress.com/psocdesigner. For PSoC Programmer visit www.cypress.com/psocprogrammer.

PSoC Data Sheets and Application Notes

For all PSoC device data sheets and detailed application notes, many with complete starter projects, visit www.cypress.com/designresources. In the Products column, select “PSoC Mixed-Signal Controllers” and in the Resource Type column, select either “Application Notes” or “Datasheets.”

PSoC Device Selector Guide

In the PSoC Application Notes section, search for [AN2209](#)—The Device Selection Guide for PSoC. It is a useful tool for determining exactly which PSoC device you should use for a specific design project.

PSoC Development Tools Selector Guide

In the PSoC Application Notes section, search for [AN2402](#), The PSoC Development Tools Selector Guide. This is a complete catalog and description of all the development tools that support PSoC devices and when to use them in your design cycle—from concept to production.

PSoC On-Demand Training

Visit www.cypress.com/psoctraining to engage in on-demand self-paced PSoC product and development software training. Learn to design PSoC like the pros, at the introductory, intermediate, and advanced knowledge levels!

PSoC On-Site Training

Visit www.cypress.com/psocseminars to sign up for a PSoC in-person training seminar at a location near you. Learn design basics, tips, and tricks from the pros to become a PSoC design expert!

Online Technical Support

For knowledge base articles, customer forums, and online application support, visit www.cypress.com/support.



Additional CapSense Resources

A wealth of information about PSoC Express and CapSense is available on the Cypress.com web site, and more is frequently added. The following list is just a sample of what is available.

CapSense DataSheets

- [CY8C20434 Mixed Signal Array](#)
- [CY8C20334 Mixed Signal Array](#)
- [CY8C20234 Mixed Signal Array](#)

CapSense Application Notes

- [AN2292, Layout Guidelines for PSoC™ CapSense](#)
- [AN2318, EMC Design Considerations for PSoC CapSense Applications](#)
- [AN2355, Calibrating CapSense with the CSR User Module](#)
- [AN2360, Power and Sleep Considerations](#)
- [AN2393, Migrating from CSR to CSA](#)
- [AN2394, CapSense Best Practices](#)
- [AN2397, CapSense Data Viewing Tool](#)
- [AN2398, Waterproof Capacitive Sensing](#)
- [AN2403, Signal-to-Noise Ratio Requirement for CapSense Applications](#)
- [AN2408, Migrating from CSR to CSD](#)
- [AN14459, CapSense Device and Method Selection Guide](#)

CapSense Technical Articles



- [TA1186, Designer's Guide to Rapid Prototyping of Capacitive Sensors on any Surface](#)
- [TA1179, Controls & Sensors Touch Sensors Spread Out](#)
- [TA1168, White Paper Cypress's CapSense Successive Approximation Algorithm](#)
- [TA1193, The Art of Capacitive Touch Sensing](#)

CapSense Developer Kits

- [DK10068, CapSense Successive Approximation \(CSA\)](#)
- [DK10069, CapSense Sigma-Delta \(CSD\)](#)
- [DK10064, CapSense Proximity Detection Demonstration](#)
- [DK10059, CapSense Demo Board](#)

Looking for pricing, stock, or lifecycle information?

Click below to explore more details on WIN SOURCE:

-  [View CY3203A-CAPSENSE on WIN SOURCE](#)
-  [Infineon Technologies](#) Information

Optimize Your Supply Chain with WIN SOURCE Solutions

-  Global Sourcing Solution
-  Obsolete Management
-  Cost Control Management
-  Shortage Management
-  Alternative Solution
-  Excess Inventory Management