



**THE DATASHEET OF
CY2XP21ZXIT**



125 MHz LVPECL Clock Generator

Features

- One LVPECL Output Pair
- Output Frequency: 112 MHz to 140 MHz
- External Crystal Frequency: 22.4 MHz to 28 MHz
- Low RMS Phase Jitter at 125 MHz, using 25 MHz Crystal (1.875 MHz to 20 MHz): 0.4 ps (Typical)
- Pb-free 8-Pin TSSOP Package
- Supply Voltage: 3.3V or 2.5V
- Commercial and Industrial Temperature Ranges

Functional Description

The CY2XP21 is a PLL (Phase Locked Loop) based high performance clock generator. It is optimized to generate a 125 MHz clock, which is ideal for 10 Gb Ethernet applications. It also produces an output frequency that is five times the crystal frequency. It uses Cypress's low noise VCO technology to achieve less than 1 ps typical RMS phase jitter. The CY2XP21 has a crystal oscillator interface input and one LVPECL output pair.

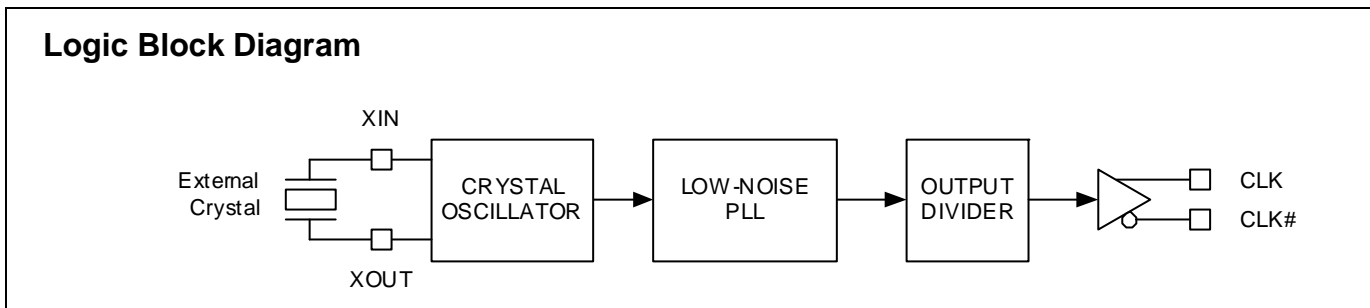

Pinouts

Figure 1. Pin Diagram - 8-Pin TSSOP



Table 1. Pin Definition - 8-Pin TSSOP

Pin Number	Pin Name	I/O Type	Description
1, 8	VDD	Power	3.3V or 2.5V power supply
2	VSS	Power	Ground
3, 4	XOUT, XIN	XTAL output and input	Parallel resonant crystal interface
5	NC		No Connect
6,7	CLK#, CLK	LVPECL output	Differential clock output

Frequency Table

Inputs		Output Frequency (MHz)
Crystal Frequency (MHz)	PLL Multiplier Value	
25	5	125
26.6	5	133

Absolute Maximum Conditions

Parameter	Description	Conditions	Min	Max	Unit
V _{DD}	Supply Voltage		-0.5	4.4	V
V _{IN} ^[1]	Input Voltage, DC	Relative to V _{SS}	-0.5	V _{DD} + 0.5	V
T _S	Temperature, Storage	Non operating	-65	150	°C
T _J	Temperature, Junction		-	135	°C
ESD _{HBM}	ESD Protection, Human Body Model	JEDEC STD 22-A114-B	2000	-	V
UL-94	Flammability Rating	At 1/8 in.	V-0		
Θ _{JA} ^[2]	Thermal Resistance, Junction to Ambient	0 m/s airflow	100		°C/W
		1 m/s airflow	91		
		2.5 m/s airflow	87		

Operating Conditions

Parameter	Description	Min	Max	Unit
V _{DD}	3.3V Supply Voltage	3.135	3.465	V
	2.5V Supply Voltage	2.375	2.625	V
T _A	Ambient Temperature, Commercial	0	70	°C
	Ambient Temperature, Industrial	-40	85	°C
T _{PU}	Power up time for all V _{DD} to reach minimum specified voltage (ensure power ramps is monotonic)	0.05	500	ms

DC Electrical Characteristics

Parameter	Description	Test Conditions	Min	Typ	Max	Unit
I _{DD}	Operating Supply Current with output unterminated	V _{DD} = 3.465V, Output unterminated	-	-	125	mA
		V _{DD} = 2.625V, Output unterminated	-	-	120	mA
I _{DDT}	Operating Supply Current with output terminated	V _{DD} = 3.465V, Output terminated	-	-	150	mA
		V _{DD} = 2.625V, Output terminated	-	-	145	mA
V _{OH}	LVPECL Output High Voltage	V _{DD} = 3.3V or 2.5V, R _{TERM} = 50Ω to V _{DD} - 2.0V	V _{DD} - 1.15	-	V _{DD} - 0.75	V
V _{OL}	LVPECL Output Low Voltage	V _{DD} = 3.3V or 2.5V, R _{TERM} = 50Ω to V _{DD} - 2.0V	V _{DD} - 2.0	-	V _{DD} - 1.625	V
V _{OD1}	LVPECL Peak-to-Peak Output Voltage Swing	V _{DD} = 3.3V or 2.5V, R _{TERM} = 50Ω to V _{DD} - 2.0V	600	-	1000	mV
V _{OD2}	LVPECL Output Voltage Swing (V _{OH} - V _{OL})	V _{DD} = 2.5V, R _{TERM} = 50Ω to V _{DD} - 1.5V	500	-	1000	mV

Notes

1. The voltage on any input or IO pin cannot exceed the power pin during power up.
2. Simulated using Apache Sentinel TI software. The board is derived from the JEDEC multilayer standard. It measures 76 x 114 x 1.6 mm and has 4-layers of copper (2/1/1/2 oz.). The internal layers are 100% copper planes, while the top and bottom layers have 50% metalization. No vias are included in the model.

DC Electrical Characteristics

Parameter	Description	Test Conditions	Min	Typ	Max	Unit
V _{OCM}	LVPECL Output Common Mode Voltage (V _{OH} + V _{OL})/2	V _{DD} = 2.5V, R _{TERM} = 50Ω to V _{DD} - 1.5V	1.2	–	–	V
C _{INX} ^[3]	Pin Capacitance, XIN & XOUT		–	4.5	–	pF

AC Electrical Characteristics^[3]

Parameter	Description	Conditions	Min	Typ	Max	Unit
F _{OUT}	Output Frequency		112	–	140	MHz
T _R , T _F	Output Rise or Fall Time	20% to 80% of full output swing	–	0.5	1.0	ns
T _{Jitter(φ)}	RMS Phase Jitter (Random)	125 MHz, (1.875–20 MHz)	–	0.4	–	ps
T _{DC}	Output Duty Cycle	Measured at zero crossing point	48	–	52	%
T _{LOCK}	Startup Time	Time for CLK to reach valid frequency measured from the time V _{DD} = V _{DD(min.)}	–	–	5	ms

Recommended Crystal Specifications^[4]

Parameter	Description	Min	Max	Unit
Mode	Mode of Oscillation	Fundamental		
F	Frequency	22.4	28	MHz
ESR	Equivalent Series Resistance	–	50	Ω
C ₀	Shunt Capacitance	–	7	pF

Parameter Measurements

Figure 2. 3.3V Output Load AC Test Circuit

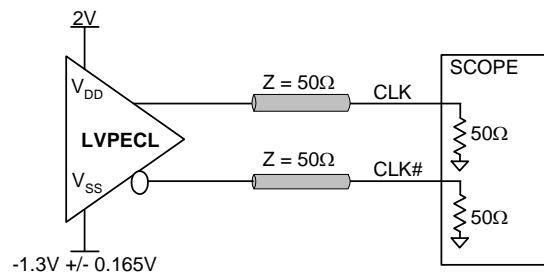

Notes

- 3. Not 100% tested, guaranteed by design and characterization.
- 4. Characterized using an 18 pF parallel resonant crystal.

Figure 3. 2.5V Output Load AC Test Circuit

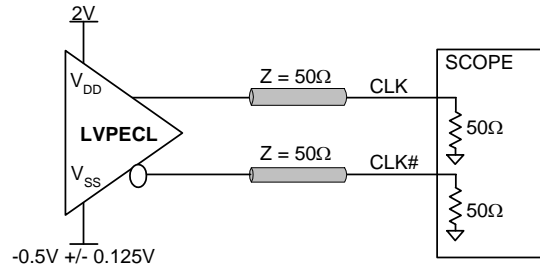

Figure 4. Output DC Parameters

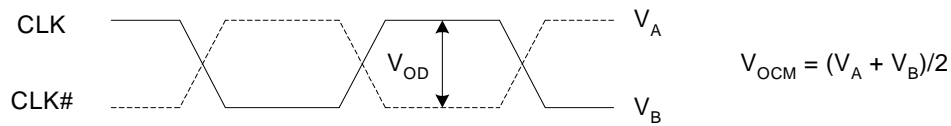

Figure 5. Output Rise and Fall Time

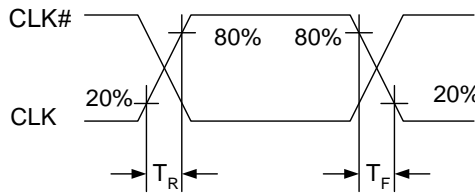

Figure 6. RMS Phase Jitter

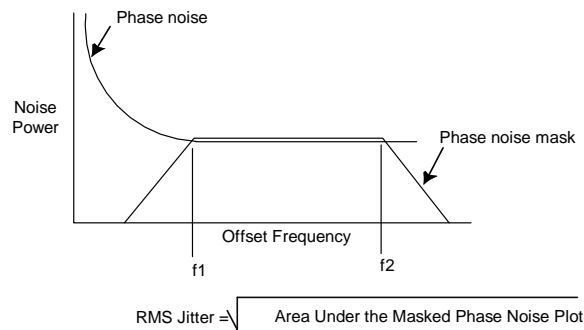
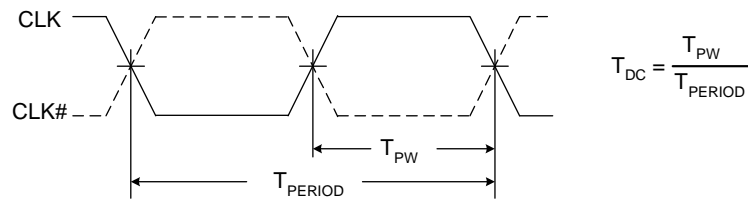

Figure 7. Output Duty Cycle



Application Information

Power Supply Filtering Techniques

As in any high speed analog circuitry, noise at the power supply pins can degrade performance. To achieve optimum jitter performance, use good power supply isolation practices. Figure 8 illustrates a typical filtering scheme. Since all the current flows through pin 1, the resistance and inductance between this pin and the supply is minimized. A 0.01 or 0.1 μF ceramic chip capacitor is also located close to this pin to provide a short and low impedance AC path to ground. A 1 to 10 μF ceramic or tantalum capacitor is located in the general vicinity of this device and may be shared with other devices.

Figure 8. Power Supply Filtering

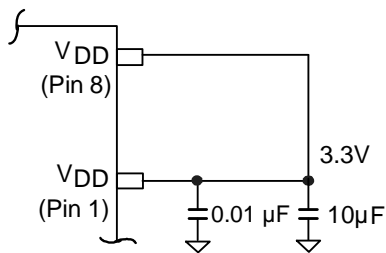

Termination for LVPECL Output

The CY2XP21 implements its LVPECL driver with a current steering design. For proper operation, it requires a 50 ohm dc termination on each of the two output signals. For 3.3V operation, this data sheet specifies output levels for termination to $V_{DD}-2.0\text{V}$. This same termination voltage can also be used for $V_{DD} = 2.5\text{V}$ operation, or it can be terminated to $V_{DD}-1.5\text{V}$. Note that it is also possible to terminate with 50 ohms to ground (V_{SS}), but the high and low signal levels differ from the data sheet values. Termination resistors are best located close to the destination device. To avoid reflections, trace characteristic impedance (Z_0) should match the termination impedance. Figure 9 shows a standard termination scheme.

Figure 9. LVPECL Output Termination

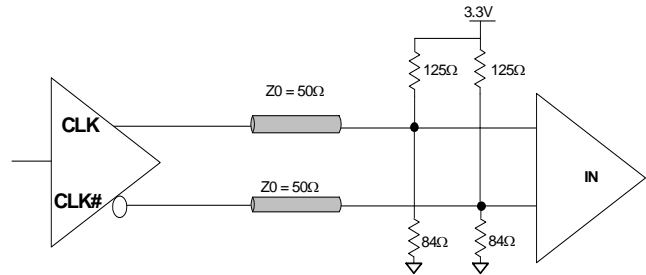

Crystal Interface

The CY2XP21 is characterized with 18 pF parallel resonant crystals. The capacitor values shown in Figure 10 are determined using a 25 MHz 18 pF parallel resonant crystal and are chosen to minimize the ppm error. Note that the optimal values for C1 and C2 depend on the parasitic trace capacitance and are thus layout dependent.

Figure 10. Crystal Input Interface

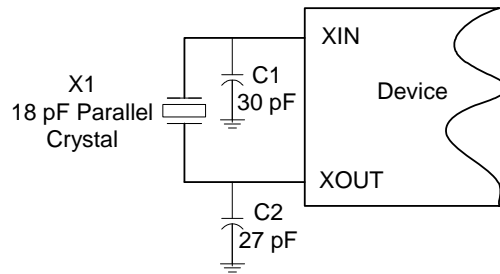

Board Layout and NC Pin

Pin 5 (NC) does not perform any function on the CY2XP21. Although not used electrically, it is very useful for heat dissipation. For this reason, users are advised to connect pin 5 to either a V_{DD} or V_{SS} plane. This helps to lower the thermal resistance of the board / package combination, thus reducing the die temperature.

Ordering Information

Part Number	Package Type	Product Flow
CY2XP21ZXC	8-pin TSSOP	Commercial, 0°C to 70°C
CY2XP21ZXCT	8-pin TSSOP - Tape and Reel	Commercial, 0°C to 70°C
CY2XP21ZXI	8-pin TSSOP	Industrial, -40°C to 85°C
CY2XP21ZXIT	8-pin TSSOP - Tape and Reel	Industrial, -40°C to 85°C

Package Drawing and Dimensions

Figure 11. 8-Pin Thin Shrink Small Outline Package (4.40 MM Body) Z8

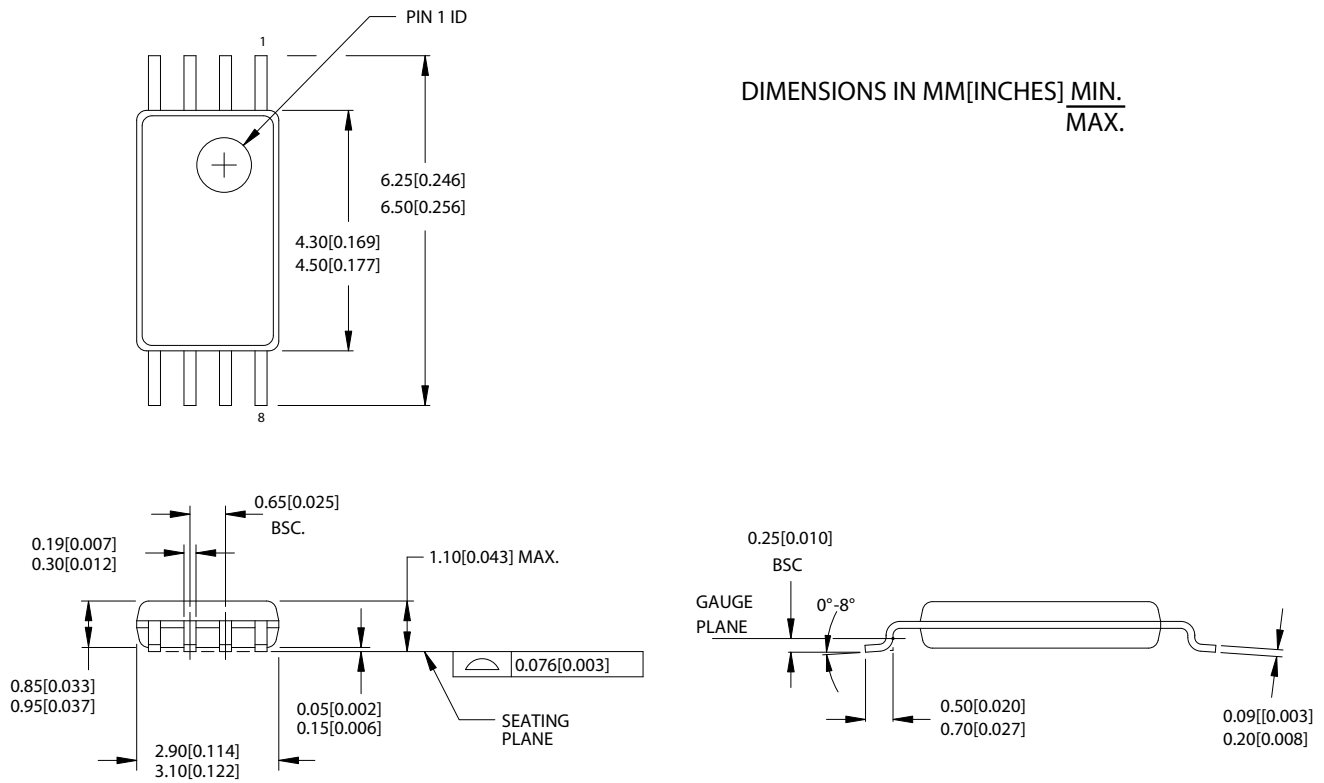

51-85093-A

Document History Page

Document Title: CY2XP21 125 MHz LVPECL Clock Generator Document Number: 001-52849				
REV.	ECN NO.	Submission Date	Orig. of Change	Description of Change
**	2700242	04/30/09	KVM/PYRS	New data sheet
*A	2718898	06/15/09	WWZ	Minor ECN to post data sheet to external web
*B	2767298	09/22/09	KVM	Add I _{DD} spec for unterminated outputs Change parameter name for I _{DD} (terminated outputs) from I _{DD} to I _{DDT} Remove I _{DD} footnote about externally dissipated current Add footnote reference to C _{INX} :not 100% tested Add max limit for T _R , T _F : 1.0 ns Change T _{LOCK} max from 10 ms to 5 ms

Sales, Solutions, and Legal Information

Worldwide Sales and Design Support

Cypress maintains a worldwide network of offices, solution centers, manufacturer's representatives, and distributors. To find the office closest to you, visit us at cypress.com/sales.

Products

PSoC	psoc.cypress.com
Clocks & Buffers	clocks.cypress.com
Wireless	wireless.cypress.com
Memories	memory.cypress.com
Image Sensors	image.cypress.com

© Cypress Semiconductor Corporation, 2009. The information contained herein is subject to change without notice. Cypress Semiconductor Corporation assumes no responsibility for the use of any circuitry other than circuitry embodied in a Cypress product. Nor does it convey or imply any license under patent or other rights. Cypress products are not warranted nor intended to be used for medical, life support, life saving, critical control or safety applications, unless pursuant to an express written agreement with Cypress. Furthermore, Cypress does not authorize its products for use as critical components in life-support systems where a malfunction or failure may reasonably be expected to result in significant injury to the user. The inclusion of Cypress products in life-support systems application implies that the manufacturer assumes all risk of such use and in doing so indemnifies Cypress against all charges.

Any Source Code (software and/or firmware) is owned by Cypress Semiconductor Corporation (Cypress) and is protected by and subject to worldwide patent protection (United States and foreign), United States copyright laws and international treaty provisions. Cypress hereby grants to licensee a personal, non-exclusive, non-transferable license to copy, use, modify, create derivative works of, and compile the Cypress Source Code and derivative works for the sole purpose of creating custom software and/or firmware in support of licensee product to be used only in conjunction with a Cypress integrated circuit as specified in the applicable agreement. Any reproduction, modification, translation, compilation, or representation of this Source Code except as specified above is prohibited without the express written permission of Cypress.

Disclaimer: CYPRESS MAKES NO WARRANTY OF ANY KIND, EXPRESS OR IMPLIED, WITH REGARD TO THIS MATERIAL, INCLUDING, BUT NOT LIMITED TO, THE IMPLIED WARRANTIES OF MERCHANTABILITY AND FITNESS FOR A PARTICULAR PURPOSE. Cypress reserves the right to make changes without further notice to the materials described herein. Cypress does not assume any liability arising out of the application or use of any product or circuit described herein. Cypress does not authorize its products for use as critical components in life-support systems where a malfunction or failure may reasonably be expected to result in significant injury to the user. The inclusion of Cypress' product in a life-support systems application implies that the manufacturer assumes all risk of such use and in doing so indemnifies Cypress against all charges.

Use may be limited by and subject to the applicable Cypress software license agreement.

Looking for pricing, stock, or lifecycle information?

Click below to explore more details on WIN SOURCE:

- ⊖ [View CY2XP21ZXIT on WIN SOURCE](#)
- ⊖ [Infineon Technologies](#) Information

Optimize Your Supply Chain with WIN SOURCE Solutions

- ✓ Global Sourcing Solution
- ✓ Obsolete Management
- ✓ Cost Control Management
- ✓ Shortage Management
- ✓ Alternative Solution
- ✓ Excess Inventory Management