



**THE DATASHEET OF
ACS37612LLUALU-010B3**



Coreless, High Precision, Hall-Effect Current Sensor IC with Common-Mode Field Rejection and High Bandwidth (240 kHz)

FEATURES AND BENEFITS

- Eliminates need for concentrator core or shield
- Suited for applications where current flows through busbar or PCB
- Very wide sensing range (2.5 to 20 mV/G)
 - Ideal for sensing currents from <200 A to >1000 A
- Factory-programmed segmented linear temperature compensation (TC) provides low thermal drift
 - Sensitivity $\pm 1\%$ (typ)
 - Offset ± 3 mV (typ)
- Differential Hall sensing rejects common-mode magnetic fields
- High operating bandwidth: DC to 240 kHz
- AEC-Q100 Grade 0, automotive qualified
- Contactless, lossless, non-invasive current sensing
- Very fast response time (< 2 μ s typ)
- 3.3 or 5.0 V single supply operation
- Ratiometric output with unidirectional and bidirectional modes
- Immune to mechanical stress
- Monolithic Hall IC for high reliability
- Wide ambient temperature range: -40°C to 150°C
- Surface mount, small footprint, low-profile TSSOP8 package

PACKAGE:

8-pin TSSOP package (suffix LU)

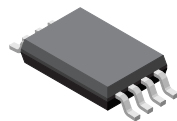

Not to scale

DESCRIPTION

The Allegro ACS37612 current sensor IC enables low-cost solutions for AC and DC current sensing without the need for an external field concentrator core or shield. It is designed for applications where hundreds of amps flow through a busbar or PCB.

Current flowing through a busbar or PCB trace generates a magnetic field that is sensed by the monolithic, low-offset, linear Hall IC. The differential sensing topology virtually eliminates all types of errors due to common-mode stray magnetic fields. High isolation is achieved via the no-contact nature of this simple assembly.

The ACS37612 is offered in 120 kHz and 240 kHz bandwidth options, making it ideal for inverter phase current sensing, load detection and management, power supplies, and DC/DC converters where fast switching is required. The fast response time enables overcurrent fault detection in safety-critical applications. A -40°C to 150°C ambient operating temperature range and a stellar ESD rating make it ready for harsh automotive environments.

The ACS37612 is suitable for space-constrained applications because of its low-profile 8-pin surface mount TSSOP package (thin-shrink small outline package, suffix LU) that is lead (Pb) free, with 100% matte tin leadframe plating.

TYPICAL APPLICATIONS

- High voltage traction motor inverter
- 48 V / 12 V auxiliary inverter
- Battery monitoring
- Overcurrent detection
- DC/DC converter
- Smart fuse
- Power distribution unit (PDU)
- Power supply

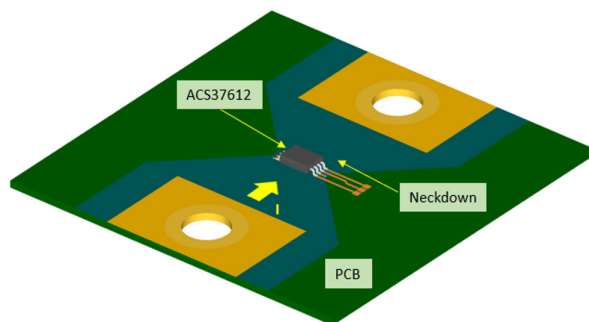

Figure 1: Current Through PCB

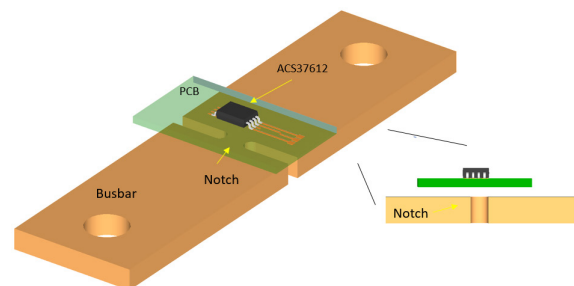

Figure 2: Current Through Busbar

ACS37612

Coreless, High Precision, Hall-Effect Current Sensor IC with Common-Mode Field Rejection and High Bandwidth (240 kHz)

SELECTION GUIDE

Part Number	Nominal Supply Voltage (V)	Differential Magnetic Input Range, (G)	Sensitivity Sens (Typ.) (mV/G) ^[1]	Bandwidth (kHz)	T _A (°C)	Packing ^[2]
ACS37612LLUATR-010B3	3.3	±135	10	120	-40 to 150	4000 pieces per 13-inch reel
ACS37612LLUATR-005B5	5	±400	5			
ACS37612LLUATR-010B5	5	±200	10			
ACS37612LLUATR-010B5-C	5	±200	10			
ACS37612LLUATR-015B5	5	±130	15			
ACS37612LLUATR-015U5	5	0 to 265	15			

^[1] Measured at nominal supply voltage. Contact Allegro for other sensitivity options.

^[2] Contact Allegro for additional packing options.

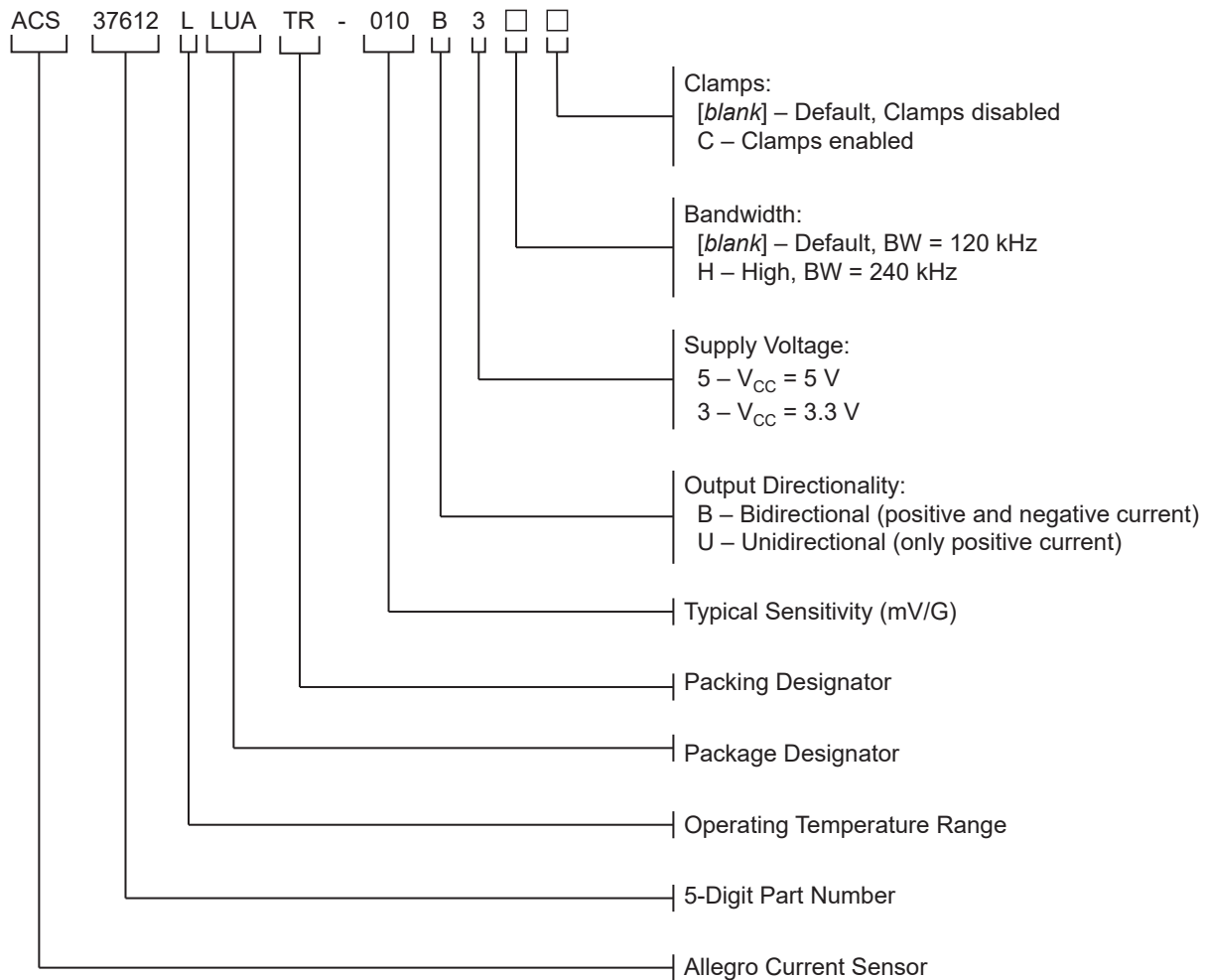

ABSOLUTE MAXIMUM RATINGS

Characteristic	Symbol	Notes	Rating	Unit
Supply Voltage	V_{CC}		6.5	V
Reverse Supply Voltage	V_{RCC}		-0.5	V
Output Voltage	V_{OUT}		6.5	V
Reverse Output Voltage	V_{ROUT}		-0.5	V
Output Source Current	$I_{OUT(Source)}$	VOUT to GND	3	mA
Output Sink Current	$I_{OUT(Sink)}$	Minimum pull-up resistor of 500 Ω	10	mA
Nominal Operating Ambient Temperature	T_A	Range L	-40 to 150	$^{\circ}C$
Maximum Junction Temperature	$T_{J(max)}$		165	$^{\circ}C$
Storage Temperature	T_{stg}		-65 to 165	$^{\circ}C$

ESD RATINGS

Characteristic	Symbol	Test Conditions	Value	Unit
Human Body Model	V_{HBM}	Per AEC-Q100	± 12	kV
Charged Device Model	V_{CDM}	Per AEC-Q100	± 1	kV

THERMAL CHARACTERISTICS: May require derating at maximum conditions; see application information

Characteristic	Symbol	Test Conditions [1]	Value	Unit
Package Thermal Resistance	$R_{\theta JA}$	LU package, on 4-layer PCB based on JEDEC standard	145	$^{\circ}C/W$

[1] Additional thermal information available on the Allegro website.

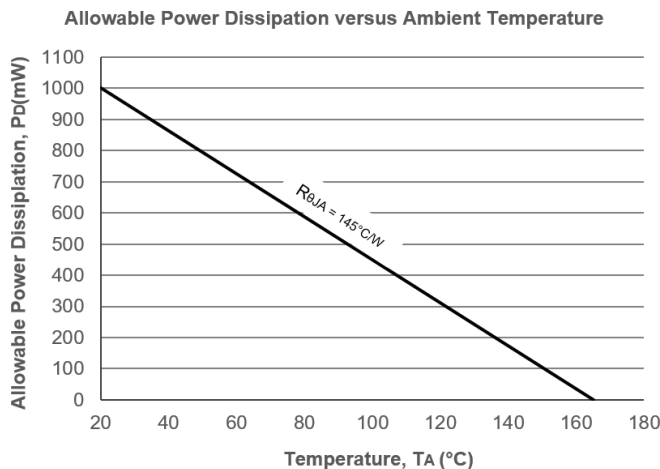

Figure 3: Allowable Power Dissipation

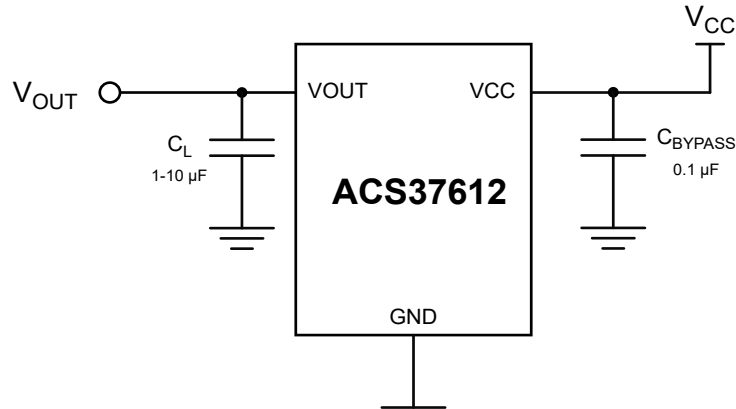

Figure 4: Typical Application Circuit

The ACS37612 outputs an analog signal, V_{OUT} , that varies linearly with the bi-directional AC or DC field sensed within the range specified. C_L is for optimal noise management, with values that depend on the application.

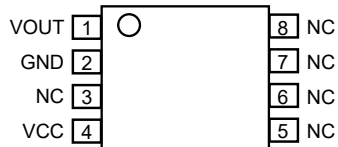

Figure 5: Pinout Diagram

Pinout List

Number	Name	Description
1	VOUT	Analog output signal, also used for programming
2	GND	Ground pin
3, 5, 6, 7, 8	NC	Not connect; tie to GND for optimal ESD performance
4	VCC	Input power supply, also used for programming

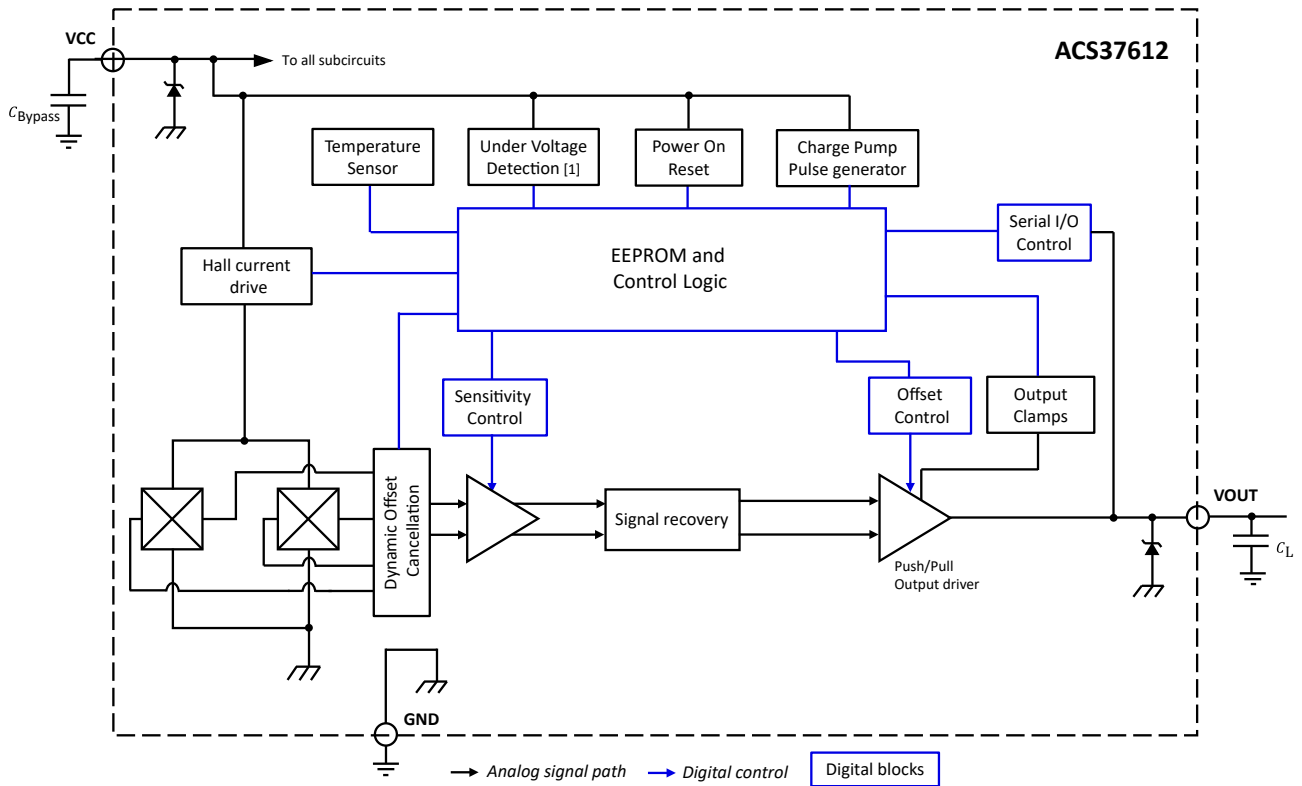

Figure 6: Functional Block Diagram

COMMON OPERATING CHARACTERISTICS: Valid through full range of T_A and V_{CC} , unless otherwise specified

Characteristic	Symbol	Test Conditions	Min.	Typ.	Max.	Unit	
ELECTRICAL CHARACTERISTICS							
Supply Voltage	V_{CC}	5 V nominal supply voltage variant	4.5	5	5.5	V	
		3.3 V nominal supply voltage variant	3	3.3	3.6	V	
Supply Current	I_{CC}	$V_{CC}(\min) \leq V_{CC} \leq V_{CC}(\max)$, where $V_{CC} = 5\text{ V or }3.3\text{ V}$, no load on output	–	12	16	mA	
Power-On Time	t_{PO}	$T_A = 25^\circ\text{C}$	–	70	–	μs	
Temperature Compensation Power-On Time	t_{TC}	$T_A = 25^\circ\text{C}$, C_L (of test probe) = 10 pF, $C_{BYPASS} = \text{open}$	–	45	–	μs	
Undervoltage Lockout (UVLO) Threshold ^[1]	V_{UVLOD}	V_{CC} rising; UVLO is disabled, enabling the device output; $T_A = 25^\circ\text{C}$	–	3.8	4.2	V	
	V_{UVLOE}	V_{CC} falling; UVLO is enabled, disabling the device output; $T_A = 25^\circ\text{C}$	3.45	3.7	–	V	
UVLO Hysteresis	$V_{UVLO(HYS)}$	$T_A = 25^\circ\text{C}$	–	100	–	mV	
UVLO Enable/Disable Delay Time	t_{UVLOE}	Time measured from falling $V_{CC} < V_{UVLOE}$ to UVLO enabled; $T_A = 25^\circ\text{C}$	–	74	–	μs	
	t_{UVLOD}	Time measured from rising $V_{CC} > V_{UVLOD}$ to UVLO disabled; $T_A = 25^\circ\text{C}$	–	7	–	μs	
Power-On Release Delay	t_{POR}	$T_A = 25^\circ\text{C}$, 3.3 V part variant only	–	7	–	μs	
Power-On Reset Voltage	V_{PORH}	$T_A = 25^\circ\text{C}$, V_{CC} rising	–	2.8	–	V	
	V_{PORL}	$T_A = 25^\circ\text{C}$, V_{CC} falling	–	2.5	–	V	
Power-On Reset Release Time	t_{PORR}	$T_A = 25^\circ\text{C}$, V_{CC} rising	–	64	–	μs	
Power-On Reset Hysteresis	$V_{HYS(POR)}$		–	250	–	mV	
Internal Bandwidth	BW_i	Small signal –3 dB, $C_L = 1\text{ nF}$, device programmed to lowest bandwidth mode (default)	–	120	–	kHz	
		Small signal –3 dB, $C_L = 1\text{ nF}$, device programmed to highest bandwidth mode	–	240	–	kHz	
Rise Time ^[2]	t_r	$T_A = 25^\circ\text{C}$, $C_L = 1\text{ nF}$	$BW_i = 240\text{ kHz}$	–	1.7	–	μs
			$BW_i = 120\text{ kHz}$	–	3.2	–	μs
Propagation Delay ^[2]	t_{PD}	$T_A = 25^\circ\text{C}$, $C_L = 1\text{ nF}$	$BW_i = 240\text{ kHz}$	–	1	–	μs
			$BW_i = 120\text{ kHz}$	–	1.5	–	μs
Response Time ^[2]	$t_{RESPONSE}$	$T_A = 25^\circ\text{C}$, $C_L = 1\text{ nF}$	$BW_i = 240\text{ kHz}$	–	1.6	–	μs
			$BW_i = 120\text{ kHz}$	–	3.2	–	μs
DC Output Impedance	R_{OUT}		–	< 1	–	Ω	
Output Load Resistance	R_L	VOUT to GND	4.7	10	–	k Ω	
Output Load Capacitance	C_L	VOUT to GND	–	1	10	nF	
Output Voltage Clamp (Clamp Enable Option Only)	$V_{CLP(HIGH)}$	$T_A = 25^\circ\text{C}$, $R_{L(PULLDOWN)} = 10\text{ k}\Omega$ to GND	$0.9 \times V_{CC}$	–	–	V	
	$V_{CLP(LOW)}$	$T_A = 25^\circ\text{C}$, $R_{L(PULLUP)} = 10\text{ k}\Omega$ to VCC	–	–	$0.1 \times V_{CC}$	V	
Delay to Clamp (Clamp Enable Option Only)	t_{CLP}	$T_A = 25^\circ\text{C}$; $C_L = 1\text{ nF}$; Step from 75% output range to 150%	–	5	–	μs	
Output Saturation Voltage (Clamp Disabled Option Only)	$V_{SAT(HIGH)}$	$T_A = 25^\circ\text{C}$, $R_{L(PULLDOWN)} = 10\text{ k}\Omega$ to GND	$V_{CC} - 0.2$	–	–	V	
	$V_{SAT(LOW)}$	$T_A = 25^\circ\text{C}$, $R_{L(PULLUP)} = 10\text{ k}\Omega$ to VCC	–	–	200	mV	

Continued on the next page...

COMMON OPERATING CHARACTERISTICS (continued): Valid through full range of T_A and V_{CC} , unless otherwise specified

Characteristic	Symbol	Test Conditions	Min.	Typ.	Max.	Unit
QUIESCENT OUTPUT VOLTAGE ($V_{OUT(Q)}$)						
Quiescent Output Voltage	$V_{OUT(Q)}$	Bidirectional variant, no magnetic field, $T_A = 25^\circ\text{C}$; $V_{OUT(Q)}$ ratiometric to V_{CC}	–	$0.5 \times V_{CC}$	–	V
		Unidirectional variant, no magnetic field, $T_A = 25^\circ\text{C}$; $V_{OUT(Q)}$ ratiometric to V_{CC}	–	$0.1 \times V_{CC}$	–	V
ERROR COMPONENTS						
Clamp Ratiometry Error	Rat_{ERRCLP}	$V_{CC} = \pm 5\%$ variation of nominal supply voltage	–	± 1.0	–	%
Noise	B_N	$T_A = 25^\circ\text{C}$, $C_L = 1 \text{ nF}$	–	2	–	$\text{mG}_{RMS} / \sqrt{\text{Hz}}$
Nonlinearity	E_{LIN}	Up to full-scale output	–1	± 0.45	1	%
Common Mode Field Rejection Ratio	CMFRR	Measured at 100 G uniform magnetic field	–	40	–	dB

[1] UVLO feature is available on parts with 5 V nominal supply voltage.

[2] Timing specified does not include potential effect of skin effect on conductor; value will depend on busbar/PCB design.

ACS37612LLUATR-005B5 PERFORMANCE CHARACTERISTICS: Valid over full range of T_A and $V_{CC} = 5 \text{ V}$, unless otherwise specified

Characteristic	Symbol	Test Conditions	Min.	Typ. [1]	Max.	Unit
NOMINAL PERFORMANCE						
Differential Magnetic Range	B_{DIFF}		–400	–	400	G
Sensitivity	Sens	$V_{CC}(\text{min}) \leq V_{CC} \leq V_{CC}(\text{max})$	–	5	–	mV/G
ACCURACY PERFORMANCE						
Noise	V_N	$T_A = 25^\circ\text{C}$, $C_L = 1 \text{ nF}$, BW = 120 kHz	–	4.5	–	mV_{RMS}
		$T_A = 25^\circ\text{C}$, $C_L = 1 \text{ nF}$, BW = 240 kHz	–	6.5	–	mV_{RMS}
Sensitivity Error	E_{SENS}	$T_A = 25^\circ\text{C}$	–2	± 1	2	%
Sensitivity Drift Over Temperature	ΔSens_{TC}	$T_A = 25^\circ\text{C}$ to 150°C	–2	± 1	2	%
		$T_A = -40^\circ\text{C}$ to 25°C	–2	± 1	2	%
Factory Quiescent Voltage Output Error	V_{OE}	$T_A = 25^\circ\text{C}$	–5	± 3	5	mV
Quiescent Voltage Output Temperature Error	$V_{OUT(Q)TC}$	$T_A = 25^\circ\text{C}$ to 150°C	–5	± 3	5	mV
		$T_A = -40^\circ\text{C}$ to 25°C	–5	± 3	5	mV
QVO Ratiometry Error	$V_{\text{RatERRQVO}}$	$V_{CC} = \pm 5\%$ variation of nominal supply voltage	–7.5	± 2.5	7.5	mV
Sens Ratiometry Error	$\text{Rat}_{ERRSens}$	$V_{CC} = \pm 5\%$ variation of nominal supply voltage	–1.25	± 0.5	1.25	%
LIFETIME DRIFT CHARACTERISTICS [2]						
QVO Lifetime Drift	$V_{QVOLife}$	$T_A = 25^\circ\text{C}$	–	1.4	–	mV
Sens Lifetime Drift	$\text{Sens}_{ERRLife}$	$T_A = 25^\circ\text{C}$	–	0.6	–	%
QVO TC Lifetime Drift	$V_{QVOTCLife}$	$T_A = 25^\circ\text{C}$ to 150°C	–	1.5	–	mV
Sens TC Lifetime Drift	Sens_{TCLife}	$T_A = 25^\circ\text{C}$ to 150°C	–	0.6	–	%

[1] All typical values are ± 3 sigma.

[2] Typical lifetime value corresponds to worse case average drift found during AEC-Q100 qualification.

ACS37612LLUATR-010B3 PERFORMANCE CHARACTERISTICS: Valid over full range of T_A and $V_{CC} = 3.3$ V, unless otherwise specified

Characteristic	Symbol	Test Conditions	Min.	Typ. [1]	Max.	Unit
NOMINAL PERFORMANCE						
Differential Magnetic Range	B_{DIFF}		-135	-	135	G
Sensitivity	Sens	$V_{CC}(\min) \leq V_{CC} \leq V_{CC}(\max)$	-	10	-	mV/G
ACCURACY PERFORMANCE						
Noise	V_N	$T_A = 25^\circ\text{C}$, $C_L = 1$ nF, BW = 120 kHz	-	9	-	mV _{RMS}
		$T_A = 25^\circ\text{C}$, $C_L = 1$ nF, BW = 240 kHz	-	12.5	-	mV _{RMS}
Sensitivity Error	E_{SENS}	$T_A = 25^\circ\text{C}$	-2	± 1	2	%
Sensitivity Drift Over Temperature	ΔSens_{TC}	$T_A = 25^\circ\text{C}$ to 150°C	-2	± 1	2	%
		$T_A = -40^\circ\text{C}$ to 25°C	-2	± 1	2	%
Factory Quiescent Voltage Output Error	V_{OE}	$T_A = 25^\circ\text{C}$	-5	± 3	5	mV
Quiescent Voltage Output Temperature Error	$V_{OUT(Q)TC}$	$T_A = 25^\circ\text{C}$ to 150°C	-10	± 3	10	mV
		$T_A = -40^\circ\text{C}$ to 25°C	-10	± 3	10	mV
QVO Ratiometry Error	$V_{RatERRQVO}$	$V_{CC} = \pm 3\%$ variation of nominal supply voltage	-15	± 5	15	mV
Sens Ratiometry Error	$Rat_{ERRSens}$	$V_{CC} = \pm 3\%$ variation of nominal supply voltage	-1.25	± 0.5	1.25	%
LIFETIME DRIFT CHARACTERISTICS [2]						
QVO Lifetime Drift	$V_{QVOLife}$	$T_A = 25^\circ\text{C}$	-	1.4	-	mV
Sens Lifetime Drift	$Sens_{ERRLife}$	$T_A = 25^\circ\text{C}$	-	0.6	-	%
QVO TC Lifetime Drift	$V_{QVOTCLife}$	$T_A = 25^\circ\text{C}$ to 150°C	-	1.5	-	mV
Sens TC Lifetime Drift	$Sens_{TCLife}$	$T_A = 25^\circ\text{C}$ to 150°C	-	0.6	-	%

[1] All typical values are ± 3 sigma.

[2] Typical lifetime value corresponds to worse case average drift found during AEC-Q100 qualification.

ACS37612LLUATR-010B5 PERFORMANCE CHARACTERISTICS: Valid over full range of T_A and $V_{CC} = 5\text{ V}$, unless otherwise specified

Characteristic	Symbol	Test Conditions	Min.	Typ. [1]	Max.	Unit
NOMINAL PERFORMANCE						
Differential Magnetic Range	B_{DIFF}		-200	-	200	G
Sensitivity	Sens	$V_{CC}(\min) \leq V_{CC} \leq V_{CC}(\max)$	-	10	-	mV/G
ACCURACY PERFORMANCE						
Noise	V_N	$T_A = 25^\circ\text{C}$, $C_L = 1\text{ nF}$, $BW = 120\text{ kHz}$	-	9	-	mV _{RMS}
		$T_A = 25^\circ\text{C}$, $C_L = 1\text{ nF}$, $BW = 240\text{ kHz}$	-	12.5	-	mV _{RMS}
Sensitivity Error	E_{SENS}	$T_A = 25^\circ\text{C}$	-2	± 1	2	%
Sensitivity Drift Over Temperature	ΔSens_{TC}	$T_A = 25^\circ\text{C}$ to 150°C	-2	± 1	2	%
		$T_A = -40^\circ\text{C}$ to 25°C	-2	± 1	2	%
Factory Quiescent Voltage Output Error	V_{OE}	$T_A = 25^\circ\text{C}$	-5	± 3	5	mV
Quiescent Voltage Output Temperature Error	$V_{OUT(Q)TC}$	$T_A = 25^\circ\text{C}$ to 150°C	-10	± 3	10	mV
		$T_A = -40^\circ\text{C}$ to 25°C	-10	± 3	10	mV
QVO Ratiometry Error	$V_{RatERRQVO}$	$V_{CC} = \pm 5\%$ variation of nominal supply voltage	-7.5	± 2.5	7.5	mV
Sens Ratiometry Error	$Rat_{ERRSens}$	$V_{CC} = \pm 5\%$ variation of nominal supply voltage	-1.25	± 0.5	1.25	%
LIFETIME DRIFT CHARACTERISTICS [2]						
QVO Lifetime Drift	$V_{QVOLife}$	$T_A = 25^\circ\text{C}$	-	1.4	-	mV
Sens Lifetime Drift	$Sens_{ERRLife}$	$T_A = 25^\circ\text{C}$	-	0.6	-	%
QVO TC Lifetime Drift	$V_{QVOTCLife}$	$T_A = 25^\circ\text{C}$ to 150°C	-	1.5	-	mV
Sens TC Lifetime Drift	$Sens_{TCLife}$	$T_A = 25^\circ\text{C}$ to 150°C	-	0.6	-	%

[1] All typical values are ± 3 sigma.

[2] Typical lifetime value corresponds to worse case average drift found during AEC-Q100 qualification.

ACS37612LLUATR-010B-C Variant

Characteristic	Symbol	Test Conditions	Min.	Typ.	Max.	Unit
CLAMP PERFORMANCE						
Clamps Enabled	-			Enabled		-

ACS37612LLUATR-015B5 PERFORMANCE CHARACTERISTICS: Valid over full range of T_A and $V_{CC} = 5\text{ V}$, unless otherwise specified

Characteristic	Symbol	Test Conditions	Min.	Typ. [1]	Max.	Unit
NOMINAL PERFORMANCE						
Differential Magnetic Range	B_{DIFF}		-130	-	130	G
Sensitivity	Sens	$V_{CC(min)} \leq V_{CC} \leq V_{CC(max)}$	-	15	-	mV/G
ACCURACY PERFORMANCE						
Noise	V_N	$T_A = 25^\circ\text{C}$, $C_L = 1\text{ nF}$, $BW = 120\text{ kHz}$	-	13	-	mV _{RMS}
		$T_A = 25^\circ\text{C}$, $C_L = 1\text{ nF}$, $BW = 240\text{ kHz}$	-	19	-	mV _{RMS}
Sensitivity Error	E_{SENS}	$T_A = 25^\circ\text{C}$	-2	± 1	2	%
Sensitivity Drift Over Temperature	ΔSens_{TC}	$T_A = 25^\circ\text{C}$ to 150°C	-2	± 1	2	%
		$T_A = -40^\circ\text{C}$ to 25°C	-2	± 1	2	%
Factory Quiescent Voltage Output Error	V_{OE}	$T_A = 25^\circ\text{C}$	-10	± 6	10	mV
Quiescent Voltage Output Temperature Error	$V_{OUT(Q)TC}$	$T_A = 25^\circ\text{C}$ to 150°C	-10	± 6	10	mV
		$T_A = -40^\circ\text{C}$ to 25°C	-10	± 6	10	mV
QVO Ratiometry Error	$V_{RatERRQVO}$	$V_{CC} = \pm 5\%$ variation of nominal supply voltage	-7.5	± 2.5	7.5	mV
Sens Ratiometry Error	$Rat_{ERRSens}$	$V_{CC} = \pm 5\%$ variation of nominal supply voltage	-1.25	± 0.5	1.25	%
LIFETIME DRIFT CHARACTERISTICS [2]						
QVO Lifetime Drift	$V_{QVOLife}$	$T_A = 25^\circ\text{C}$	-	1.4	-	mV
Sens Lifetime Drift	$Sens_{ERRLife}$	$T_A = 25^\circ\text{C}$	-	0.6	-	%
QVO TC Lifetime Drift	$V_{QVOTCLife}$	$T_A = 25^\circ\text{C}$ to 150°C	-	1.5	-	mV
Sens TC Lifetime Drift	$Sens_{TCLife}$	$T_A = 25^\circ\text{C}$ to 150°C	-	0.6	-	%

[1] All typical values are ± 3 sigma.

[2] Typical lifetime value corresponds to worse case average drift found during AEC-Q100 qualification.

ACS37612LLUATR-015U5 PERFORMANCE CHARACTERISTICS: Valid over full range of T_A and $V_{CC} = 5\text{ V}$, unless otherwise specified

Characteristic	Symbol	Test Conditions	Min.	Typ. [1]	Max.	Unit
NOMINAL PERFORMANCE						
Differential Magnetic Range	B_{DIFF}		0	–	265	G
Sensitivity	Sens	$V_{CC}(\min) \leq V_{CC} \leq V_{CC}(\max)$	–	15	–	mV/G
ACCURACY PERFORMANCE						
Noise	V_N	$T_A = 25^\circ\text{C}$, $C_L = 1\text{ nF}$, $BW = 120\text{ kHz}$	–	13	–	mV _{RMS}
		$T_A = 25^\circ\text{C}$, $C_L = 1\text{ nF}$, $BW = 240\text{ kHz}$	–	19	–	mV _{RMS}
Sensitivity Error	E_{SENS}	$T_A = 25^\circ\text{C}$	–2	± 1	2	%
Sensitivity Drift Over Temperature	ΔSens_{TC}	$T_A = 25^\circ\text{C}$ to 150°C	–2	± 1	2	%
		$T_A = -40^\circ\text{C}$ to 25°C	–2	± 1	2	%
Factory Quiescent Voltage Output Error	V_{OE}	$T_A = 25^\circ\text{C}$	–10	± 6	10	mV
Quiescent Voltage Output Temperature Error	$V_{OUT(Q)TC}$	$T_A = 25^\circ\text{C}$ to 150°C	–10	± 6	10	mV
		$T_A = -40^\circ\text{C}$ to 25°C	–10	± 6	10	mV
QVO Ratiometry Error	$V_{RatERRQVO}$	$V_{CC} = \pm 5\%$ variation of nominal supply voltage	–7.5	± 2.5	7.5	mV
Sens Ratiometry Error	$RatERRSens$	$V_{CC} = \pm 5\%$ variation of nominal supply voltage	–1.25	± 0.5	1.25	%
LIFETIME DRIFT CHARACTERISTICS [2]						
QVO Lifetime Drift	$V_{QVOLife}$	$T_A = 25^\circ\text{C}$	–	1.4	–	mV
Sens Lifetime Drift	$SensERRLife$	$T_A = 25^\circ\text{C}$	–	0.6	–	%
QVO TC Lifetime Drift	$V_{QVOTCLife}$	$T_A = 25^\circ\text{C}$ to 150°C	–	1.5	–	mV
Sens TC Lifetime Drift	$SensTCLife$	$T_A = 25^\circ\text{C}$ to 150°C	–	0.6	–	%

[1] All typical values are ± 3 sigma.

[2] Typical lifetime value corresponds to worse case average drift found during AEC-Q100 qualification.

FUNCTIONAL DESCRIPTION

Principle of Operation

When AC or DC current flows through a PCB copper trace or a busbar, as shown in Figure 7, the ACS37612 device will sense the field difference between its two Hall elements H1 and H2, represented by field components B- and B+. The device output will be proportional to the differential field sensed, which is

proportional to the applied current. The relationship between applied current and generated field is described as:

$$B_{diff} = CF \times I,$$

where B_{diff} is the differential field (H1-H2), CF is the differential coupling factor, and I is the current through the busbar/PCB trace.

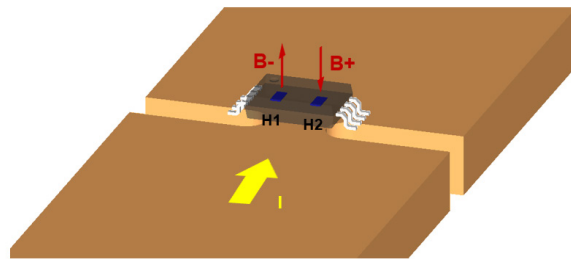

Figure 7: Current Sensing Principle

Device Output Polarity

Current flowing through the PCB/busbar in the direction of pin 1 to pin 4, as shown in Figure 8, increases the output voltage from its quiescent value toward the supply voltage rail (from 2.5 V to 4.5 V typical on bidirectional version, and 0.5 V to 4.5 V typical on unidirectional version).

The amount the output voltage increases is proportional to the magnitude of the applied current. Conversely, current flowing in the opposite direction decreases the output voltage from its quiescent value.

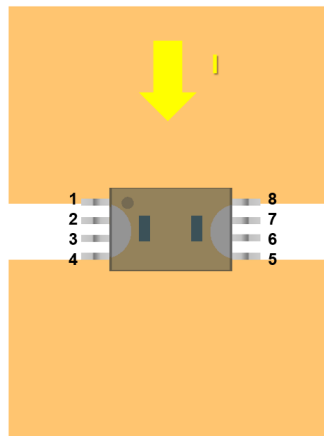

Figure 8: Sensor output polarity with respect to current flow and sensor pins

DYNAMIC RESPONSE CHARACTERISTICS

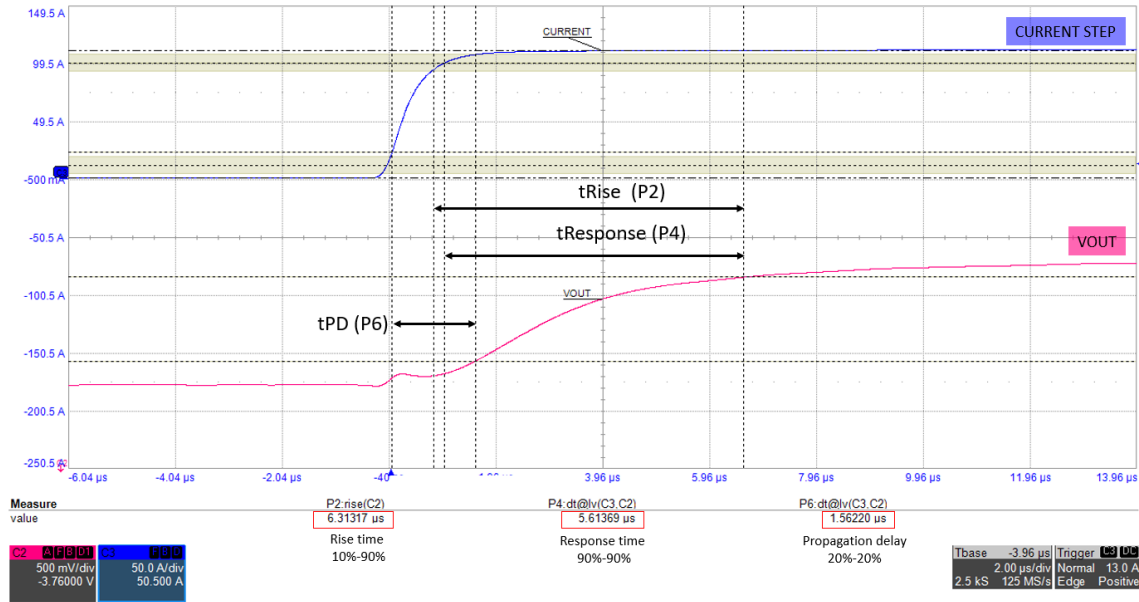

Figure 9: Response time, rise time, and propagation delay on 3.5 mm Reference PCB.
 $T_A = 25^\circ\text{C}$, $C_{\text{BYPASS}} = 100 \text{ nF}$, $C_L = 1 \text{ nF}$, $\text{BW} = 120 \text{ kHz}$

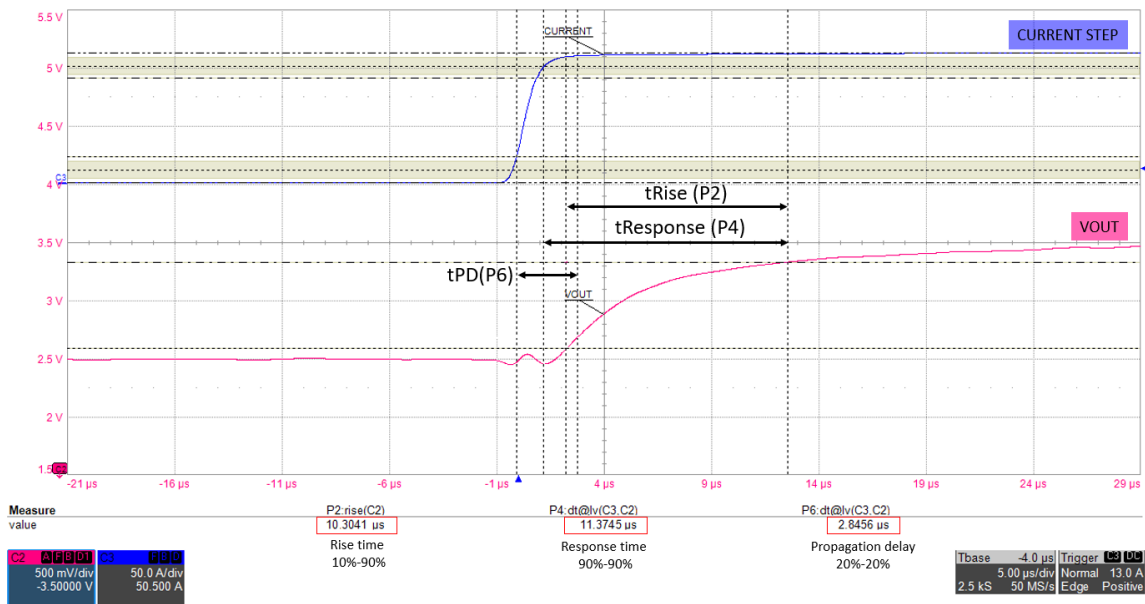

Figure 10: Response time, rise time, and propagation delay on Reference Busbar.
 $T_A = 25^\circ\text{C}$, $C_{\text{BYPASS}} = 100 \text{ nF}$, $C_L = 1 \text{ nF}$, $\text{BW} = 120 \text{ kHz}$

Power-On Reset (POR) and Undervoltage Lockout (UVLO) Operation – Nominal Supply Voltage = 5 V

The descriptions in this section assume: temperature = 25°C, no output load (R_L , C_L), and no significant magnetic field is present.

- Power-Up.** At power-up, as V_{CC} ramps up, the output is in a high-impedance state. When V_{CC} crosses V_{PORH} (location [1] in Figure 11 and [1'] in Figure 12), the POR Release counter starts counting for t_{PORR} . At this point, if V_{CC} exceeds V_{UVLOD} [2'], the output will go to $V_{CC}/2$ after t_{UVLOD} [3']. If V_{CC} does not exceed V_{UVLOD} [2], the output will stay in the high-impedance state until V_{CC} reaches V_{UVLOD} [3] and then will go to $V_{CC}/2$ after t_{UVLOD} [4].
- V_{CC} drops below $V_{CC}(min) = 4.5 V$.** If V_{CC} drops below V_{UVLOE} [4', 5], the UVLO Enable Counter starts counting. If V_{CC} is still below V_{UVLOE} when counter reaches t_{UVLOE} , the UVLO function will be enabled and the output will be pulled near GND [6]. If V_{CC} exceeds V_{UVLOE} before the UVLO Enable Counter reaches t_{UVLOE} [5'], the output will continue to be $V_{CC}/2$.
- Coming out of UVLO.** While UVLO is enabled [6], if V_{CC} exceeds V_{UVLOD} [7], UVLO will be disabled after t_{UVLOD} , and the output will be $V_{CC}/2$ [8].
- Power-Down.** As V_{CC} ramps down below V_{UVLOE} [6', 9], the UVLO Enable Counter will start counting. If V_{CC} is higher than V_{PORL} when the counter reaches t_{UVLOE} , the UVLO function will be enabled and the output will be pulled near GND [10]. The output will enter a high-impedance state as V_{CC} goes below V_{PORL} [11]. If V_{CC} falls below V_{PORL} before the UVLO Enable Counter reaches t_{UVLOE} , the output will transition directly into a high-impedance state [7'].

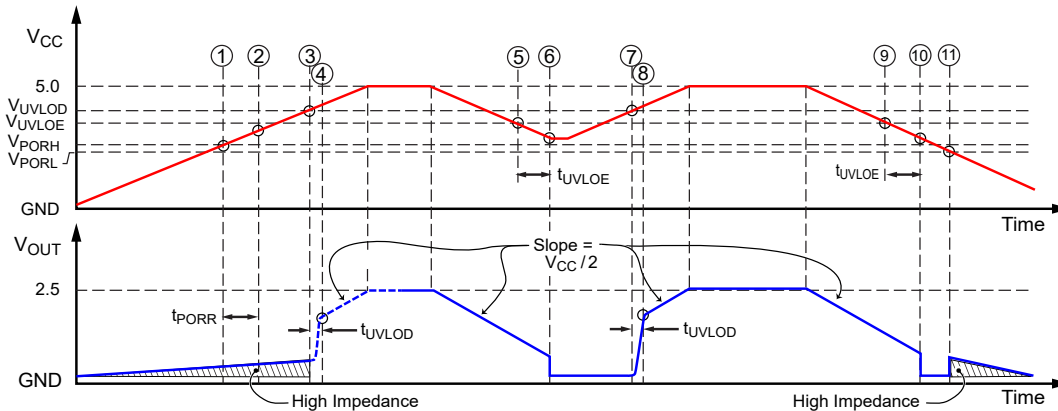

Figure 11: POR and UVLO Operation – Slow Rise Time Case – 5 V Mode

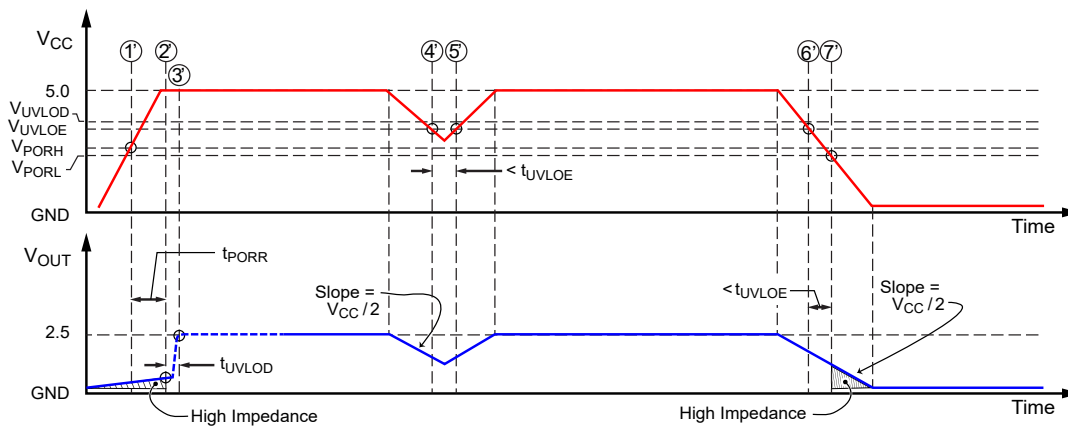

Figure 12: POR and UVLO Operation – Fast Rise Time Case – 5 V Mode

Power-On Reset (POR); Undervoltage Lockout (UVLO) Disabled – Nominal Supply Voltage = 3.3 V

Power-Up

At power-up, as V_{CC} ramps up, the output is in a high-impedance state. When V_{CC} crosses V_{PORH} (location [1] in Figure 13 and [1'] in Figure 14), the POR Release counter starts counting for t_{PORR} [2], [2'] and the output will go to $V_{CC}/2$ after t_{PORD} [3], [3']. The temperature compensation engine will then adjust the device Sensitivity and QVO after time t_{TC} [4], [4'].

V_{CC} drops below $V_{CC}(\min) = 3 V$

If V_{CC} drops below V_{PORH} [5'] but remains higher than V_{PORL} [6'], the output will continue to be $V_{CC}/2$.

Power-Down

As V_{CC} ramps down below V_{PORL} [5],[7'], the output will enter a high-impedance state.

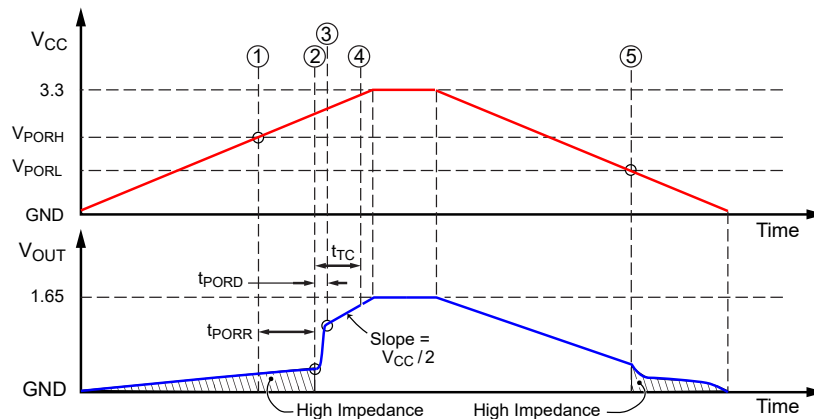

Figure 13: POR and UVLO Operation – Slow Rise Time Case – 3.3 V Mode

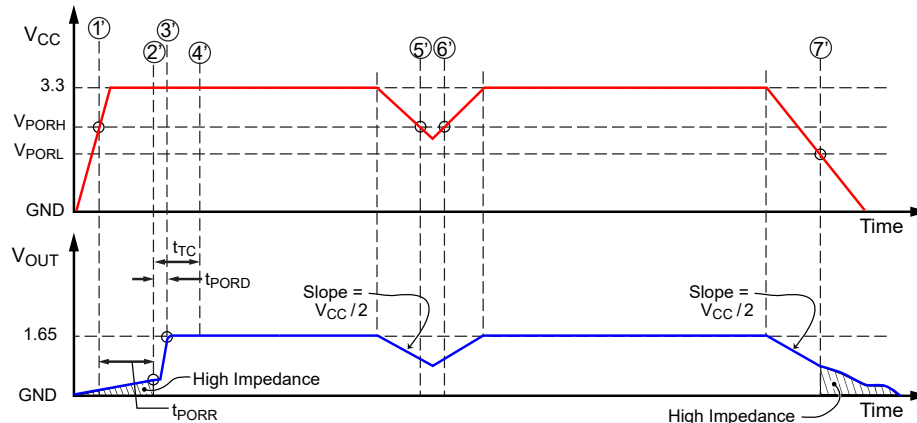

Figure 14: POR and UVLO Operation – Fast Rise Time Case – 3.3 V Mode

DEFINITIONS OF ACCURACY CHARACTERISTICS

SENSITIVITY (Sens)

The amount of the output voltage increase is proportional to the magnitude of the magnetic field applied. This proportionality is specified as the magnetic sensitivity, Sens (mV/G), of the device, and it is defined as:

$$Sens = \frac{V_{OUT(B1)} - V_{OUT(B2)}}{B1 - B2}$$

where B1 and B2 are two different magnetic field levels.

SENSITIVITY DRIFT THROUGH TEMPERATURE RANGE ($\Delta Sens_{TC}$)

Second-order sensitivity temperature coefficient effects cause the magnetic sensitivity, Sens, to drift from its expected value over the operating ambient temperature range (T_A). The Sensitivity Drift Through Temperature Range ($\Delta Sens_{TC}$) is defined as:

$$\Delta Sens_{TC} = \frac{Sens_{TA} - Sens_{EXPECTED(TA)}}{Sens_{EXPECTED(TA)}} \times 100 (\%)$$

NONLINEARITY (E_{LIN})

The nonlinearity is a measure of how linear the output of the sensor IC is over the full current measurement range. The nonlinearity is calculated as:

$$E_{LIN} = \left\{ 1 - \left[\frac{Sens_{BPRMax}}{Sens_{BPRHalf}} \right] \right\} \times 100 (\%)$$

where $Sens_{BPRMax}$ is the sensitivity measured at the full range output level and $Sens_{BPRHalf}$ is the sensitivity measured at half of the full range output level.

RATIOMETRY

The device features a ratiometric output. This means that the quiescent voltage output, $V_{OUT(Q)}$, and the magnetic sensitivity, Sens, are proportional to the supply voltage, V_{CC} . The ratiometric change in the quiescent voltage output is defined as:

$$V_{RatERRQVO} = \left[\left(V_{OUTQ(5V)} \times \frac{V_{CC}}{5V} \right) - V_{OUTQ(VCC)} \right] \times 1000 (\text{mV})$$

and the ratiometric change (%) in sensitivity is defined as:

$$Rat_{ERRSens} = \left[1 - \frac{\left(\frac{Sens_{(VCC)}}{Sens_{(5V)}} \right)}{\left(\frac{V_{CC}}{5V} \right)} \right] \times 100 (\%)$$

and the ratiometric change (%) in clamp voltage is defined as:

$$Rat_{ERRCLP} = \left[1 - \frac{\left(\frac{V_{CLP(VCC)}}{V_{CLP(5V)}} \right)}{\left(\frac{V_{CC}}{5V} \right)} \right] \times 100 (\%)$$

QUIESCENT OUTPUT VOLTAGE ($V_{OUT(Q)}$)

The output of the sensor when no magnetic field is detected. For a unipolar supply voltage, it nominally remains at $0.5 \times V_{CC}$ for a bidirectional device and $0.1 \times V_{CC}$ for a unidirectional device. For example, in the case of a bidirectional output device, $V_{CC} = 5\text{ V}$ translates into $V_{OUT(Q)} = 2.5\text{ V}$. Variation in $V_{OUT(Q)}$ can be attributed to the resolution of the Allegro linear IC quiescent voltage trim and thermal drift.

VOLTAGE OFFSET ERROR (V_{OE})

The deviation of the device output from its ideal quiescent value of $0.5 \times V_{CC}$ (bidirectional) or $0.1 \times V_{CC}$ (unidirectional) due to nonmagnetic causes.

POWER-ON RESET VOLTAGE (V_{POR})

On power-up, to initialize to a known state and avoid current spikes, the device is held in Reset state. The Reset signal is

disabled when V_{CC} reaches V_{PORH} and time t_{PORR} has elapsed, allowing the output voltage to go from a high-impedance state into normal operation. During power-down, the Reset signal is enabled when V_{CC} reaches V_{PORL} , causing the output voltage to go into a high-impedance state. (Note that a detailed description of POR can be found in the Functional Description section).

POWER-ON RESET RELEASE TIME (t_{PORR})

When V_{CC} rises to V_{PORH} , the Power-On Reset Counter starts. The device output voltage will transition from a high-impedance state to normal operation only when the Power-On Reset Counter has reached t_{PORR} and V_{CC} has been maintained above V_{PORH} .

OUTPUT SATURATION VOLTAGE (V_{SAT})

When output voltage clamps are disabled, the output voltage can swing to a maximum of $V_{SAT(HIGH)}$ and to a minimum of $V_{SAT(LOW)}$.

DEFINITIONS OF DYNAMIC RESPONSE CHARACTERISTICS

POWER-ON TIME (t_{PO})

When the supply is ramped to its operating voltage, the device requires a finite time to power its internal components before responding to an input magnetic field. Power-On Time, t_{PO} , is defined as the time it takes for the output voltage to settle within $\pm 10\%$ of its steady-state value under an applied magnetic field, after the power supply has reached its minimum specified operating voltage, $V_{CC(min)}$, as shown in Figure 15.

RISE TIME (t_r)

The time interval between a) when the sensor reaches 10% of its full-scale value, and b) when it reaches 90% of its full-scale value, as shown in Figure 16.

PROPAGATION DELAY (t_{PD})

The time interval between a) when the sensed current reaches 20% of its full-scale value, and b) when the sensor output reaches 20% of its full-scale value, as shown in Figure 16.

RESPONSE TIME ($t_{RESPONSE}$)

The time interval between a) when the sensed current reaches 90% of its final value, and b) when the sensor output reaches 90% of its full-scale value, as shown in Figure 17.

Delay to Clamp (t_{CLP})

A large magnetic input step may cause the clamp to overshoot its steady-state value. The Delay to Clamp, t_{CLP} , is defined as: the time it takes for the output voltage to settle within $\pm 1\%$ of Clamp Voltage Dynamic Range, after initially passing through its steady-state voltage, as shown in Figure 18.

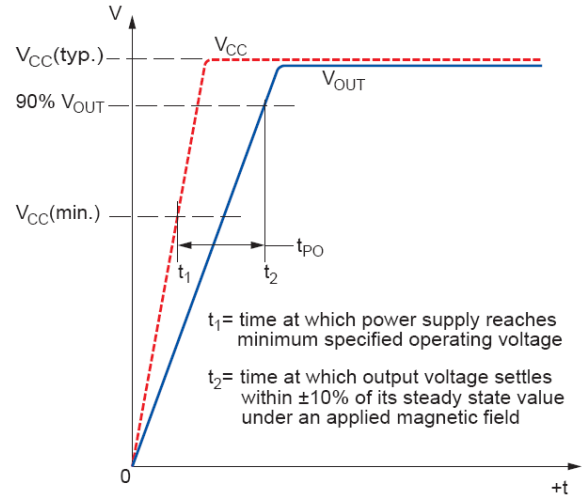

Figure 15: Power-On Time (t_{PO})

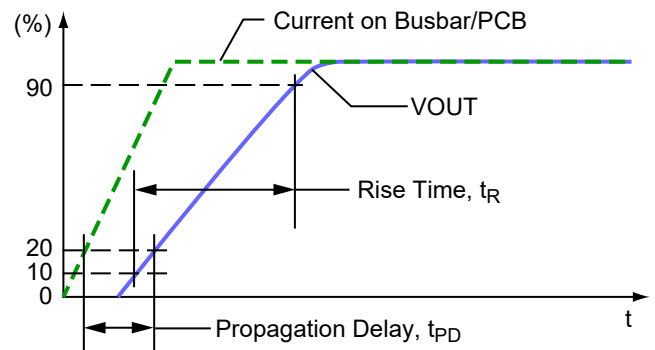

Figure 16: Propagation Delay (t_{PD}) and Rise Time (t_r)

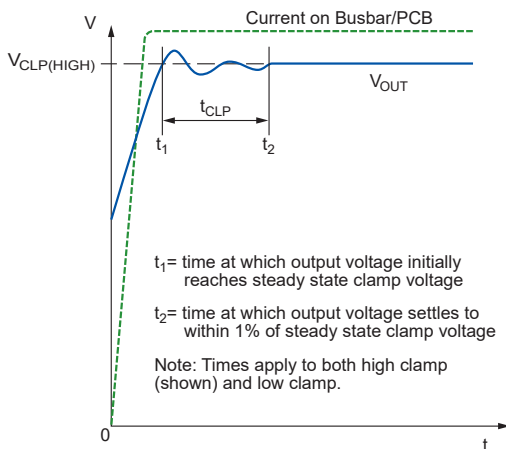

Figure 18: Delay to Clamp

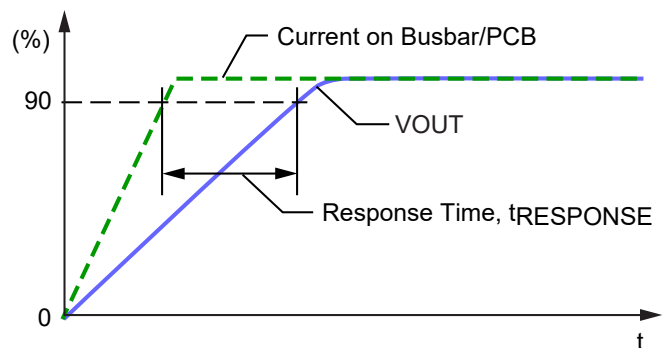

Figure 17: Response Time ($t_{RESPONSE}$)

APPLICATION INFORMATION

Typical Application – Busbar Sensing

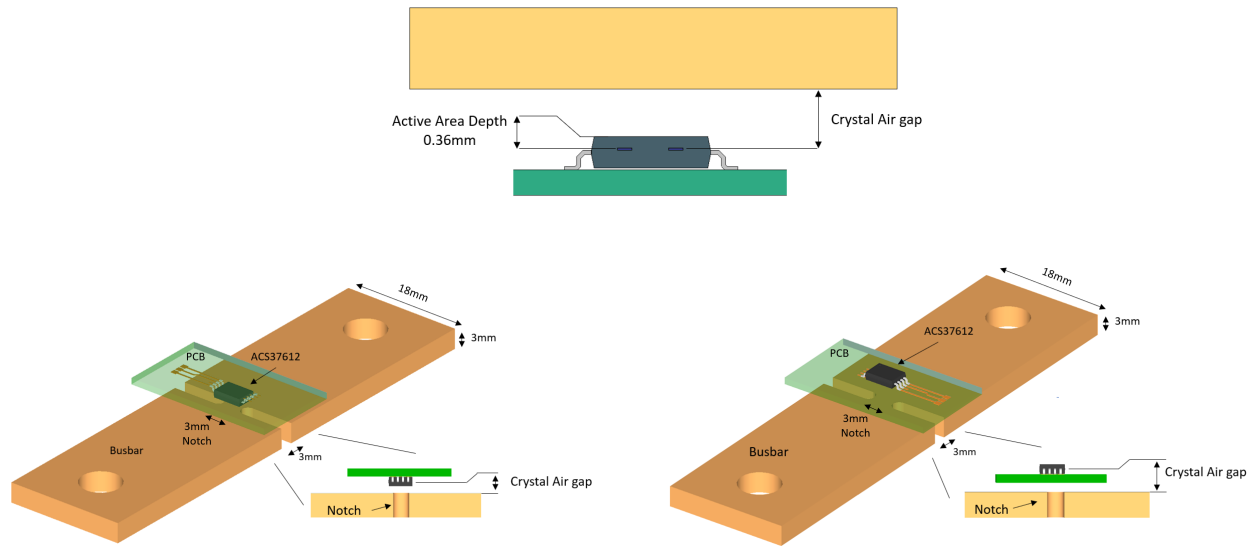

Figure 19: Busbar current sensing application – reference busbar design

The ACS37612 is ideal for busbar current sensing applications.

For a given current flowing through the busbar, the magnitude of the differential magnetic field sensed by the IC will depend on the air gap between the busbar and the IC.

Adding a notch (width reduction) to the busbar at the location where the sensor is placed significantly increases the magnitude of the magnetic field, improving SNR. Keeping the notch length short (2 to 3 mm) results in virtually no increase in the resistance of the busbar or degradation of its thermal performance.

Different busbar and notch dimensions can be used to optimize system performance and respond to application constraints.

Figure 19 and Table 1 highlight the dimensions of an Allegro

evaluation board designed to measure ± 1000 A.

Note: Comparing the busbar described in Figure 19 to a bare busbar (without notch), the busbar with the 3 mm notch increased the overall impedance by less than $1 \mu\Omega$, increasing busbar temperature by only few degrees during testing.

Skin Effect Consideration

Skin effect in the conductor tends to reduce the magnitude of the differential magnetic field measured by the IC at high frequencies (coupling factor) and therefore will influence the bandwidth of the system and response time to transient current.

Skin effect will depend on busbar dimensions, sensor mounting orientation, and distance between the busbar and the IC.

Table 1: Current range based on reference busbar design:

Busbar Application	Maximum Current (A)	Coupling Factor at 2.5 mm Crystal Air Gap ^[1]	Differential Field (G)	IC Sensitivity (mV/G)
18 × 3 mm Busbar + 3 mm Notch	± 1000	0.19	± 190	10

^[1] Crystal air gap is defined as the distance from the busbar surface to the device sensing elements (considering active area depth).

Multiple Busbar Design Options

The ACS37612 offers many different mounting possibilities, addressing different needs (bandwidth, mounting tolerances, and crosstalk). The figures below show different mounting options.

Refer to Allegro's website (<https://www.allegromicro.com>) for application notes explaining the tradeoffs between different topologies.

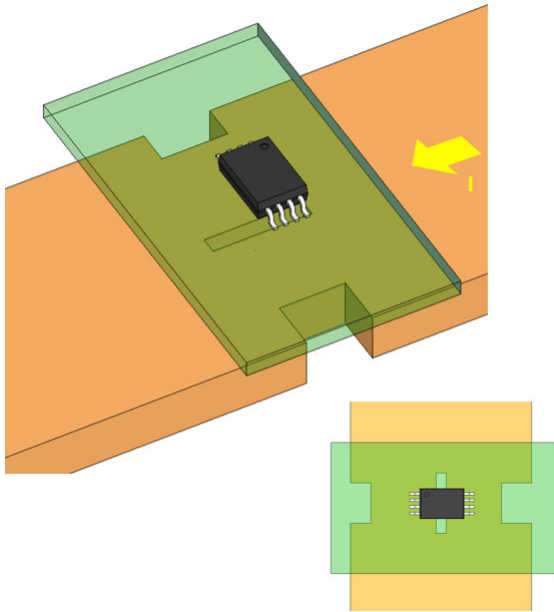

Figure 20: Rift Busbar Design

High mounting tolerances, medium coupling factor, high skin effect.
For DC to low frequency AC applications <1 kHz.

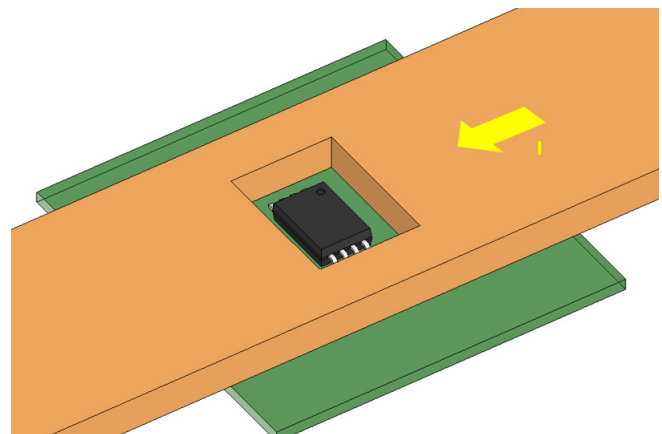

Figure 21: Slit Busbar Design

High mounting tolerances, medium coupling factor, medium skin effect.
For DC to medium frequency AC applications <100 kHz.

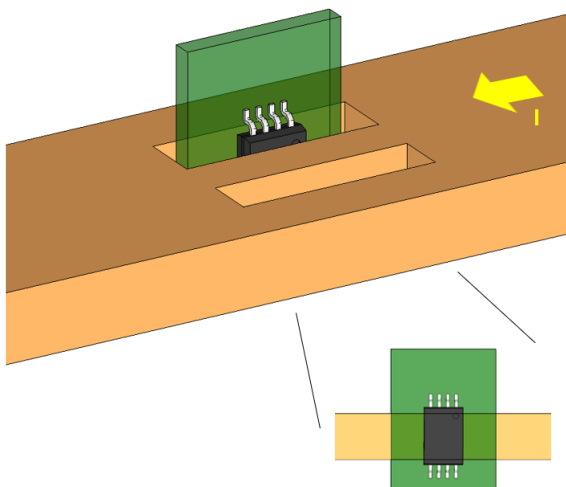

Figure 22: Dual Vertical Slit Busbar Design

High mounting tolerances, high coupling factor, low skin effect.
For DC to high frequency AC applications >100 kHz.

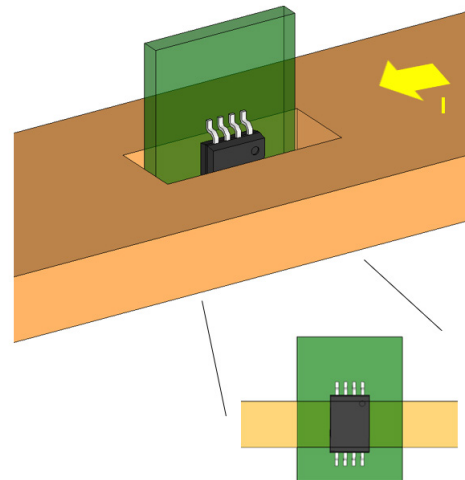

Figure 23: Vertical Slit Busbar Design

High mounting tolerances, high coupling factor, low skin effect.
For DC to high frequency AC applications >100 kHz.

Typical Application – PCB Sensing

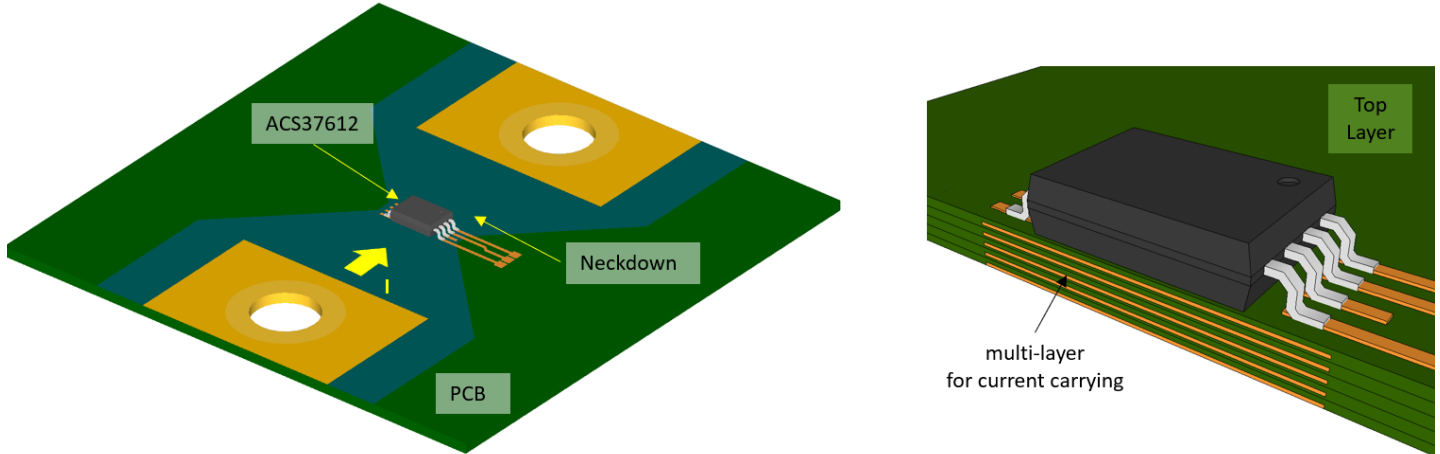

Figure 24: PCB Current sensing application – 6-Layer reference PCB example

The ACS37612 can also be used in PCB applications where the current flows directly in the PCB instead of on a busbar.

Multiple copper layers can be used to carry the current. Reducing the width of the copper traces under the sensor (neckdown) increases the magnitude of the differential magnetic field measured by the IC.

Different copper layer dimensions and stackups can be used to optimize performance and are specific to the constraints of the application. For example, in higher voltage applications, the top layer would only be used for signal routing in order to use the PCB replaced by dielectric layer for isolation.

Figure 24 and Table 2 highlight the dimensions of three Allegro evaluation boards designed to measure a wide current range.

Care must be taken when routing the device signal to prevent

noise coupling to the supply or output lines.

The power plane in the neckdown area should also be avoided to prevent disturbing the magnetic field measured.

Skin Effect Consideration

Skin effect in the PCB current-carrying traces will tend to reduce the differential magnetic field measured by the IC at high frequencies (coupling factor) and therefore will influence the bandwidth of the system and response time to transient current.

Skin effect is generally limited on PCB application due to thin copper layer thickness, but the effect will depend on PCB copper trace dimensions, number of layers, and layer thickness.

Skin effect will depend on PCB copper trace dimensions, number of layers, and layer thickness.

Table 2: Current range based on reference PCB design:

PCB Application [1]	Corresponding Full-Scale Current (A) [2]	Coupling Factor (G/A)	Differential Field (G)	IC Sensitivity (mV/G)
5 Layers – Reference Design 3.5 mm – 015B5	±180	0.74	±133	15
5 Layers – Reference Design 3.5 mm – 010B5	±270	0.74	±200	10
5 Layers – Reference Design 4.5 mm – 015B5	±233	0.57	±133	15
5 Layers – Reference Design 4.5 mm – 010B5	±350	0.57	±200	10
5 Layers – Reference Design 7 mm – 015B5	±500	0.265	±133	15
5 Layers – Reference Design 7 mm – 010B5	±750	0.265	±200	10

[1] Maximum continuous current without proper cooling on these PCB designs should not exceed 200 A.

[2] Full-scale current is required to cover the full-scale output range (bidirectional = ±2 V).

PACKAGE OUTLINE DRAWING For Reference Only – Not for Tooling Use

(Reference MO-153 AA)
NOT TO SCALE
Dimensions in millimeters
Dimensions exclusive of mold flash, gate burrs, and dambar protrusions
Exact case and lead configuration at supplier discretion within limits shown

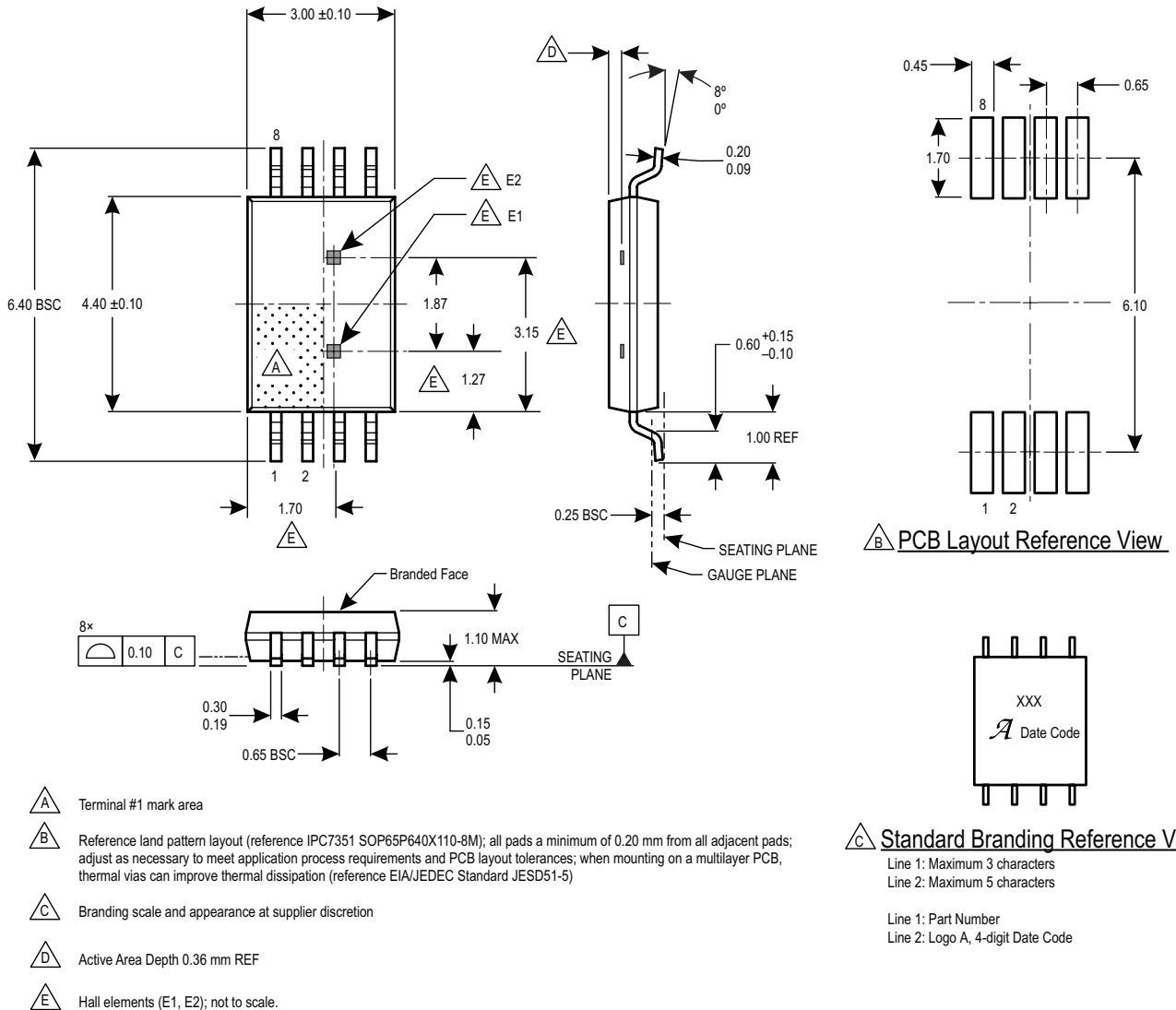

Figure 25: Package LU, 8-Pin TSSOP Package

Revision History

Number	Date	Description
–	March 9, 2020	Initial release
1	January 5, 2021	Updated Description (page 1), Selection Guide (page 2); added Power Derating plot (page 3); updated Internal Bandwidth values, characteristic table headings, symbols, test conditions, and other editorial changes (pages 5-10); removed Hall Spacing characteristic (page 5); updated Figure 6, Device Output Polarity description and figure description (page 11); updated characteristic performance plot figure descriptions (page 12); updated section title (page 13); Multiple Busbar Design Options figure descriptions (page 19); Typical Application - PCB Sensing description (page 20)
2	December 10, 2021	Added 010B5-C part variant (page 2, 9); removed lead-free symbol (page 2); updated Figure 4 (page 4); updated Figure 6 (page 5); minor editorial updates

Copyright 2021, Allegro MicroSystems.

Allegro MicroSystems reserves the right to make, from time to time, such departures from the detail specifications as may be required to permit improvements in the performance, reliability, or manufacturability of its products. Before placing an order, the user is cautioned to verify that the information being relied upon is current.

Allegro's products are not to be used in any devices or systems, including but not limited to life support devices or systems, in which a failure of Allegro's product can reasonably be expected to cause bodily harm.

The information included herein is believed to be accurate and reliable. However, Allegro MicroSystems assumes no responsibility for its use; nor for any infringement of patents or other rights of third parties which may result from its use.



Copies of this document are considered uncontrolled documents.

For the latest version of this document, visit our website:

www.allegromicro.com

Looking for pricing, stock, or lifecycle information?

Click below to explore more details on WIN SOURCE:

-  [View ACS37612LLUALU-010B3 on WIN SOURCE](#)
-  [Allegro MicroSystems, LLC Information](#)

Optimize Your Supply Chain with WIN SOURCE Solutions

-  Global Sourcing Solution
-  Obsolete Management
-  Cost Control Management
-  Shortage Management
-  Alternative Solution
-  Excess Inventory Management