



**THE DATASHEET OF  
150EBU02**



# Ultrafast Soft Recovery Diode, 150 A FRED Pt®



PowerTab®



## FEATURES

- Ultrafast recovery time
- 175 °C max. operating junction temperature
- Screw mounting only
- Designed and qualified according to JEDEC-JESD47
- Compliant to RoHS Directive 2002/95/EC
- PowerTab® package

 RoHS  
COMPLIANT

## BENEFITS

- Reduced RFI and EMI
- Higher frequency operation
- Reduced snubbing
- Reduced parts count

## DESCRIPTION/APPLICATIONS

These diodes are optimized to reduce losses and EMI/RFI in high frequency power conditioning systems. The softness of the recovery eliminates the need for a snubber in most applications. These devices are ideally suited for HF welding, power converters and other applications where switching losses are not significant portion of the total losses.

PRODUCT SUMMARY	
Package	PowerTab®
$I_{F(AV)}$	150 A
$V_R$	200 V
$V_F$ at $I_F$	1.13 V
$t_{rr}$ (typ.)	See recovery table
$T_J$ max.	175 °C
Diode variation	Single die

ABSOLUTE MAXIMUM RATINGS				
PARAMETER	SYMBOL	TEST CONDITIONS	MAX.	UNITS
Cathode to anode voltage	$V_R$		200	V
Continuous forward current	$I_{F(AV)}$	$T_C = 116\text{ °C}$	150	A
Single pulse forward current	$I_{FSM}$	$T_C = 25\text{ °C}$	1600	
Maximum repetitive forward current	$I_{FRM}$	Square wave, 20 kHz	380	
Operating junction and storage temperatures	$T_J, T_{Stg}$		- 55 to 175	°C

ELECTRICAL SPECIFICATIONS ( $T_J = 25\text{ °C}$ unless otherwise specified)						
PARAMETER	SYMBOL	TEST CONDITIONS	MIN.	TYP.	MAX.	UNITS
Breakdown voltage, blocking voltage	$V_{BR}, V_R$	$I_R = 100\text{ }\mu\text{A}$	200	-	-	V
Forward voltage	$V_F$	$I_F = 150\text{ A}$	-	0.99	1.13	
		$I_F = 150\text{ A}, T_J = 175\text{ °C}$	-	0.79	0.90	
Reverse leakage current	$I_R$	$V_R = V_R$ rated	-	-	50	$\mu\text{A}$
		$T_J = 150\text{ °C}, V_R = V_R$ rated	-	-	2	mA
Junction capacitance	$C_T$	$V_R = 200\text{ V}$	-	180	-	pF
Series inductance	$L_S$	Measured lead to lead 5 mm from package body	-	3.5	-	nH



<b>DYNAMIC RECOVERY CHARACTERISTICS</b> ( $T_J = 25\text{ }^\circ\text{C}$ unless otherwise specified)							
PARAMETER	SYMBOL	TEST CONDITIONS	MIN.	TYP.	MAX.	UNITS	
Reverse recovery time	$t_{rr}$	$I_F = 1.0\text{ A}$ , $dI_F/dt = 200\text{ A}/\mu\text{s}$ , $V_R = 30\text{ V}$	-	-	45	ns	
		$T_J = 25\text{ }^\circ\text{C}$	-	34	-		
		$T_J = 125\text{ }^\circ\text{C}$	-	58	-		
Peak recovery current	$I_{RRM}$	$I_F = 150\text{ A}$ $V_R = 160\text{ V}$ $dI_F/dt = 200\text{ A}/\mu\text{s}$	$T_J = 25\text{ }^\circ\text{C}$	-	4.5	-	A
			$T_J = 125\text{ }^\circ\text{C}$	-	9.0	-	
Reverse recovery charge	$Q_{rr}$		$T_J = 25\text{ }^\circ\text{C}$	-	87	-	nC
			$T_J = 125\text{ }^\circ\text{C}$	-	300	-	

<b>THERMAL - MECHANICAL SPECIFICATIONS</b>						
PARAMETER	SYMBOL	TEST CONDITIONS	MIN.	TYP.	MAX.	UNITS
Thermal resistance, junction to case	$R_{thJC}$		-	-	0.35	K/W
Thermal resistance, case to heatsink	$R_{thCS}$	Mounting surface, flat, smooth and greased	-	0.2	-	
Weight			-	-	5.02	g
			-	0.18	-	oz.
Mounting torque			1.2 (10)	-	2.4 (20)	N · m (lb · in)
Marking device		Case style PowerTab®	150EBU02			

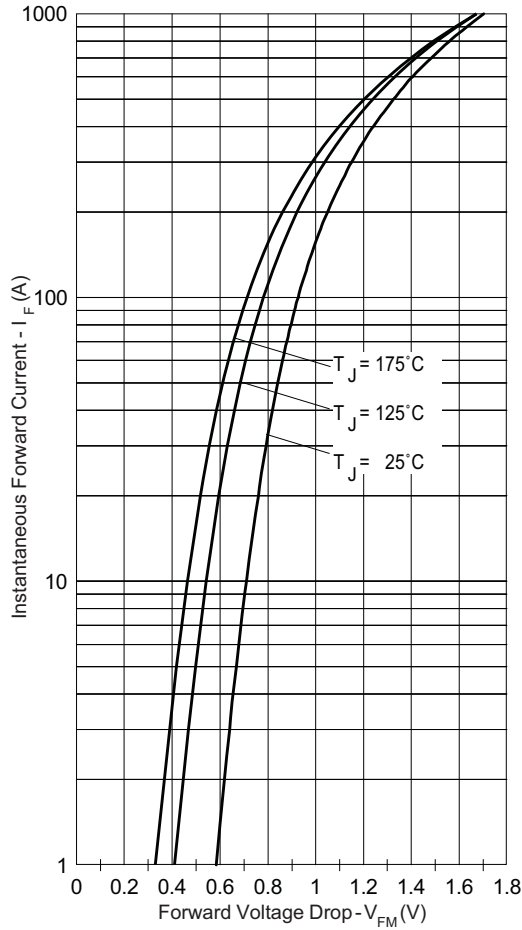

Fig. 1 - Maximum Forward Voltage Drop Characteristics

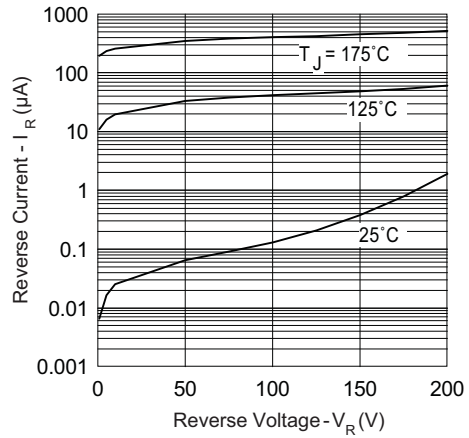

Fig. 2 - Typical Values of Reverse Current vs. Reverse Voltage

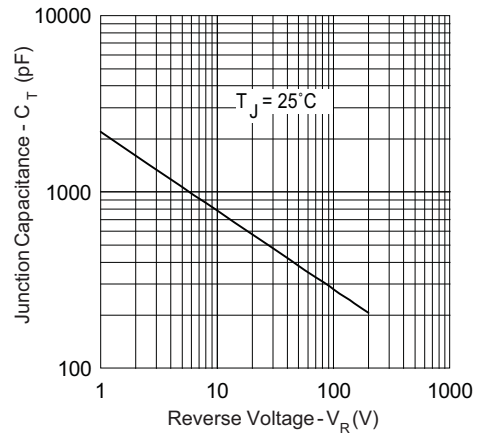

Fig. 3 - Typical Junction Capacitance vs. Reverse Voltage

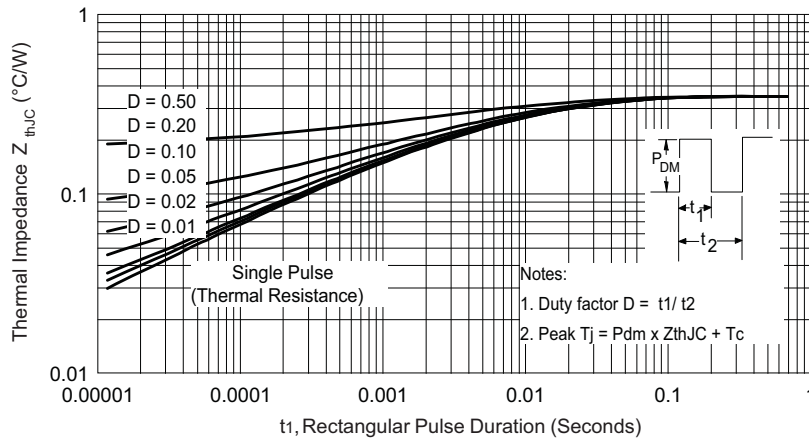

Fig. 4 - Maximum Thermal Impedance  $Z_{thJC}$  Characteristics

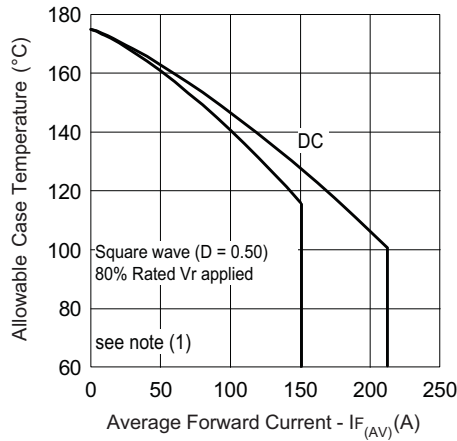

Fig. 5 - Maximum Allowable Case Temperature vs. Average Forward Current

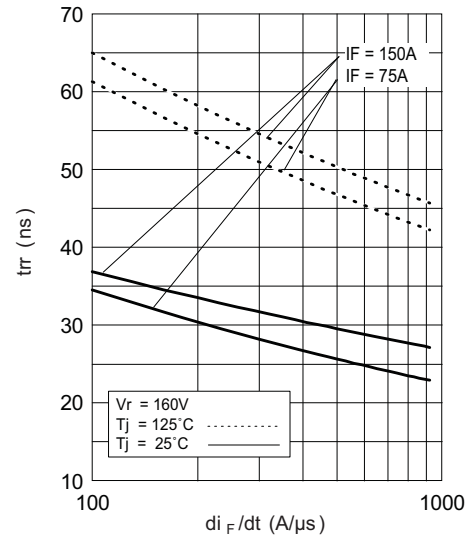

Fig. 7 - Typical Reverse Recovery Time vs.  $dI_F/dt$

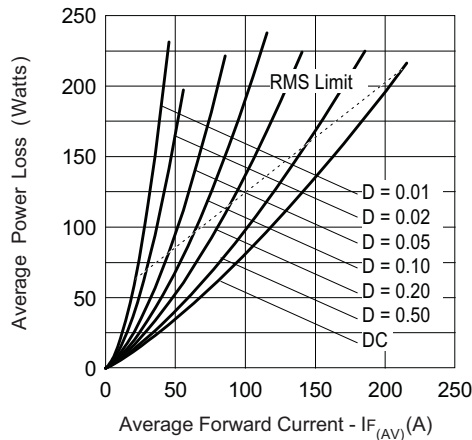

Fig. 6 - Forward Power Loss Characteristics

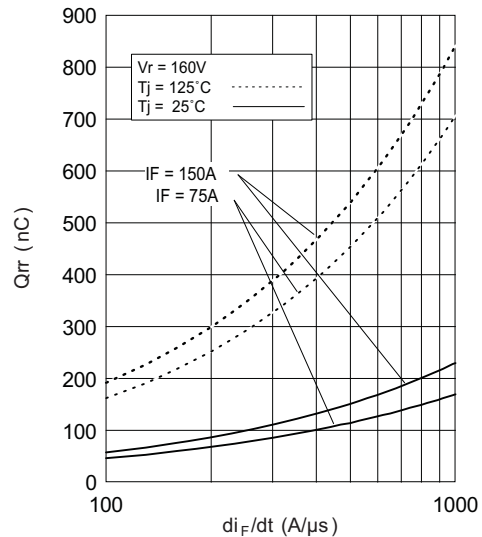

Fig. 8 - Typical Stored Charge vs.  $dI_F/dt$

**Note**

- (1) Formula used:  $T_C = T_J - (P_d + P_{d_{REV}}) \times R_{thJC}$ ;  
 $P_d$  = Forward power loss =  $I_{F(AV)} \times V_{FM}$  at  $(I_{F(AV)}/D)$  (see fig. 6);  
 $P_{d_{REV}}$  = Inverse power loss =  $V_{R1} \times I_R (1 - D)$ ;  $I_R$  at  $V_{R1} = 80\%$  rated  $V_R$

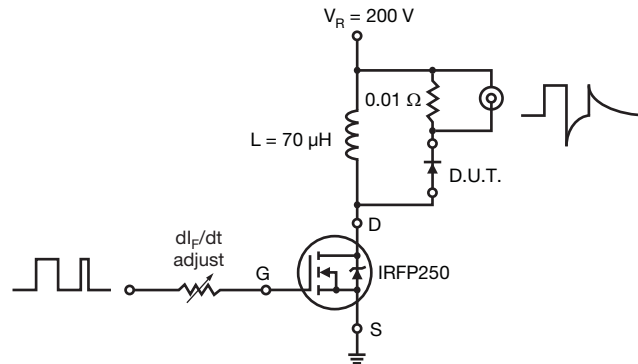
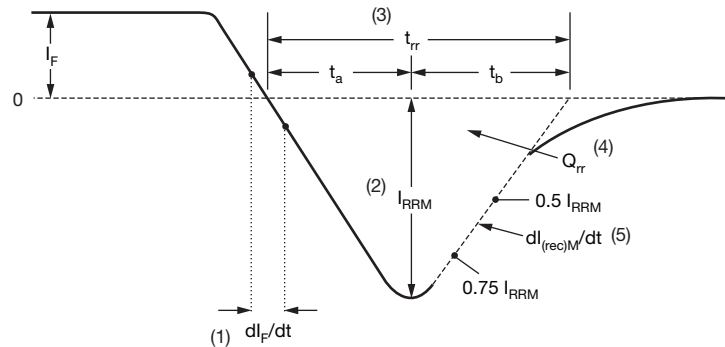

Fig. 9 - Reverse Recovery Parameter Test Circuit



- (1)  $di_F/dt$  - rate of change of current through zero crossing
- (2)  $I_{RRM}$  - peak reverse recovery current
- (3)  $t_{rr}$  - reverse recovery time measured from zero crossing point of negative going  $I_F$  to point where a line passing through  $0.75 I_{RRM}$  and  $0.50 I_{RRM}$  extrapolated to zero current.
- (4)  $Q_{rr}$  - area under curve defined by  $t_{rr}$  and  $I_{RRM}$
- (5)  $dl_{(rec)M}/dt$  - peak rate of change of current during  $t_b$  portion of  $t_{rr}$

$$Q_{rr} = \frac{t_{rr} \times I_{RRM}}{2}$$

Fig. 10 - Reverse Recovery Waveform and Definitions



ORDERING INFORMATION TABLE

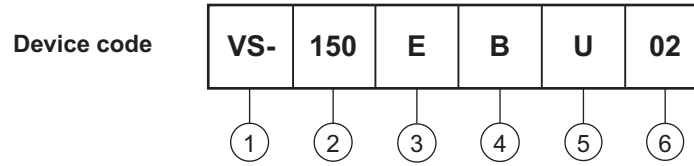

- 1** - Vishay Semiconductors product
- 2** - Current rating (150 = 150 A)
- 3** - Single diode
- 4** - PowerTab® (ultrafast/hyperfast only)
- 5** - Ultrafast recovery
- 6** - Voltage rating (02 = 200 V)

LINKS TO RELATED DOCUMENTS	
Dimensions	<a href="http://www.vishay.com/doc?95240">www.vishay.com/doc?95240</a>
Part marking information	<a href="http://www.vishay.com/doc?95370">www.vishay.com/doc?95370</a>
Application note	<a href="http://www.vishay.com/doc?95179">www.vishay.com/doc?95179</a>



## PowerTab®

**DIMENSIONS** in millimeters (inches)

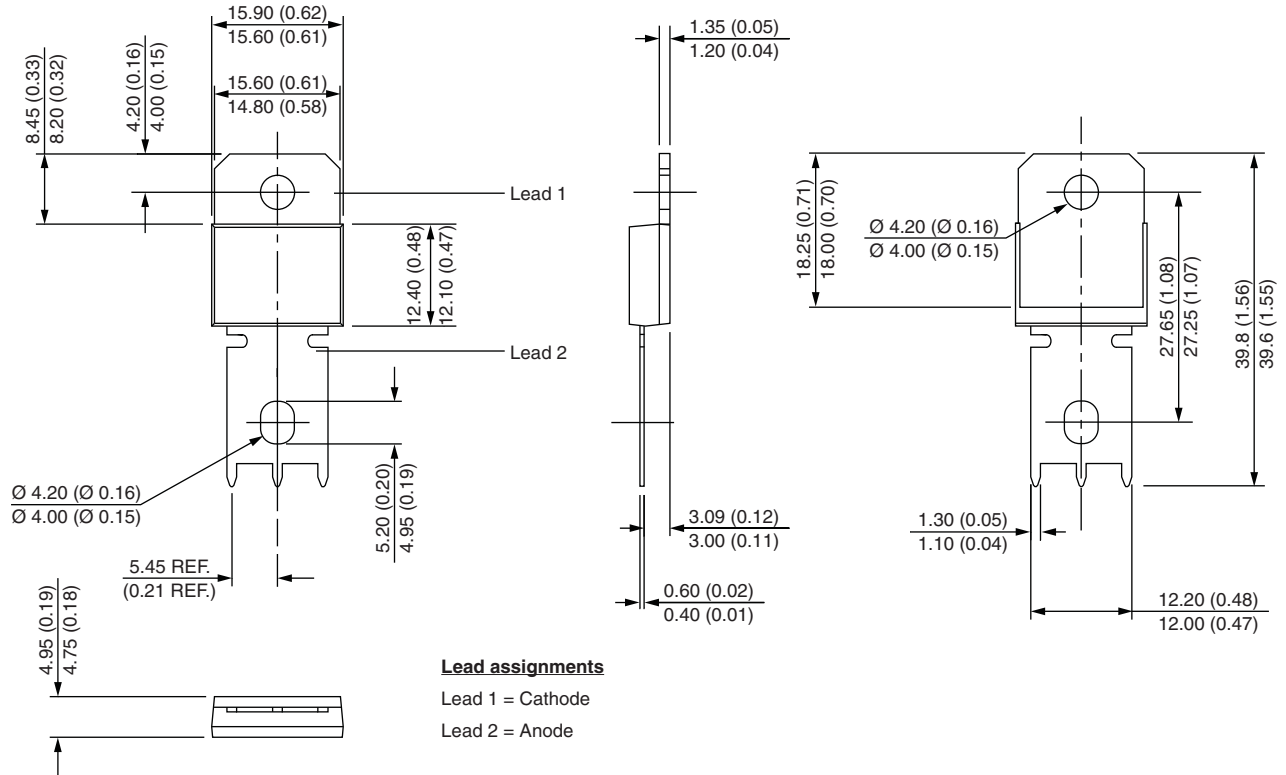



## Disclaimer

ALL PRODUCT, PRODUCT SPECIFICATIONS AND DATA ARE SUBJECT TO CHANGE WITHOUT NOTICE TO IMPROVE RELIABILITY, FUNCTION OR DESIGN OR OTHERWISE.

Vishay Intertechnology, Inc., its affiliates, agents, and employees, and all persons acting on its or their behalf (collectively, "Vishay"), disclaim any and all liability for any errors, inaccuracies or incompleteness contained in any datasheet or in any other disclosure relating to any product.

Vishay makes no warranty, representation or guarantee regarding the suitability of the products for any particular purpose or the continuing production of any product. To the maximum extent permitted by applicable law, Vishay disclaims (i) any and all liability arising out of the application or use of any product, (ii) any and all liability, including without limitation special, consequential or incidental damages, and (iii) any and all implied warranties, including warranties of fitness for particular purpose, non-infringement and merchantability.

Statements regarding the suitability of products for certain types of applications are based on Vishay's knowledge of typical requirements that are often placed on Vishay products in generic applications. Such statements are not binding statements about the suitability of products for a particular application. It is the customer's responsibility to validate that a particular product with the properties described in the product specification is suitable for use in a particular application. Parameters provided in datasheets and/or specifications may vary in different applications and performance may vary over time. All operating parameters, including typical parameters, must be validated for each customer application by the customer's technical experts. Product specifications do not expand or otherwise modify Vishay's terms and conditions of purchase, including but not limited to the warranty expressed therein.

Except as expressly indicated in writing, Vishay products are not designed for use in medical, life-saving, or life-sustaining applications or for any other application in which the failure of the Vishay product could result in personal injury or death. Customers using or selling Vishay products not expressly indicated for use in such applications do so at their own risk. Please contact authorized Vishay personnel to obtain written terms and conditions regarding products designed for such applications.

No license, express or implied, by estoppel or otherwise, to any intellectual property rights is granted by this document or by any conduct of Vishay. Product names and markings noted herein may be trademarks of their respective owners.

## Material Category Policy

**Vishay Intertechnology, Inc. hereby certifies that all its products that are identified as RoHS-Compliant fulfill the definitions and restrictions defined under Directive 2011/65/EU of The European Parliament and of the Council of June 8, 2011 on the restriction of the use of certain hazardous substances in electrical and electronic equipment (EEE) - recast, unless otherwise specified as non-compliant.**

**Please note that some Vishay documentation may still make reference to RoHS Directive 2002/95/EC. We confirm that all the products identified as being compliant to Directive 2002/95/EC conform to Directive 2011/65/EU.**

**Vishay Intertechnology, Inc. hereby certifies that all its products that are identified as Halogen-Free follow Halogen-Free requirements as per JEDEC JS709A standards. Please note that some Vishay documentation may still make reference to the IEC 61249-2-21 definition. We confirm that all the products identified as being compliant to IEC 61249-2-21 conform to JEDEC JS709A standards.**

## Looking for pricing, stock, or lifecycle information?

Click below to explore more details on WIN SOURCE:

 [View 150EBU02 on WIN SOURCE](#)

 [Vishay Information](#)

## Optimize Your Supply Chain with WIN SOURCE Solutions

-  Global Sourcing Solution
-  Obsolete Management
-  Cost Control Management
-  Shortage Management
-  Alternative Solution
-  Excess Inventory Management