



**THE DATASHEET OF
RN73R1JTTD1112D25**





PASSIVE COMPONENTS

Selection Guide



Surface Mount Resistors & Arrays

Flat chip resistors and arrays include general purpose, high precision, pulse and surge, high voltage, high heat, anti sulfuration and zero ohm types for applications ranging from general purpose to ultra precision.



Thick Film

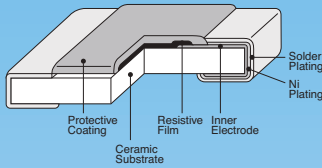

- Sizes available: 01005 0603 1210 0201 0805 2010 0402 1206 2512
- RuO₂ thick film

General Purpose - RK73B

- Tolerance: $\pm 2\%$ and $\pm 5\%$
- Resistance range: $1\Omega \sim 22M\Omega$
- RK73BW3A2 (2512 = 2W)

Precision - RK73H

- Tolerance: $\pm 0.5\%$ and $\pm 1\%$
- Resistance range: $1\Omega \sim 10M\Omega$
- RK73HW3A2 (2512 = 2W)

High Precision - RK73G

- T.C.R.: ± 50 ppm/K
- Resistance range: $10\Omega \sim 1M\Omega$
- Tolerance: $\pm 0.25\%$, $\pm 0.5\%$ and $\pm 1\%$

NEW Ultra High Precision and High Reliability - RS73 Series

- $\pm 0.2\%$ ~ Long term stability
- $\pm 0.1\%$, $\pm 0.25\%$, $\pm 0.5\%$ or $\pm 1\%$,
- T.C.R.: ± 25 or ± 50 ppm/K

NEW High Temperature - HRK73 Series

- Operating temperature up to $+200^\circ\text{C}$
- Au or Sn plated products
- Sizes available: 0603, 0805, 1206

Zero Ohm - RK73Z

- Maximum resistance of $50m\Omega$
- Maximum continuous current @ 70°C : $0.5A \sim 2.0A$

Anti Sulfur

NEW RT-Series

- Excellent anti-sulfuration characteristics due to using high-sulfuration-proof inner top electrode material
- Intended for use under harsh environment
- Available for several standard product series:

RK73B_RT	CN_RT	SG73_RT
RK73H_RT	CN_KRT	SG73S_RT
RK73Z_RT	CNZ_RT	SG73P_RT
RK73G_RT	HV73_RT	WK73S_RT
SR73_RT	HV73V_RT	WK73R_RT
RS73_RT		

Specialty

Surge Current - SG73

- 10x pulse power capability
- Tolerance: $\pm 10\%$, $\pm 20\%$
- Sizes available: 0603 ~ 2512

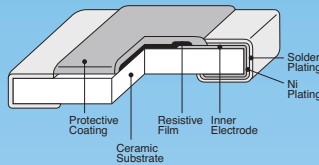

Pulse SG73P and Surge SG73S

- Resistance range: $1\Omega \sim 10M\Omega$
- Tolerance: $\pm 0.5\%$, $\pm 1\%$, $\pm 2\%$, $\pm 5\%$
- Sizes available: 0402 ~ 1210
- Increased power rating** (e.g.: 0603 = 0.33W, 1210 = 1W)

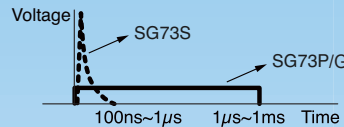

NEW Pulse Power and Ultra High Precision SG73G Series

- Tolerance: $\pm 0.25\%$ or $\pm 0.5\%$
- T.C.R.: ± 50 ppm/K

Wide Terminal - WK73R

- Robust thermal cycle characteristic
- Power rating: $0.33W \sim 3W$
- Tolerance: $\pm 0.5\%$, $\pm 1\%$ or $\pm 5\%$
- Sizes available: 0204 ~ 1225

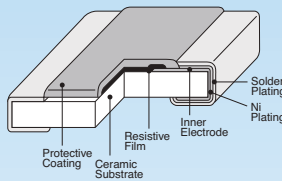

NEW Wide Terminal Pulse Power - WG73 Series

- Higher pulse withstanding
- Tolerance: $\pm 10\%$ or $\pm 20\%$
- T.C.R.: ± 100 ppm/K
- Sizes available: 0612, 1020, 1225

High Voltage - HV73

- 2.5x to 10x rated working voltage of standard thick film
- Chip size 2512 with 3kV rated voltage
- Sizes available: 0603, 0805, 1206, 2010, 2512 350V, 400V, 800V, 2kV, 3kV
- Resistance range: $10k\Omega \sim 100M\Omega$
- Tolerance: $\pm 0.5\%$, $\pm 1\%$, $\pm 2\%$, $\pm 5\%$

NEW High Voltage - HV73V-automotive

- Chip sizes: 0603, 0805, 1206
- AEC-Q200 qualified

Thin Film

Ultra Precision - RN73

- Nickel chromium thin film resistor element
- Resistance range: $10\Omega \sim 1M\Omega$
- Tolerance: $\pm 0.05\% \sim \pm 1\%$
- T.C.R.: ± 5 , ± 10 , ± 25 , ± 50 or ± 100 ppm/K

NEW Ultra Precision, High Reliability RN73R Series

- Improved Metal Film Resistor
- Rated ambient temperature: $+85^\circ\text{C}$
- Resistance range: $10\Omega \sim 1.5M\Omega$
- Tolerance: $\pm 0.05\% \sim \pm 1\%$
- T.C.R.: ± 5 to ± 100 ppm/K
- Sizes available: 0402 to 1206

Ultra Precision, Highest Reliability - Automotive - RN73H Series

- Improved moisture resistance
- Additional inorganic passivation
- Rated ambient temperature: $+85^\circ\text{C}$
- Resistance range: $10\Omega \sim 1.5M\Omega$
- Tolerance: $\pm 0.05\% \sim \pm 1\%$
- T.C.R.: ± 5 to ± 100 ppm/K
- Sizes available: 0402 to 1210

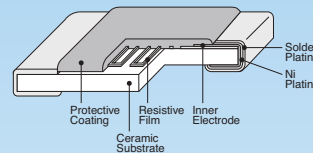

MELF

Carbon Film/Metal Film/Zero Ohm

- RD41 Carbon film series
- RN41 Metal film series
- CC Zero ohm series

Checker Chips

Checker Chips - RCU/RCT/RCS/RCW

- Surface mountable test terminals
- Automatic mounting possible
- Standard chip sizes: 0603, 0805, 1206
- Maximum resistance: $50m\Omega$
- Rated current: 2A

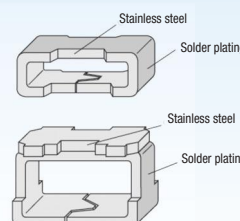

Resistor Arrays

Isolated Resistors

Convex, Square Corners - CN_K

- Resistance range: $10\Omega \sim 1M\Omega$
- Tolerance: $\pm 1\% \sim \pm 5\%$
- Sizes available: 0402, 0603, 1206 x2, x4, x8 elements

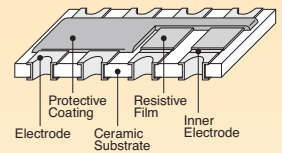

Concave, Square Corners - CN

- Resistance range: $10\Omega \sim 1M\Omega$
- Tolerance: $\pm 1\% \sim \pm 5\%$
- Sizes available: 0402, 0603, 0805, 1206 x2, x4, x8 elements

Convex, Scalloped Corners - CN_A

- Resistance range: $1\Omega \sim 1M\Omega$
- Tolerance: $\pm 1\%$ and $\pm 5\%$
- Sizes available: 0603, 1206 x2, x4 elements

Zero Ohm Jumper - CNZ

Convex or Concave

- Current rating @ 70°C (per element): $0.5A$ and $1.0A$
- Sizes available: 0402, 0603, 0805, 1206 x2, x4, x8 elements

Anti-Sulfur - RT-Series

- Excellent anti-sulfuration characteristics
- High heat and weather resistance
- Series available: CN_RT CN_KRT CNZ_RT

Bussed Resistors

Convex or Concave - GND

- Reverse common electrode and side electrode type circuits available
- Resistance range: $22\Omega \sim 100K\Omega$
- Tolerance: $\pm 5\%$
- Sizes available: 1206, 1608 and 2512

Convex Staggered Terminations - CNB

- Resistance range: $1K\Omega \sim 470K\Omega$
- Tolerance: $\pm 5\%$
- 4 or 8 elements included in one array in 2 sizes

Current Sense Resistors

Four basic types of current sensing resistors are available in low-ohm, high precision, 4-terminal Kelvin, high power, low profile, high frequency, high heat, and power shunt chips for a wide range of detecting applications and power applications.



Thick Film

Low-Ohm - SR73 Series

- Resistance range: 24mΩ ~ 10Ω
- Tolerance: ±0.5% ~ ±5%
- Sizes available: 0201 ~ 2512 (2W)
- Best T.C.R.: ±100 ppm/K

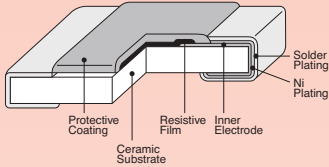

Ultra-Low Ohm - UR73(D) Series

- Face-up and face-down types available
- Resistance range: 10mΩ ~ 100mΩ
- Tolerance: ±1%
- Improved T.C.R.: ±100 ~ ±300 ppm/K
- Sizes available: 0402 ~ 2512

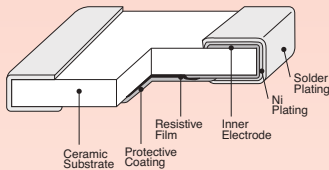

Ultra-Low Ohm - UR73V(D) Series

- Automotive, AEC-Q200 qualified
- Size: 0805 (0.5W), 1206 (0.75W)
- Resistance range: 10mΩ ~ 100mΩ
- T.C.R.: ±75 ~ +250ppm/K
- Operating temp. up to +155°C

Wide Terminal - WK73S

- Robust thermal cycle characteristic
- Power rating: 0.75W ~ 3W
- Resistance range: 10mΩ ~ 9.1Ω
- Tolerance: ±0.5%, ±1% or ±5%
- T.C.R.: ±100, ±200, ±300 or ±800ppm/K
- Sizes available: 0508 ~ 1225

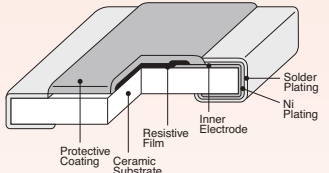

Wide Terminal - WU73 Series

- Improved T.C.R. type
- Resistance range: 10mΩ ~ 100mΩ
- T.C.R.: ±100, ±150ppm/K
- Size 1206, 1W, **1.5W**

NEW Anti Sulfur - RT Series

- Excellent anti sulfuration characteristics due to using high-sulfuration-proof inner top electrode material
- Available for several standard product-series:

SR73_RT WK73S_RT

Molded

Robust Leadframe

SL(N)/TSL Series

- Molded with flame retardant resin (UL94 V-0)
- Enhanced thermal shock capability
- Operating temperature: up to +180°C
- Increased power rating e.g.:
 - SLW07(2010) = 1W
 - SLW1(2512) = 1.5W
 - SLN5(4527) = 7W
- Resistance range: 3mΩ ~ 22MΩ
- Tolerance: ±0.5%, ±1%, ±2%, ±5%
- T.C.R.: ±50 ~ ±200 ppm/K

Jumper - SLZ1 Series

- Maximum resistance of 0.5mΩ
- Current rating: 44A

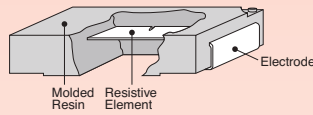

4 Terminal - CSR Series

- Suitable for Kelvin applications
- Molded with flame retardant resin
- Power rating: 1W & 2W
- Resistance range: 5mΩ ~ 50mΩ
- Tolerance: ±0.5 or ±1%
- T.C.R.: ±50 ppm/K

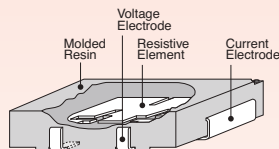

Ceramic Case

Ceramic Case - BLR Series

- Flame retardant resistor in ceramic case
- Resistance range: 8mΩ ~ 50mΩ
- Tolerance: ±5%, ±10%
- Power rating: 1W, 2W or 15W

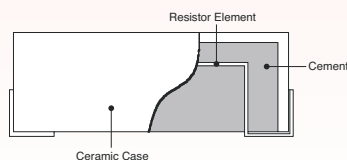

Metal Plate

TLR Series

- Resistance range: 0.5mΩ ~ 20mΩ
- Tolerance: ±1%, ±2% or 5%
- Ultra low T.C.R.: ±50, ±75, ±100 ppm/K
- 0402, 0805, 1206, 2010, 2512 chip size
- Ultra low height: 0.25 ~ 0.6mm
- Increased power rating e.g.:
 - TLR2BP (1206) = 1.5W
 - TLR2HW (2010) = 2W
 - TLR3AP (2512) = 3W

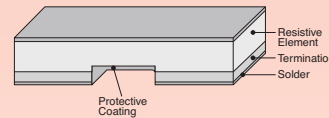

Jumper - TLRZ Series

- Sizes 0402, 0603, 0805, 1206
- Maximum resistance of 0.2mΩ (0.5mΩ)
- Current rating: 10A ~ **50A**

TLR H Series

- Resistance range: 6mΩ - 270mΩ
- Tolerance: ±1%
- T.C.R.: ±50, ±75 ppm/K
- Low height: 0.25, 0.5 mm
- 0805, 2512 chip size
- Power rating 0.25W ~ 5W

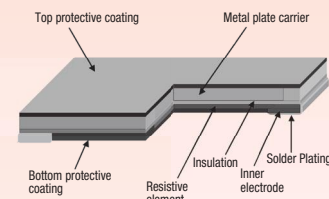

LR72 Series

- Power rating: 0.25W, 0.5W, 1W
- Resistance range: 2mΩ ~ 8mΩ
- Tolerance: ±5%
- T.C.R.: ±100, ±350 ppm/K
- Custom configurations available

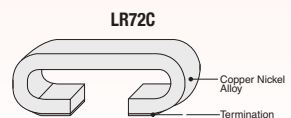
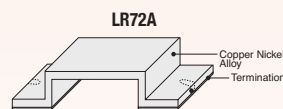

Power Shunt

NEW Large Current - HS Series

- Power rating: 18W, 36W
- Resistance values: 100μΩ, 200μΩ
- T.C.R.: 50±25 ppm/K
- Size: 40 x 15 x 2(1) mm
- Current detection by voltage pins



NEW High Power - PSJ2/PSL2 Series

- Power rating: 5W ~ 12W
- Resistance range: 200μΩ ~ **4mΩ**
- Tolerance: ±1%
- T.C.R.: **±50** ~ ±200ppm/K
- Sizes: 2512, 3920



High Power - PSG4/PSF4 Series

- 4 Terminal configuration
- Power rating: 3W, 5W, 8W, 10W
- Resistance values: 0.5mΩ, 1mΩ
- Tolerance: ±1%
- T.C.R.: ±50ppm/K
- Sizes: 1216, 2725



High Power - PSB Series

- Power rating: 6W, 7W
- Resistance range: 0.2mΩ, 0.75mΩ, 1mΩ
- Tolerance: ±1%
- T.C.R.: ±75 ppm/K, ±100 ppm/K
- Special electrode shape ensures excellent temperature cycling characteristics

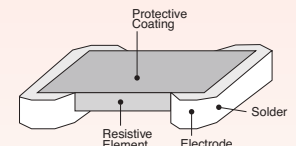

High Power - PSI/PSE Series

- Power rating: 3W, 5W
- Resistance values: 0.5mΩ ~ 4mΩ
- Tolerance: ±1%, ±5%
- T.C.R.: ±50ppm/K, ±150ppm/K
- Sizes: 2525, 3920
- Smooth current flow, suitable for large current detection

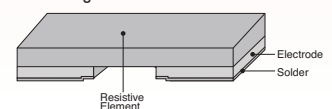

Thermal Sensors and Circuit Protection

In addition to our flat chip resistors we offer a complete line of circuit protection products including thermistors, platinum sensors, chip and ceramic case fuses and metal oxide varistors.



Thermal Sensors

Thin Film Linear PTC - LT73(V)/LP73

- LT73 available in 25 specifiable temperature characteristics
- **LT73V:** 0805 & 1206 for automotive
- **LP73:** narrow T.C.R. tolerance $\pm 5\%$
- Resistance range: $51\Omega \sim 51k\Omega$
- Resistance tolerance: $\pm 1\%$, $\pm 2\%$, $\pm 5\%$
- T.C.R.: $\pm 150 \sim \pm 5000$ ppm/K
- T.C.R. Tolerance: ± 150 ppm/K $\sim \pm 15\%$
- Sizes available: 0603, 0805 & 1206

Positive Temperature Characteristics

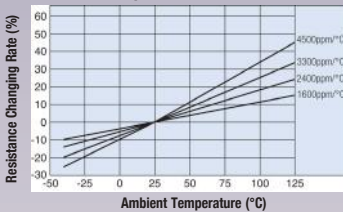

Thick Film Linear PTC - LA73

- Available in 13 specifiable temperature characteristics
- T.C.R. Tolerance: ± 200 ppm/K or $\pm 10\%$
- Resistance range: $22\Omega \sim 10k\Omega$, $\pm 5\%$
- Sizes available: 0603, 0805 & 1206

NTC Thermistor- NT73

- Resistance range: $1k\Omega \sim 150k\Omega$
- Resistance tolerance: $\pm 5\% \sim \pm 15\%$
- B constant: $3200K \sim 4100K$
- B constant tolerance: $\pm 3\% \sim \pm 10\%$
- Sizes available: 0603, 0805, 1206

Negative Temperature Characteristics

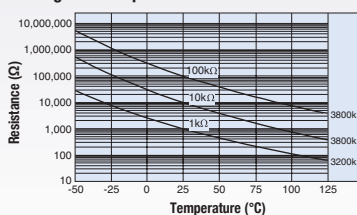

Platinum Thermal Sensors

Chip Type Sensor - SDT73H/V/S

- T.C.R.: 3850 ± 50 ppm/K in accordance with IEC 60751⁻¹⁹⁹⁵
- **SDT73H:** Temperature up to $+155^\circ\text{C}$
- **SDT73V:** AEC-Q200 qualified, $+155^\circ\text{C}$
- **SDT73S:** Temperature up to $+250^\circ\text{C}$
- Resistances: 100Ω or 500Ω
- Resistance tolerance: $\pm 0.2\%$, $\pm 1\%$

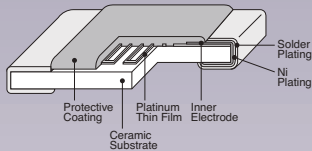

Axial Type - SDT101A/SDT101B

- -55 to $+300^\circ\text{C}$ operating temperature
- Resistances: 10Ω , 100Ω , 500Ω
- Resistance tolerance: $\pm 0.5\%$ or $\pm 1\%$
- T.C.R.: ± 3500 ppm/K $\pm 1\%$ or $\pm 2\%$

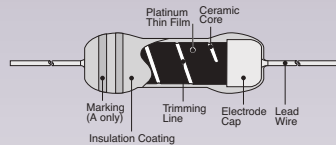

Small Type - SDT310

- T.C.R.: 3850 ppm/K in accordance with IEC 60751, JIS C 1604
- Radial and axial styles
- Stability classes A, B or C available
- Class A: $\pm(0.15 + 0.002|t|)^\circ\text{C}$
- **SDT310VASP:** Axial, ultra small heater element, $(2 \times 0.4 \times 0.65\text{mm})$, 20Ω at 0°C , $+600^\circ\text{C}$, 3.2 sec thermal time constant
- **SDT310AP:** Axial, $(3 \times 0.8 \times 1.2\text{mm})$, 10Ω at 0°C
- **SDT310HCTP:** Radial, $(3 \times 1.2 \times 1.1\text{mm})$, 100Ω
- **SDT310LTC:** Radial, temp. up to $+155^\circ\text{C}$
- **SDT310P:** Radial, temp. up to $+400^\circ\text{C}$
- **SDT310MTM:** Radial, temp. up to $+650^\circ\text{C}$, 100Ω
- **SDT310HLTC:** Radial, 2.8 sec thermal time constant

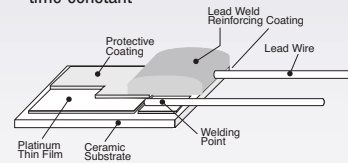

Custom Configurations -

ST Series/AFS Units

- Customer configurations based on use of SDT101 and SDT310 products

Applications for Temperature Compensation

- Flow sensor (automobiles, industrial equipment, home appliances)
- Measuring equipment (electric scale, load cell, flow sensors, automobiles)
- Cold junction compensation of thermocouple temperature controllers

Fuses

Fusing Flat Chip Resistors - RF73

- Resistance range: $0.2\Omega \sim 510\Omega$
- Resistance Tolerance: $\pm 5\%$
- Sizes available: 0603 \sim 2512

Chip Current Fuses - TF

- Rated current: $0.2\text{A} \sim 5\text{A}$
- Rated voltage: 24V & 32V
- Sizes available: 0402 & 0603
- TF16AT: Anti pulse

NEW TF16VN: 0603 for Automotive

- Rated current: **0.4A** \sim 3.15A
- Rated voltage: 32V

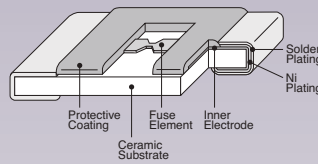

Micro-Fuse - CCP

- UL 248.14 approved, File #131375
- Fusing Current: $1\text{A} \sim 10\text{A}$
- Rated Voltage: $24\text{V} \sim 76\text{V}$
- Sizes available: 1206 & 1210

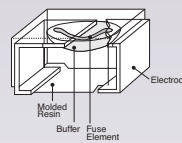

Chip Fuse - CCF1N

- Square ceramic body
- Size: $6.0 \times 2.5 \times 2.5$ mm
- Up to AC125V and DC160V
- UL248.14, c-UL(CSA)C22.2
- Rated current: $0.4\text{A} \sim 15\text{A}$

Chip Fuse - CCF1F

- Fast acting
- Meets IEC60127-4 specifications (Universal modular fuse-links standard sheet 2)

Varistors

Metal Oxide Chip - NV73

- Protects against static electricity, switching and incoming surges
- Varistor voltage: $8\text{Vc} \sim 165\text{Vc}$
- Sizes available: 0201 \sim 2220
- Maximum energy: $0.005\text{J} \sim 14.0\text{J}$

Automotive Metal Oxide Chip - NV73DL

- Conforming to AEC-Q200
- Low leakage current
- Operating temperature: up to $+125^\circ\text{C}$
- Varistors voltage: $10 \sim 90$ V_{1mA}
- Sizes available: 0603, 0805 & 1206

Chip Varistor for Load Dump Surge - NV73DS

- Meets load dump surge test of JASO
- High energy power - comparable to power zener diodes
- Size: $6.1 \times 5.1 \times 3.7$ mm (2420 inch)
- Varistor voltage: $20 \sim 25\text{V}$; $40 \sim 45\text{V}$ _{1mA}
- Max. load dump surge energy: $63\text{J} \sim 70\text{J}$

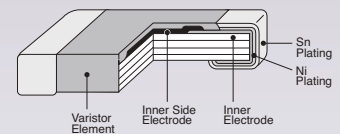



Inductors

Coil solutions on different cores cover an application range from RF to power by using ferrite, ceramic and choke coil technologies.

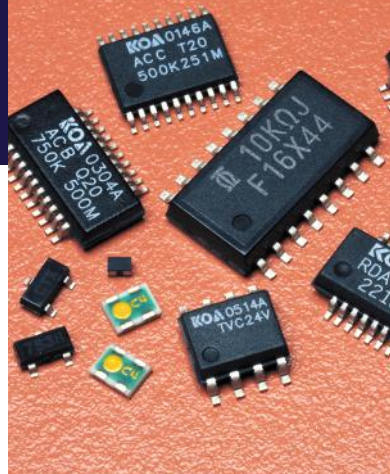

Integrated Components

Improve performance, save space and lower costs by combining components using our thin film, silicon based, multi-element technology.



Wirewound

High Q Air Core - KQ/KQT

- High self resonant frequency
- Ideal for low loss, high output power consumption
- Q Factor min.: 16 ~ 65
- Inductance range: 1.0nH ~ 10μH
- Inductance tolerance: ±0.1nH ~ ±20%
- Sizes available: 0402, 0603, 0805 & 1008

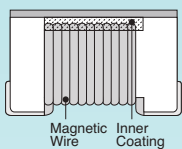

High Current Air Core - KQC

- Low DC resistance, high allowable DC current
- Nominal inductance: 1.4nH ~ 27nH
- Allowable currents up to 2.25A
- Inductance tolerance: ±0.1nH ~ ±5%
- Sizes available: 0402, 0603

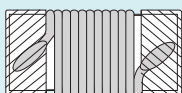

Choke Coils

Power - LPC 4045

- Non-shielded construction with bottom terminations
- Size: ø 4mm
- DC current max.: 3.1A
- Inductance range: 1μH ~ 680μH
- Inductance tolerance: ±10% or ±20%

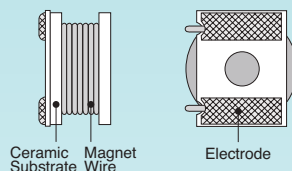

Power - LPC 4235/LPC 4545

- Non shielded construction with bottom and side terminations
- Sizes: 4.5x4.2 / 4.1x4.6mm
- AEC-Q200 qualified
- DC current max.: 0.07A ~ 3.66A
- Inductance range: 0.82μH ~ 2200μH
- Inductance tolerance: ±10% or ±20%

LPC4235 (3.5mm height)

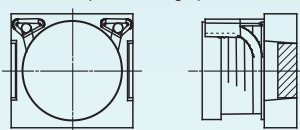

LPC4545 (4.6mm height)

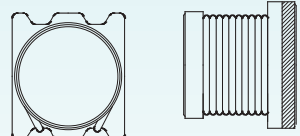

Resistor Networks

KOA's Integrated Passive Components - KPC

- Thin film (metal film) resistor array on Silicon wafer
- Excellent resistance matching, TCR tracking and stability
- Custom circuits are available with flexible layout (Different resistance combinations possible)
- Higher Integration saves board space and overall assembly costs
- Excellent reliability with standard molded IC package
- Suitable for reflow soldering
- Standard packagings:
SOT-23
QSOP 16, QSOP 20, QSOP 24
SOIC-N08, SOIC-N14, SOIC-N16

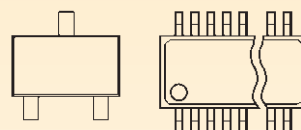

- Typical applications
 - Highly accurate peripheral resistors for analog operational amplifiers
 - Automotives, Analog instrumentations, IC-testers
 - Computers, Data communications, Network systems
 - Operational amplifiers, Terminations, Pull-up/Pull-down
 - Meets or exceeds IEC 60115-1, JIS C 5201-1, JIS C 5101-1

Isolated Resistors - RIA

- Precision value matching
- Absolute resistance tolerances: ±0.1%, ±0.25%, ±0.5%, ±1%, ±5%
- Relative resistance tolerances: 0.05% ~ 2%
- T.C.R.: ±10, ±25, ±50, ±100ppm/K
- T.C.R. tracking: 5ppm/K ~ 50 ppm/K
- Resistance range: 10Ω ~ 510kΩ

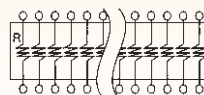

Resistor Networks

Bussed Resistors

- Standard Combinations
 - Bussed – RBA
 - High speed bussed – RBB
 - Dual terminator – RDA
 - Differential terminator – RDB
 - R2R network – RLA
 - SOT-23 network – RTX, RTY
 - Custom – RNX
- T.C.R.: ±10ppm/K ~ ±100ppm/K
- Resistance range: 10Ω ~ 100kΩ

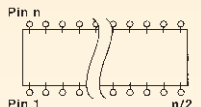
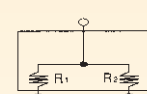
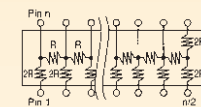
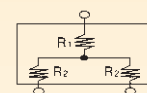
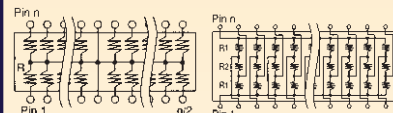
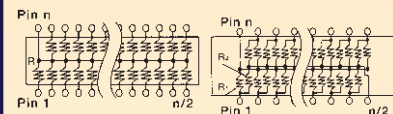

Custom Resistor Networks

NEW High Voltage Divider – HVD

- Thin film technology
- 1000V max. working voltage
- 0.1% ratio tolerance
- 10ppm ratio TC matching
- Resistance ratio selectable from 1:10 to 1:1000
- R1 (High R): 0.5MΩ ~ 11.5MΩ
- R2 (Low R): 4.5kΩ ~ 1MΩ

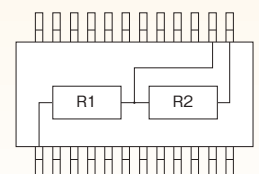

LTCC Low Temperature Co-fired Ceramic Substrates

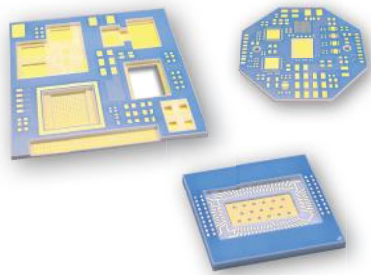

General Information about LTCC

Technology

Low Temperature Co-fired Ceramic is a multilayer ceramic technology that allows for moderate firing temperatures. The LTCC process is similar to the thick film hybrid process employed for multilayer ceramic capacitor and chip inductors. The moderate firing temperature level below 900 °C is achieved by mixing alumina and glass as main ingredients of the ceramic tape, the so-called green sheets. This permits the co-firing with highly conductive material (silver) for the electrodes. LTCC also support the creation of buried components and thus contribute to miniaturization.

Shrinkage Control

The LTCCs are fired under free shrinkage conditions: The material is allowed to shrink in all three dimensions.

The highly homogeneous structure of the green sheets and precise process control ensures high reproducibility of the dimensional accuracy. Relative accuracies of 0.05 % can be achieved. This high accuracy allows for the realization of dimensionally accurate cavities for the mounting of bare die semiconductor chips.

Features

- Excellent dimensional accuracy by KOA's original shrinkage control technology
- Multi layer technology up to 20 layers (more than 20 layers available on request)
- Surface Flatness down to $\pm 5 \mu\text{m}$ on request
- High-density wiring by fine line patterning
- Miniaturization by buried R, L, C and strip-lines
- Back volumes and channels
- Excellent high frequency performance up to 60 GHz by the use of low loss ceramics and conductors
- Thermal expansion coefficient similar to Si and GaAs
- Precision cavities enable bare chip mounting with short bond wires
- Thermal vias under bare chips enhance heat transport
- Superior heat and humidity resistance
- Optical transparent capping
- Brazing service
- Balling

Special KOA-KLC Material

- Stack accuracy: 20 μm max.
- Line width as low as 60 μm
- Line-to-line spacing as low as 60 μm
- Substrate flatness: 30 μm max.
- Via diameter: 100 μm , 150 μm , 200 μm
- Through-via pad diameter: Via diameter +50 μm min.
- Cavity width: 600 μm min.
- Cavity depth: 100 μm min.
- Cavity wall thickness: 500 μm min
- Flexural/bending strength: 250MPa
- Coefficient of Thermal Expansion: 5.5ppm/K
- Thermal conductivity: 3W/m • K
- Minimum insulation resistance: $1 \times 10^{12} \Omega \cdot \text{cm}$
- Dielectric constant at 1GHz: 6.6
- Dielectric loss at 1GHz: 0.004
- Density: 2.8g/cm³
- Max. surface roughness (Ra): 0.4 μm
- Min. withstanding voltage: 15kV/mm
- Fired layer thickness: 40 μm ~ 125 μm

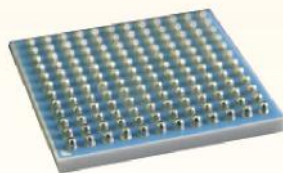
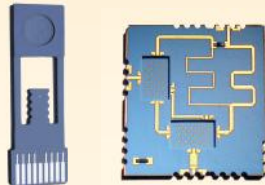

VIA Electronic Product Advantages

- High integration density
- Adaptation to constructive integration conditions
- 3D Integration
- Excellent reliability performance
- Outstanding RF performance
- Passive integration of RF elements
- High accuracy printed resistors
- Embedded resistors and coils
- Integrated channels and chambers for fluidic applications or gas sensors
- Stability against aggressive media
- Hermetic density
- Thermal management
- Thick film on inorganic substrates

Variety of Material Systems

Different commercial and qualified LTCC material systems for hermeticity, low dielectric losses and leadfree applications are used.

Packages

Fluxless vacuum soldering process is offered to provide the packages (the housing) to which other components i.e. heatsinks, ringframes, leadframes are attached to achieve the required performance of heat dissipation, hermeticity and low ohmic contacts to the system.

Advanced Thick-Film Technology

The fabrication of printed circuits with integrated resistors and different metallisations are offered, based on ceramic substrates, glasses and metals including a specific thick copper technique for power connections.

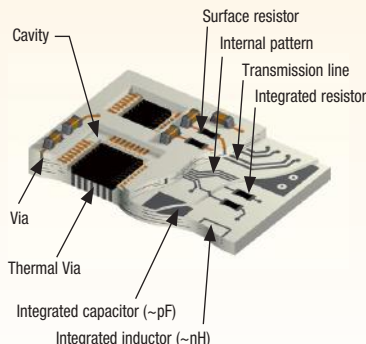

Available Material Systems at VIA

DuPont 951

- High integration density, super high frequency
- Compatible to all interconnection and packaging technologies (IPT)
- High-reliability system
- Cost efficient mixed metal system

DuPont 9K7

- Low Loss
- High integration density, extremely high frequency
- Gold and mixed metal system
- No lead

Other materials

- Heraeus CT 700, CT708, CT765
- Ceramtape GC
- Ferro A6M
- others

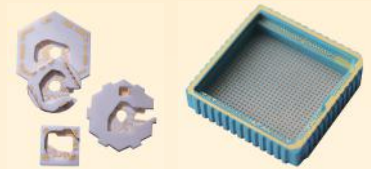

Applications:

- Controller electronics with high integration density
- RF electronics up to 77 GHz and more
- Hermetic and quasi hermetic packages
- Packages for microsystems and sensors
- Ceramic microsystems and sensors
- MOEMS packages
- Multichip modules
- Interposer substrates for semiconductor dies

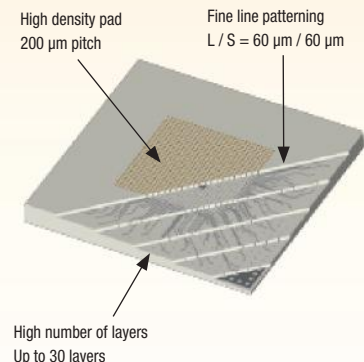



Leaded Resistors

The industry's broadest line of leaded resistors and networks include designs with various material composition and structure for use in general purpose, precision, anti-surge, high voltage, high resistance, PTC and fusing applications.



Carbon film

General Purpose - Reduced Size and Flame Proof CF/CFB/CFS/CFP Series

- Power rating: 0.25W ~ 0.5W
- Resistance range: 2.2Ω ~ 5.1MΩ
- Tolerance: ±2% or ±5%

High Power Resistor - SPR and SPRX

- Power rating: 0.25W ~ 5W
- Resistance range: 0.1Ω ~ 110kΩ
- Tolerance: ±1%, ±2% or ±5%

Metal film

General purpose - Reduced Size MF/MFP/MFS/SN Series

- Power rating: 0.25W ~ 2W
- Resistance range: 0.51Ω ~ 5.11MΩ
- Tolerance: ±0.1% ~ ±5%
- T.C.R.: ±50 ~ ±200 ppm/K

Precision - RNS Series

- Power rating: 0.125W ~ 1W
- Resistance range: 0.2Ω ~ 6.8MΩ
- Tolerance: ±0.1% ~ ±1%
- T.C.R.: 5 ~ 50 ppm/K

Metal Oxide

Reduced Size - MOS/MOSX Series

- Power rating: 0.5W ~ 5W
- Resistance range: 0.1Ω ~ 100kΩ
- Tolerance: ±1%, ±2% or ±5%
- T.C.R.: ±300 ppm/K

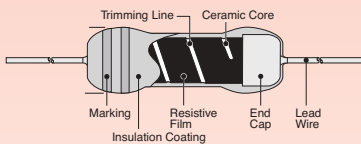

Power Type - BSR Series

- Rectangular ceramic case
- Power rating: 2W ~ 20W
- Resistance range: 430Ω ~ 75kΩ
- Tolerance: ±5%
- T.C.R.: ±300 ppm/K

NEW Power Type – BSRV Series (Automotive)

- Rectangular ceramic case
- Power rating: 5W ~ 20W
- Resistance range: 430Ω ~ 75kΩ
- Resistance tolerance: ±5%
- T.C.R.: ±300ppm/K

Wirewound

Miniature Type - CW/CWP/CWH/CWS/CWX Series

- Power rating: 0.25W ~ 5W
- Resistance range: 0.1Ω ~ 3kΩ
- Tolerance: ±0.25% ~ ±10%

Fusing Function – CWFS Series

- Fail-safe mains fusing at AC 250V (10Ω ~ 100Ω); AC 200V (4.7Ω ~ 9.1Ω)
- UL1412 recognized (File No. E134679)
- Power rating: 3W, 5W
- T.C.R.: ±100ppm/K
- Size: 12 x 4mm, 15 x 6mm

Power - RW/RWN Series

- RWN: Non-inductive winding
- Power rating: 0.5W ~ 14W
- Resistance range: 0.1Ω ~ 62kΩ
- Tolerance: ±0.5% ~ ±5%

Power Rectangular Type - BGR, BWR Series

- Rectangular ceramic case
- BGR with glass core
- BWR with ceramic core
- Power rating: 1W ~ 40W
- Resistance range: 0.1Ω ~ 390Ω
- Tolerance: ±1% ~ ±10%

NEW Power Type – BGRV Series (Automotive)

- Glass core in rectangular ceramic case
- Power rating: 7W ~ 40W
- Resistance range: 5.1Ω ~ 390Ω
- Resistance tolerance: ±5%, ±10%
- T.C.R.: ±250ppm/K

High Voltage/High Power - P Series

- Special shape parts
- Power rating: up to 250W
- Working voltage: up to 300 kV

Leaded SIP networks

Thick Film - RKC/RKH/RKL Series

- Number of pins: 3 ~ 16
- Resistance range: 10Ω ~ 2.2MΩ
- Tolerance: ±1% ~ ±5%
- Various circuit and custom parts available

Precision Metal film - MRP

- Resistance range: 50Ω ~ 100kΩ
- Absolute tolerance: ±0.1% ~ ±1%
- Ratio tolerance: 0.025% ~ 0.5%

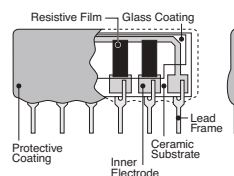

Zero Ohm/Jumper

Conformal coated - Z Series

- Max. allowable current: 1.5A, 2.5A
- Resistance: less than 20mΩ

Molded - J Series

- Max. allowable current: 8A, 10A
- Sizes: 3.4 x 1.7mm, 6.5 x 2.3 mm

Jumper Wire - JL Series

- Max. allowable current: 8A, 10A
- Wire diameter: 0.5 or 0.6mm

Specialty

Anti-Surge, Metal Glaze - RCR Series

- Awarded UL1676, EN60065, EN62368-1 & c-UL approvals
- Max. working voltage: 500V ~ 5000V
- Power rating: 0.25W ~ 3W
- Resistance range: 3.3Ω ~ 100MΩ
- Tolerance: ±1% or ±5%

High Voltage, Metal Glaze - GS Series

- Max. working voltage: 0.5kV ~ 40kV
- Power rating: 0.25W ~ 12W
- Resistance range: 0.5MΩ ~ 10GΩ
- Tolerance: ±0.5% ~ ±10%

High Voltage, Thick Film – RK92-L Series

- Excellent overload capability
- Charge and discharge res. for power supply
- Power rating: 4W
- Resistance range: 1.2MΩ ~ 16MΩ
- SIP shape, Pitch: 45mm



Ceramic Composition - PCF/HPC/CPCN Series

- KOA original ceramic resistor
- Excellent characteristic against high voltage surge current
- Available as PTH or without leads (CPCN)
- CPCN is suitable as noise suppressor of engine ignition circuit systems
- Power rating: 0.5W ~ 5W
- Resistance range: 3.3Ω ~ 390kΩ
- Tolerance: ±10% or ±20%

Current Sensing Rectangular Type - BPR Series

- Power rating: 2W ~ 14W
- Resistance range: 0.01Ω ~ 1Ω
- Tolerance: ±5% or ±10%
- Twin type with 3 leads available

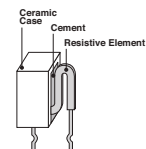

Linear Thin Film PTC - LP Series

- Resistance range: 1Ω ~ 30kΩ
- Tolerance: ±1%, ±2%, ±5%
- T.C.R.: 150ppm/K ~ 5000ppm/K
- T.C.R.: Tolerance: ±50ppm/K, ±5%, ±10%

Fusing Resistors - RF Series

- Power rating: 0.17W ~ 2W
- Resistance range: 0.1Ω ~ 15kΩ
- Tolerance: ±5%
- **RF25CC**: constant current fusing type

For an Innovative Partnership

KOA Europe... In Dägeling, Product and Application Engineers, together with an experienced Sales Force and a dedicated Customer Service Team, share one focus: our mutual growth and success.

Such aspirations necessitate all-round competence including continuous efforts in:

- A wide programme of passive components
- Product innovations
- Superior Customer Support
- Total Quality Management
- Custom-built logistic packages
- Competitive prices

Logistics is the key to efficiency and worldwide success.

KOA Europe runs a warehouse with approx. 2 billion pieces stock on hand to support customers within 24 hours with the most common parts. Our experts are pleased to share their experience with you:

- JIT shipments
- Customer specific labelling
- Full range of EDI possibilities
- Electronic incoming and dispatch control
- Consignment Stock

Continuous improvement is a "must" for today's global business

- We achieved ISO 9001 certification the year following our foundation
- Moreover, KOA's production plants are ISO/TS 16949 and ISO 14001 approved

Technical Support plays a critical role in helping customers to improve product quality.

KOA's technical staff is highly trained in:

- Development of new products
- Design-In
- Application Engineering
- Product Performance Characteristics

Even with all this expertise, a company can only be as good as its Customer Service Team. At KOA you will find:

- Competent and reliable partners for your enquiries
- A multi-lingual team
- Automated order and sample processing
- Prompt, efficient responses

And yet continuous improvement is our goal. Constant staff training is one means by which we are aiming to achieve it, good communication with you is another.

Your KOA Europe Team

The KOA logo consists of the letters 'KOA' in a bold, sans-serif font. The 'K' is blue, and the 'O' and 'A' are dark blue.

EUROPE GMBH

Kaddenbusch 6
D-25578 Dägeling/Itzehoe
Germany

Phone : +49 (0)4821/8989-0
Fax : +49 (0)4821/898989
E-Mail : info@koaeurope.de
Internet : www.koaeurope.de

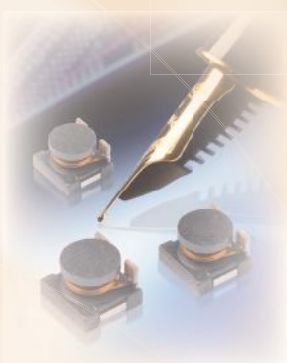
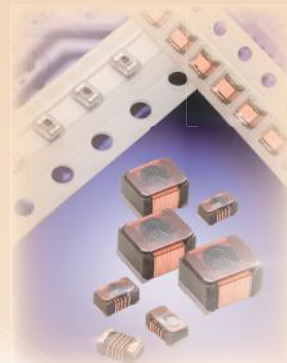
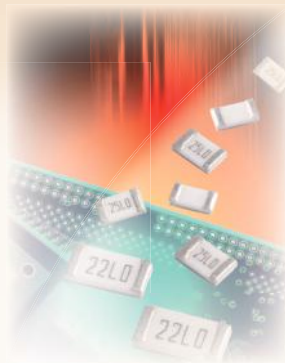
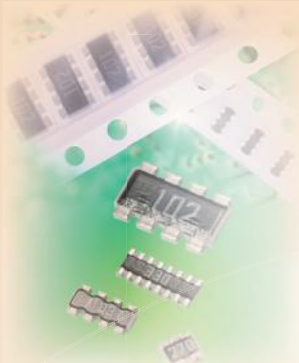
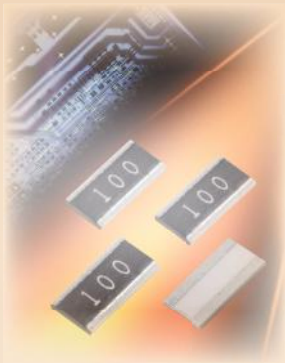

Looking for pricing, stock, or lifecycle information?

Click below to explore more details on WIN SOURCE:

- ⊖ [View RN73R1JTTD1112D25 on WIN SOURCE](#)
- ⊖ [KOA Speer Information](#)

Optimize Your Supply Chain with WIN SOURCE Solutions

- ✓ Global Sourcing Solution
- ✓ Obsolete Management
- ✓ Cost Control Management
- ✓ Shortage Management
- ✓ Alternative Solution
- ✓ Excess Inventory Management