



**THE DATASHEET OF  
AD9082BBPZRL-2D2AC**



**FEATURES****Flexible reconfigurable common platform design**

- 4 DACs and 2 ADCs (4D2A) and 2D2A options
- Supports single, dual, and quad band
- Datapaths and DSP blocks are fully bypassable
- DAC to ADC sample rate ratios of 1, 2, 3, and 4
- On-chip PLL with multichip synchronization
- External RFCLK input option for off-chip PLL

**Maximum DAC sample rate up to 12 GSPS**

- Maximum data rate up to 12 GSPS using JESD204C
- Useable analog bandwidth to 8 GHz

**Maximum ADC sample rate up to 6 GSPS**

- Maximum data rate up to 6 GSPS using JESD204C
- Useable analog bandwidth to 8 GHz

**ADC ac performance at 6 GSPS, input at 2.7 GHz, -1 dBFS**

- Full-scale input voltage: 1.475 V p-p
- Noise density: -147.5 dBFS/Hz
- Noise figure: 25.3 dB
- HD2: -72 dBFS
- HD3: -68 dBFS

Worst other (excluding HD2 and HD3): -78 dBFS

**DAC ac performance at 12 GSPS, output at 2.6 GHz**

- Full-scale output current range: 6.43 mA to 37.75 mA
- Two-tone IMD3 (-6 dBFS per tone): -72 dBc
- NSD, single-tone: -160 dBc/Hz
- SFDR, single-tone: 75 dBc

**Versatile digital features****Selectable interpolation and decimation filters****Configurable DDC and DUC**

- 8 fine complex DUCs and 4 coarse complex DUCs
- 8 fine complex DDCs and 4 coarse complex DDCs
- 48-bit NCO per DUC or DDC
- Option to bypass fine and coarse DUC/DDC

**Programmable 192-tap PFIR filter for receive equalization****Supports 4 different profile settings loaded via GPIO****Programable delay per data path****Receive AGC support**

- Fast detect with low latency for fast AGC control

**Signal monitor for slow AGC control****Dedicated AGC support pins****Transmit DPD support**

- Fine DUC channel gain control and delay adjust
- Coarse DDC delay adjust for DPD observation path

**Auxiliary features****Fast frequency hopping****Direct digital synthesis (DDS)****Low latency loopback modes (receive datapath data can be routed to the transmit datapaths)****ADC clock driver with selectable divide ratios****Power amplifier downstream protection circuitry****On-chip temperature monitoring unit****Flexible GPIO pins****TDD power savings option****SERDES JESD204B/C interface, 16 lanes up to 24.75 Gbps****8 lanes JESD204B/C transmitter (JT<sub>x</sub>) and 8 lanes****JESD204B/C receiver (JR<sub>x</sub>)****JESD204B compliance with the maximum 15.5 Gbps****JESD204C compliance with the maximum 24.75 Gbps****Supports real or complex digital data (8-, 12-, 16-, or 24-bit)****15 mm × 15 mm, 324-ball BGA with 0.8 mm pitch****APPLICATIONS****Wireless communications infrastructure****Microwave point to point, E-band, and 5G mmWave****Broadband communications systems****DOCSIS 3.1 and 4.0 CMTS****Phased array radar and electronic warfare****Electronic test and measurement systems****GENERAL DESCRIPTION**

The AD9082 mixed signal front-end (MxFE<sup>®</sup>) is a highly integrated device with four 16-bit, 12 GSPS maximum sample rate, RF digital-to-analog converter (DAC) cores, and two 12-bit, 6 GSPS maximum sample rate, RF analog-to-digital converter (ADC) cores. The AD9082 is well suited for applications requiring both wideband ADCs and DACs to process signal(s) that have wide instantaneous bandwidth. The device features eight transmit lanes and eight receive lanes that support 24.75 Gbps/lane JESD204C or 15.5 Gbps/lane JESD204B standards. The device also has an on-chip clock multiplier and digital signal processing (DSP) capability targeted at either wideband or multiband, direct to RF applications. The DSP datapaths can be bypassed to allow a direct connection between the converter cores and the JESD204B/C data transceiver port. The device also features low latency loopback, frequency hopping modes, and datapath multiplexer (mux) configurations useful for phase array radar system and electronic warfare applications. Two models for the AD9082 are offered. The 4D2AC model supports four DACs and two ADCs. The 2D2AC model supports two DACs and two ADCs. See the Ordering Guide for more information.

## TABLE OF CONTENTS

Features .....	1	JESD204B and JESD204C Interface Electrical and Speed Specifications .....	10
Applications .....	1	CMOS Pin Specifications .....	11
General Description .....	1	DAC AC Specifications .....	11
Revision History .....	2	ADC AC Specifications .....	14
Functional Block Diagram .....	3	Timing Specifications .....	16
Specifications .....	4	Absolute Maximum Ratings .....	17
Recommended Operating Conditions .....	4	Thermal Resistance .....	17
Power Consumption .....	4	ESD Caution .....	17
DAC DC Specifications .....	5	Pin Configuration and Function Descriptions .....	18
ADC DC Specifications .....	5	Typical Performance Characteristics .....	23
Clock Inputs and Outputs .....	6	DAC .....	23
Clock Input and Phase-Locked Loop (PLL) Frequency Specifications .....	6	ADC .....	28
DAC Sample Rate Specifications .....	7	Theory of Operation .....	35
ADC Sample Rate Specifications .....	7	Outline Dimensions .....	36
Input and Output Data Rate Specifications .....	8	Ordering Guide .....	36
NCO Frequency Specifications .....	9		

## REVISION HISTORY

### 6/2021—Rev. B to Rev. C

Changes to Table 20 .....	17
---------------------------	----

### 3/2021—Rev. A to Rev. B

Changes to Features Section and General Description Section .....	1
Changes to Figure 1 .....	3
Changes to Specifications Section .....	4
Deleted DC Specifications Section and Table 2; Renumbered Sequentially .....	4
Added DAC DC Specifications Section, Table 3, ADC DC Specifications Section, and Table 4; Renumbered Sequentially .....	5
Deleted DAC and ADC Sampling Specifications Section .....	5
Added Clock Inputs and Outputs Section and Table 5 .....	6
Added DAC Sample Rate Specifications Section, Table 7, ADC Sample Rate Specifications Section, and Table 8 .....	7
Deleted Table 6 .....	7
Added Table 9 .....	8
Deleted Table 7 .....	8

Added NCO Frequency Specifications Section and Table 10 .....	9
Added Table 11 and Table 12 .....	9
Added Table 13 and Table 14 .....	10
Changes to Table 19 and Table 20 .....	17
Changes to Table 21 .....	19
Changes to Pin Configuration and Function Descriptions Section and Figure 5 .....	18
Changes to Typical Performance Characteristics Section .....	23
Changes to Theory of Operation Section .....	35
Changes to Ordering Guide .....	36

### 9/2020—Rev. 0 to Rev. A

Changes to Figure 1 .....	3
Changes to Figure 5 .....	16
Changes to Table 14 .....	17

### 6/2020—Revision 0: Initial Version

# FUNCTIONAL BLOCK DIAGRAM

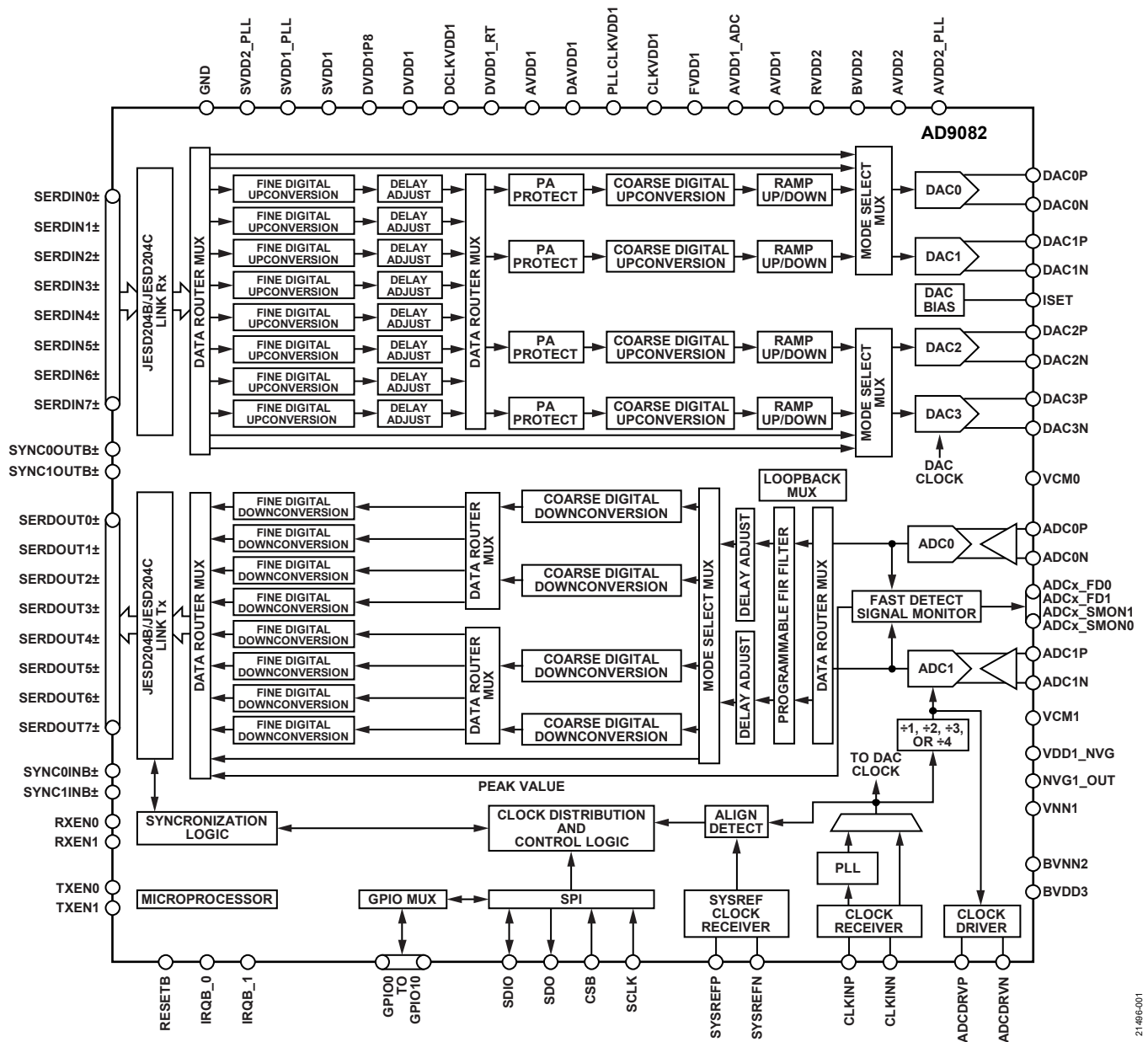

Figure 1.

21-496-001

## SPECIFICATIONS

### RECOMMENDED OPERATING CONDITIONS

Successful DAC calibration is required during the device initialization phase that occurs shortly after power-up to ensure long-term reliability of the DAC core circuitry. Refer to the [UG-1578](#) user guide for more information on device initialization.

Table 1.

Parameter	Min	Typ	Max	Unit
OPERATING JUNCTION TEMPERATURE (T <sub>J</sub> )	-40		120	°C
ANALOG SUPPLY VOLTAGE RANGE				
AVDD2, BVDD2, RVDD2	1.9	2.0	2.1	V
AVDD1, AVDD1_ADC, CLKVDD1, FVDD1, VDD1_NVG1	0.95	1.0	1.05	V
DIGITAL SUPPLY VOLTAGE RANGE				
DVDD1, DVDD1_RT, DCLKVDD1, DAVDD1	0.95	1.0	1.05	V
DVDD1P8	1.7	1.8	2.1	V
SERIALIZER/DESERIALIZER (SERDES) SUPPLY VOLTAGE RANGE				
SVDD2_PLL	1.9	2.0	2.1	V
SVDD1, SVDD1_PLL	0.95	1.0	1.05	V

### POWER CONSUMPTION

Typical at nominal supplies and maximum at 5% supplies. For the minimum and maximum values, T<sub>J</sub> was varied between -40°C and +120°C. For the typical values, T<sub>A</sub> = 25°C, unless otherwise noted.

DAC datapath with two DAC channels enabled. Complex I/Q data rate frequency (f<sub>IQ,DATA</sub>) = 3000 MSPS, interpolation of 4×, DAC frequency (f<sub>DAC</sub>) = 12 GSPS, and JESD204C mode of 15C (L = 8, M = 4, F = 1, S = 1, K = 128, E = 1, N = 16, NP = 16).

ADC datapath with two ADC channels enabled. ADC frequency (f<sub>ADC</sub>) = 6 GSPS, decimation filters bypassed, and JESD204C mode of 19C (L = 8, M = 2, F = 1, S = 2, K = 256, E = 1, N = 16, NP = 16).

See the [UG-1578](#) user guide for further information on the JESD204B and JESD204C mode configurations and a detailed description of the settings referenced throughout this data sheet.

Table 2.

Parameter	Test Conditions/Comments	Min	Typ	Max	Unit
CURRENTS					
AVDD2 (I <sub>AVDD2</sub> )	2.0 V supply		105	110	mA
BVDD2 (I <sub>BVDD2</sub> ) + RVDD2 (I <sub>RVDD2</sub> )	2.0 V supply		290	340	mA
AVDD2_PLL (I <sub>AVDD2_PLL</sub> ) + SVDD2_PLL (I <sub>SVDD2_PLL</sub> )	2.0 V supply		45	55	mA
Power Dissipation for 2 V Supplies	2.0 V supply total power dissipation		0.9	1.0	W
PLLCLKVDD1 (I <sub>PLLCLKVDD1</sub> )	1.0 V supply		15	25	mA
AVDD1 (I <sub>AVDD1</sub> ) + DCLKVDD1 (I <sub>DCLKVDD1</sub> )	1.0 V supply		620	795	mA
AVDD1_ADC (I <sub>AVDD1_ADC</sub> )	1.0 V supply		1710	2095	mA
CLKVDD1 (I <sub>CLKVDD1</sub> )	1.0 V supply		90	150	mA
FVDD1 (I <sub>FVDD1</sub> )	1.0 V supply		45	80	mA
VDD1_NVG (I <sub>VDD1_NVG</sub> )	1.0 V supply		280	360	mA
DAVDD1 (I <sub>DAVDD1</sub> )	1.0 V supply		925	1130	mA
DVDD1 (I <sub>DVDD1</sub> )	1.0 V supply		2175	3175	mA
DVDD1_RT (I <sub>DVDD1_RT</sub> )	1.0 V supply		560	680	mA
SVDD1 (I <sub>SVDD1</sub> ) + SVDD1_PLL (I <sub>SVDD1_PLL</sub> )	1.0 V supply		1850	2500	mA
Power Dissipation for 1 V Supplies	1.0 V supply total power dissipation		8.3	11.0	W
DVDD1P8 (I <sub>DVDD1P8</sub> )	1.8 V supply		7	10	mA
Total Power Dissipation	Total power dissipation of 2 V and 1 V supplies		9.2	12	W

**DAC DC SPECIFICATIONS**

Nominal supplies with DAC output full-scale current ( $I_{OUTFS}$ ) = 26 mA, unless otherwise noted. ADC setup in 6 GSPS, full bandwidth mode (all digital downconverters bypassed). For the minimum and maximum values,  $T_J = -40^\circ\text{C}$  to  $+120^\circ\text{C}$ , and for the typical values,  $T_A = 25^\circ\text{C}$ , which corresponds to  $T_J = 80^\circ\text{C}$ , unless otherwise noted.

**Table 3. DAC DC Specifications**

Parameter	Test Conditions/Comments	Min	Typ	Max	Unit
DAC RESOLUTION		16			Bit
DAC ACCURACY					
Gain Error			1.5		% FSR
Gain Matching			0.7		% FSR
Integral Nonlinearity (INL)	Shuffling disabled		8.0		LSB
Differential Nonlinearity (DNL)	Shuffling disabled		3.5		LSB
DAC ANALOG OUTPUTS	DACxP and DACxN				
Full-Scale Output Current Range	AC coupling, setting resistance ( $R_{SET}$ ) = 5 k $\Omega$				
AC Coupling	Output common-mode voltage ( $V_{CM}$ ) = 0 V	6.43	26.5	37.75	mA
DC Coupling	50 $\Omega$ shunt to a negative supply, forcing $V_{CM} = 0$ V	6.43		37.75	mA
	50 $\Omega$ shunt to GND, forcing $V_{CM} = 0.3$ V	6.43		20 <sup>1</sup>	mA
Full-Scale Sine Wave Output Power with AC Coupling <sup>2</sup>	Ideal 2:1 balun interface to 50 $\Omega$				
$I_{OUTFS} = 26.5$ mA			3.3		dBm
$I_{OUTFS} = 37.75$ mA			7		dBm
Common-Mode Output Voltage ( $V_{CMOUT}$ )			0		V
AC Coupling	Bias each output to GND across a shunt inductor		0		V
DC Coupling	Bias each output to a negative voltage rail across a 25 $\Omega$ to 200 $\Omega$ resistor, selected such that $V_{CMOUT} = 0$ V, $V_{CMOUT} = 0.3$ V with a 25 $\Omega$ resistor to GND, and $I_{OUTFS} = 20$ mA		0	0.3	V
Differential Resistance			100		$\Omega$

<sup>1</sup> For dc-coupled applications, the maximum full-scale output current is limited by the maximum  $V_{CMOUT}$  specification.

<sup>2</sup> The actual measured full-scale power is frequency dependent due to DAC sinc response, impedance mismatch loss, and balun insertion loss.

**ADC DC SPECIFICATIONS**

Nominal supplies with ADC setup in 6 GSPS, full bandwidth mode (all digital downconverters bypassed). For the minimum and maximum values,  $T_J = -40^\circ\text{C}$  to  $+120^\circ\text{C}$ , and for the typical values,  $T_A = 25^\circ\text{C}$ , which corresponds to  $T_J = 80^\circ\text{C}$ , unless otherwise noted.

**Table 4. ADC DC Specifications**

Parameter	Test Conditions/Comments	Min	Typ	Max	Unit
ADC RESOLUTION		12			Bit
ADC ACCURACY					
No Missing Codes			Guaranteed		
Offset Error			0.04		% FSR
Offset Matching			0.03		% FSR
Gain Error			1.5		% FSR
Gain Matching			0.6		% FSR
DNL			0.32		LSB
INL			1.38		LSB
ADC ANALOG INPUTS	ADCxP and ADCxN				
Differential Input Voltage			1.475		V p-p
Full-Scale Sine Wave Input Power	Input power level resulting 0 dBFS tone level on fast Fourier transform (FFT)		3.9		dBm
Common-Mode Input Voltage ( $V_{CMIN}$ )	AC-coupled, equal to voltage at $V_{CMx}$ for ADCx input		1		V
Differential Input Resistance			100		$\Omega$
Differential Input Capacitance			0.4		pF
Return Loss	<2.7 GHz		-4.3		dB
	2.7 GHz to 3.8 GHz		-3.6		dB
	3.8 GHz to 5.4 GHz		-2.9		dB

## CLOCK INPUTS AND OUTPUTS

For the minimum and maximum values,  $T_j = -40^\circ\text{C}$  to  $+120^\circ\text{C}$  and  $\pm 5\%$  of nominal supply, unless otherwise noted. For the typical values,  $T_A = 25^\circ\text{C}$ , which corresponds to  $T_j = 80^\circ\text{C}$ , unless otherwise noted.

**Table 5. Clock Inputs and Outputs**

Parameter	Test Conditions/Comments	Min	Typ	Max	Unit
<b>CLOCK INPUTS</b>					
Differential Input Power	CLKINP and CLKINN Direct RF clock				
Minimum				0	dBm
Maximum				6	dBm
Common-Mode Voltage	AC-coupled			0.5	V
Differential Input Resistance				100	$\Omega$
Differential Input Capacitance				0.3	pF
<b>CLOCK OUTPUTS (ADC CLOCK DRIVER)</b>					
Differential Output Voltage Magnitude <sup>1</sup>	ADCDRVP and ADCDRVN				
	1.5 GHz			740	mV p-p
	2.0 GHz			690	mV p-p
	3 GHz			640	mV p-p
	6 GHz			490	mV p-p
Differential Output Resistance				100	$\Omega$
Common-Mode Voltage	AC-coupled			0.5	V

<sup>1</sup> Measured with a differential  $100\ \Omega$  load and less than 2 mm of printed circuit board (PCB) trace from the package ball.

## CLOCK INPUT AND PHASE-LOCKED LOOP (PLL) FREQUENCY SPECIFICATIONS

For the minimum and maximum values,  $T_j = -40^\circ\text{C}$  to  $+120^\circ\text{C}$  and  $\pm 5\%$  of nominal supply, unless otherwise noted. For the typical values,  $T_A = 25^\circ\text{C}$ , which corresponds to  $T_j = 80^\circ\text{C}$ , unless otherwise noted.

**Table 6. Clock Input and PLL Specifications**

Parameter	Test Conditions/Comments	Min	Typ	Max	Unit
CLOCK INPUTS (CLKINP, CLKINN) FREQUENCY RANGES		25		12000	MHz
PHASE FREQUENCY DETECTOR (PFD) INPUT FREQUENCY RANGES		25		750	MHz
<b>FREQUENCY RANGES ACCORDING TO CLOCK PATH CONFIGURATION</b>					
Direct Clock (PLL Off)		2900 <sup>1</sup>		12000	MHz
PLL Reference Clock (PLL On) <sup>2</sup>	M divider set to divide by 1	25		750	MHz
	M divider set to divide by 2	50		1500	MHz
	M divider set to divide by 3	75		2250	MHz
	M divider set to divide by 4	100		3000	MHz
<b>PLL VOLTAGE CONTROLLED OSCILLATOR (VCO) FREQUENCY RANGES</b>					
VCO Output <sup>2</sup>	D divider set to divide by 1	5.8		12	GHz
	D divider set to divide by 2	2.9		6	GHz
	D divider set to divide by 3	1.93333		4	GHz
	D divider set to divide by 4	1.45		3	GHz

<sup>1</sup> The minimum direct clock frequency is limited by the minimum DAC (core) sample rate, as specified in Table 7. The clock receiver can accommodate the full range between the minimum PLL reference clock frequency and the maximum direct clock frequency.

<sup>2</sup> Refer to the [UG-1578](#) user guide for information on the M divider and the D divider.

**DAC SAMPLE RATE SPECIFICATIONS**

Nominal supplies. For the minimum and maximum values,  $T_J = -40^{\circ}\text{C}$  to  $+120^{\circ}\text{C}$  and  $\pm 5\%$  of nominal supply. For the typical values,  $T_A = 25^{\circ}\text{C}$ , unless otherwise noted.

**Table 7. DAC Sample Rate Specifications**

Parameter	Min	Typ	Max	Unit
DAC SAMPLE RATE <sup>1</sup>				
Minimum			2.9	GSPS
Maximum	12			GSPS

<sup>1</sup> Pertains to the update rate of the DAC core independent of the datapath and JESD204 mode configuration.

**ADC SAMPLE RATE SPECIFICATIONS**

Nominal supplies. For the minimum and maximum values,  $T_J = -40^{\circ}\text{C}$  to  $+120^{\circ}\text{C}$  and  $\pm 5\%$  of nominal supply. For the typical values,  $T_A = 25^{\circ}\text{C}$ , unless otherwise noted.

**Table 8. ADC Sample Rate Specifications**

Parameter	Min	Typ	Max	Unit
ADC SAMPLE RATE <sup>1</sup>				
Minimum			1.45	GSPS
Maximum	6			GSPS
Aperture Jitter <sup>2</sup>		65		fs rms

<sup>1</sup> Pertains to the update rate of the ADC core independent of the datapath and JESD204 mode configuration.

<sup>2</sup> Measured using a signal-to-noise ratio (SNR) degradation method with the DAC disabled, clock divider = 1,  $f_{\text{ADC}} = 6$  GSPS, and input frequency ( $f_{\text{IN}}$ ) = 5.55 GHz.

**INPUT AND OUTPUT DATA RATE SPECIFICATIONS**

For the minimum and maximum values,  $T_j = -40^{\circ}\text{C}$  to  $+120^{\circ}\text{C}$  and  $\pm 5\%$  of nominal supply, unless otherwise noted.

**Table 9.**

Parameter <sup>1,2</sup>	Test Conditions/Comments	Min	Typ	Max	Unit
MAXIMUM DATA RATE PER NUMBER OF ACTIVE DAC OUTPUTS	Single DAC, fine digital upconverter (FDUC) and coarse digital upconverter (CDUC) bypassed (1× interpolation), 16-bit resolution, limited by the maximum DAC clock rate			12000	MSPS
	Dual DAC FDUC and CDUC bypassed (1× interpolation), 16-bit resolution (M = 2, L = 8)			6000	MSPS
	Quad DAC, FDUC and CDUC bypassed (1× interpolation), 12-bit resolution, limited by the maximum JESD204C link throughput (M = 4, L = 8)			4000	MSPS
MAXIMUM COMPLEX I/Q DATA RATE PER NUMBER OF ACTIVE INPUT DATA CHANNELS	1 channel: FDUC bypassed, 1 CDUC enabled, 12-bit or 16-bit resolution, limited by the maximum CDUC numerically controlled oscillator (NCO) clock rate			6000	MSPS
	2 channels: FDUC bypassed, 2 CDUCs enabled, 12-bit resolution, limited by the maximum JESD204C link throughput (M = 4, L = 8)			4000	MSPS
	4 channels: FDUC bypassed, 4 CDUCs enabled, 12-bit resolution, limited by the maximum JESD204C link throughput (M = 8, L = 8)			2000	MSPS
	8 channels: 8 FDUCs enabled, one or more CDUCs enabled, 12-bit or 16-bit resolution, limited by the maximum FDUC NCO clock rate divided by the minimum 2× interpolation rate required to enable the FDUC			750	MSPS

<sup>1</sup> The values listed for these parameters are the maximum possible when considering all JESD204 modes of operation. Some modes are more limiting, based on other parameters.

<sup>2</sup> The interpolation filters in the Tx datapath have a total complex filter bandwidth of 80% of the data rate, combining the 40% bandwidth in the I path and 40% bandwidth in the Q path. Similarly, the decimation stages inside the Rx datapath use filters with a total complex filter bandwidth of 81.4%. Therefore, the maximum allowed instantaneous complex signal bandwidth (iBW) per channel is calculated as  $iBW = (\text{complex I/Q data rate per channel}) \times (\text{total complex filter bandwidth})$ .

**NCO FREQUENCY SPECIFICATIONS**

For the minimum and maximum values,  $T_j = -40^{\circ}\text{C}$  to  $+120^{\circ}\text{C}$  and  $\pm 5\%$  of nominal supply, unless otherwise noted.

**Table 10.**

Parameter	Test Conditions/Comments	Min	Typ	Max	Unit
MAXIMUM NCO CLOCK RATE					
FDUC NCO				1.5	GHz
CDUC NCO				12	GHz
Fine Digital Downconverter (FDDC) NCO				1.5	GHz
Coarse Digital Downconverter (CDDC) NCO				6	GHz
MAXIMUM NCO SHIFT FREQUENCY RANGE					
Channel NCO	Channel summing node = 1.5 GHz, channel interpolation rate $> 1\times$	-750		+750	MHz
Main DAC NCO	$f_{\text{DAC}} = 12$ GHz, main interpolation rate $> 1\times$	-6		+6	GHz
Main ADC NCO	$f_{\text{ADC}} = 6$ GHz, main decimation rate $> 1\times$	-3		+3	GHz
MAXIMUM FREQUENCY SPACING BETWEEN CHANNELS					
Tx Channels	Maximum FDUC NCO clock rate $\times 0.8^1$			1200	MHz
Rx Channels	Maximum FDDC NCO clock rate $\times 0.814^2$			1221	MHz

<sup>1</sup> The 0.8 factor is because the total complex pass band of the first interpolation filter is 80% of the input data rate of the filter.

<sup>2</sup> The 0.814 factor is because the total complex pass band of the decimation filter is 81.4% of the output data rate of the filter.

**JESD204B AND JESD204C INTERFACE ELECTRICAL AND SPEED SPECIFICATIONS**

Nominal supplies. For the minimum and maximum values,  $T_J = -40^{\circ}\text{C}$  to  $+120^{\circ}\text{C}$  and  $\pm 5\%$  of nominal supply, and for the typical values,  $T_A = 25^{\circ}\text{C}$ , unless otherwise noted.

**Table 11. Serial Interface Rate Specifications**

Parameter	Test Conditions/Comments	Min	Typ	Max	Unit
JESD204B SERIAL INTERFACE RATE	Serial lane rate	1.0		15.5	Gbps
Unit Interval		64.5		1000.0	ps
JESD204C SERIAL INTERFACE RATE	Serial lane rate	6.0		24.75	Gbps
Unit Interval		40.4		166.67	ps

**Table 12. JESD204 Receiver (JR<sub>x</sub>) Electrical Specifications**

Parameter	Test Conditions/Comments	Min	Typ	Max	Unit
JESD204 DATA INPUTS	SERDIN <sub>x±</sub> , where x = 0 to 7				
Standards Compliance			JESD204B and JESD204C		
Differential Voltage, $R_{VDIFF}$			800		mV p-p
Differential Impedance, $Z_{RDIFF}$	At dc		98		$\Omega$
Termination Voltage, $V_{TT}$	AC-coupled		0.97		V
SYNC <sub>x</sub> OUTB <sub>±</sub> OUTPUTS <sup>1</sup>	Where x = 0 or 1				
Output Differential Voltage, $V_{OD}$	Driving 100 $\Omega$ differential load		400		mV
Output Offset Voltage, $V_{OS}$			DVDD1P8/2 + 0.2		V
SYNC <sub>x</sub> OUTB+ AND SYNC <sub>x</sub> OUTB-	CMOS output option	Refer to the CMOS Pin Specifications section			

<sup>1</sup> IEEE 1596.3 Standard LVDS compatible.

**Table 13. JESD204 Transmitter (JT<sub>x</sub>) Electrical Specifications**

Parameter	Test Conditions/Comments	Min	Typ	Max	Unit
JESD204 DATA OUTPUTS	SERDOUT <sub>x±</sub> , where x = 0 to 7				
Standards Compliance			JESD204B and JESD204C		
Differential Output Voltage	Maximum strength		675		mV p-p
Differential Termination Impedance		80	108	120	$\Omega$
Rise Time, $t_R$	20% to 80% into 100 $\Omega$ load		18		ps
Fall Time, $t_F$	20% to 80% into 100 $\Omega$ load		18		ps
SYNC <sub>x</sub> INB <sub>±</sub> INPUTS <sup>1</sup>	Where x = 0 or 1				
Logic Compliance			LVDS		
Differential Input Voltage		0.24	0.7	1.9	V p-p
Input Common-Mode Voltage	DC-coupled		0.675	2	V
$R_{IN}$ (Differential)			18		k $\Omega$
Input Capacitance (Differential)			1		pF
SYNC <sub>x</sub> INB+ AND SYNC <sub>x</sub> INB-	CMOS input option	Refer to the CMOS Pin Specifications section			

<sup>1</sup> IEEE 1596.3 Standard low voltage differential signaling (LVDS) compatible.

**Table 14. SYSREF Electrical Specifications**

Parameter	Test Conditions/Comments	Min	Typ	Max	Unit
SYSREFP AND SYSREFN INPUTS					
Logic Compliance			LVDS/LVPECL <sup>1</sup>		
Differential Input Voltage			0.7	1.9	V p-p
Input Common-Mode Voltage Range	DC-coupled		0.675	2	V
Input Reference, $R_{IN}$ (Differential)			100		$\Omega$
Input Capacitance (Differential)			1		pF

<sup>1</sup> LVPECL means low voltage positive/pseudo emitter-coupled logic.

**CMOS PIN SPECIFICATIONS**

For the minimum and maximum values,  $T_j = -40^\circ\text{C}$  to  $+120^\circ\text{C}$ ,  $1.7\text{ V} \leq \text{DVDD1P8} \leq 2.1\text{ V}$ , other supplies nominal, unless otherwise noted.

**Table 15.**

Parameter	Symbol	Test Conditions/Comments	Min	Typ	Max	Unit
INPUTS		SDIO, SCLK, CSB, RESETB, RXEN0, RXEN1, TXEN0, TXEN1, SYNC0INB $\pm$ , SYNC1INB $\pm$ , and GPIOx				
Logic 1 Voltage	$V_{IH}$		$0.70 \times \text{DVDD1P8}$			V
Logic 0 Voltage	$V_{IL}$				$0.3 \times \text{DVDD1P8}$	V
Input Resistance			40			k $\Omega$
OUTPUTS		SDIO, SDO, GPIOx, ADCx_FDX, ADCx_SMONx, SYNC0OUTB $\pm$ , and SYNC1OUTB $\pm$ , 4 mA load				
Logic 1 Voltage	$V_{OH}$		$\text{DVDD1P8} - 0.45$			V
Logic 0 Voltage	$V_{OL}$				0.45	V
INTERRUPT OUTPUTS		IRQB_0 and IRQB_1, pull-up resistor of 5 k $\Omega$ to DVDD1P8				
Logic 1 Voltage	$V_{OH}$		1.35			V
Logic 0 Voltage	$V_{OL}$				0.48	V

**DAC AC SPECIFICATIONS**

Nominal supplies with  $T_A = 25^\circ\text{C}$ .  $f_{IQ\_DATA} = 1500\text{ MSPS}$ . Specifications represent the average of all four DAC channels with the DAC  $I_{OUTFS} = 26\text{ mA}$ , unless otherwise noted.

**Table 16.**

Parameter	Test Conditions/Comments	Min	Typ	Max	Unit
SPURIOUS-FREE DYNAMIC RANGE (SFDR)					
Single-Tone, $f_{DAC} = 12\text{ GSPS}$	-7 dBFS digital backoff, shuffle enabled, 15C mode				
Output Frequency ( $f_{OUT}$ ) = 70 MHz		63	80		dBc
$f_{OUT} = 100\text{ MHz}$			77		dBc
$f_{OUT} = 500\text{ MHz}$			76		dBc
$f_{OUT} = 900\text{ MHz}$			77		dBc
$f_{OUT} = 1900\text{ MHz}$		61	79		dBc
$f_{OUT} = 2600\text{ MHz}$			75		dBc
$f_{OUT} = 3700\text{ MHz}$			69		dBc
$f_{OUT} = 4500\text{ MHz}$			68		dBc
Single-Tone, $f_{DAC} = 9\text{ GSPS}$	-7 dBFS digital backoff, shuffle enabled, 15C mode				
$f_{OUT} = 100\text{ MHz}$			78		dBc
$f_{OUT} = 500\text{ MHz}$			78		dBc
$f_{OUT} = 900\text{ MHz}$			77		dBc
$f_{OUT} = 1900\text{ MHz}$			80		dBc
$f_{OUT} = 2600\text{ MHz}$			80		dBc
$f_{OUT} = 3700\text{ MHz}$			72		dBc
Single-Tone, $f_{DAC} = 6\text{ GSPS}$	-7 dBFS digital backoff, shuffle enabled, 15C mode				
$f_{OUT} = 100\text{ MHz}$			84		dBc
$f_{OUT} = 500\text{ MHz}$			81		dBc
$f_{OUT} = 900\text{ MHz}$			82		dBc
$f_{OUT} = 1900\text{ MHz}$			81		dBc

Parameter	Test Conditions/Comments	Min	Typ	Max	Unit
ADJACENT CHANNEL LEAKAGE RATIO					
Single Carrier 20 MHz LTE Downlink Test Vector $f_{DAC} = 12$ GSPS	-1 dBFS digital backoff, 256QAM $f_{OUT} = 1840$ MHz		77		dBc
	$f_{OUT} = 2650$ MHz		76		dBc
	$f_{OUT} = 3500$ MHz		73		dBc
$f_{DAC} = 9$ GSPS	$f_{OUT} = 1900$ MHz		77		dBc
	$f_{OUT} = 2650$ MHz		77		dBc
$f_{DAC} = 6$ GSPS	$f_{OUT} = 750$ MHz		79		dBc
	$f_{OUT} = 1840$ MHz		77		dBc
THIRD-ORDER INTERMODULATION DISTORTION (IMD3)	Two-tone test, 1 MHz spacing, 0 dBFS digital backoff, -6 dBFS per tone				
$f_{DAC} = 12$ GSPS	$f_{OUT} = 1900$ MHz	-69		-62	dBc
	$f_{OUT} = 2600$ MHz	-72			dBc
	$f_{OUT} = 3700$ MHz	-72			dBc
$f_{DAC} = 9$ GSPS	$f_{OUT} = 1900$ MHz	-79			dBc
	$f_{OUT} = 2600$ MHz	-76			dBc
$f_{DAC} = 6$ GSPS	$f_{OUT} = 900$ MHz	-79			dBc
	$f_{OUT} = 1900$ MHz	-90			dBc
NOISE SPECTRAL DENSITY (NSD)	0 dBFS, NSD measurement taken at 10% away from $f_{OUT}$ , shuffle off				
Single-Tone, $f_{DAC} = 12$ GSPS					
$f_{OUT} = 150$ MHz		-168			dBc/Hz
$f_{OUT} = 500$ MHz		-167			dBc/Hz
$f_{OUT} = 950$ MHz		-165			dBc/Hz
$f_{OUT} = 1840$ MHz		-162			dBc/Hz
$f_{OUT} = 2650$ MHz		-160			dBc/Hz
$f_{OUT} = 3700$ MHz		-155			dBc/Hz
$f_{OUT} = 4500$ MHz		-154			dBc/Hz
Single-Tone, $f_{DAC} = 9$ GSPS					
$f_{OUT} = 150$ MHz		-168			dBc/Hz
$f_{OUT} = 500$ MHz		-166			dBc/Hz
$f_{OUT} = 950$ MHz		-164			dBc/Hz
$f_{OUT} = 1840$ MHz		-160			dBc/Hz
$f_{OUT} = 2650$ MHz		-158			dBc/Hz
$f_{OUT} = 3700$ MHz		-154			dBc/Hz
Single-Tone, $f_{DAC} = 6$ GSPS					
$f_{OUT} = 150$ MHz		-168			dBc/Hz
$f_{OUT} = 500$ MHz		-165			dBc/Hz
$f_{OUT} = 950$ MHz		-163			dBc/Hz
$f_{OUT} = 1840$ MHz		-159			dBc/Hz
$f_{OUT} = 2650$ MHz		-157			dBc/Hz
SINGLE SIDEBAND PHASE NOISE OFFSET (PLL DISABLED)	Direct RF clock input at 7 dBm R&S SMA100B B711 option				
$f_{OUT} = 3$ GHz, $f_{DAC} = 12$ GSPS, CLKINx Frequency ( $f_{CLKIN}$ ) = 12 GHz					
1 kHz		-118			dBc/Hz
10 kHz		-129			dBc/Hz
100 kHz		-137			dBc/Hz
600 kHz		-144			dBc/Hz
1.2 MHz		-148			dBc/Hz
1.8 MHz		-149			dBc/Hz
6 MHz		-153			dBc/Hz

Parameter	Test Conditions/Comments	Min	Typ	Max	Unit
SINGLE SIDEBAND PHASE NOISE OFFSET (PLL ENABLED)	Loop filter component values include C1 = 22 nF, R1 = 226 $\Omega$ , C2 = 2.2 nF, C3 = 33 nF, and phase detector frequency (PFD) = 500 MHz <sup>1</sup>				
$f_{OUT} = 1.8$ GHz, $f_{DAC} = 12$ GSPS, $f_{CLKIN} = 0.5$ GHz					
1 kHz			-106		dBc/Hz
10 kHz			-113		dBc/Hz
100 kHz			-120		dBc/Hz
600 kHz			-127		dBc/Hz
1.2 MHz			-134		dBc/Hz
1.8 MHz			-138		dBc/Hz
6 MHz		-150		dBc/Hz	

<sup>1</sup> Refer to the [UG-1578](#) user guide for details on the loop filter components.

**ADC AC SPECIFICATIONS**

Nominal supplies with  $T_A = 25^\circ\text{C}$ . Input amplitude ( $A_{IN}$ ) =  $-1$  dBFS, full bandwidth (no decimation). For the minimum and maximum values,  $T_J = -40^\circ\text{C}$  to  $+120^\circ\text{C}$ . Specifications represent the average of two ADC channels with DACs powered on. See the AN-835 Application Note, *Understanding High Speed ADC Testing and Evaluation*, for definitions and for details on how these tests were completed.

**Table 17.**

Parameter	Min	Typ	Max	Unit
NOISE DENSITY <sup>1</sup>		-153		dBFS/Hz
NOISE FIGURE <sup>2</sup>		25.3		dB
CODE ERROR RATE (CER)		$1.6 \times 10^{-20}$		Errors
SIGNAL-TO-NOISE RATIO (SNR)				
$f_{IN} = 450$ MHz		56.9		dBFS
$f_{IN} = 900$ MHz		56.7		dBFS
$f_{IN} = 1800$ MHz		54.9		dBFS
$f_{IN} = 2700$ MHz	49.6	52.7		dBFS
$f_{IN} = 3600$ MHz		52.1		dBFS
$f_{IN} = 4500$ MHz		50.7		dBFS
$f_{IN} = 5400$ MHz		50.8		dBFS
$f_{IN} = 6300$ MHz		49.7		dBFS
$f_{IN} = 7200$ MHz		48.8		dBFS
SIGNAL-TO-NOISE-AND-DISTORTION (SINAD)				
$f_{IN} = 450$ MHz		56.9		dBFS
$f_{IN} = 900$ MHz		56.5		dBFS
$f_{IN} = 1800$ MHz		54.5		dBFS
$f_{IN} = 2700$ MHz	49.5	52.5		dBFS
$f_{IN} = 3600$ MHz		51.2		dBFS
$f_{IN} = 4500$ MHz		50.2		dBFS
$f_{IN} = 5400$ MHz		49.0		dBFS
$f_{IN} = 6300$ MHz		48.0		dBFS
$f_{IN} = 7200$ MHz		47.4		dBFS
EFFECTIVE NUMBER OF BITS (ENOB)				
$f_{IN} = 450$ MHz		9.2		Bits
$f_{IN} = 900$ MHz		9.1		Bits
$f_{IN} = 1800$ MHz		8.8		Bits
$f_{IN} = 2700$ MHz	7.9	8.4		Bits
$f_{IN} = 3600$ MHz		8.2		Bits
$f_{IN} = 4500$ MHz		8.05		Bits
$f_{IN} = 5400$ MHz		7.8		Bits
$f_{IN} = 6300$ MHz		7.7		Bits
$f_{IN} = 7200$ MHz		7.6		Bits
SECOND-ORDER HARMONIC DISTORTION (HD2)				
$f_{IN} = 450$ MHz		-78		dBFS
$f_{IN} = 900$ MHz		-74		dBFS
$f_{IN} = 1800$ MHz		-71		dBFS
$f_{IN} = 2700$ MHz		-72	-57	dBFS
$f_{IN} = 3600$ MHz		-60		dBFS
$f_{IN} = 4500$ MHz		-62		dBFS
$f_{IN} = 5400$ MHz		-55		dBFS
$f_{IN} = 6300$ MHz		-54		dBFS
$f_{IN} = 7200$ MHz		-54		dBFS

Parameter	Min	Typ	Max	Unit
THIRD-ORDER HARMONIC DISTORTION (HD3)				
$f_{IN} = 450$ MHz		-84		dBFS
$f_{IN} = 900$ MHz		-83		dBFS
$f_{IN} = 1800$ MHz		-66		dBFS
$f_{IN} = 2700$ MHz		-68	-62	dBFS
$f_{IN} = 3600$ MHz		-70		dBFS
$f_{IN} = 4500$ MHz		-67		dBFS
$f_{IN} = 5400$ MHz		-63		dBFS
$f_{IN} = 6300$ MHz		-65		dBFS
$f_{IN} = 7200$ MHz		-62		dBFS
WORST OTHER, EXCLUDING HD2 OR HD3 HARMONIC				
$f_{IN} = 450$ MHz		-90		dBFS
$f_{IN} = 900$ MHz		-91		dBFS
$f_{IN} = 1800$ MHz		-86		dBFS
$f_{IN} = 2700$ MHz		-83	-61	dBFS
$f_{IN} = 3600$ MHz		-81		dBFS
$f_{IN} = 4500$ MHz		-78		dBFS
$f_{IN} = 5400$ MHz		-78		dBFS
$f_{IN} = 6300$ MHz		-76		dBFS
$f_{IN} = 7200$ MHz		-75		dBFS
DIGITAL COUPLING SPUR ( $f_{IN} \pm f_s/4$ )				
$f_{IN} = 450$ MHz		-92		dBFS
$f_{IN} = 900$ MHz		-88		dBFS
$f_{IN} = 1800$ MHz		-81		dBFS
$f_{IN} = 2700$ MHz		-81		dBFS
$f_{IN} = 3600$ MHz		-78		dBFS
$f_{IN} = 4500$ MHz		-74		dBFS
$f_{IN} = 5400$ MHz		-76		dBFS
$f_{IN} = 6300$ MHz		-71		dBFS
$f_{IN} = 7200$ MHz		-70		dBFS
TWO-TONE IMD3, INPUT AMPLITUDE 1 ( $A_{IN1}$ ) = INPUT AMPLITUDE 2 ( $A_{IN2}$ ) = -7 dBFS				
Input Frequency 1 ( $f_{IN1}$ ) = 1775 MHz, Input Frequency 2 ( $f_{IN2}$ ) = 1825 MHz		-84		dBFS
$f_{IN1} = 2675$ MHz, $f_{IN2} = 2725$ MHz		-86		dBFS
$f_{IN1} = 3575$ MHz, $f_{IN2} = 3625$ MHz		-75		dBFS
$f_{IN1} = 5375$ MHz, $f_{IN2} = 5425$ MHz		-67		dBFS
ANALOG BANDWIDTH <sup>3</sup>		8		GHz

<sup>1</sup> Noise density is measured at a low analog amplitude and/or frequency where timing jitter does not degrade noise floor.

<sup>2</sup> Noise figure is based on a nominal full-scale input power of 4.5 dBm with an input span of 1.475 V p-p and  $R_{IN} = 100 \Omega$ .

<sup>3</sup> Analog input bandwidth is the bandwidth of operation in which the full-scale input frequency response rolls off by -3 dB based on a de-embedded model of the ADC extracted from the measured frequency response on evaluation board. This bandwidth requires optimized matching network to achieve this upper bandwidth.

**TIMING SPECIFICATIONS**

For the minimum and maximum values,  $T_j = -40^{\circ}\text{C}$  to  $+120^{\circ}\text{C}$  and  $\pm 5\%$  of nominal supply, unless otherwise noted.

Table 18.

Parameter	Symbol	Test Conditions/Comments	Min	Typ	Max	Unit
<b>SERIAL PORT INTERFACE (SPI) WRITE OPERATION</b>						
Maximum SCLK Clock Rate	$f_{\text{SCLK}}, 1/t_{\text{SCLK}}$		33			MHz
SCLK Clock High	$t_{\text{PWH}}$	SCLK = 33 MHz	8			ns
SCLK Clock Low	$t_{\text{PWL}}$	SCLK = 33 MHz	8			ns
SDIO to SCLK Setup Time	$t_{\text{DS}}$		4			ns
SCLK to SDIO Hold Time	$t_{\text{DH}}$		4			ns
CSB to SCLK Setup Time	$t_{\text{S}}$		4			ns
SCLK to CSB Hold Time	$t_{\text{H}}$		4			ps
<b>SPI READ OPERATION</b>						
<b>LSB First Data Format</b>						
Maximum SCLK Clock Rate	$f_{\text{SCLK}}, 1/t_{\text{SCLK}}$		33			MHz
SCLK Clock High	$t_{\text{PWH}}$		8			ns
SCLK Clock Low	$t_{\text{PWL}}$		8			ns
<b>MSB First Data Format</b>						
Maximum SCLK Clock Rate	$f_{\text{SCLK}}, 1/t_{\text{SCLK}}$		15			MHz
SCLK Clock High	$t_{\text{PWH}}$		30			ns
SCLK Clock Low	$t_{\text{PWL}}$		30			ns
SDIO to SCLK Setup Time	$t_{\text{DS}}$		4			ns
SCLK to SDIO Hold Time	$t_{\text{DH}}$		4			ns
CSB to SCLK Setup Time	$t_{\text{S}}$		4			ns
SCLK to SDIO Data Valid Time	$t_{\text{DV}}$		20			ns
SCLK to SDO Data Valid Time	$t_{\text{DV\_SDO}}$		20			ns
CSB to SDIO Output Valid to High-Z	$t_{\text{Z}}$		20			ns
CSB to SDO Output Valid to High-Z	$t_{\text{Z\_SDO}}$		20			ns

**Timing Diagrams**

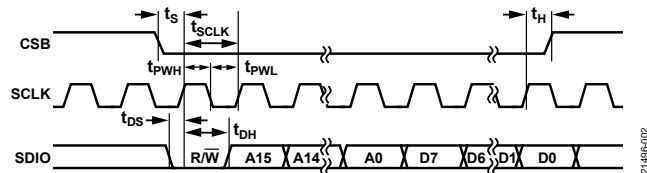

Figure 2. Timing Diagram for 3-Wire Write Operation

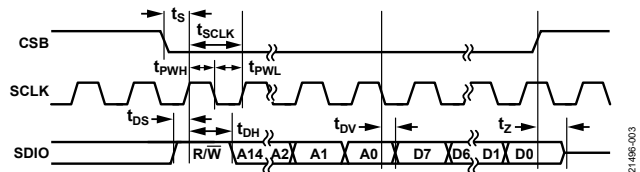

Figure 3. Timing Diagram for 3-Wire Read Operation

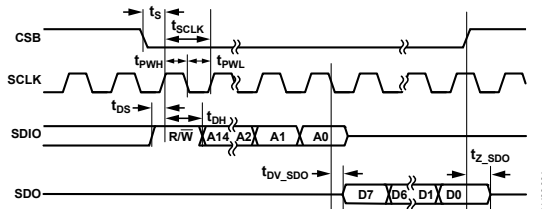

Figure 4. Timing Diagram for 4-Wire Read Operation

## ABSOLUTE MAXIMUM RATINGS

Table 19.

Parameter	Rating
ISET, DACxP, DACxN, TDP, TDN	-0.3 V to AVDD2 + 0.3 V
VCO_COARSE, VCO_FINE, VCO_VCM, VCO_VREG	-0.3 V to AVDD2_PLL + 0.3 V
Rx Input Power (ADC0P, ADC0N, ADC1P, ADC1N) <sup>1</sup>	22 dBm
VCM0, VCM1	-0.3 V to RVDD2 + 0.3 V
CLKINP, CLKINN	-0.2 V to PLLCLKVDD1 + 0.2 V
ADCDRVN, ADCDRVP	-0.2 V to CLKVDD1 + 0.2 V
SERDINx±, SERDOUTx±	-0.2 V to SVDD1 + 0.2 V
SYSREFP, SYSREFN, and SYNCxINB±	-0.2 V to +2.5 V
SYNCxOUTB±, SYNCxINB±, RESETB, TXENx, RXENx, IRQB_x, CSB, SCLK, SDIO, SDO, TMU_REFN, TMU_REFP, ADCx_SMON0, ADCx_SMON1, ADCx_FD0, ADCx_FD1, GPIOx	-0.3 V to DVDD1P8 + 0.3 V
AVDD2, AVDD2_PLL, BVDD2, RVDD2, SVDD2_PLL, DVDD1P8	-0.3 V to +2.2 V
PLLCLKVDD1, AVDD1, AVDD1_ADC, CLKVDD1, FVDD1, DAVDD1, DVDD1_RT, DCLKVDD1, SVDD1	-0.2 V to +1.2 V
VNN1	-1.1 V to +0.2 V
Temperature	
Junction (T <sub>J</sub> ) <sup>2</sup>	120°C
Storage Range	-65°C to +150°C

<sup>1</sup> Tested continuously for 1000 hours with  $f_{IN} = 4.7$  GHz pulsed and continuous tone at maximum allowed T<sub>J</sub>. Refer to the [UG-1578](#) user guide, for more information.

<sup>2</sup> Do not exceed this temperature for any duration of time when the device is powered.

Stresses at or above those listed under Absolute Maximum Ratings may cause permanent damage to the product. This is a stress rating only; functional operation of the product at these or any other conditions above those indicated in the operational section of this specification is not implied. Operation beyond the maximum operating conditions for extended periods may affect product reliability.

### THERMAL RESISTANCE

Thermal performance is directly linked to PCB design and operating environment. The use of appropriate thermal management techniques is recommended to ensure that the maximum T<sub>J</sub> does not exceed the limits shown in Table 19.

θ<sub>JA</sub> is the natural convection, junction to ambient thermal resistance measured in a one cubic foot sealed enclosure.

θ<sub>JC\_TOP</sub> is the junction to case, thermal resistance.

θ<sub>JB</sub> is the junction to board, thermal resistance.

Table 20. Simulated Thermal Resistance<sup>1</sup>

PCB Type	Airflow Velocity (m/sec)	θ <sub>JA</sub>	θ <sub>JC_TOP</sub>	θ <sub>JB</sub>	Unit
JEDEC 2s2p Board	0.0	14.9	0.70	1.8	°C/W

<sup>1</sup> Thermal resistance values specified are simulated based on JEDEC specifications in compliance with JESD51-12 with the device power equal to 9 W.

### ESD CAUTION



**ESD (electrostatic discharge) sensitive device.** Charged devices and circuit boards can discharge without detection. Although this product features patented or proprietary protection circuitry, damage may occur on devices subjected to high energy ESD. Therefore, proper ESD precautions should be taken to avoid performance degradation or loss of functionality.

# PIN CONFIGURATION AND FUNCTION DESCRIPTIONS

AD9082  
TOP VIEW  
(Not to Scale)

	1	2	3	4	5	6	7	8	9	10	11	12	13	14	15	16	17	18
A	GND	AVDD2	GND	GND	NC	NC	GND	GND	ADC0N	ADC0P	GND	SYNC1IN-	SYNC0IN-	SERDOUT0-	SERDOUT0+	SVDD1	GND	GND
B	DAC0P	GND	GND	GND	GND	GND	DNC	VCM0	GND	GND	RVDD2	SYNC1IN+	SYNC0IN+	GND	GND	SVDD1	SERDOUT7-	SERDOUT7+
C	DAC0N	GND	ADCDRVN	ADCDRVP	GND	GND	GND	GND	BVNN2	BVDD3	GND	RESETB	DVDD1P8	SERDOUT1-	SERDOUT1+	SVDD1	GND	GND
D	GND	AVDD1	AVDD1	AVDD1	GND	FVDD1	BVDD2	VNN1	GND	VDD1_NVG	ADC0_SMON1	ADC0_SMON0	RXEN1	GND	GND	SVDD1	SERDOUT6-	SERDOUT6+
E	GND	AVDD2	AVDD1	GND	DAVDD1	GND	BVDD2	VNN1	NVG1_OUT	VNN1	ADC0_FD1	ADC0_FD0	RXEN0	SERDOUT2-	SERDOUT2+	SVDD1	GND	GND
F	DAC1N	GND	AVDD1	GND	DAVDD1	GND	GND	GND	DVDD1P8	DVDD1	ADC1_SMON1	ADC1_SMON0	SDIO	GND	GND	SVDD1	SERDOUT5-	SERDOUT5+
G	DAC1P	GND	GND	GND	GND	CLKVDD1	AVDD1_ADC	AVDD1_ADC	TMU_REFN	TMU_REFP	ADC1_FD1	ADC1_FD0	CSB	SERDOUT3-	SERDOUT3+	SVDD1	GND	GND
H	GND	AVDD2	ISET	DNC	GND	GND	GND	GND	DVDD1	GND	DVDD1	GND	SCLK	GND	GND	SVDD1	SERDOUT4-	SERDOUT4+
J	CLKINP	GND	VCO_FINE	VCO_COARSE	PLCLKVDD1	DVDD1_RT	DVDD1_RT	GND	DVDD1	GND	DVDD1	GND	SDO	GND	GND	SVDD1_PLL	GND	GND
K	CLKINN	GND	VCO_VREG	VCO_VCM	DCLKVDD1	DVDD1_RT	DVDD1_RT	GND	DVDD1	GND	DVDD1	GND	GPIO9	GND	SVDD2_PLL	SVDD1_PLL	GND	GND
L	GND	AVDD2	AVDD2_PLL	DNC	GND	GND	GND	GND	DVDD1	GND	DVDD1	GND	GPIO8	GND	DNC	DNC	SERDIN0-	SERDIN0+
M	DAC2P	GND	GND	GND	GND	CLKVDD1	AVDD1_ADC	AVDD1_ADC	DVDD1	GND	GPIO3	GPIO1	GPIO7	SERDIN4-	SERDIN4+	SVDD1	GND	GND
N	DAC2N	GND	AVDD1	GND	DAVDD1	GND	GND	GND	TDP	TDN	GPIO2	GPIO0	GPIO6	GND	GND	SVDD1	SERDIN1-	SERDIN1+
P	GND	AVDD2	AVDD1	GND	DAVDD1	GND	BVDD2	VNN1	NVG1_OUT	VNN1	GPIO4	IRQB_0	TXEN0	SERDIN7-	SERDIN7+	SVDD1	GND	GND
R	GND	AVDD1	AVDD1	AVDD1	GND	FVDD1	BVDD2	VNN1	GND	VDD1_NVG	GPIO5	IRQB_1	TXEN1	GND	GND	SVDD1	SERDIN2-	SERDIN2+
T	DAC3N	GND	SYSREFN	SYSREFP	GND	GND	GND	GND	BVNN2	BVDD3	GND	GPIO10	DVDD1P8	SERDIN6-	SERDIN6+	SVDD1	GND	GND
U	DAC3P	GND	GND	GND	GND	GND	DNC	VCM1	GND	GND	RVDD2	SYNC1OUTB+	SYNC0OUTB+	GND	GND	SVDD1	SERDIN3-	SERDIN3+
V	GND	AVDD2	GND	GND	NC	NC	GND	GND	ADC1N	ADC1P	GND	SYNC1OUTB-	SYNC0OUTB-	SERDIN5-	SERDIN5+	SVDD1	GND	GND



Figure 5. 324-Ball Pin Configuration

21495-008

Table 21. Pin Function Descriptions

Pin No.	Mnemonic	Type	Description
<b>POWER SUPPLIES</b>			
A2, E2, H2, L2, P2, V2	AVDD2	Input	Analog 2.0 V Supply Inputs for DAC.
L3	AVDD2_PLL	Input	Analog 2.0 V Supply Input for Clock PLL Linear Dropout Regulator (LDO).
D7, E7, P7, R7	BVDD2	Input	Analog 2.0 V Supply Inputs for ADC Buffer.
B11, U11	RVDD2	Input	Analog 2.0 V Supply Inputs for ADC Reference.
J5	PLLCLKVDD1	Input	Analog 1.0 V Supply Input for Clock PLL.
D2 to D4, E3, F3, N3, P3, R2 to R4	AVDD1	Input	Analog 1.0 V Supply Inputs for DAC Clock.
G7, G8, M7, M8	AVDD1_ADC	Input	Analog 1.0 V Supply Inputs for ADC.
G6, M6	CLKVDD1	Input	Analog 1.0 V Supply Inputs for ADC Clock.
D6, R6	FVDD1	Input	Analog 1.0 V Supply Inputs for ADC Reference.
D10, R10	VDD1_NVG	Input	Analog 1.0 V Supply Inputs for Negative Voltage Generator (NVG) Used to Generate -1 V Output.
E9, P9	NVG1_OUT	Output	Analog -1 V Supply Outputs from NVG. Decouple NVG1_OUT to GND with a 0.1 $\mu$ F capacitor.
D8, E8, E10, P8, R8, P10	VNN1	Input	Analog -1 V Supply Inputs for ADC Buffer and Reference. Connect these pins to the adjacent, NVG1_OUT pins.
C9, T9,	BVNN2	Output	Analog -2 V Supply Outputs for ADC Buffer. Decouple each BVNN2 pin to GND with a 0.1 $\mu$ F capacitor.
C10, T10	BVDD3	Output	Analog 3 V Supply Output for ADC Buffer. Decouple BVDD3 to GND with 0.1 $\mu$ F capacitor.
E5, F5, N5, P5	DAVDD1	Input	Digital Analog 1.0 V Supply Inputs.
F10, H9, H11, J9, J11, K9, K11, L9, L11, M9	DVDD1	Input	Digital 1.0 V Supply Inputs.
J6, J7, K6, K7	DVDD1_RT	Input	Digital 1.0 Supply Inputs for Retimer Block.
K5	DCLKVDD1	Input	Digital 1.0 V Clock Generation Supply.
A16, B16, C16, D16, E16, F16, G16, H16, M16, N16, P16, R16, T16, U16, V16	SVDD1	Input	Digital 1.0 V Supply Inputs for SERDES Deserializer and Serializer.
K15	SVDD2_PLL	Input	Digital 2.0 V Supply Input for SERDES LDO.
J16, K16	SVDD1_PLL	Input	Digital 1.0 V Supply Inputs for SERDES Clock Generation and PLL.
C13, F9, T13	DVDD1P8	Input	Digital Interface and Temperature Monitoring Unit (TMU) Supply Inputs (Nominal 1.8 V).
A1, A3, A4, A7, A8, A11, A17, A18, B2 to B6, B9, B10, B14, B15, C2, C5 to C8, C11, C17, C18, D1, D5, D9, D14, D15, E1, E4, E6, E17, E18, F2, F4, F6 to F8, F14, F15, G2 to G5, G17, G18, H1, H5 to H8, H10, H12, H14, H15, J2, J8, J10, J12, J14, J15, J17, J18, K2, K8, K10, K12, K14, K17, K18, L1, L5 to L8, L10, L12, L14, M2 to M5, M10, M17, M18, N2, N4, N6 to N8, N14, N15, P1, P4, P6, P17, P18, R1, R5, R9, R14, R15, T2, T5 to T8, T11, T17, T18, U2 to U6, U9, U10, U14, U15, V1, V3, V4, V7, V8, V11, V17, V18	GND	Input/output	Ground References.

Pin No.	Mnemonic	Type	Description
<b>ANALOG OUTPUTS</b>			
B1, C1	DAC0P, DAC0N	Output	DAC0 Output Currents, Ground Referenced. Tie these pins to GND if unused.
G1, F1	DAC1P, DAC1N	Output	DAC1 Output Currents, Ground Referenced. Tie these pins to GND if unused. These pins are unused for the AD9082BBPZ-2D2AC.
M1, N1	DAC2P, DAC2N	Output	DAC2 Output Currents, Ground Referenced. Tie these pins to GND if unused.
U1, T1	DAC3P, DAC3N	Output	DAC3 Output Currents, Ground Referenced. Tie these pins to GND if unused. These pins are unused for the AD9082BBPZ-2D2AC.
H3	ISET	Output	DAC Bias Current Setting Pin. Connect this pin with a 5 k $\Omega$ resistor to GND.
C4, C3	ADCDRVP, ADCDRVN	Output	ADC Clock Output Options. These pins are disabled by default.
B8, U8	VCM0, VCM1	Output	ADC Buffer Common-Mode Output Voltage. Decouple this pin to GND with a 0.1 $\mu$ F capacitor.
K3	VCO_VREG	Output	PLL LDO Regulator Output. Decouple this pin to GND with a 2.2 $\mu$ F capacitor.
G9	TMU_REFN	Output	TMU ADC Negative Reference. Connect this pin to GND.
G10	TMU_REFP	Output	TMU ADC Positive Reference. Connect this pin to DVDD1P8.
<b>ANALOG INPUTS</b>			
A10, A9	ADC0P, ADC0N	Input	ADC0 Differential Inputs with Internal 100 $\Omega$ Differential Resistor.
V10, V9	ADC1P, ADC1N	Input	ADC1 Differential Inputs with Internal 100 $\Omega$ Differential Resistor.
J3	VCO_FINE	Input	On-Chip Clock Multiplier and PLL Fine Loop Filter Input.
J4	VCO_COARSE	Input	On-Chip DAC Clock Multiplier and PLL Coarse Loop Filter Input.
K4	VCO_VCM	Input	On-Chip Clock Multiplier and VCO Common-Mode Input.
N9, N10	TDP, TDN	Input	Anode and Cathode of Temperature Diodes. This feature is not supported. Tie TDP and TDN to GND.
J1, K1	CLKINP, CLKINN	Input	Differential Clock Inputs with Nominal 100 $\Omega$ Termination. Self bias input requiring ac coupling. When the on-chip clock multiplier PLL is enabled, this input is the reference clock input. If the PLL is disabled, an RF clock equal to the DAC output sample rate is required.
<b>CMOS INPUTS AND OUTPUTS<sup>1</sup></b>			
G13	CSB	Input	Serial Port Enable Input. Active low.
H13	SCLK	Input	Serial Plot Clock Input.
F13	SDIO	Input/output	Serial Port Bidirectional Data Input/Output.
J13	SDO	Output	Serial Port Data Output.
C12	RESETB	Input	Active Low Reset Input. RESETB places digital logic and SPI registers in a known default state. RESETB must be connected to a digital IC that is capable of issuing a reset signal for the first step in the device initialization process.
E13, D13	RXEN0, RXEN1	Input	Active High ADC and Receive Datapath Enable Inputs. RXENx is also SPI configurable.
P13, R13	TXEN0, TXEN1	Input	Active High DAC and Transmit Datapath Enable Inputs. TXENx is also SPI configurable.

Pin No.	Mnemonic	Type	Description
D12, D11	ADC0_SMON0, ADC0_SMON1	Output	ADC0 Signal Monitoring Outputs by Default. Do not connect if unused.
F12, F11	ADC1_SMON0, ADC1_SMON1	Output	ADC1 Signal Monitoring Outputs by Default. Do not connect if unused.
E12, E11	ADC0_FD0, ADC0_FD1	Output	ADC0 Fast Detect Outputs by Default. Do not connect if unused.
G12, G11	ADC1_FD0, ADC1_FD1	Output	ADC1 Fast Detect Outputs by Default. Do not connect if unused.
P12, R12	IRQB_0, IRQB_1	Outputs	Interrupt Request 0 and 1 Outputs. These pins are an open-drain, active low output (CMOS levels with respect to DVDD1P8). Connect a 10 k $\Omega$ pull-up resistor to DVDD1P8 to prevent these pins from floating when unused.
M11, M12, N11, N12, P11, R11	GPIO0 to GPIO5	Input/output	General-Purpose Input or Output Pins. These pins control auxiliary functions related to the Tx datapaths.
K13, L13, M13, N13, T12	GPIO6 to GPIO10	Input/output	General-Purpose Input or Output Pins. These pins control auxiliary functions related to the Rx datapaths and ADCs.
JESD204B or JESD204C COMPATIBLE SERDES DATA LANES AND CONTROL SIGNALS <sup>2</sup>			
L18, L17	SERDIN0+, SERDIN0-	Input	JRx Lane 0 Inputs, Data True/Complement.
N18, N17	SERDIN1+, SERDIN1-	Input	JRx Lane 1 Inputs, Data True/Complement.
R18, R17	SERDIN2+, SERDIN2-	Input	JRx Lane 2 Inputs, Data True/Complement.
U18, U17	SERDIN3+, SERDIN3-	Input	JRx Lane 3 Inputs, Data True/Complement.
M15, M14	SERDIN4+, SERDIN4-	Input	JRx Lane 4 Inputs, Data True/Complement.
V15, V14	SERDIN5+, SERDIN5-	Input	JRx Lane 5 Inputs, Data True/Complement.
T15, T14	SERDIN6+, SERDIN6-	Input	JRx Lane 6 Inputs, Data True/Complement.
P15, P14	SERDIN7+, SERDIN7-	Input	JRx Lane 7 Inputs, Data True/Complement.
U13, V13	SYNC0OUTB+, SYNC0OUTB-	Output	JRx Link 0 Synchronization Outputs for JESD204B interface. These pins are LVDS or CMOS configurable. These pins can also provide differential 100 $\Omega$ output impedance in LVDS mode.
U12, V12	SYNC1OUTB+, SYNC1OUTB-	Output	JRx Link 1 Synchronization Outputs for JESD204B interface or CMOS Input for Transmit Fast Frequency Hopping (FFH) via GPIOx pins. For sync output function, these pins are LVDS or CMOS output configurable and can provide differential 100 $\Omega$ output impedance in LVDS mode.
A15, A14	SERDOUT0+, SERDOUT0-	Output	JTx Lane 0 Outputs, Data True/Complement.
C15, C14	SERDOUT1+, SERDOUT1-	Output	JTx Lane 1 Outputs, Data True/Complement.
E15, E14	SERDOUT2+, SERDOUT2-	Output	JTx Lane 2 Outputs, Data True/Complement.
G15, G14	SERDOUT3+, SERDOUT3-	Output	JTx Lane 3 Outputs, Data True/Complement.
H18, H17	SERDOUT4+, SERDOUT4-	Output	JTx Lane 4 Outputs, Data True/Complement.

Pin No.	Mnemonic	Type	Description
F18, F17	SERDOUT5+, SERDOUT5–	Output	JTx Lane 5 Outputs, Data True/Complement.
D18, D17	SERDOUT6+, SERDOUT6–	Output	JTx Lane 6 Outputs, Data True/Complement.
B18, B17	SERDOUT7+, SERDOUT7–	Output	JTx Lane 7 Outputs, Data True/Complement.
B13, A13	SYNC0INB+, SYNC0INB–	Input	JTx Link 0 Synchronization Inputs for JESD204B interface. These pins are LVDS or CMOS configurable. These pins are LVDS or CMOS configurable and have selectable internal 100 $\Omega$ input impedance for LVDS operation
B12, A12	SYNC1INB+, SYNC1INB–	Input	JTx Link 1 Synchronization Inputs for JESD204B interface or CMOS Inputs for Receive FFH via GPIOx pins. These pins are LVDS or CMOS configurable and have selectable internal 100 $\Omega$ input impedance for LVDS operation.
T4, T3	SYSREFP, SYSREFN	Input	Active High JESD204 System Reference Inputs. These pins are configurable for differential current mode logic (CML), PECL, and LVDS with internal 100 $\Omega$ termination or single-ended CMOS.
NO CONNECTS AND DO NOT CONNECTS A5, A6, V5, V6	NC		No Connect. These pins can be left open or connected.
B7, H4, L4, L15, L16, U7	DNC	DNC	Do Not Connect. The pins must be kept open.

<sup>1</sup> CMOS inputs do not have pull-up or pull-down resistors.

<sup>2</sup> SERDINx $\pm$  and SERDOUTx $\pm$  include 100  $\Omega$  internal termination resistors.

# TYPICAL PERFORMANCE CHARACTERISTICS

## DAC

The data curves represent the average performance across all outputs with harmonics and spurs falling in the first Nyquist zone ( $<f_{DAC}/2$ ). All SFDR, IMD3, and NSD data is measured on a laboratory evaluation board. All data for the phase noise and adjacent channel leakage ratio (ACLR) is measured on the [AD9081-FMCA-EBZ](#) or [AD9082-FMCA-EBZ](#) customer evaluation boards. For additional information on the JESD204B and JESD204C mode configurations, see the [UG-1578](#) user guide.

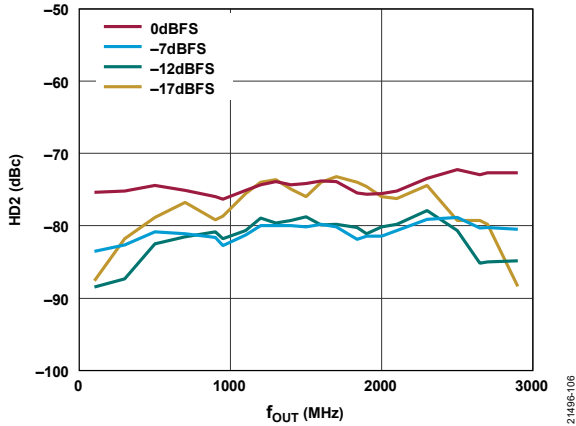

Figure 6. HD2 vs.  $f_{OUT}$  over Digital Scale, 6 GSPS DAC Sample Rate, Channel Interpolation 1x, Main Interpolation 4x, Mode 15C

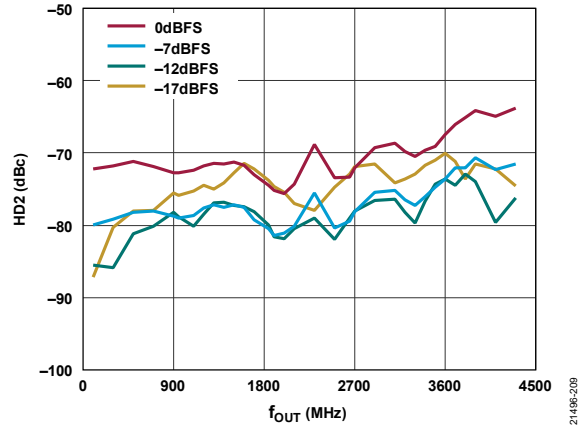

Figure 9. HD2 vs.  $f_{OUT}$  over Digital Scale, 9 GSPS DAC Sample Rate, Channel Interpolation 1x, Main Interpolation 6x, Mode 15C

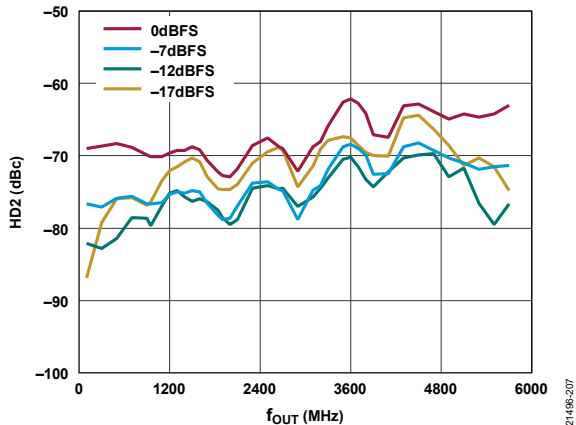

Figure 7. HD2 vs.  $f_{OUT}$  over Digital Scale, 12 GSPS DAC Sample Rate, Channel Interpolation 1x, Main Interpolation 8x, Mode 15C

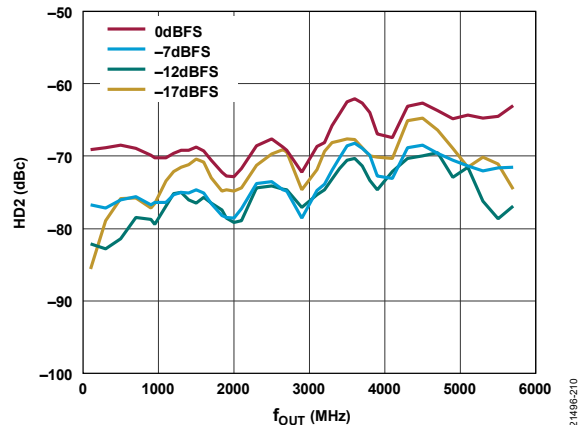

Figure 10. HD2 vs.  $f_{OUT}$  over Digital Scale, 12 GSPS DAC Sample Rate, Channel Interpolation 4x, Main Interpolation 8x, Mode 16B

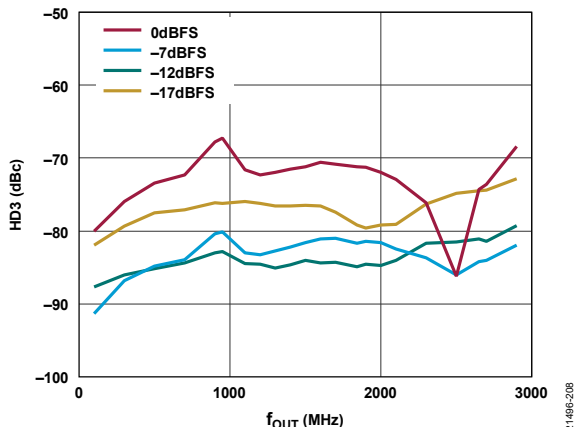

Figure 8. HD3 vs.  $f_{OUT}$  over Digital Scale, 6 GSPS DAC Sample Rate, Channel Interpolation 1x, Main Interpolation 4x, Mode 15C

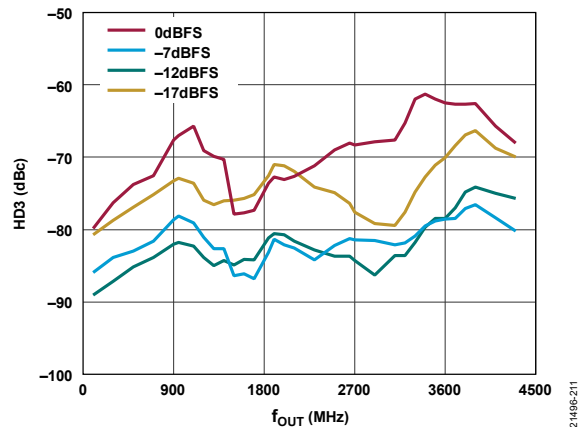

Figure 11. HD3 vs.  $f_{OUT}$  over Digital Scale, 9 GSPS DAC Sample Rate, Channel Interpolation 1x, Main Interpolation 6x, Mode 15C

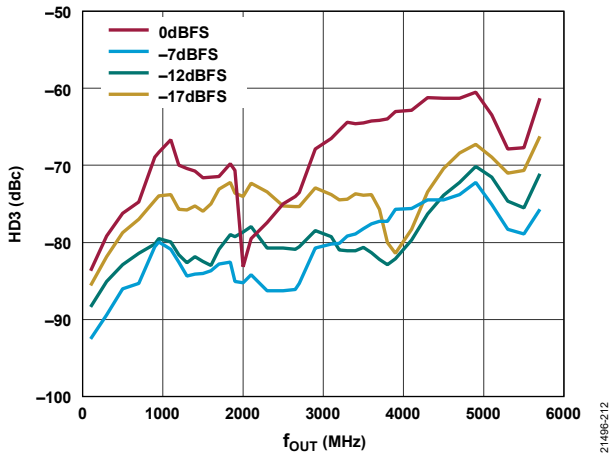

Figure 12. HD3 vs.  $f_{OUT}$  over Digital Scale, 12 GSPS DAC Sample Rate, Channel Interpolation 1x, Main Interpolation 8x, Mode 15C

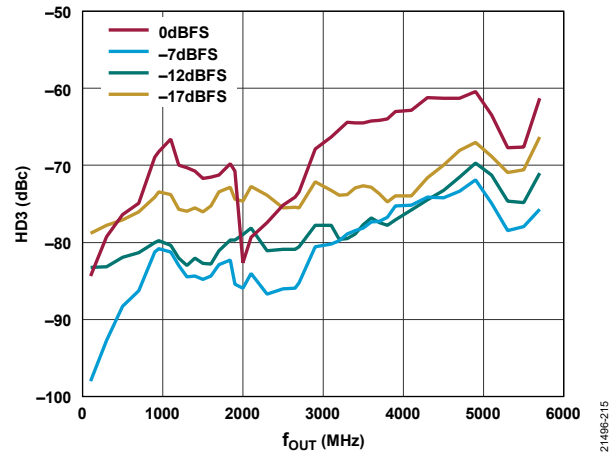

Figure 15. HD3 vs.  $f_{OUT}$  over Digital Scale, 12 GSPS DAC Sample Rate, Channel Interpolation 4x, Main Interpolation 8x, Mode 16B

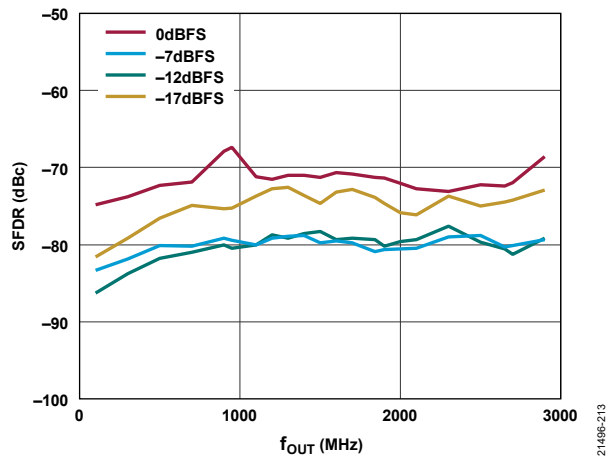

Figure 13. SFDR, Worst Spurious vs.  $f_{OUT}$  over Digital Scale, 6 GSPS DAC Sample Rate, Channel Interpolation 1x, Main Interpolation 4x, Mode 15C

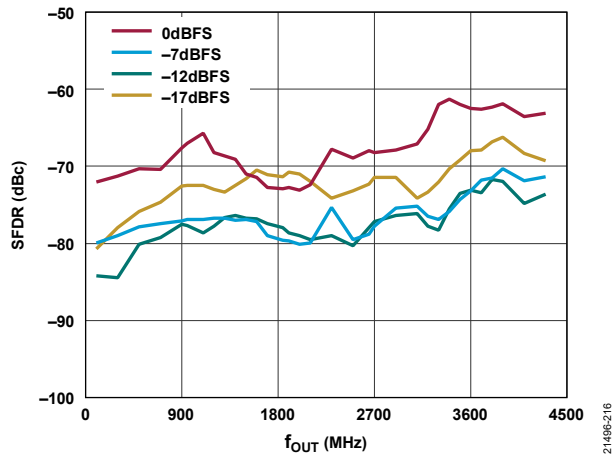

Figure 16. SFDR, Worst Spurious vs.  $f_{OUT}$  over Digital Scale, 9 GSPS DAC Sample Rate, Channel Interpolation 1x, Main Interpolation 6x, Mode 15C

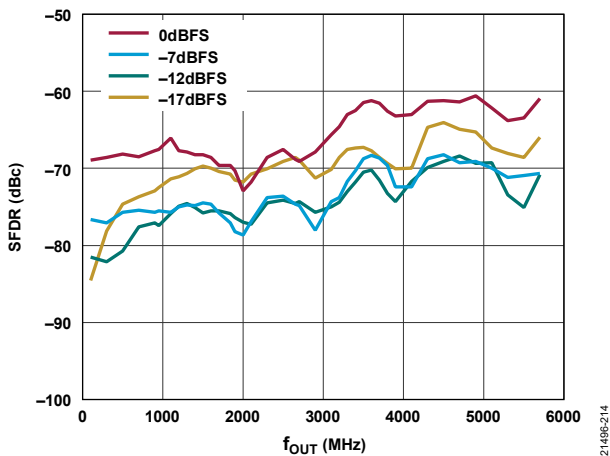

Figure 14. SFDR, Worst Spurious vs.  $f_{OUT}$  over Digital Scale, 12 GSPS DAC Sample Rate, Channel Interpolation 1x, Main Interpolation 8x, Mode 15C

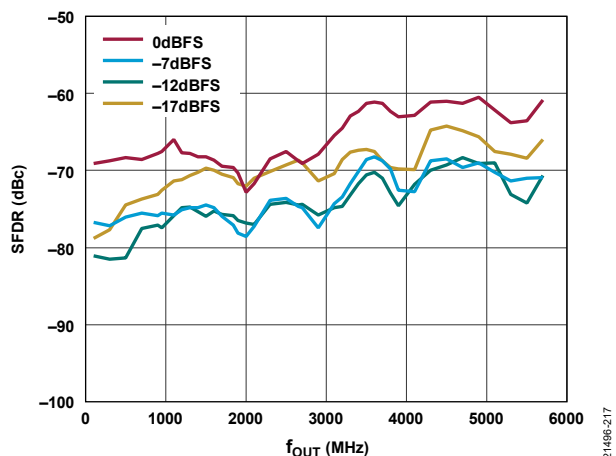

Figure 17. SFDR, Worst Spurious vs.  $f_{OUT}$  over Digital Scale, 12 GSPS DAC Sample Rate, Channel Interpolation 4x, Main Interpolation 8x, Mode 16B

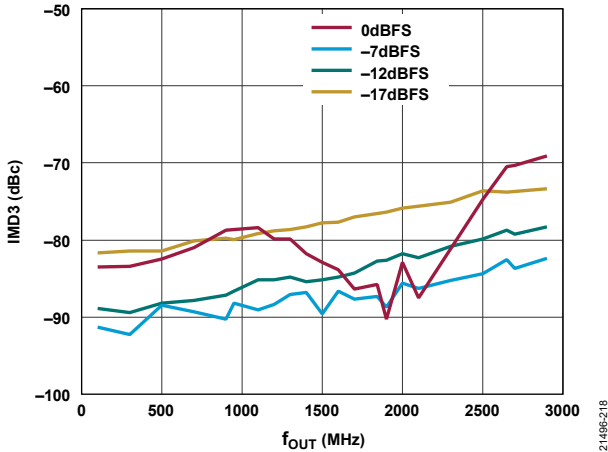

Figure 18. IMD3 vs.  $f_{OUT}$  over Digital Scale (Mode 17B), 6 GSPS DAC Sample Rate, Channel Interpolation 1 $\times$ , Main Interpolation 4 $\times$ , Mode 15C, IMD3 is a Two-Tone Test, and the Scale per Tone is 6 dB Lower than the Reported Digital Scale

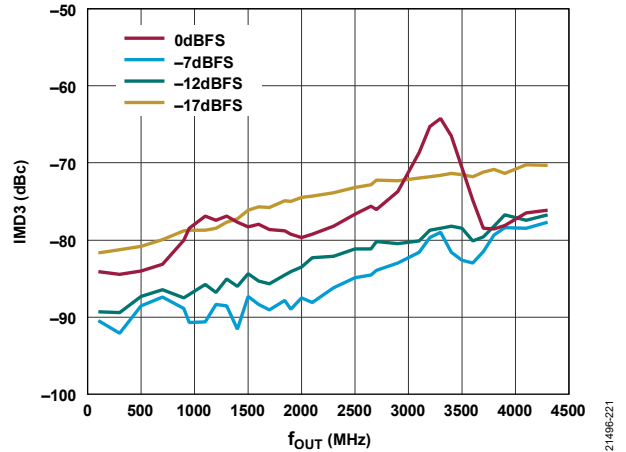

Figure 21. IMD3 vs.  $f_{OUT}$  over Digital Scale, 9 GSPS DAC Sample Rate, Channel Interpolation 1 $\times$ , Main Interpolation 6 $\times$ , Mode 15C, IMD3 is a Two-Tone Test, and the Scale per Tone is 6 dB Lower than the Reported Digital Scale

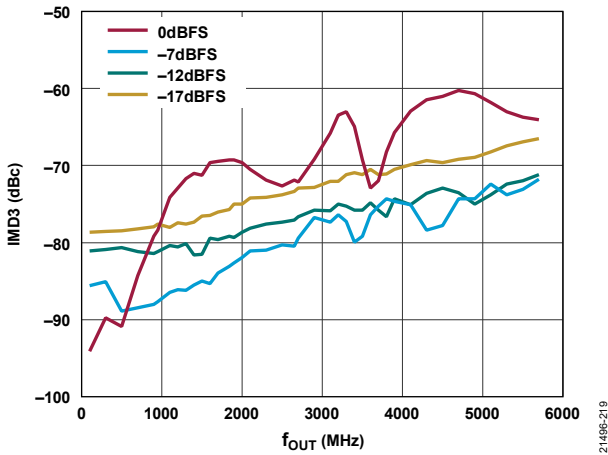

Figure 19. IMD3 vs.  $f_{OUT}$  over Digital Scale, 12 GSPS DAC Sample Rate, Channel Interpolation 1 $\times$ , Main Interpolation 8 $\times$ , Mode 15C, IMD3 is a Two-Tone Test, and the Scale per Tone is 6 dB Lower than the Reported Digital Scale

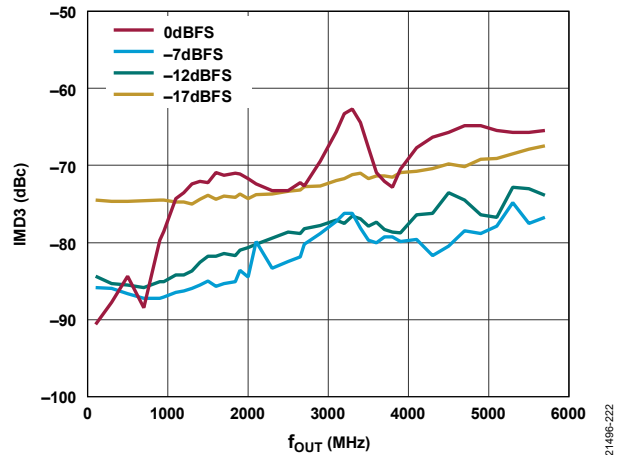

Figure 22. IMD3 vs.  $f_{OUT}$  over Digital Scale, 12 GSPS DAC Sample Rate, Channel Interpolation 4 $\times$ , Main Interpolation 8 $\times$ , Mode 16B, IMD3 is a Two-Tone Test, and the Scale per Tone is 6 dB Lower than the Reported Digital Scale

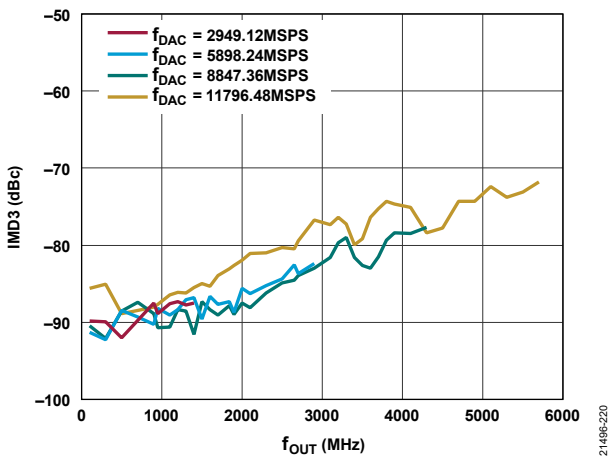

Figure 20. IMD3 vs.  $f_{OUT}$  over  $f_{DAC}$ , Digital Scale -7 dBFS, IMD3 is a Two-Tone Test, and the Scale per Tone is 6 dB Lower than the Reported Digital Scale

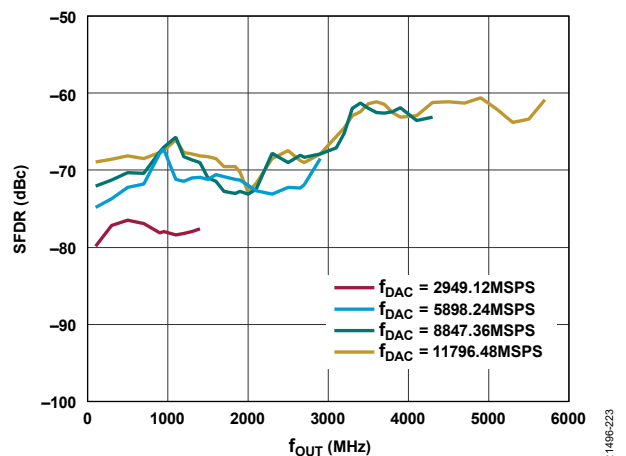

Figure 23. SFDR, Worst In-Band Spurious vs.  $f_{OUT}$  over  $f_{DAC}$  with 0 dBFS Tone Level

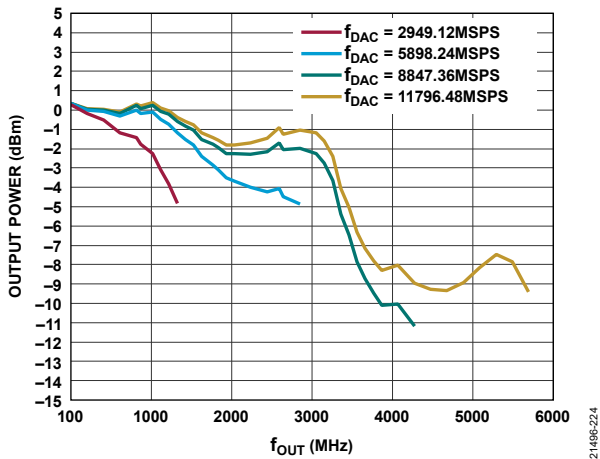

Figure 24. DAC0 Fundamental Output Power vs.  $f_{OUT}$  Across  $f_{DAC}$ , at 0 dBFS Digital Backoff, Measured on a Laboratory Evaluation Board, the AD9081-FMCA-EBZ or AD9082-FMCA-EBZ Evaluation Board has a Different PCB Layout and Results in a Different Frequency Response when Compared to a Laboratory Evaluation Board

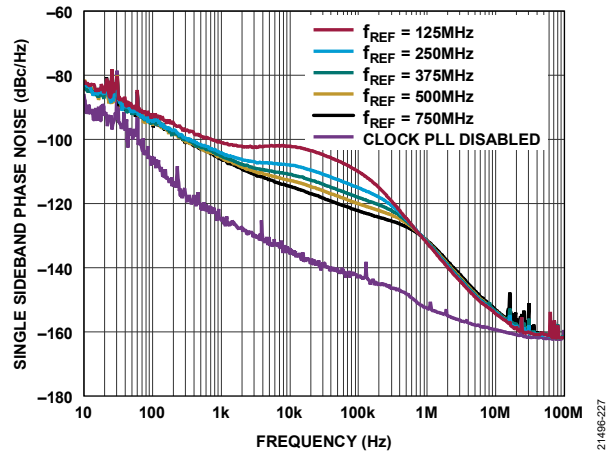

Figure 27. Single Sideband Phase Noise vs. Frequency Offset for Different PLL Reference Clocks ( $f_{REF}$ ),  $f_{OUT} = 1.8$  GHz,  $f_{DAC} = 12$  GSPS, PLL Enabled with Exception of External 12 GHz Clock Input with Clock PLL Disabled

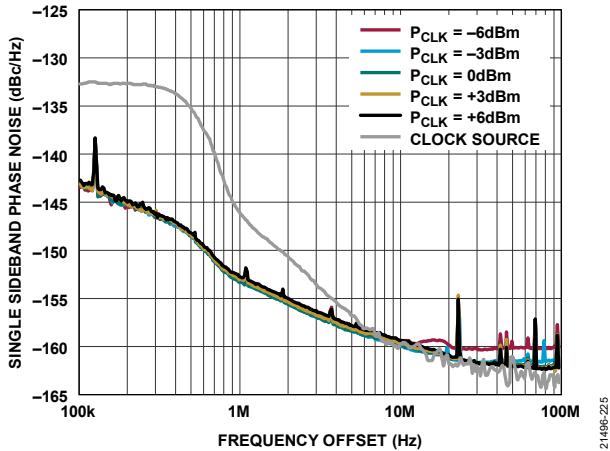

Figure 25. Single Sideband Phase Noise vs. Frequency Offset for Different Clock Input Power ( $P_{CLK}$ ),  $f_{OUT} = 1.8$  GHz, External 12 GHz Clock Input with Clock PLL Disabled

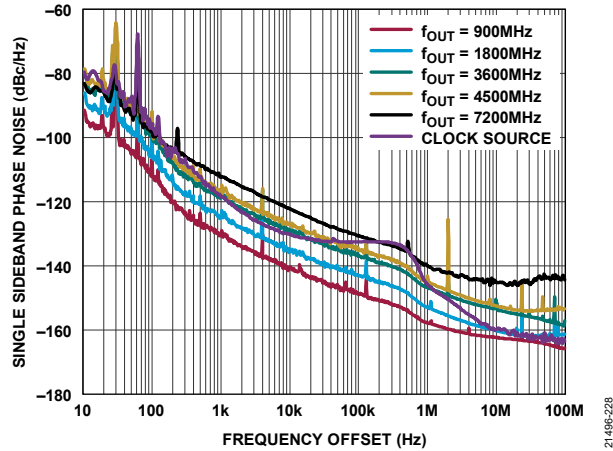

Figure 28. Single Sideband Phase Noise vs. Frequency Offset for Different DAC Output Frequencies ( $f_{OUT}$ ), External 12 GHz Clock Input with Clock PLL Disabled

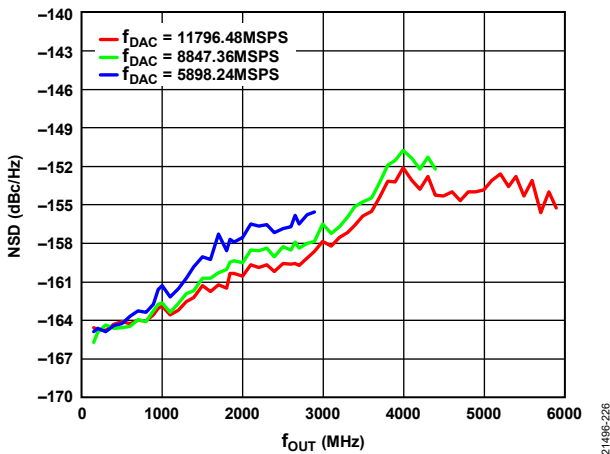

Figure 26. Single-Tone NSD Measured at 10% Offset from  $f_{OUT}$  vs.  $f_{OUT}$  over  $f_{DAC}$ , Shuffle On, 16-Bit Resolution, Mode 15C

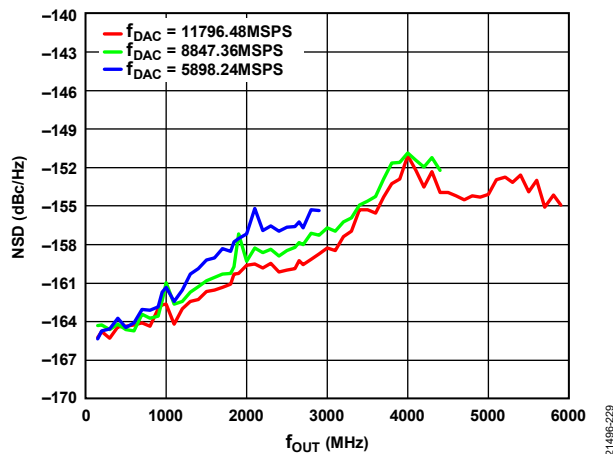

Figure 29. Single-Tone NSD Measured at 10% Offset from  $f_{OUT}$  vs.  $f_{OUT}$  over  $f_{DAC}$ , 12-Bit Resolution, Shuffle On, Mode 24C

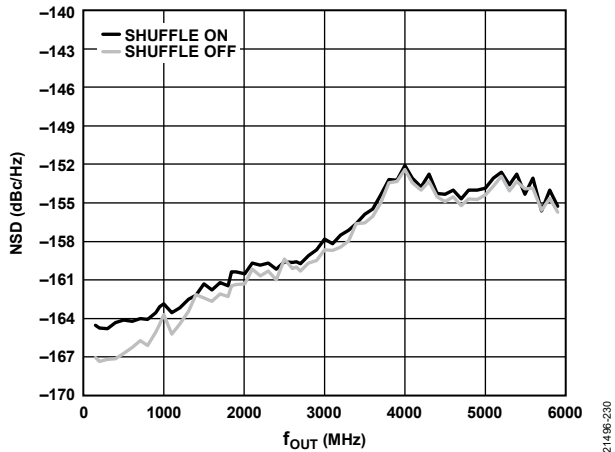

Figure 30. Single-Tone NSD Measured at 10% Offset from  $f_{OUT}$  vs.  $f_{OUT}$ , Shuffle Off vs. Shuffle On,  $f_{DAC} = 11796.48$  MSPS, 16-Bit Resolution, Mode 15C

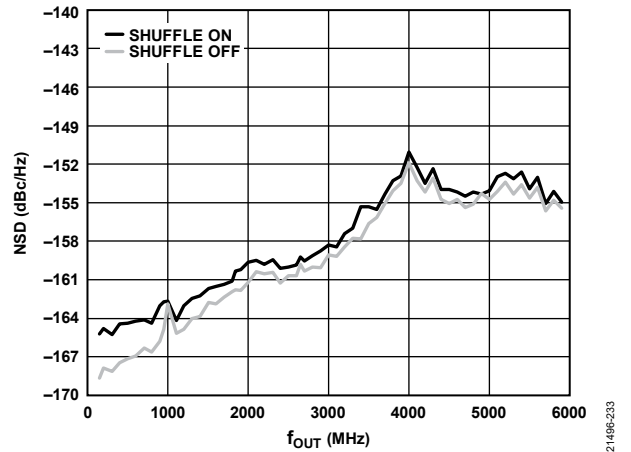

Figure 33. Single-Tone NSD Measured at 10% Offset from  $f_{OUT}$  vs.  $f_{OUT}$ , Shuffle Off vs. Shuffle On,  $f_{DAC} = 11796.48$  MSPS, 12-Bit Resolution, Mode 24C

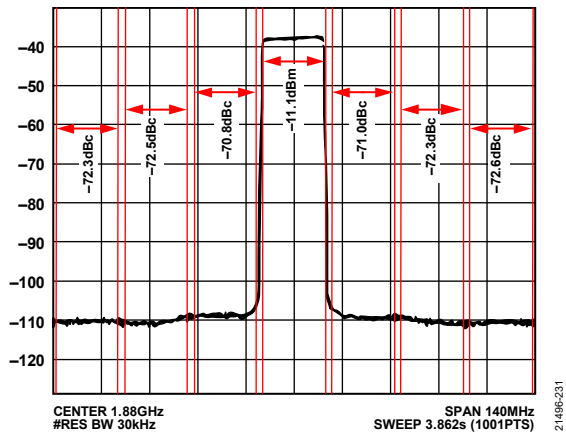

Figure 31. Dual Band ACLR Performance for Two 20 MHz LTE carriers at  $f_{OUT} = 1.88$  GHz and  $f_{OUT} = 2.145$  GHz (Refer to Figure 32 for a Wideband Plot), Showing a Close Up of One Carrier at  $f_{OUT} = 1.88$  GHz,  $f_{DAC} = 11.796$  GSPS, Test Vector PAR = 7.7 dB with -1 dBFS Backoff, Channel Interpolation 3x, Main Interpolation 8x, Mode 9C

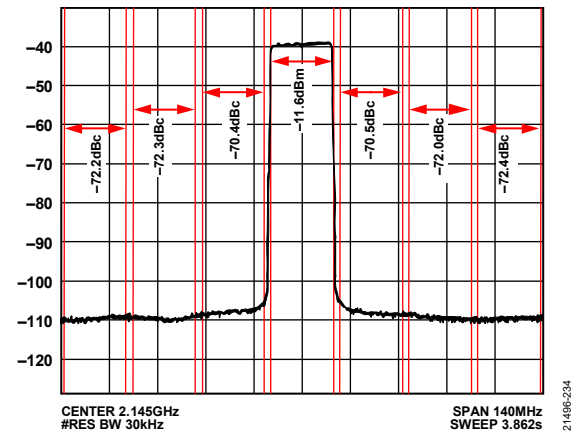

Figure 34. Dual Band ACLR Performance for two 20 MHz LTE carriers at  $f_{OUT} = 1.88$  GHz and  $f_{OUT} = 2.145$  GHz (Refer to Figure 32 for a Wideband Plot), Showing a Close Up of One Carrier at  $f_{OUT} = 2.145$  GHz,  $f_{DAC} = 11.796$  GSPS, Test Vector PAR = 7.7 dB with -1 dBFS Backoff, Channel Interpolation 3x, Main Interpolation 8x, Mode 9C

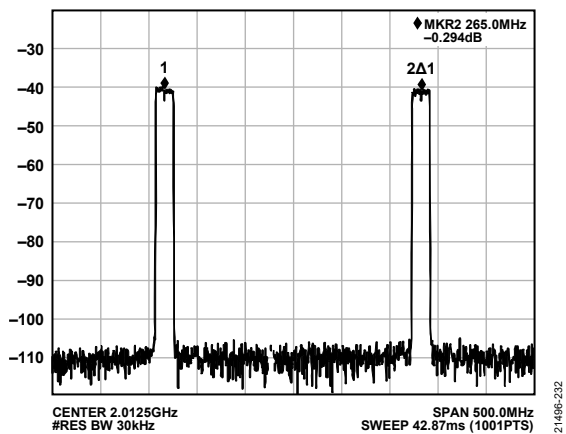

Figure 32. Dual Band Wideband Plot for Two 20 MHz LTE Carriers at  $f_{OUT} = 1.88$  GHz and  $f_{OUT} = 2.145$  GHz (3GPP Bands, B1 and B3, Respectively), at  $f_{DAC} = 11.796$  GSPS, Test Vector PAR = 7.7 dB with -1 dBFS Backoff, Channel Interpolation 3x, Main Interpolation 8x, Mode 9C

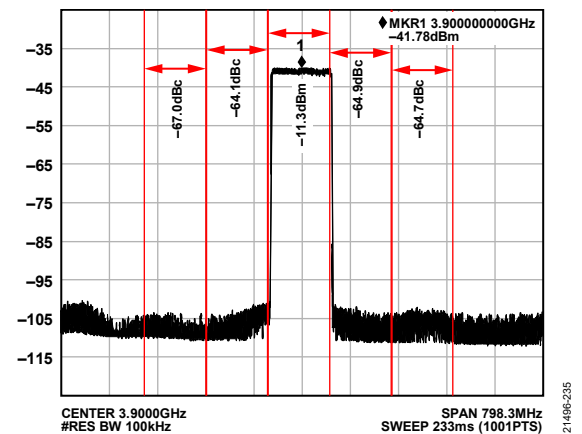

Figure 35. ACLR Performance for 100 MHz 5G Test Vector at  $f_{OUT} = 3.9$  GHz and  $f_{DAC} = 11.898$  GSPS, Test Vector Peak to RMS = 11.7 dB with -1 dBFS Backoff (Mode 9C), Channel Interpolation 3x, Main Interpolation 8x

ADC

Nominal supplies, sampling rate = 6 GSPS with DAC clock frequency ( $f_{CLK}$ ) = 12 GHz direct RF clock, full bandwidth mode operation (no decimation),  $T_j = 80^\circ\text{C}$  ( $T_A = 25^\circ\text{C}$ ), 128k FFT sample with five averages, and  $A_{IN} = -1$  dBFS, unless otherwise noted.

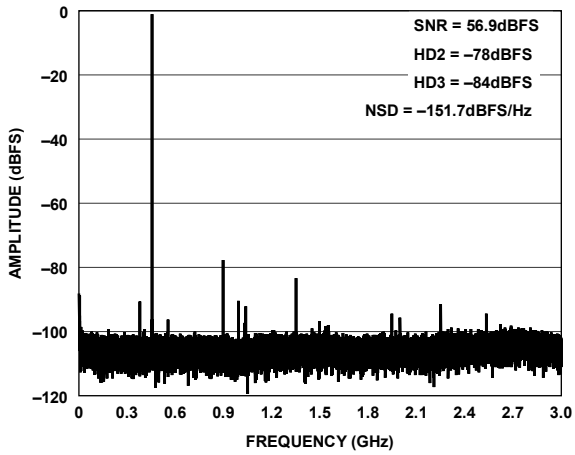

Figure 36. Single-Tone FFT at  $f_{IN} = 450$  MHz

21496-236

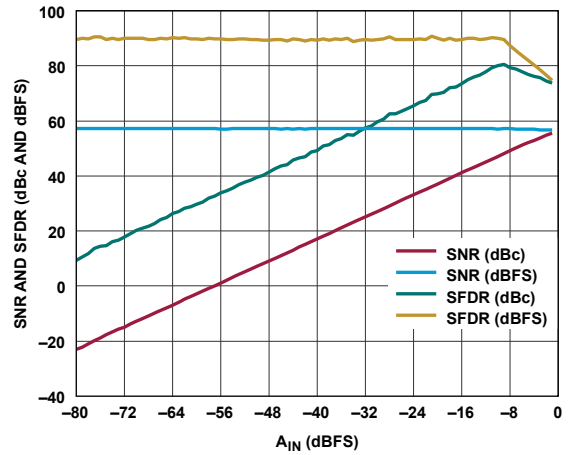

Figure 39. Single-Tone SFDR and SNR vs.  $A_{IN}$  at  $f_{IN} = 450$  MHz

21496-239

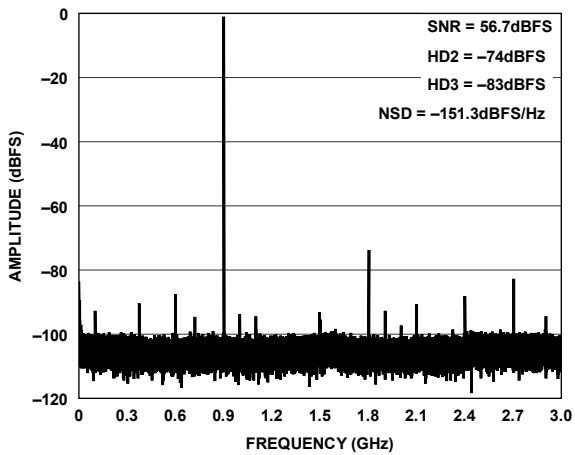

Figure 37. Single-Tone FFT at  $f_{IN} = 900$  MHz

21496-237

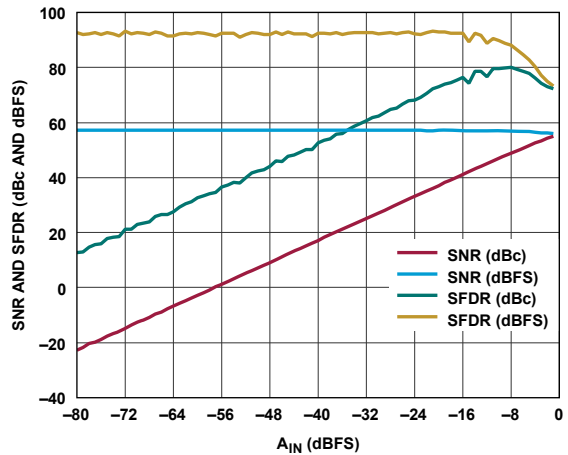

Figure 40. Single-Tone SFDR and SNR vs.  $A_{IN}$  at  $f_{IN} = 900$  MHz

21496-240

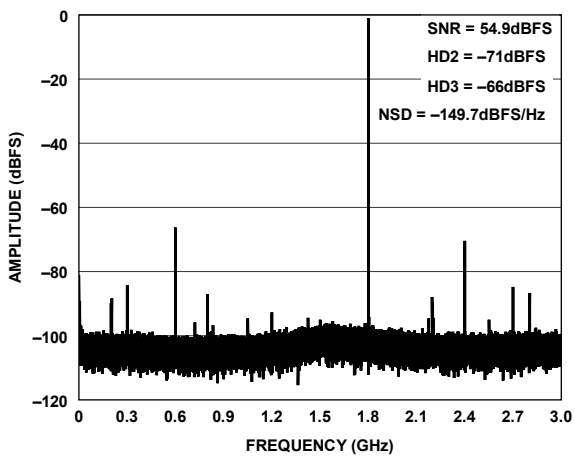

Figure 38. Single-Tone FFT at  $f_{IN} = 1.8$  GHz

21496-238

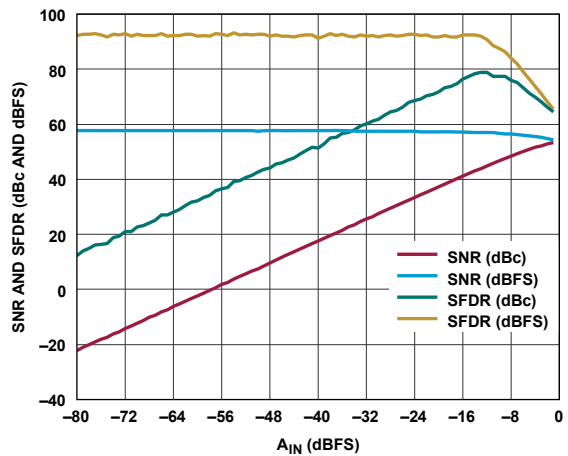

Figure 41. Single-Tone SFDR and SNR vs.  $A_{IN}$  at  $f_{IN} = 1.8$  GHz

21496-241

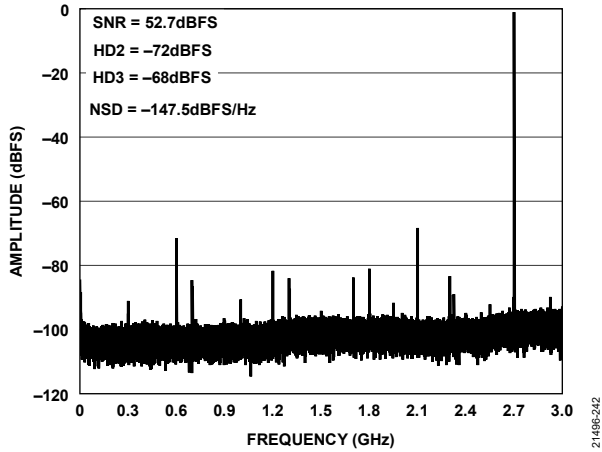

Figure 42. Single-Tone FFT at  $f_{IN} = 2.7$  GHz

21486-242

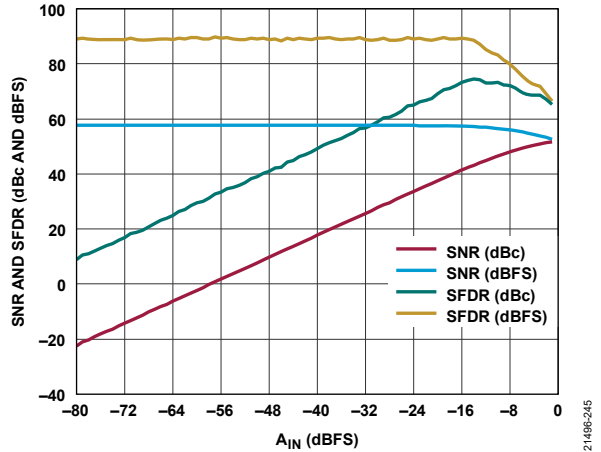

Figure 45. Single-Tone SFDR and SNR vs.  $A_{IN}$  at  $f_{IN} = 2.7$  GHz

21486-245

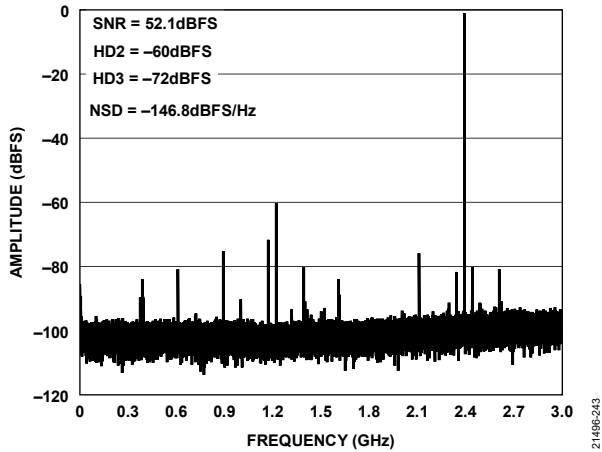

Figure 43. Single-Tone FFT at  $f_{IN} = 3.6$  GHz

21486-243

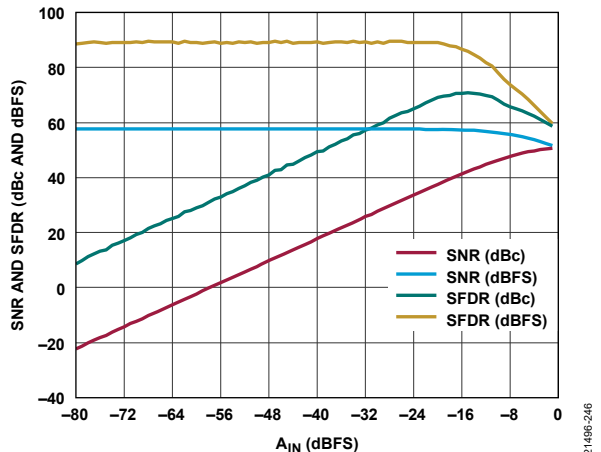

Figure 46. Single-Tone SFDR and SNR vs.  $A_{IN}$  at  $f_{IN} = 3.6$  GHz

21486-246

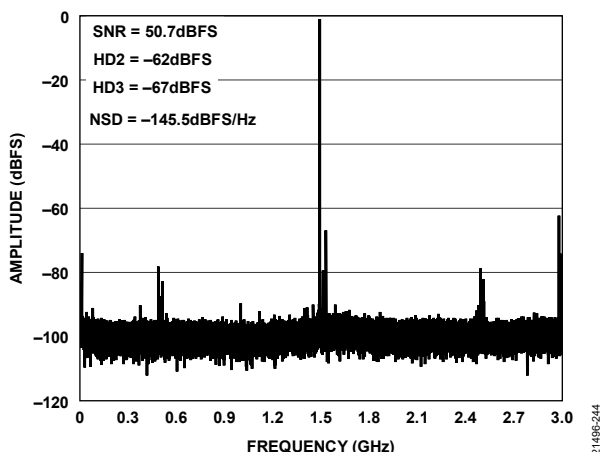

Figure 44. Single-Tone FFT at  $f_{IN} = 4.5$  GHz

21486-244

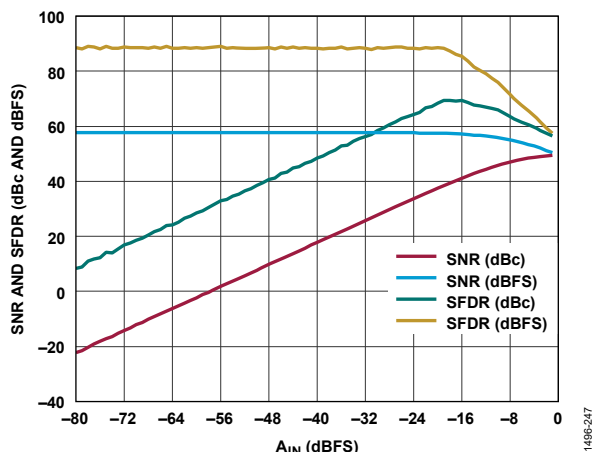

Figure 47. Single-Tone SFDR and SNR vs.  $A_{IN}$  at  $f_{IN} = 4.5$  GHz

21486-247

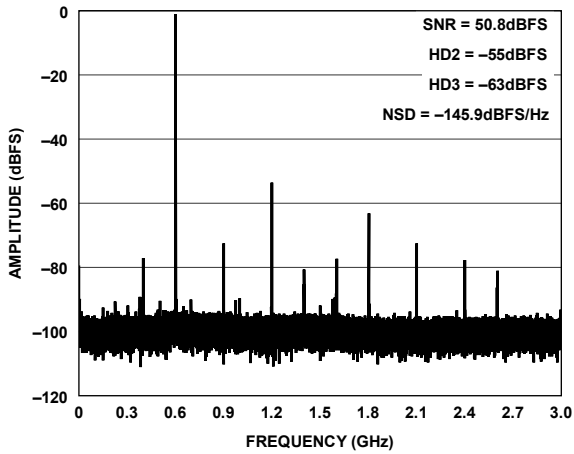

Figure 48. Single-Tone FFT at  $f_{IN} = 5.4$  GHz

21486-248

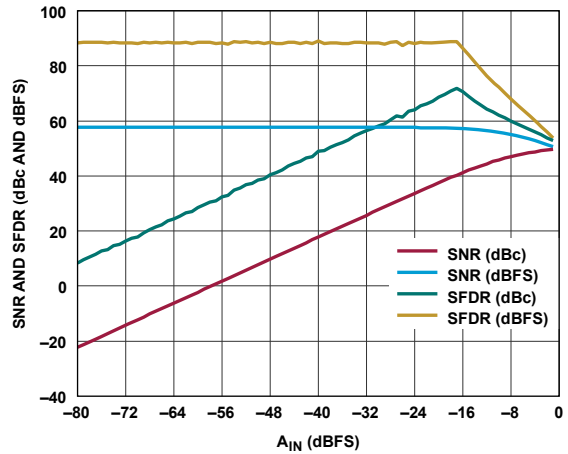

Figure 51. Single-Tone SFDR and SNR vs.  $A_{IN}$  at  $f_{IN} = 5.4$  GHz

21486-251

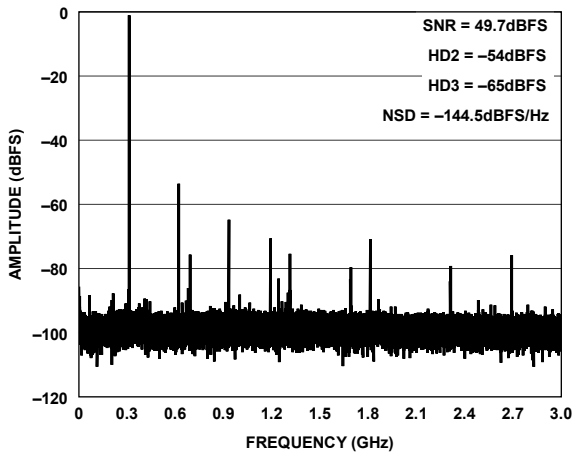

Figure 49. Single-Tone FFT at  $f_{IN} = 6.3$  GHz

21486-249

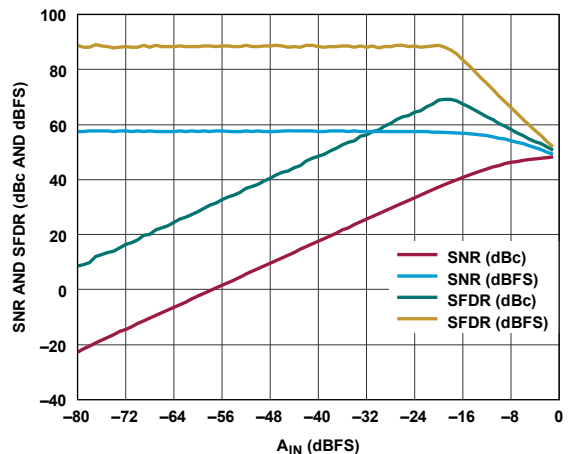

Figure 52. Single-Tone SFDR and SNR vs.  $A_{IN}$  at  $f_{IN} = 6.3$  GHz

21486-252

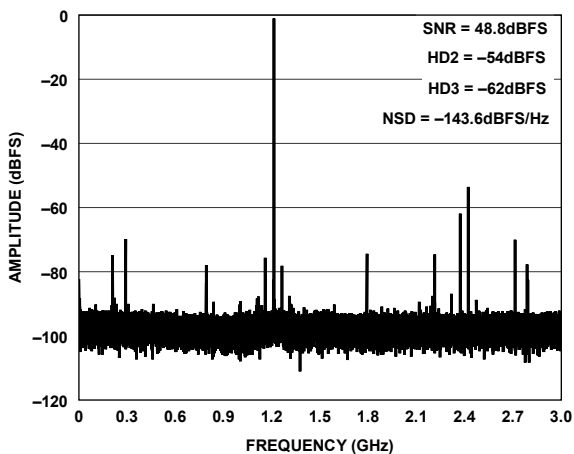

Figure 50. Single-Tone FFT at  $f_{IN} = 7.2$  GHz

21486-250

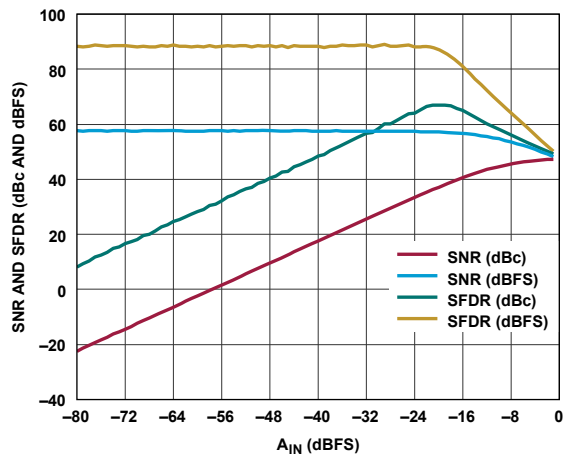

Figure 53. Single-Tone SFDR and SNR vs.  $A_{IN}$  at  $f_{IN} = 7.2$  GHz

21486-253

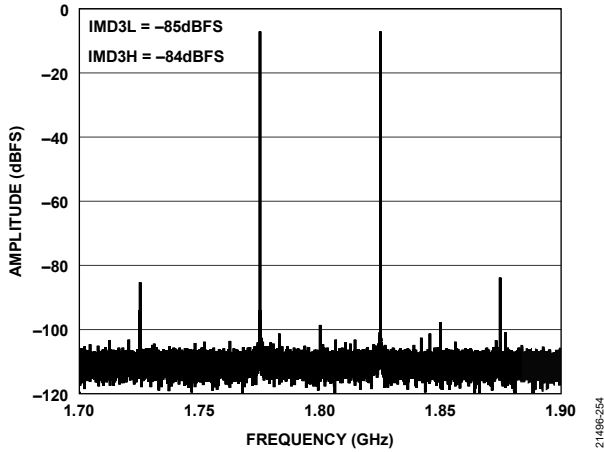

Figure 54. Two-Tone FFT,  $f_{IN1} = 1.775$  GHz,  $f_{IN2} = 1.825$  GHz, and  $A_{IN1}$  and  $A_{IN2} = -7$  dBFS (Note That IMD3L and IMD3H Are the Lower and Higher IMD3 Product Components in dBFS)

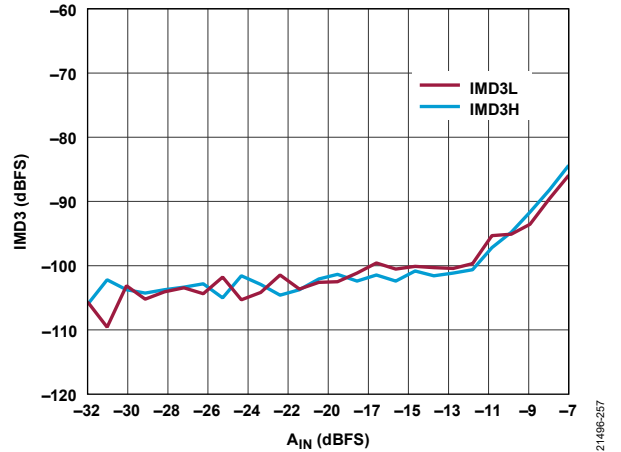

Figure 57. Two-Tone IMD3 vs.  $A_{IN}$  with  $f_{IN1} = 1.775$  GHz,  $f_{IN2} = 1.825$  GHz

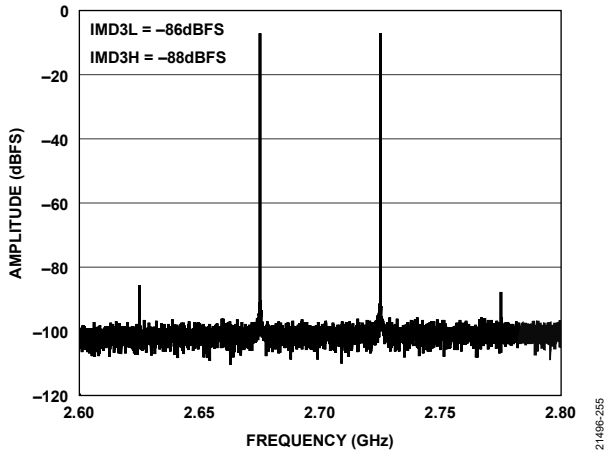

Figure 55. Two-Tone FFT,  $f_{IN1} = 2.675$  GHz,  $f_{IN2} = 2.725$  GHz, and  $A_{IN1}$  and  $A_{IN2} = -7$  dBFS

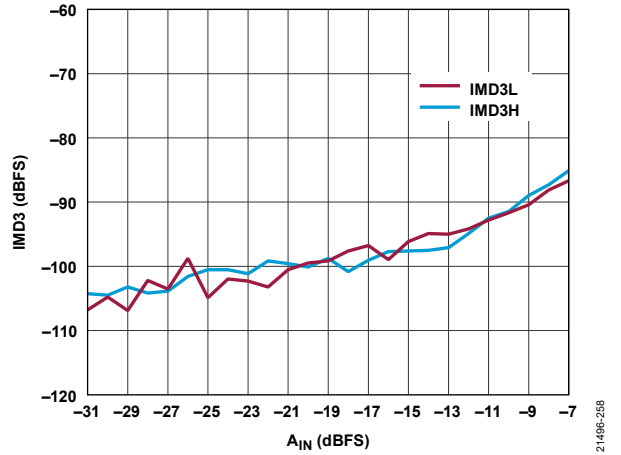

Figure 58. Two-Tone IMD3 vs.  $A_{IN}$  with  $f_{IN1} = 2.675$  GHz and  $f_{IN2} = 2.725$  GHz

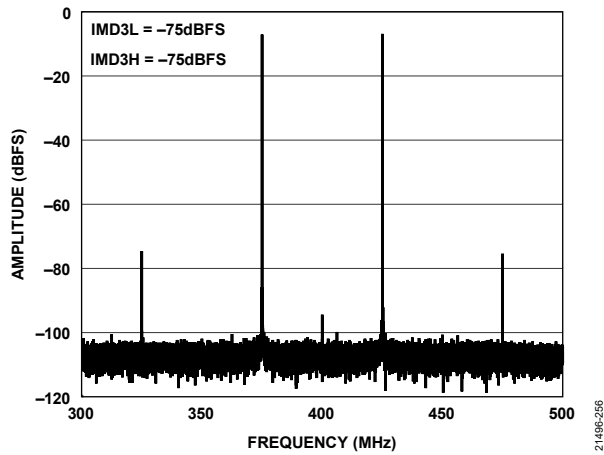

Figure 56. Two-Tone FFT,  $f_{IN1} = 3.575$  GHz,  $f_{IN2} = 3.625$  GHz, and  $A_{IN1}$  and  $A_{IN2} = -7$  dBFS

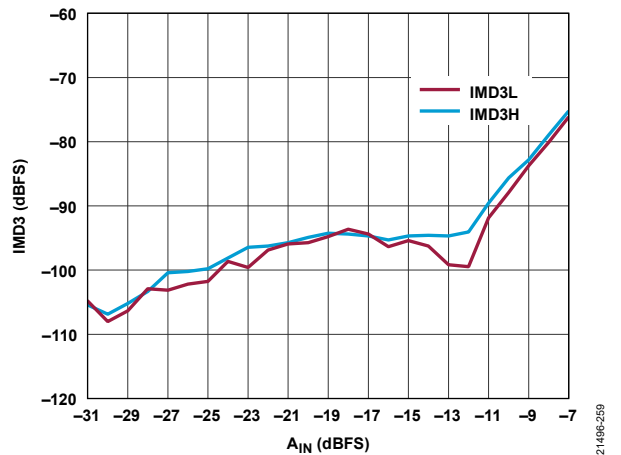

Figure 59. Two-Tone IMD3 vs.  $A_{IN}$  with  $f_{IN1} = 3.575$  GHz and  $f_{IN2} = 3.625$  GHz

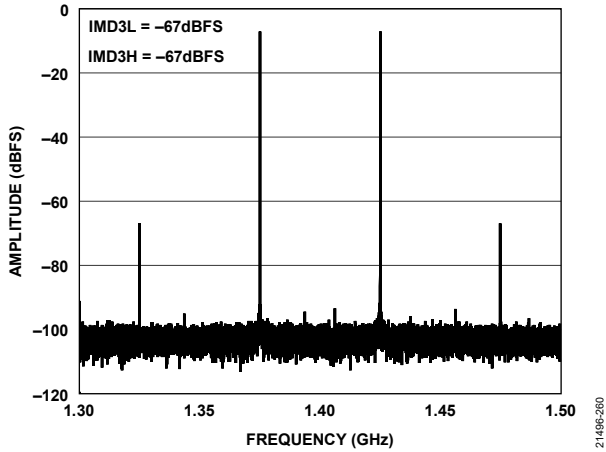

Figure 60. Two-Tone FFT,  $f_{IN1} = 5.375$  GHz,  $f_{IN2} = 5.425$  GHz, and  $A_{IN1}$  and  $A_{IN2} = -7$  dBFS

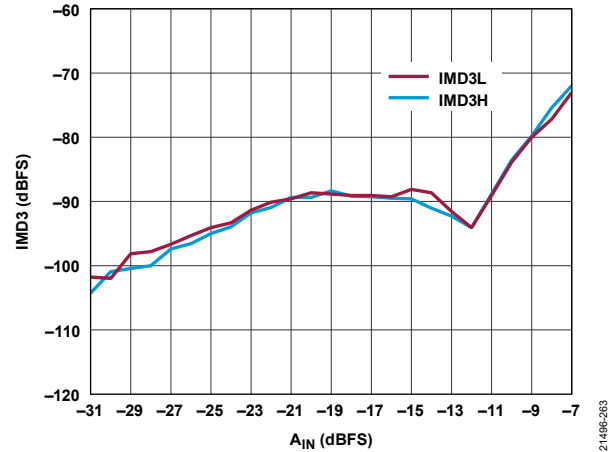

Figure 63. Two-Tone IMD3 vs. Input Amplitude with  $f_{IN1} = 5.375$  GHz and  $f_{IN2} = 5.425$  GHz

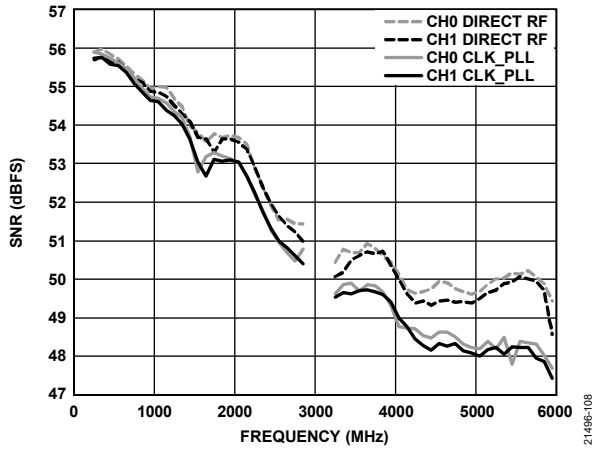

Figure 61. SNR vs. Frequency with  $A_{IN} = -1$  dBFS Between Direct External RF Clock = 6 GHz and PLL Clock Multiplier Enabled with Reference Input of 125 MHz

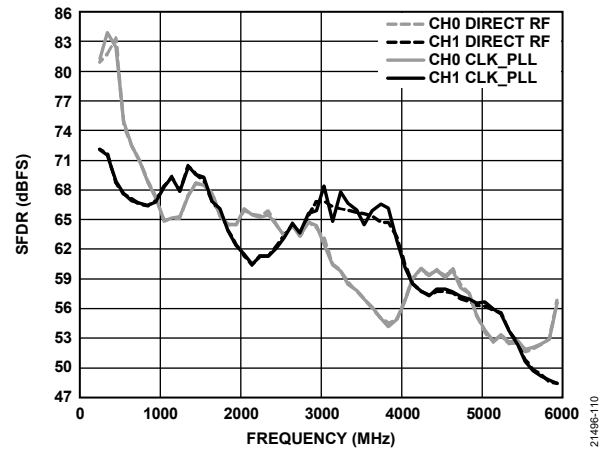

Figure 64. SFDR vs. Frequency with  $A_{IN} = -1$  dBFS Between Direct External RF Clock = 6 GHz and PLL Clock Multiplier Enabled with Reference Input of 125 MHz

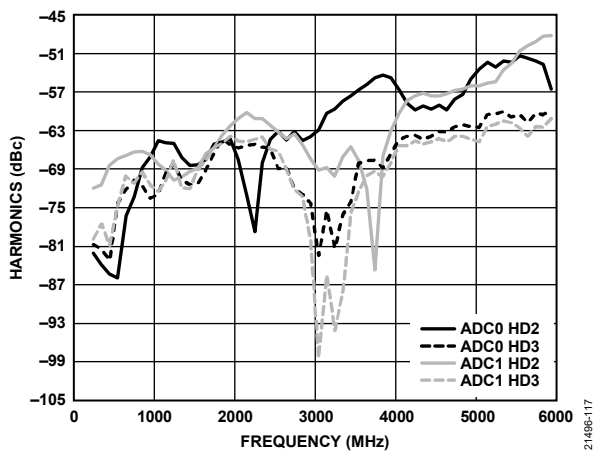

Figure 62. Harmonics (HD2 and HD3) vs. Frequency with  $A_{IN} = -1$  dBFS

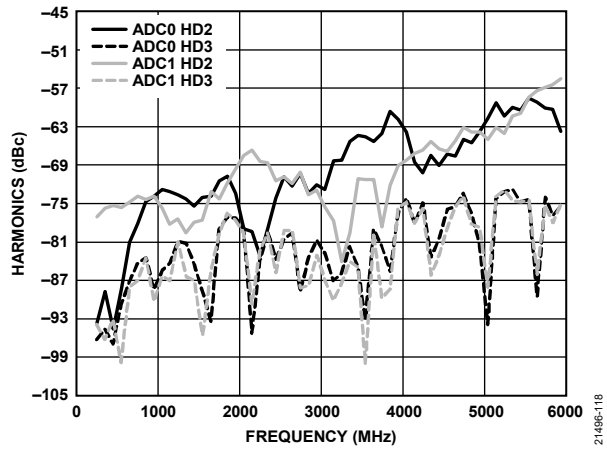

Figure 65. Harmonics (HD2 and HD3) vs. Frequency with  $A_{IN} = -9$  dBFS

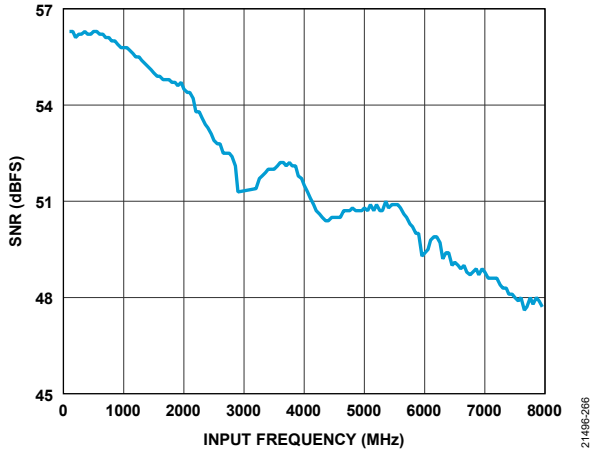

Figure 66. SNR vs. Frequency with  $A_{IN} = -1$  dBFS

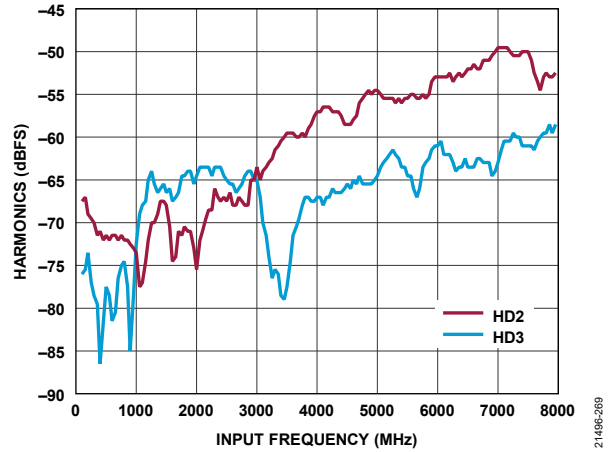

Figure 69. Harmonics (HD2 and HD3) vs. Frequency with  $A_{IN} = -1$  dBFS

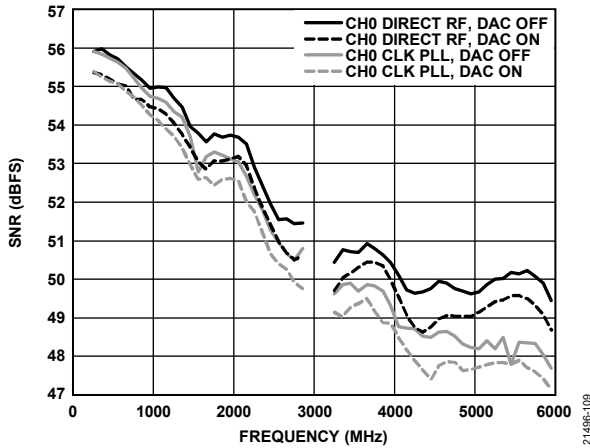

Figure 67. SNR vs. Frequency with  $A_{IN} = -1$  dBFS with DAC On/Off and PLL On/Off Between Direct External RF Clock = 6 GHz and PLL Clock Multiplier Enabled with Reference Input of 125 MHz

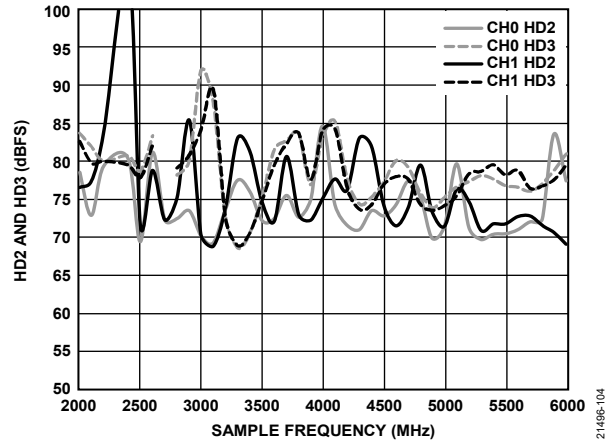

Figure 70. HD2 and HD3 vs. Sample Frequency ( $f_s$ ),  $f_{IN} = 450$  MHz,  $A_{IN} = -1$  dBFS,  $f_s = 2$  GSPS to 6 GSPS

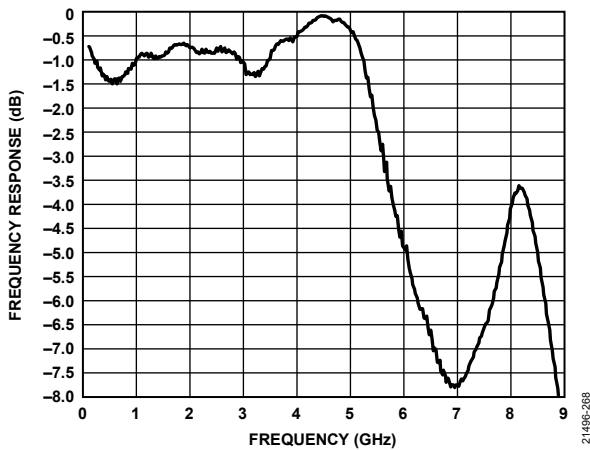

Figure 68. Measured ADC Input Bandwidth on the [AD9082-FMCA-EBZ](#) (No Matching Network)

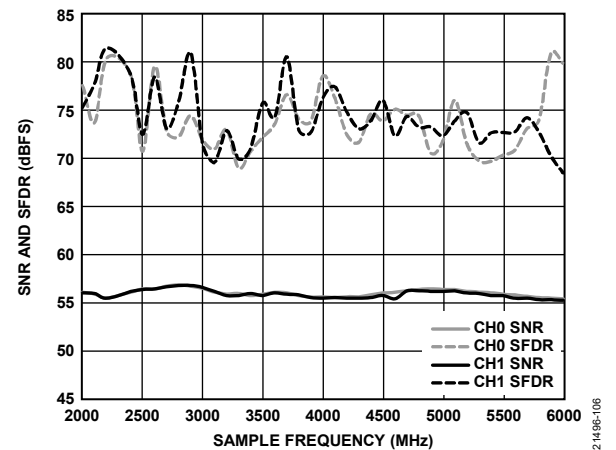

Figure 71. SNR and SFDR vs. Sample Frequency,  $f_{IN} = 450$  MHz,  $A_{IN} = -1$  dBFS,  $f_s = 2$  GSPS to 6 GSPS

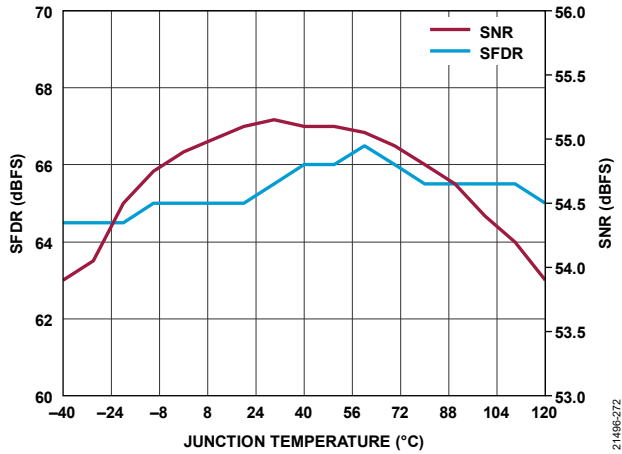

Figure 72. SFDR and SNR vs. Die Temperature,  $f_{IN} = 1.8$  GHz,  $A_{IN} = -1$  dBFS

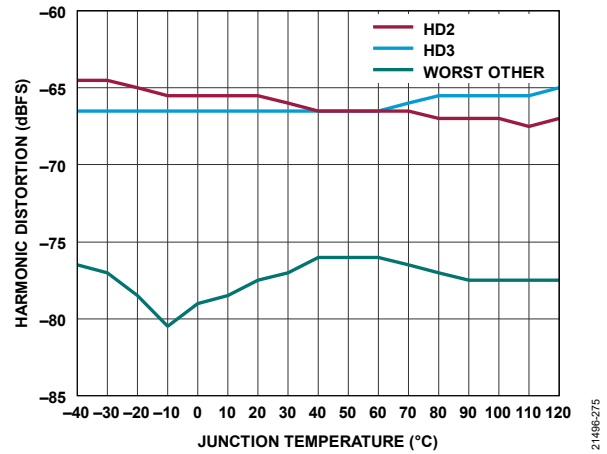

Figure 75. Harmonics vs. Die Temperature,  $f_{IN} = 1.8$  GHz,  $A_{IN} = -1$  dBFS

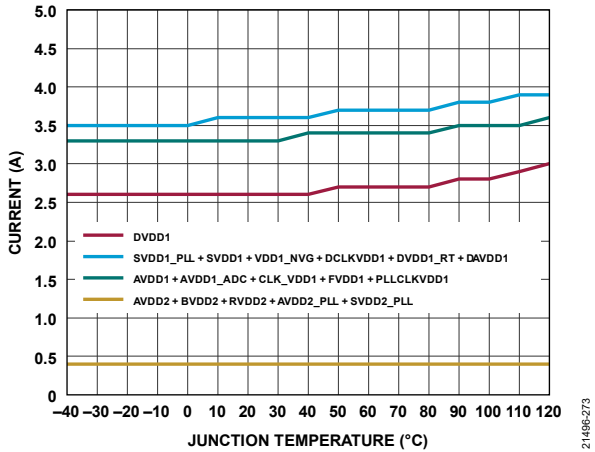

Figure 73. Power vs. Die Temperature,  $f_{IN} = 1.8$  GHz,  $A_{IN} = -1$  dBFS

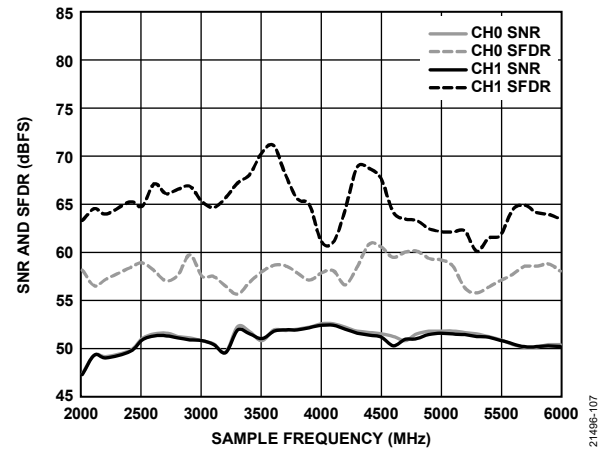

Figure 76. SNR and SFDR vs. Sample Frequency,  $f_{IN} = 3450$  MHz,  $A_{IN} = -1$  dBFS,  $f_s = 2$  GSPS to 6 GSPS

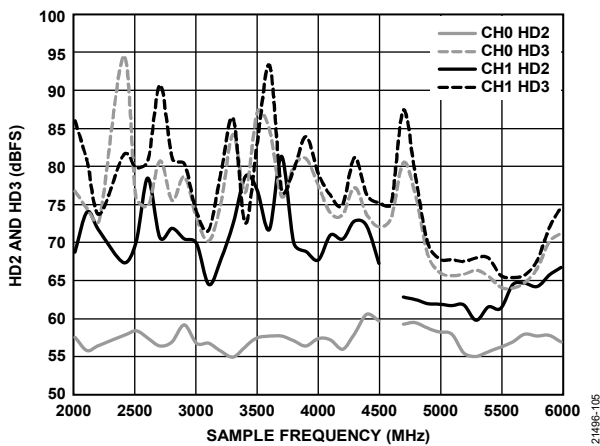

Figure 74. HD2 and HD3 vs. Sample Frequency,  $f_{IN} = 3450$  MHz,  $A_{IN} = -1$  dBFS,  $f_s = 2$  GSPS to 6 GSPS

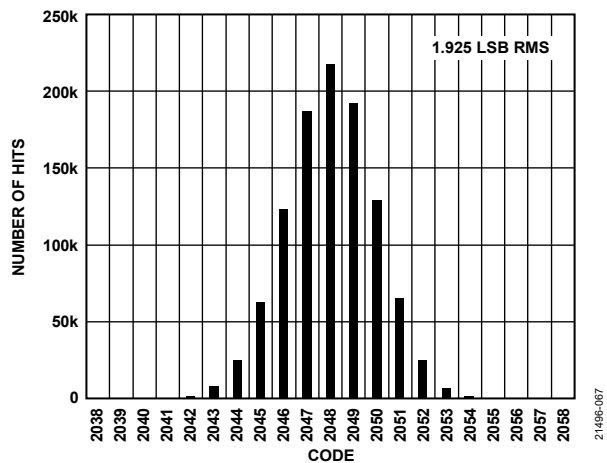

Figure 77. Input Referred Noise Histogram

## THEORY OF OPERATION

The AD9082 is a highly integrated, 28 nm, RF, MxFE featuring four 16-bit, 12 GSPS DAC cores and two 12-bit, 6 GSPS ADC cores (see Figure 1). The DAC core is based on a current segmentation architecture providing a differential complementary current output with an adjustable  $I_{OUTFS}$  range of 6.43 mA to 37.75 mA. The ADC core is based on a proprietary interleaved architecture that suppresses residual interleaving spurious products into the noise floor. To enable wide bandwidth operation, a high linearity  $100\ \Omega$  differential buffer with overload protection is used to isolate the ADC core from the RF ADC driver source. An on-chip clock multiplier can be used to synthesize the RF DAC and ADC clocks or, alternatively, an external clock can be applied.

Flexible transmit and receive DSP paths are available to up and down sample the desired intermediate frequency (IF) or RF signal(s) to manageable data interface rates aligned with bandwidth requirements. The transmit and receive DSP paths are symmetric and consist of four CDUC and CDDC blocks in the main datapath along with eight FDUC and FDDC blocks in the channelizer datapath. Each block includes a 48-bit NCO configurable for integer or fractional mode of operation. The channelizer datapath enables an efficient implementation to support multiband applications where up to eight RF bands can be supported. Each of the DUC and DDC blocks are bypassable and offer flexible interpolating and decimation factors. The NCO in each block also supports coherent frequency hopping.

Additional features are also included in the receive and transmit datapaths as well as elsewhere to facilitate system integration. Both datapaths include adjustable delay lines to compensate for mismatch in channel delay paths that may occur external to the

device. The transmit datapath includes digital gain control, fine delay adjust, and power amplifier protection to simplify DPD integration in a multiband transmitter. The receive path includes a flexible programmable 192-tap finite impulse response (PFIR) filter. The filter can be allocated across one or more ADCs for receive equalization with support for four different profiles. These profiles can be selected using the GPIOx pins. The receive datapath also includes a fast and slow signal detection capability in support of automatic gain control (AGC). Transmit and receive data formatting can be real or complex with resolutions of 8, 12, 16, and 24 bits depending on the JESD204B or the JESD204C mode. The AD9082 also allows complete bypass of the transmit and receive DSP paths enabling Nyquist operation.

The device also supports fast frequency hopping via GPIOx and a low latency digital loopback capability. An on-chip TMU is also included and can be used as part of a thermal management solution. Power savings option in support of time division duplex (TDD) applications are included.

A 16-lane JESD204 transceiver port is available to support the high data throughput rates on the receive and transmit datapaths. Eight SERDES lanes are designated for the transmit datapaths, whereas the other 8 lanes are designated for the receive datapaths with the option to support two links. The transceiver port supports JESD204C up to 24.75 Gbps or JESD204B up to 15.5 Gbps lane rates. The JESD204 data link layer is highly flexible allowing optimization of the lane count (or rate) required to support a target throughput rate. Internal synchronization for deterministic latency and phase alignment as well as multichip synchronization are possible via an external alignment signal (SYSREF).

OUTLINE DIMENSIONS

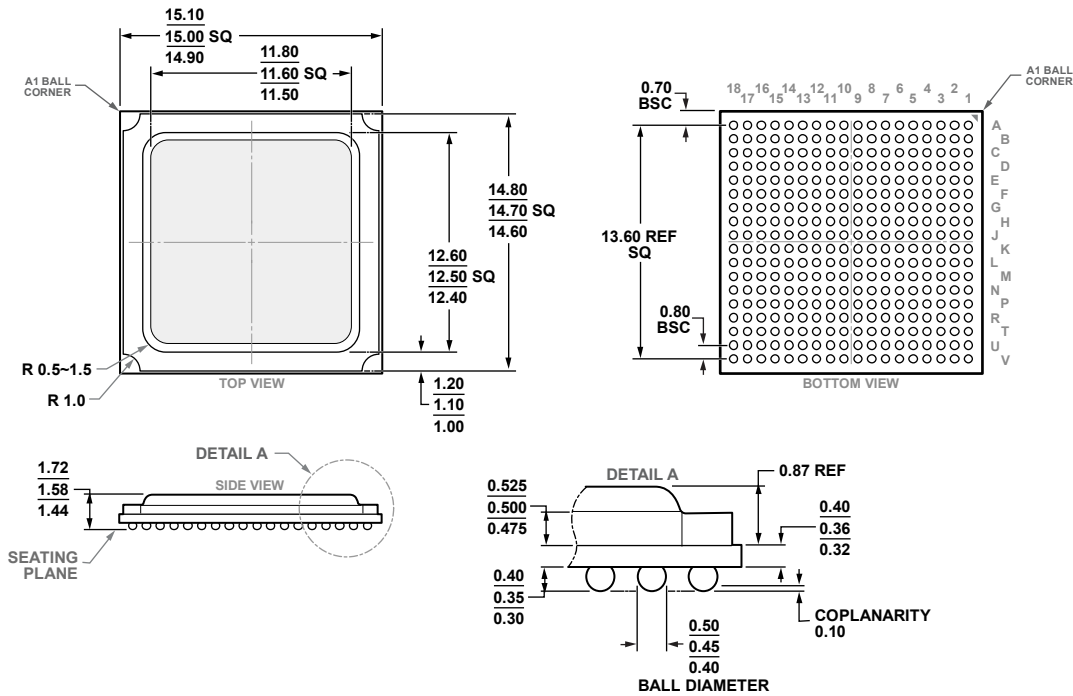

COMPLIANT TO JEDEC STANDARDS MO-275-KKAB-1

Figure 78. 324-Ball Ball Grid Array, Thermally Enhanced [BGA\_ED] (BP-324-3)

Dimensions shown in millimeters

ORDERING GUIDE

Model <sup>1</sup>	Temperature Range <sup>2</sup>	Package Description	Packing Quantity	Package Option
AD9082BBPZ-4D2AC	-40°C to +120°C	324-Ball BGA_ED	Tray, 126	BP-324-3
AD9082BBPZRL-4D2AC	-40°C to +120°C	324-Ball BGA_ED	Reel, 1000	BP-324-3
AD9082BBPZ-2D2AC	-40°C to +120°C	324-Ball BGA_ED	Tray, 126	BP-324-3
AD9082BBPZRL-2D2AC	-40°C to +120°C	324-Ball BGA_ED	Reel, 1000	BP-324-3
AD9082-FMCA-EBZ		AD9082 Evaluation Board with High Performance Analog Network		

<sup>1</sup> Z = RoHS Compliant Part.

<sup>2</sup> Specified operating junction temperature (T<sub>j</sub>).

## Looking for pricing, stock, or lifecycle information?

Click below to explore more details on WIN SOURCE:

- ⊖ [View AD9082BBPZRL-2D2AC on WIN SOURCE](#)
- ⊖ [Analog Devices Inc. Information](#)

## Optimize Your Supply Chain with WIN SOURCE Solutions

- ✓ Global Sourcing Solution
- ✓ Obsolete Management
- ✓ Cost Control Management
- ✓ Shortage Management
- ✓ Alternative Solution
- ✓ Excess Inventory Management