



**THE DATASHEET OF
ADF5709BEZ**



FEATURES

- Wide output frequency range: 9.85 GHz to 20.5 GHz**
- Wide tuning bandwidth**
- Low single sideband phase noise: -83 dBc/Hz at 100 kHz offset**
- No external resonator needed**
- Supply current: 70 mA typical at $V_{CC} = 5$ V**
- 24-terminal, 3.90 mm × 3.90 mm, ceramic LCC package**

APPLICATIONS

- Industrial and medical equipment**
- Test and measurement equipment**
- Military radars, electronic warfare (EW), and electronic countermeasures (ECMs)**
- Point to point and multipoint radios**
- Very small aperture terminals (VSATs)**
- Wireless communication infrastructure**

GENERAL DESCRIPTION

The ADF5709 wideband, monolithic microwave integrated circuit (MMIC), voltage controlled oscillator (VCO) supports an output frequency (f_{OUT}) range of 9.85 GHz to 20.5 GHz while maintaining -83 dBc/Hz phase noise at 100 kHz offset without subharmonic tones. The wide frequency tuning range and low phase noise allow phase-locked loop (PLL) solutions for a variety of frequency bands and limit the need for multiple narrow-band VCOs. The broad frequency coverage reduces the board design complexity and simplifies the bill of materials when designing RF and microwave applications.

The VCO operates from a single 5 V supply and consumes only 70 mA of supply current that results in minimal power dissipation. The ADF5709 low power consumption is ideal for high performance applications with limited or no airflow. The monolithic construction of the VCO allows optimal output power and noise characteristics over temperature variations.

The VCO is fully integrated and incorporates a resonator, a negative resistance device, and a varactor diode that minimize the number of external components and reduces board space.

FUNCTIONAL BLOCK DIAGRAM

Figure 1.

The low input impedance on the V_{TUNE} pin of the ADF5709 enables high tuning speed and modulation bandwidth, which allows faster frequency sweeps and lock times when used as part of a frequency synthesizer, for example, in radar or in test and measurement applications.

The ADF5709 is encapsulated into a **tiny, 3.90 mm × 3.90 mm, RoHS compliant, ceramic leadless chip carrier (LCC) package**. The package includes through vias to the exposed pad, enhancing thermal characteristics.

The small size, optimal noise performance, low power consumption, and wide tuning range of the ADF5709 make the device ideal for many applications requiring flexibility, high performance, a small footprint, and a tight power budget.

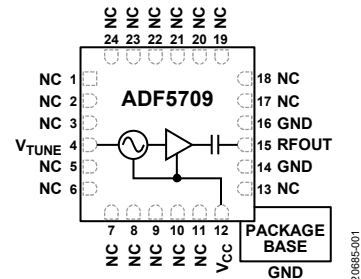
The ADF5709 is pin to pin compatible with the [HMC733](#) and other Analog Devices, Inc., wideband VCOs.

TABLE OF CONTENTS

Features	1	ESD Caution	4
Applications	1	Pin Configuration and Function Descriptions	5
Functional Block Diagram	1	Interface Schematics	5
General Description	1	Typical Performance Characteristics	6
Revision History	2	Applications Information	8
Specifications	3	Outline Dimensions.....	9
Absolute Maximum Ratings	4	Ordering Guide	9
Thermal Resistance	4		
Electrostatic Discharge (ESD) Ratings	4		

REVISION HISTORY

12/2020—Revision A: Initial Version

SPECIFICATIONS

$T_A = -40^\circ\text{C}$ to $+85^\circ\text{C}$ and $V_{CC} = 5\text{ V}$, unless otherwise noted.

Table 1.

Parameter	Min	Typ	Max	Unit	Test Conditions/Comments
FREQUENCY					
f_{OUT}	9.85		20.5	GHz	
Drift Rate		0.5		MHz/ $^\circ\text{C}$	
Pulling		15		MHz p-p	Pulling into a 2.0:1 voltage standing wave ratio (VSWR)
Pushing		-240		MHz/V	Frequency = 20.5 GHz
OUTPUT POWER (P_{OUT})					
RFOUT	-4.5	0	+2	dBm	Temperature = 25°C
	-6		+4	dBm	
Supply Current (I_{CC})		70	87	mA	
HARMONICS, SUBHARMONICS					
Second		-15		dBc	
Third		-30		dBc	Measured to 16.67 GHz due to test equipment limitation
TUNING					
Voltage (V_{TUNE})	-0.5		+23	V	
Sensitivity	220		870	MHz/V	9.8 GHz to 20.5 GHz only
Tune Port Leakage Current			100	μA	$V_{TUNE} = 23\text{ V}$
OUTPUT RETURN LOSS		10		dB	
SINGLE SIDEBAND PHASE NOISE					
10 kHz Offset		-51			
100 kHz Offset		-83	-70	dBc/Hz	
1 MHz Offset		-115			
10 MHz Offset		-135		dBc/Hz	

ABSOLUTE MAXIMUM RATINGS

Table 2.

Parameter	Rating
V _{CC}	5.5 V dc
V _{TUNE}	–1 V to +25 V
Temperature	
Operating	–40°C to +85°C
Storage	–65°C to +150°C
Nominal Junction (to Maintain 1 Million Hours Mean Time to Failure (MTTF))	135°C
Nominal Junction (T _A = 85°C)	119°C
Peak Reflow (Moisture Sensitivity Level 3 (MSL3) Rating)	260°C

Stresses at or above those listed under Absolute Maximum Ratings may cause permanent damage to the product. This is a stress rating only; functional operation of the product at these or any other conditions above those indicated in the operational section of this specification is not implied. Operation beyond the maximum operating conditions for extended periods may affect product reliability.

THERMAL RESISTANCE

Thermal performance is directly linked to printed circuit board (PCB) design and operating environment. Careful attention to PCB thermal design is required.

θ_{JA} is specified for the worst-case conditions, that is, a device soldered in a circuit board for surface-mount packages. θ_{JC} is the thermal resistance from the operating portion of the device to the outside surface of the package (case) closest to the device mounting area.

Table 3. Thermal Resistance

Package Type ¹	θ_{JA}	θ_{JC}	Unit
E-24-2	58.6	21.9	°C/W

¹ The thermal impedance simulated values are based on the JESD-51 standard using 2S2P on FR4 with four standard JEDEC vias (0.3 mm diameter, 0.025 mm plating, and 1.2 mm pitch).

ELECTROSTATIC DISCHARGE (ESD) RATINGS

The following ESD information is provided for handling of ESD-sensitive devices in an ESD protected area only.

Human body model (HBM) per ANSI/ESDA/JEDEC JS-001.

ESD Ratings for ADF5709

Table 4. ADF5709, 24-Terminal Ceramic LCC

ESD Model	Withstand Threshold (V)	Class
HBM ¹	250	1A

ESD CAUTION



ESD (electrostatic discharge) sensitive device. Charged devices and circuit boards can discharge without detection. Although this product features patented or proprietary protection circuitry, damage may occur on devices subjected to high energy ESD. Therefore, proper ESD precautions should be taken to avoid performance degradation or loss of functionality.

PIN CONFIGURATION AND FUNCTION DESCRIPTIONS

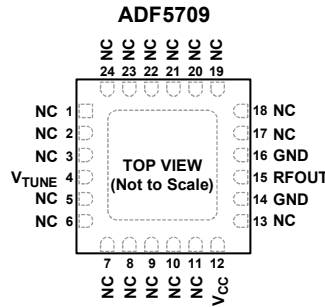

- NOTES**
1. NC = NO CONNECT. HOWEVER, THESE PINS CAN BE CONNECTED TO RF OR DC GROUND WITHOUT AFFECTING THE PERFORMANCE OF THE DEVICE.
 2. EXPOSED PAD. THE PACKAGE BOTTOM HAS AN EXPOSED METAL PAD THAT MUST BE CONNECTED TO RF OR DC GROUND.

20685-002

Figure 2. Pin Configuration

Table 5. Pin Function Descriptions

Pin No.	Mnemonic	Description
1 to 3, 5 to 11, 13, 17 to 24	NC	No Connect. However, these pins can be connected to RF or dc ground without affecting the performance of the device.
4	V _{TUNE}	Control Voltage and Modulation Input. The modulation bandwidth is dependent on the drive source impedance.
12	V _{CC}	Supply Voltage (5 V dc).
14, 16	GND	Ground. The GND pins must be connected to RF or dc ground.
15	RFOUT	RF Output. The RFOUT pin is ac-coupled and a VSWR load of $\leq 2.0:1$ must be maintained across frequency. Connect a 100 nF coupling capacitor to the RFOUT pin for protection.
	EP	Exposed Pad. The package bottom has an exposed metal pad that must be connected to RF or dc ground.

INTERFACE SCHEMATICS

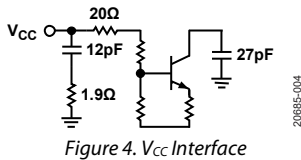
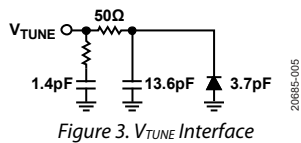

Figure 5. GND Interface



Figure 6. RFOUT Interface

TYPICAL PERFORMANCE CHARACTERISTICS

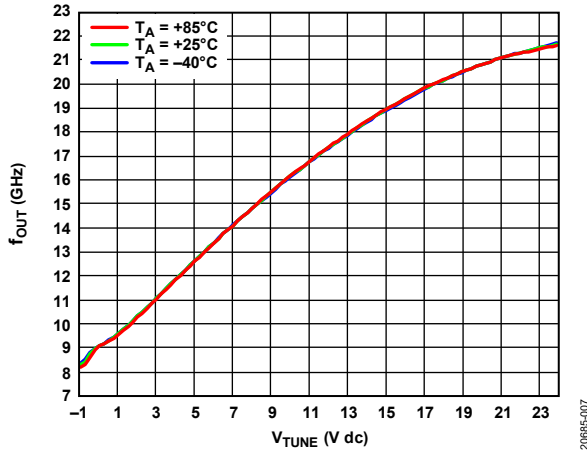

Figure 7. f_{OUT} vs. V_{TUNE} for Various Temperatures

20685-007

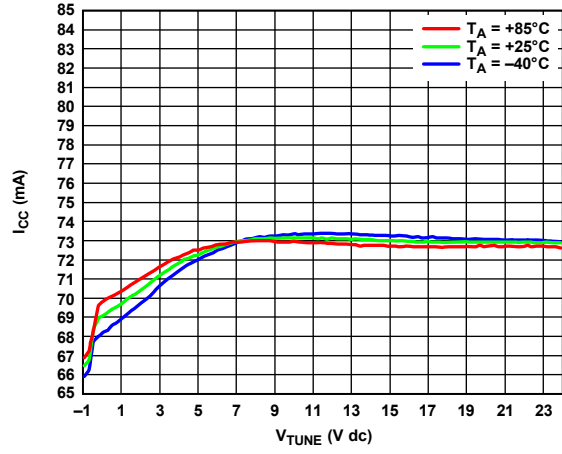

Figure 10. I_{CC} vs. V_{TUNE} for Various Temperatures

20685-010

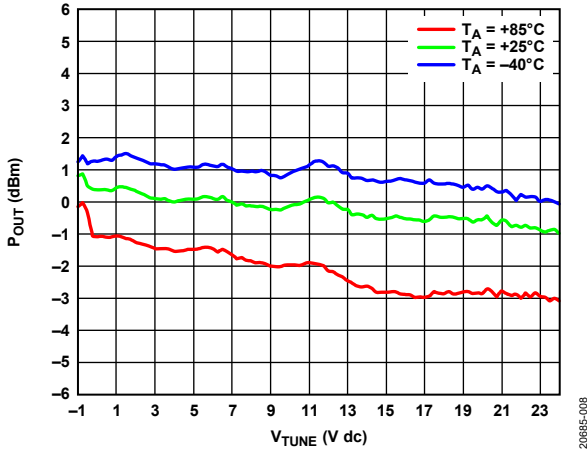

Figure 8. P_{OUT} vs. V_{TUNE} for Various Temperatures

20685-008

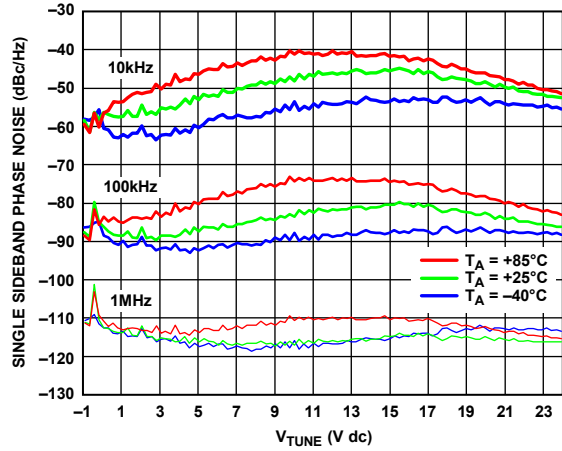

Figure 11. Single Sideband Phase Noise vs. V_{TUNE} for Various Temperatures and Frequencies

20685-011

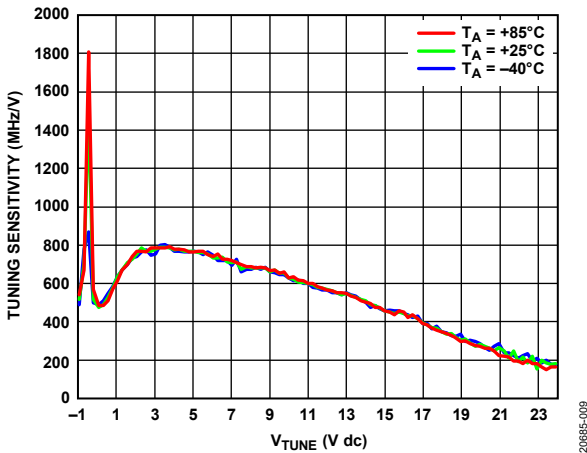

Figure 9. Tuning Sensitivity vs. V_{TUNE} for Various Temperatures

20685-009

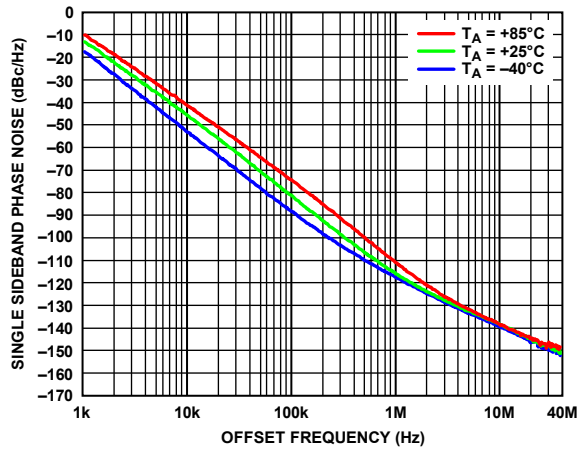

Figure 12. Single Sideband Phase Noise vs. Offset Frequency for Various Temperatures at $V_{TUNE} = 10\text{ V}$

20685-012

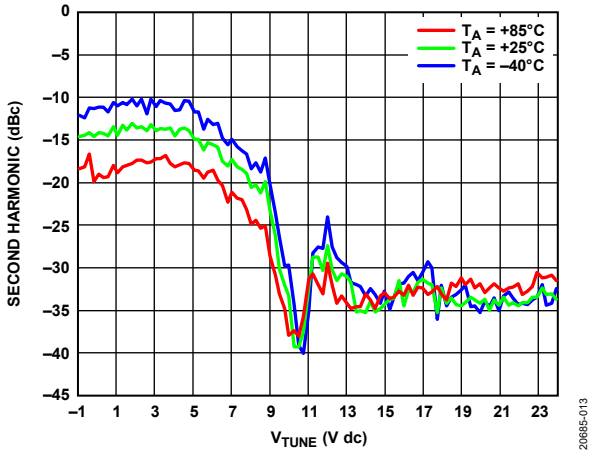

Figure 13. Second Harmonic vs. V_{TUNE} for Various Temperatures

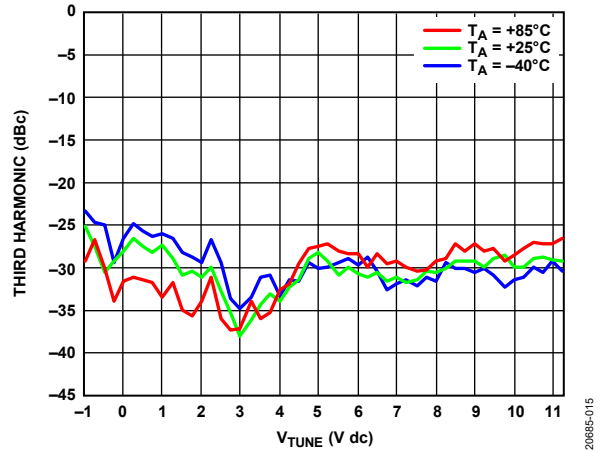

Figure 15. Third Harmonic vs. V_{TUNE} for Various Temperatures, Measured Up to 11 V Only due to Equipment Limitation

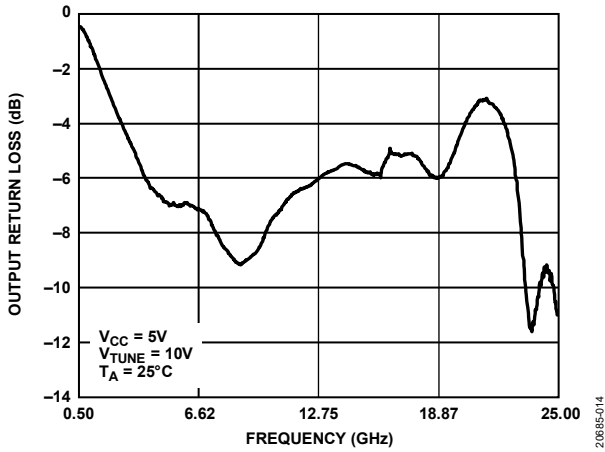

Figure 14. Output Return Loss vs. Frequency at $V_{TUNE} = 10V$

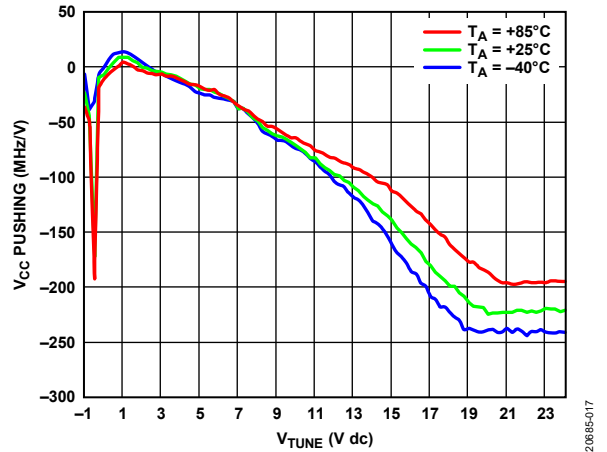

Figure 16. V_{CC} Pushing vs. V_{TUNE} for Various Temperatures

APPLICATIONS INFORMATION

The ADF5709 serves as the local oscillator (LO) in microwave synthesizer applications. The primary applications for this device are point to point and multipoint radios, military radars, test and measurement, industrial and medical equipment, and wireless communication infrastructure. The low phase noise allows higher orders of modulation and offers improved bit error rates in communication systems. The linear, monotonic tuning sensitivity allows a stable loop filter design. The higher output power minimizes the gain required to drive subsequent stages. The cascode output buffer amplifier stage guarantees stability over a wide range of output load conditions and improves the pulling performance of the VCO.

To achieve optimal performance of the VCO, high power supply rejection ratio (PSRR) and low dropout (LDO) regulators are recommended to minimize any spurious frequencies from the power supply and to achieve the lowest phase noise native to the VCO. The [ADM7150](#) and the [LT3042](#) meet these requirements and are acceptable LDO regulators to use.

The wide frequency range of the VCO suggests the use of a low noise, PLL synthesizer, such as the [ADF41513](#). The wide input bandwidth of this synthesizer (1 GHz to 26.5 GHz) makes the ADF41513 an ideal synthesizer for use with the ADF5709. The variable charge pump current allows compensation for VCO sensitivity variation by allowing charge pump currents to be increased or decreased as required. Ensure that optimal RF layout practices are used for the layout of the interconnecting circuits. Give first priority to the microwave power splitter network from the output buffer of the VCO to the RF input pin (RF_{IN}1A) of the ADF41513. Give the next highest priority to the highly sensitive V_{TUNE} line with the first pole placed as close to the ADF41513 CP output pin as possible, and the final RC pole of the filter placed as close to the ADF5709 V_{TUNE} pin as possible. The wide tuning range of the ADF5709 requires the use of a high voltage, low noise, op amp. The [ADA4625-1](#) is acceptable to use for such applications.

The suggested PCB stack up consists of a high quality dielectric material, such as Rogers 4003. The transmission lines carrying the high frequency signal must be carefully controlled, 50 Ω characteristic impedances.

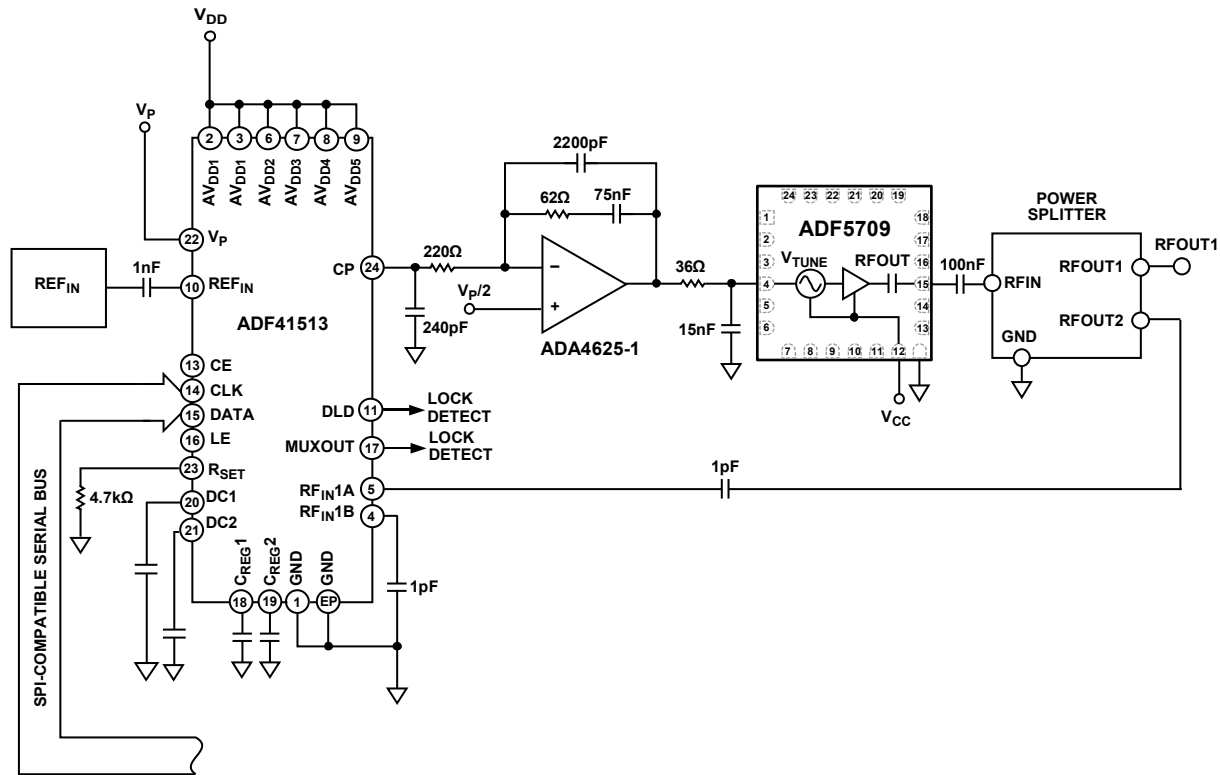

NOTES
THIS IS A SIMPLIFIED SCHEMATIC, DECOUPLING CAPACITORS AND SPI CONNECTION DETAILS HAVE BEEN OMITTED FOR CLARITY.

Figure 17. Typical Application Diagram

2085E-016

OUTLINE DIMENSIONS

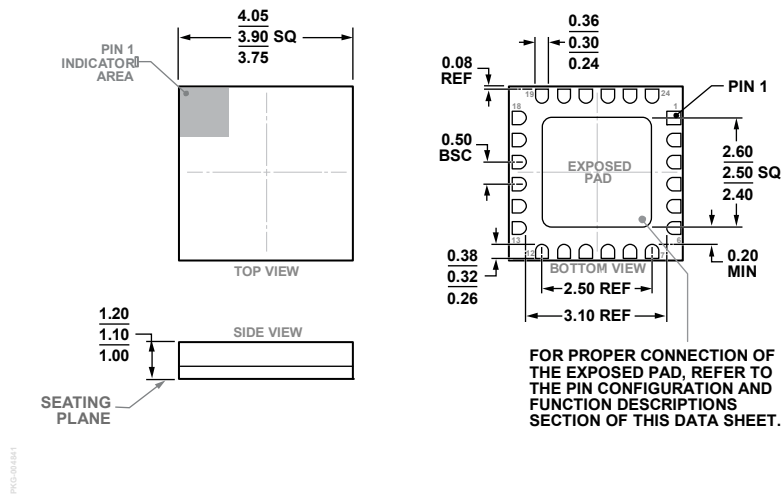

Figure 18. 24-Terminal Ceramic Leadless Chip Carrier [LCC]
(E-24-2)
Dimensions shown in millimeters

ORDERING GUIDE

Model ¹	Temperature Range	MSL Rating ²	Package Description	Package Option
ADF5709BEZ	-40°C to +85°C	MSL3	24-Terminal Ceramic Leadless Chip Carrier [LCC]	E-24-2
ADF5709BEZ-R7	-40°C to +85°C	MSL3	24-Terminal Ceramic Leadless Chip Carrier [LCC]	E-24-2
EV-ADF5709			Evaluation Board	

¹ Z = RoHS Compliant Part.

² See the Absolute Maximum Ratings section.

Looking for pricing, stock, or lifecycle information?

Click below to explore more details on WIN SOURCE:

 [View ADF5709BEZ on WIN SOURCE](#)

 [Analog Devices Inc. Information](#)

Optimize Your Supply Chain with WIN SOURCE Solutions

-  Global Sourcing Solution
-  Obsolete Management
-  Cost Control Management
-  Shortage Management
-  Alternative Solution
-  Excess Inventory Management