



**THE DATASHEET OF
ADMV8818SCCZ-EP**



FEATURES

Digitally tunable, multioctave, high-pass and low-pass tuning
Independent 3 dB frequency control for up to 4 GHz of bandwidth

Optimal wideband rejection: 35 dB

Single chip replacement for discrete filter banks

Compact 9 mm × 9 mm, 56-terminal LGA package

ENHANCED PRODUCT FEATURES

Supports defense and aerospace applications (AQEC standard)

Military temperature range of -55°C to +105°C

Controlled manufacturing baseline

One assembly and test site

One fabrication site

Production change notification

Qualification data available on request

APPLICATIONS

Test and measurement equipment

Military radar, electronic warfare, and electronic countermeasures

Satellite communications and space

Industrial and medical equipment

GENERAL DESCRIPTION

The ADMV8818-EP is a fully monolithic microwave integrated circuit (MMIC) that features a digitally selectable frequency of operation. The device features four independently controlled high-pass filters (HPFs) and four independently controlled low-pass filters (LPFs) that span the 2 GHz to 18 GHz frequency range.

The flexible architecture of the ADMV8818-EP allows the 3 dB cutoff frequency (f_{3dB}) of the high-pass and low-pass filters to be controlled independently to generate up to 4 GHz of bandwidth.

The digital logic control on each filter is 4 bits wide (16 states) and controls the on-chip reactive elements to adjust the f_{3dB} . The typical insertion loss is 9 dB, and the wideband rejection is 35 dB, which is ideally suited for minimizing system harmonics.

This tunable filter can be used as a smaller alternative to large switched filter banks and cavity tuned filters, and this device provides a dynamically adjustable solution in advanced communications applications.

FUNCTIONAL BLOCK DIAGRAM

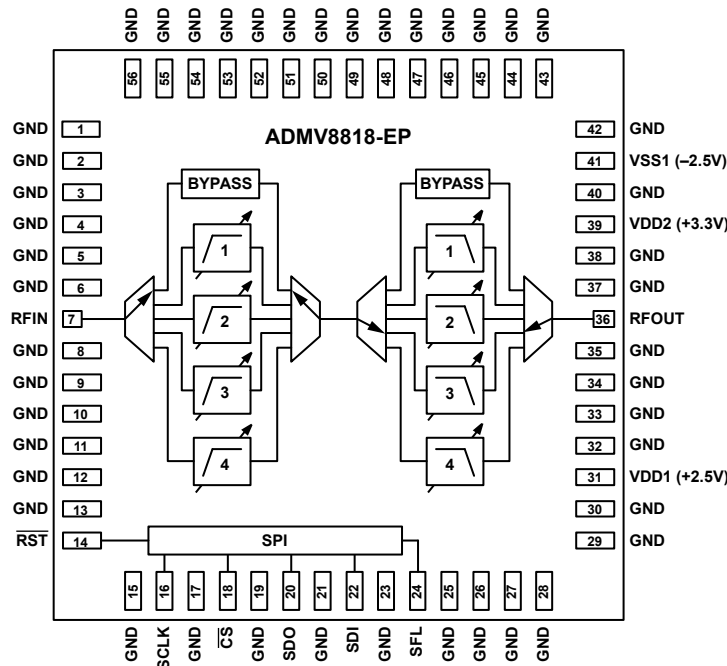

Figure 1.

Rev. A

[Document Feedback](#)

Information furnished by Analog Devices is believed to be accurate and reliable. However, no responsibility is assumed by Analog Devices for its use, nor for any infringements of patents or other rights of third parties that may result from its use. Specifications subject to change without notice. No license is granted by implication or otherwise under any patent or patent rights of Analog Devices. Trademarks and registered trademarks are the property of their respective owners.

TABLE OF CONTENTS

Features.....	1	SPI Configuration	15
Enhanced Product Features	1	RF Connections	15
Applications	1	Mode Selection	15
General Description	1	SPI Write Mode	16
Functional Block Diagram	1	Switch Positions	16
Revision History	2	Switch Set	16
Specifications	3	Filter Settings	16
Timing Specifications	5	Write Group Priority.....	16
Absolute Maximum Ratings	7	Frequency Terminology	16
Electrostatic Discharge (ESD) Ratings	7	SPI Fast Latch Mode	16
ESD Caution.....	7	Chip Reset	17
Pin Configuration and Function Descriptions	8	Applications Information	18
Typical Performance Characteristics.....	9	PCB Design Guidelines	18
4 GHz Constant Bandwidth Data	9	Programming Flow Chart.....	19
Board Loss and Bypass Configuration Data.....	11	Register Summary	20
HPF and LPF Configuration.....	12	Register Details	27
Theory of Operation	14	Outline Dimensions.....	36
Chip Architecture.....	14	Ordering Guide	36
Tunable High-Pass Filters.....	14		
Tunable Low-Pass Filters	15		

REVISION HISTORY

5/2021—Rev. 0 to Rev. A	
Changed ADMV8818 to ADMV8818-EP	Universal
Added Enhanced Product Features Section	1
Changes to Table 1	4
Changes to Electrostatic Discharge (ESD) Ratings Section and Table 4.....	7
Changes to Figure 4, Figure 5, Figure 6, Figure 8, and Figure 9	9
Changes to Figure 10, Figure 11, Figure 13, and Figure 14	10
Changes to Figure 16 and Figure 17	11
Changes to Figure 19, Figure 20, Figure 21, Figure 22, Figure 23, and Figure 24	12
Changes to Figure 25, Figure 26, Figure 27, Figure 28, and Figure 29	13
Changes to Ordering Guide.....	36
12/2020—Revision 0: Initial Version	

SPECIFICATIONS

T_A = 25°C, unless otherwise noted.

Table 1.

Parameter	Min	Typ	Max	Unit	Test Conditions/Comments
FREQUENCY RANGE (f _{3dB})					3 dB cutoff
Bypass Configuration	2		18	GHz	
HPF 1					
State 0		1.75		GHz	
State 15		3.55		GHz	
HPF 2					
State 0		3.40		GHz	
State 15		7.25		GHz	
HPF 3					
State 0		6.60		GHz	
State 15		12.00		GHz	
HPF 4					
State 0		12.50		GHz	
State 15		19.90		GHz	
LPF 1					
State 0		2.05		GHz	
State 15		3.85		GHz	
LPF 2					
State 0		3.35		GHz	
State 15		7.25		GHz	
LPF 3					
State 0		7.00		GHz	
State 15		13.00		GHz	
LPF 4					
State 0		12.55		GHz	
State 15		18.85		GHz	
INSERTION LOSS					
Bypass Configuration					
2 GHz		-3.2		dB	
10 GHz		-4.4		dB	
18 GHz		-6.0		dB	
2 GHz to 6 GHz		-7.3		dB	HPF 1 State 2 and LPF 2 State 11
6 GHz to 10 GHz		-8.6		dB	HPF 2 State 11 and LPF 3 State 8
10 GHz to 14 GHz		-11.8		dB	HPF 3 State 10 and LPF 4 State 5
14 GHz to 18 GHz		-14.6		dB	HPF 4 State 5 and LPF 4 State 13
BANDWIDTH (3 dB)					Smaller bandwidth possible with more insertion loss
2 GHz to 10 GHz		0.5 to 4		GHz	
10 GHz to 18 GHz		1 to 4		GHz	
RESOLUTION					4 bits per filter (LPF and HPF)
HPF 1		0.12		GHz	
HPF 2		0.26		GHz	
HPF 3		0.36		GHz	
HPF 4		0.49		GHz	
LPF 1		0.12		GHz	
LPF 2		0.26		GHz	
LPF 3		0.40		GHz	
LPF 4		0.42		GHz	

Parameter	Min	Typ	Max	Unit	Test Conditions/Comments
WIDEBAND REJECTION FREQUENCY OFFSET					Measured at 35 dB rejection
HPF 1					
State 0		-0.65		ΔGHz	
State 15		-1.25		ΔGHz	
HPF 2					
State 0		-0.85		ΔGHz	
State 15		-2.00		ΔGHz	
HPF 3					
State 0		-1.15		ΔGHz	
State 15		-1.90		ΔGHz	
HPF 4					
State 0		-2.35		ΔGHz	
State 15		-3.10		ΔGHz	
LPF 1					
State 0		0.70		ΔGHz	
State 15		1.00		ΔGHz	
LPF 2					
State 0		0.90		ΔGHz	
State 15		1.60		ΔGHz	
LPF 3					
State 0		2.30		ΔGHz	
State 15		3.10		ΔGHz	
LPF 4					
State 0		2.50		ΔGHz	
State 15		3.95		ΔGHz	
RE-ENTRY FREQUENCY		32		GHz	≤35 dB
RETURN LOSS		10		dB	
DYNAMIC PERFORMANCE					
Input Power for 0.1 dB Compression (P0.1dB)		18		dBm	
Input Third-Order Intercept (IP3)		45		dBm	Input power (P _{IN}) ¹ = 5 dBm per tone
Group Delay Flatness		<0.8		ns	
Amplitude Settling Time		1		μs	To within ≤1 dB of static insertion loss
Phase Settling Time		2		μs	To within ≤2° of static insertion phase
Drift Rate					
Amplitude		-0.018		dB/°C	At 8 GHz
Frequency		-100		ppm/°C	6 GHz to 10 GHz constant bandwidth state
RESIDUAL PHASE NOISE					
At 1 MHz Offset		165		dBc/Hz	
SUPPLY VOLTAGE					
VSS1	-2.6	-2.5	-2.4	V	
VDD1	2.4	2.5	2.6	V	
VDD2	3.2	3.3	3.4	V	
SUPPLY CURRENT (STATIC)					
VSS1	-50			μA	
VDD1			200	μA	
VDD2			50	μA	
SUPPLY CURRENT (DYNAMIC)					
VDD2		f _{SCLK} /2		mA	Where f _{SCLK} is the SCLK toggle frequency in MHz, for example, continuous SPI writing at 10 MHz yields 5 mA of dynamic supply current

Parameter	Min	Typ	Max	Unit	Test Conditions/Comments
LOGIC ($\overline{\text{RST}}$, $\overline{\text{CS}}$, SCLK, SDI, SDO, SFL)					
Logic Low	-0.3	0	+0.8	V	
Logic High	1.2	3.3	3.6	V	

¹ When the insertion loss is less than -20 dB, $P_{IN} = 8$ dBm per tone.

TIMING SPECIFICATIONS

Table 2.

Parameter	Min	Typ	Max	Unit	Test Conditions / Comments
t ₁	10			ns	$\overline{\text{RST}}$ low time to perform reset
	10			ns	SCLK cycle time (write)
t ₂	20			ns	SCLK cycle time (read)
t ₃	2.5			ns	SCLK high time
t ₄	2.5			ns	SCLK low time
t ₅	5			ns	$\overline{\text{CS}}$ falling edge to SCLK rising edge setup time
t ₆	2			ns	SCLK rising edge to $\overline{\text{CS}}$ hold time
t ₇	5			ns	Minimum $\overline{\text{CS}}$ high time for latching in data (for multiple SPI transactions)
t ₈	5			ns	$\overline{\text{CS}}$ rising edge to next SCLK rising edge ignore
t ₉	5			ns	SDI data setup time
t ₁₀	2			ns	SDI data hold time
t ₁₁	10			ns	SFL falling edge (exiting SFL mode) to $\overline{\text{CS}}$ falling edge time (start SPI transaction)
t ₁₂	10			ns	$\overline{\text{CS}}$ rising edge (end SPI transaction) to SFL rising edge time (entering SFL mode)
t ₁₃	10			ns	SFL rising edge to $\overline{\text{CS}}$ falling edge time
t ₁₄	10			ns	$\overline{\text{CS}}$ cycle time (SFL mode)
t ₁₅	2.5			ns	$\overline{\text{CS}}$ high time (SFL mode)
t ₁₆	2.5			ns	$\overline{\text{CS}}$ low time (SFL mode)
t ₁₇		6		ns	SCLK falling edge to SDO valid (load capacitance (C_L) = 10 pF)
t ₁₈		5		ns	SDO rise and fall time (C_L = 10 pF)
t ₁₉		4		ns	$\overline{\text{CS}}$ rising edge to SDO tristate (C_L = 10 pF)

Timing Diagram

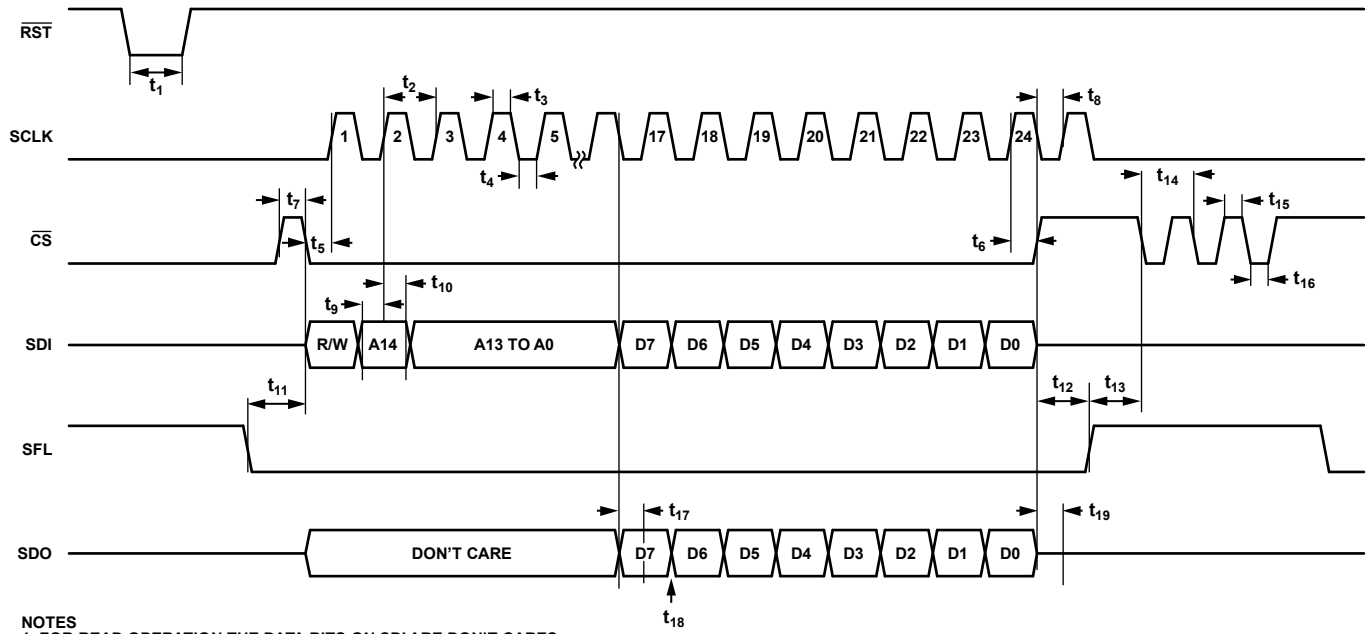

NOTES
 1. FOR READ OPERATION THE DATA BITS ON SDI ARE DON'T CARES.

Figure 2. Timing Diagram

25803-103

ABSOLUTE MAXIMUM RATINGS

Table 3.

Parameter	Rating
SUPPLY	
VDD1	-0.3 V to +2.8 V
VDD2	-0.3 V to +3.6 V
VSS1	-3.6 V to +0.3 V
Digital Control Inputs	
Voltage	-0.3 V to VDD2 + 0.3 V
Current	2 mA
RF Input Power ¹	20 dBm
Temperature	
Operating Range	-55°C to +105°C
Storage Range	-65°C to +150°C
Junction to Maintain 1,000,000 Hours Mean Time to Failure (MTTF)	135°C
Nominal Junction (T _{PADDLE} = 85°C)	90°C
Moisture Sensitivity Level (MSL) Rating	MSL3

¹ Maximum RF input power valid for frequencies above 1 GHz. For incident signals below this frequency, contact Analog Devices, Inc., to discuss the use case scenario.

Stresses at or above those listed under Absolute Maximum Ratings may cause permanent damage to the product. This is a stress rating only; functional operation of the product at these or any other conditions above those indicated in the operational section of this specification is not implied. Operation beyond the maximum operating conditions for extended periods may affect product reliability.

ELECTROSTATIC DISCHARGE (ESD) RATINGS

The following ESD information is provided for handling of ESD-sensitive devices in an ESD protected area only.

Human body model (HBM) per ANSI/ESDA/JEDEC JS-001-2010.

Field induced charged device model (FICDM) per JEDEC JESD22-C101E and ANSI/ESDA/JEDEC JS-002.

ESD Ratings for ADMV8818-EP

Table 4. ADMV8818-EP, 56-Terminal LGA

ESD Model	Withstand Threshold (V)	Class
HBM	2000	2
FICDM	500 ¹ 750 ²	III C2b

¹ Per JEDEC JESD22-C101E.

² Per ANSI/ESDA/JEDEC JS-002.

ESD CAUTION



ESD (electrostatic discharge) sensitive device. Charged devices and circuit boards can discharge without detection. Although this product features patented or proprietary protection circuitry, damage may occur on devices subjected to high energy ESD. Therefore, proper ESD precautions should be taken to avoid performance degradation or loss of functionality.

PIN CONFIGURATION AND FUNCTION DESCRIPTIONS

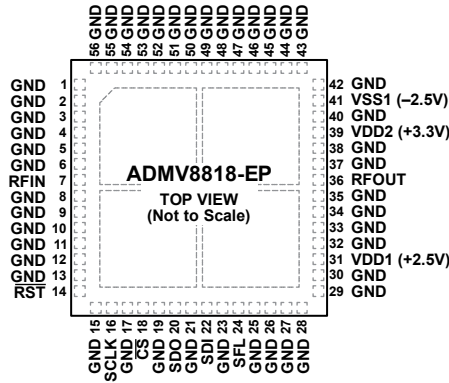

NOTES
 1. EXPOSED PAD. THE EXPOSED PAD MUST BE CONNECTED TO THE RF AND DC GROUND.

256603-102

Figure 3. Pin Configuration

Table 5. Pin Function Descriptions

Pin No.	Mnemonic	Description
1 to 6, 8 to 13, 15, 17, 19, 21, 23, 25 to 30, 32 to 35, 37, 38, 40, 42 to 56	GND	Ground. Connect the GND pins to the RF and dc ground.
7	RFIN	RF Input Pin. RFIN is dc-coupled and matched to 50 Ω. Do not apply an external voltage to RFIN.
14	RST	Chip Reset. 3.3 V logic. Active low. The RST pin is internally pulled high with a 260 kΩ resistor.
16	SCLK	Serial Peripheral Interface (SPI) Clock. 3.3 V logic. The SCLK pin is internally pulled low with a 260 kΩ resistor.
18	CS	SPI Chip Select. 3.3 V logic. Active low. The CS pin is internally pulled low with a 260 kΩ resistor.
20	SDO	SPI Data Output. 3.3 V logic. The SDO pin is internally pulled low with a 260 kΩ resistor.
22	SDI	SPI Data Input. 3.3 V logic. The SDI pin is internally pulled low with a 260 kΩ resistor.
24	SFL	SPI Fast Latch Enable. 3.3 V logic. Set SFL high to enable fast latching of filter states on each rising edge of CS. While SFL is in this mode, the SCLK, SDO, and SDI pins are not active. The SFL pin is internally pulled low with a 260 kΩ resistor.
31	VDD1	2.5 V Power Supply Pin. Place 0.1 μF and 100 pF decoupling capacitors close to VDD1.
36	RFOUT	RF Output Pin. RFOUT is dc-coupled and matched to 50 Ω. Do not apply an external voltage to RFOUT.
39	VDD2	3.3 V Power Supply Pin. Place 0.1 μF and 100 pF decoupling capacitors close to VDD2.
41	VSS1	-2.5 V Power Supply Pin. Place 0.1 μF and 100 pF decoupling capacitors close to VSS1.
	EPAD	Exposed Pad. The exposed pad must be connected to the RF and dc ground.

TYPICAL PERFORMANCE CHARACTERISTICS

4 GHz CONSTANT BANDWIDTH DATA

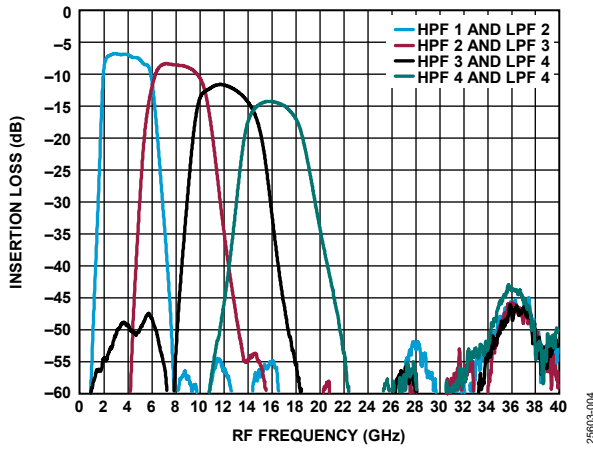

Figure 4. Insertion Loss vs. RF Frequency at 4 GHz Constant Bandwidth

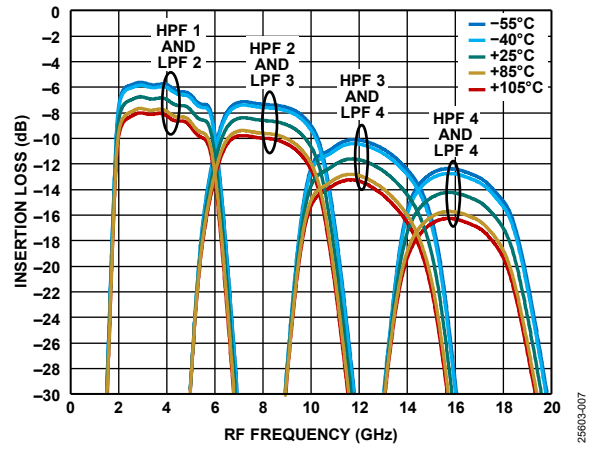

Figure 7. Insertion Loss vs. RF Frequency at 4 GHz Constant Bandwidth and Various Temperatures

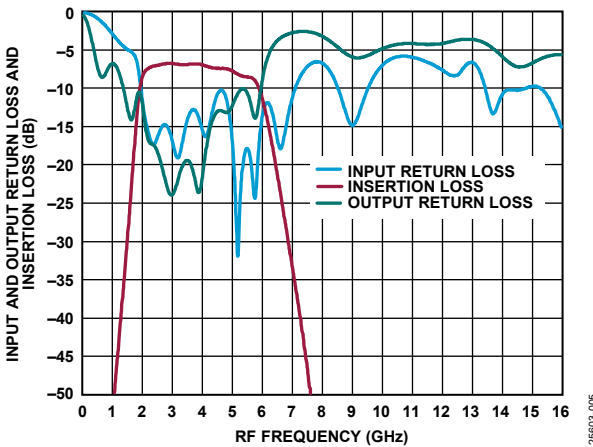

Figure 5. Input and Output Return Loss and Insertion Loss vs. RF Frequency, HPF 1 and LPF 2 Band at 4 GHz Constant Bandwidth

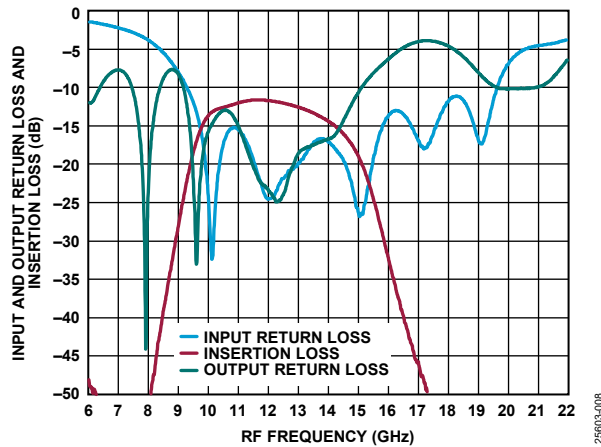

Figure 8. Input and Output Return Loss and Insertion Loss vs. RF Frequency, HPF 3 and LPF 4 Band at 4 GHz Constant Bandwidth

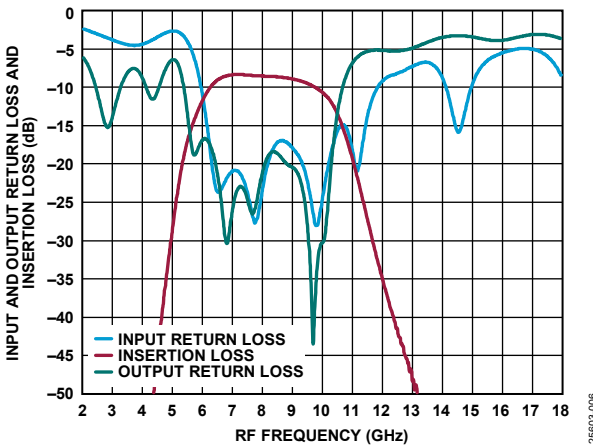

Figure 6. Input and Output Return Loss and Insertion Loss vs. RF Frequency, HPF 2 and LPF 3 Band at 4 GHz Constant Bandwidth

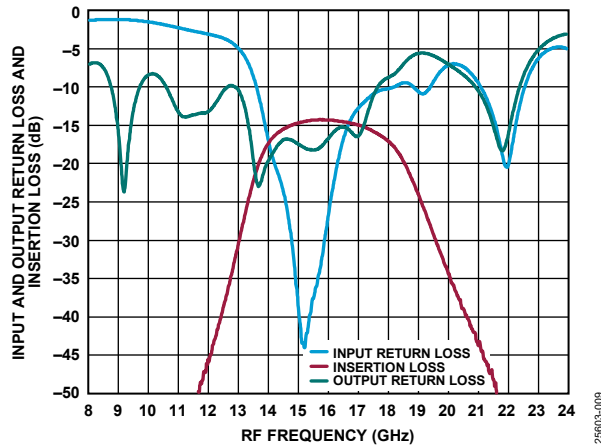

Figure 9. Input and Output Return Loss and Insertion Loss vs. RF Frequency, HPF 4 and LPF 4 Band at 4 GHz Constant Bandwidth

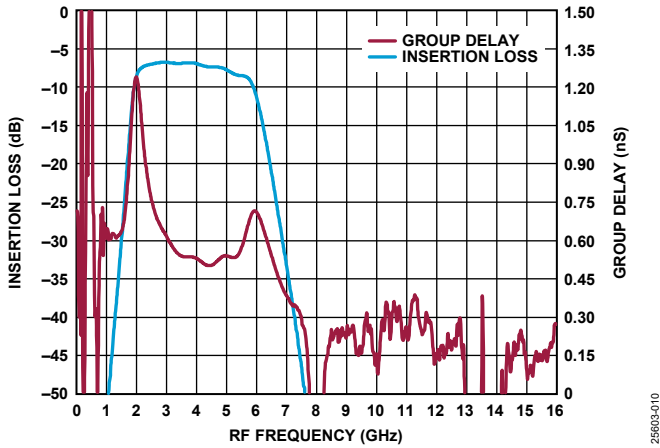

Figure 10. Insertion Loss and Group Delay vs. RF Frequency, HPF 1 and LPF 2 at 4 GHz Constant Bandwidth

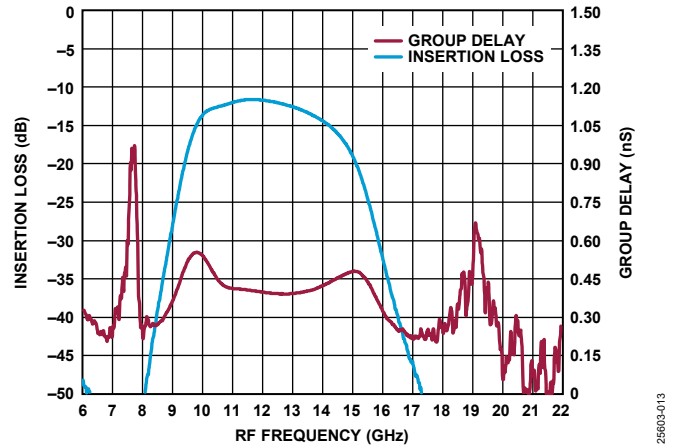

Figure 13. Insertion Loss and Group Delay vs. RF Frequency, HPF 3 and LPF 4 at 4 GHz Constant Bandwidth

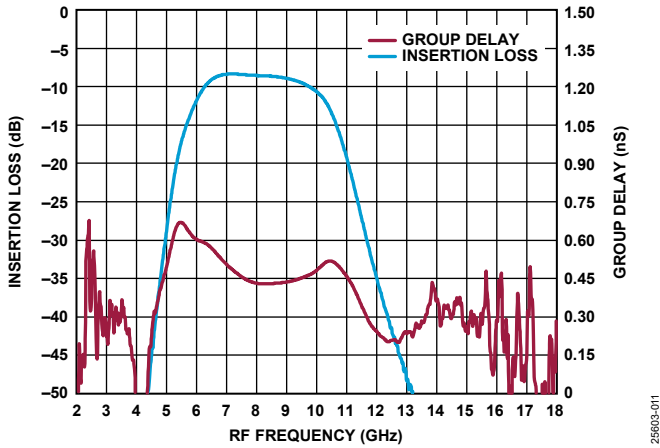

Figure 11. Insertion Loss and Group Delay vs. RF Frequency, HPF 2 and LPF 3 at 4 GHz Constant Bandwidth

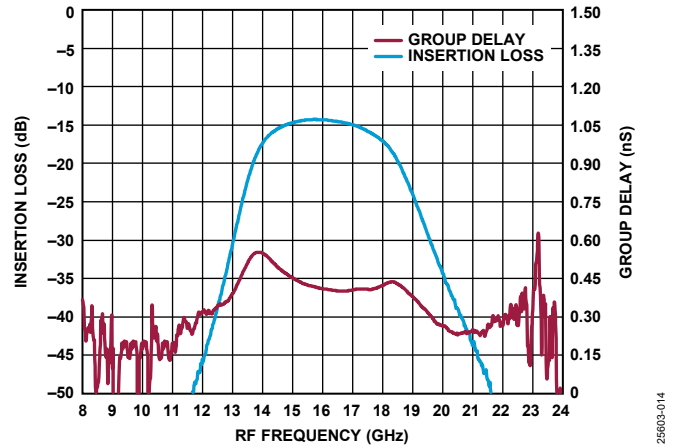

Figure 14. Insertion Loss and Group Delay vs. RF Frequency, HPF 4 and LPF 4 at 4 GHz Constant Bandwidth

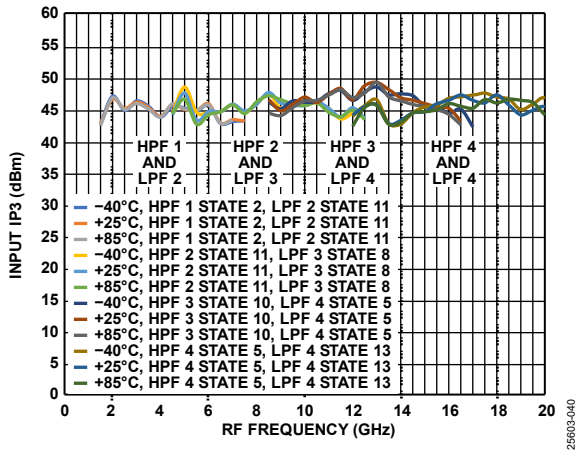

Figure 12. Input IP3 vs. RF Frequency, 4 GHz, 3 dB Bandwidth Configuration at Various Temperatures

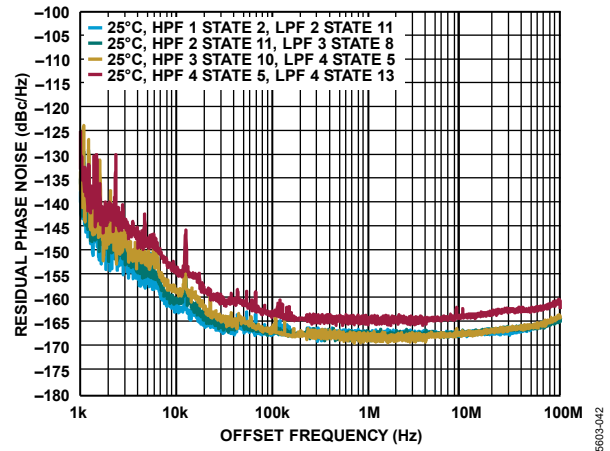

Figure 15. Residual Phase Noise vs. Offset Frequency

BOARD LOSS AND BYPASS CONFIGURATION DATA

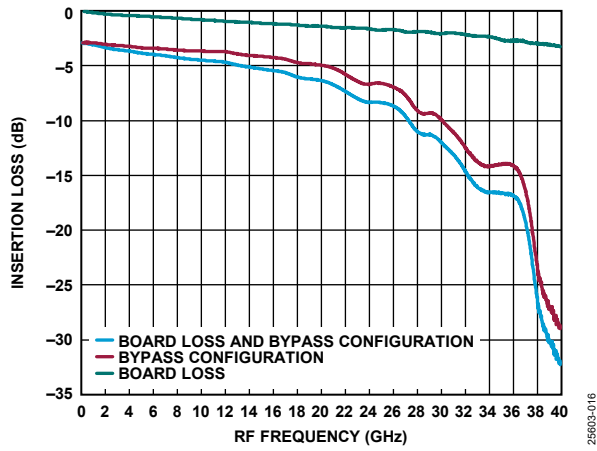

Figure 16. Insertion Loss vs. RF Frequency for Board Loss and Bypass Configuration

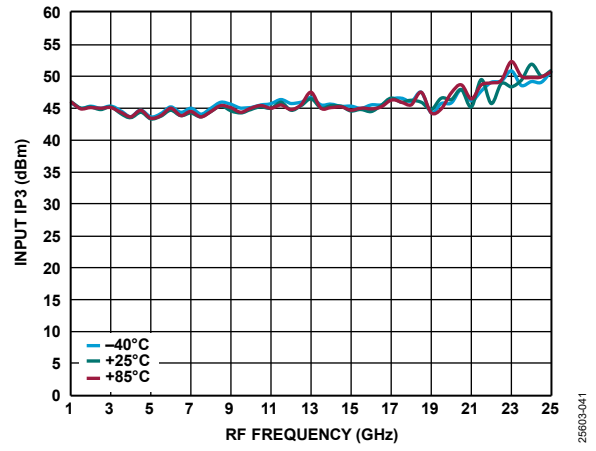

Figure 18. Input IP3 vs. RF Frequency for Various Temperatures, Bypass Configuration

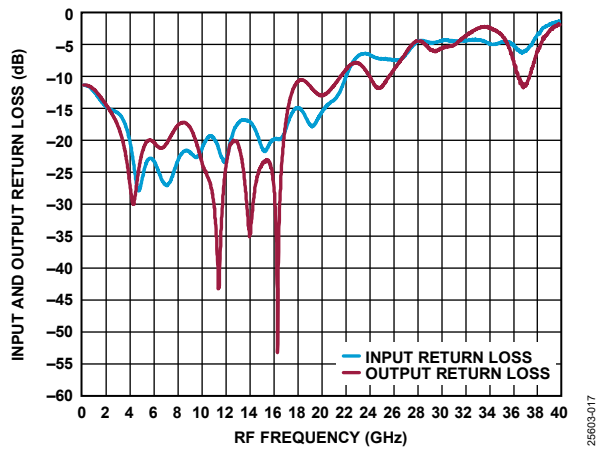

Figure 17. Input and Output Return Loss vs. RF Frequency in Bypass Configuration

HPF AND LPF CONFIGURATION

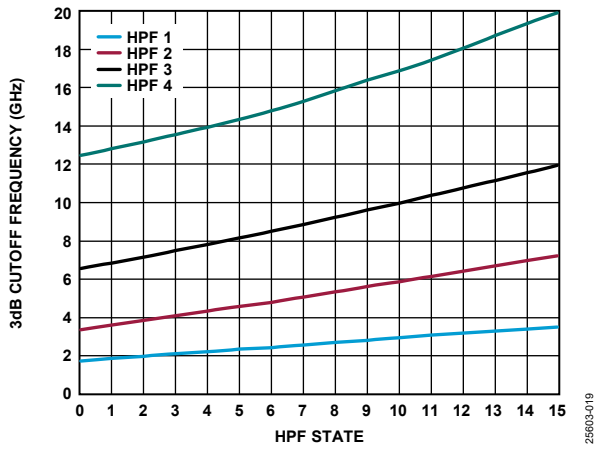

Figure 19. 3 dB Cutoff Frequency vs. HPF State, HPF Configuration

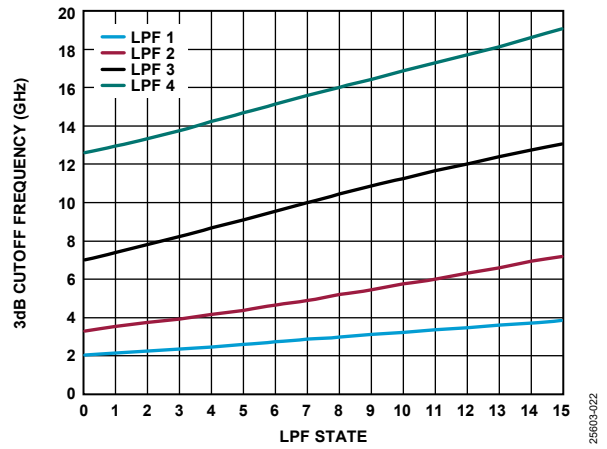

Figure 22. 3 dB Cutoff Frequency vs. LPF State, LPF Configuration

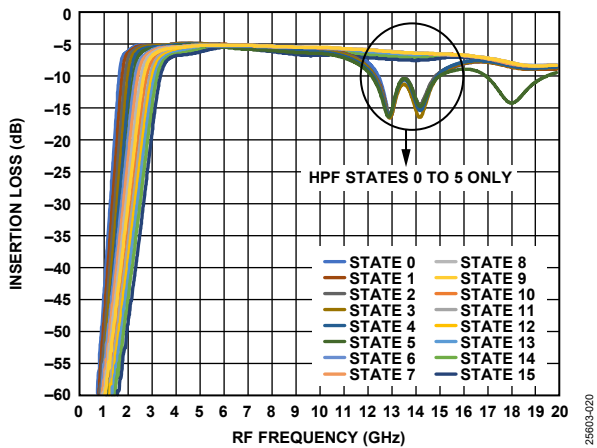

Figure 20. Insertion Loss vs. RF Frequency, HPF 1 Configuration Swept HPF State

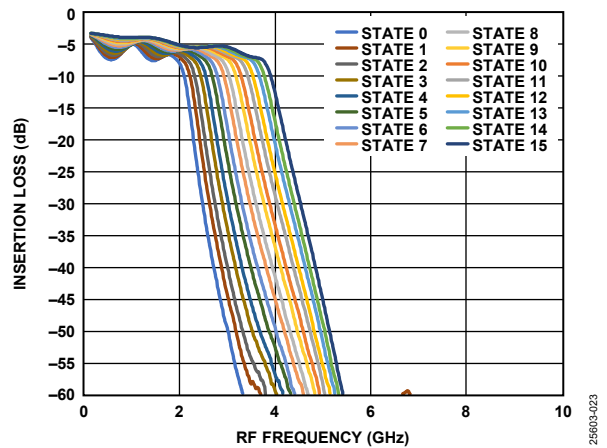

Figure 23. Insertion Loss vs. RF Frequency, LPF 1 Configuration Swept LPF State

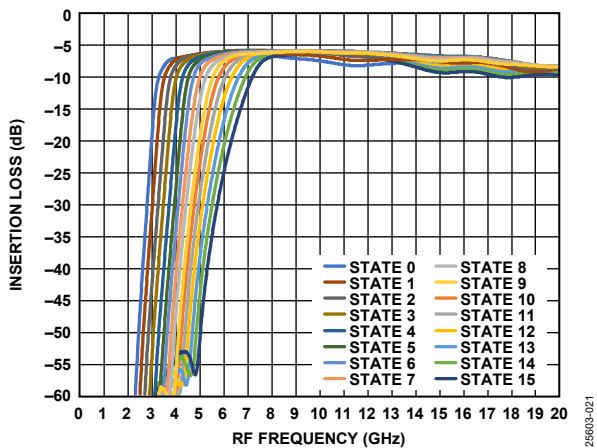

Figure 21. Insertion Loss vs. RF Frequency, HPF 2 Configuration Swept HPF State

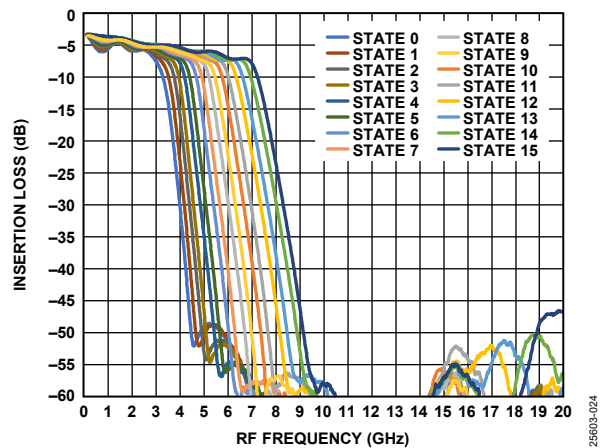

Figure 24. Insertion Loss vs. RF Frequency, LPF 2 Configuration Swept LPF State

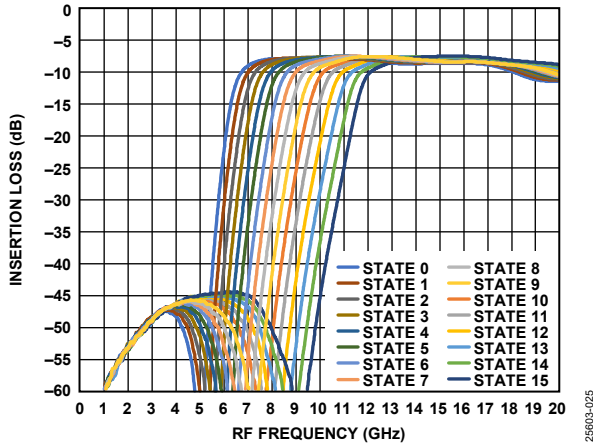

Figure 25. Insertion Loss vs. RF Frequency, HPF 3 Configuration Swept HPF State

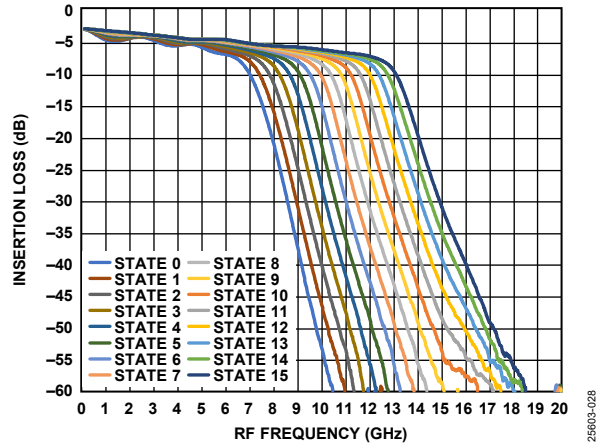

Figure 28. Insertion Loss vs. RF Frequency, LPF 3 Configuration Swept LPF State

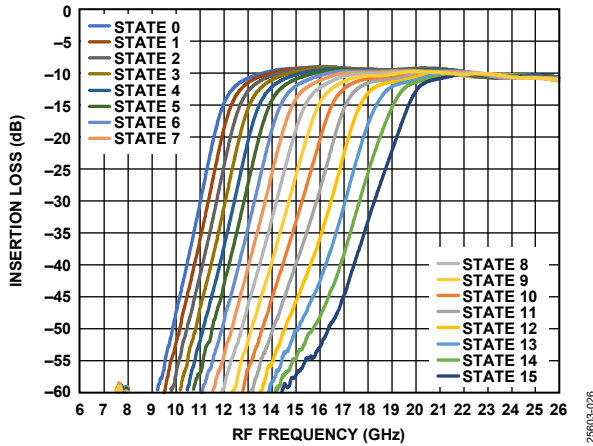

Figure 26. Insertion Loss vs. RF Frequency, HPF 4 Configuration Swept HPF State

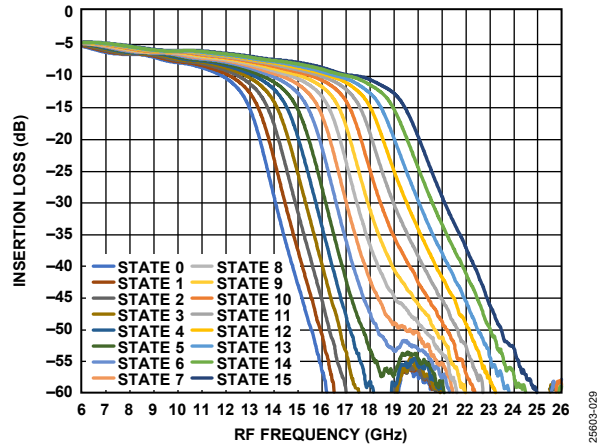

Figure 29. Insertion Loss vs. RF Frequency, LPF 4 Configuration Swept LPF State

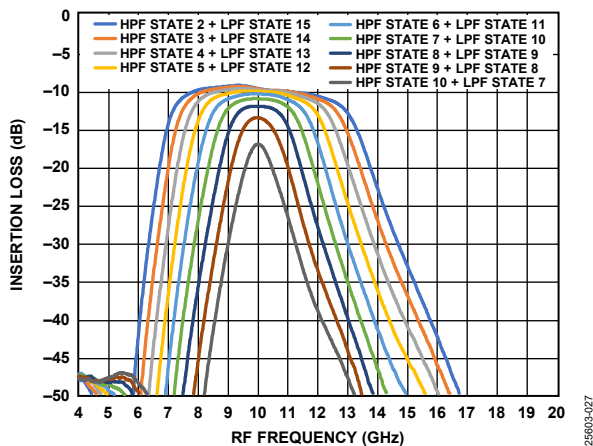

Figure 27. Insertion Loss vs. RF Frequency, Center Frequency (f_{CENTER}) = 10 GHz in Various 3 dB Bandwidth for HPF 3 and LPF 3 Configuration

THEORY OF OPERATION

CHIP ARCHITECTURE

The ADMV8818-EP is a highly flexible filter that can achieve tunable band-pass, high-pass, low-pass, all pass, or all reject responses from 2 GHz to 18 GHz. Due to the flexible architecture of the ADMV8818-EP with four SP5T switches coupled with digitally tunable high-pass and low-pass filter arrays, the device provides full coverage over the frequency band without any dead zones. Figure 1 is a conceptual block diagram of the ADMV8818-EP.

The ADMV8818-EP consists of two sections, the input and the output section. The input section has four high-pass filters and an optional bypass configuration that is selectable by the two SP5T RFIN switches. Similarly, the output section has four low-pass filters and an optional bypass configuration that is selectable by the two SP5T RFOUT switches. Because the input and output sections are independent from one another, the chip can be configured for any combination of high-pass filter, low-pass filter, or bypass configuration.

The two SP5T RFIN switches are controlled simultaneously with a 3-bit digital control. Likewise, the two SP5T RFOUT switches are controlled simultaneously with a 3-bit digital control. This control scheme creates a total of 25 possible combinations of switch settings, achieving many possible filter responses.

Figure 30 shows an example of the signal path when the two SP5T RFIN and two SP5T RFOUT switches are configured for the HPF 1 and LPF 1, respectively. Using this switch setting, a band-pass or a no pass response can be created in the 2 GHz to 3.8 GHz frequency range, depending on the filter settings for the HPF 1 and LPF 1.

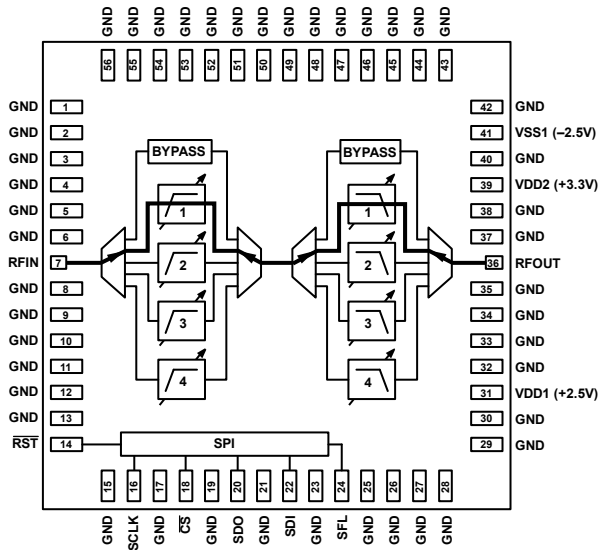

Figure 30. ADMV8818-EP Configured for HPF 1 and LPF 1

Similarly, any of the filters can be bypassed, creating a low-pass or a high-pass response, as shown in Figure 31, where the HPF is bypassed and LPF 3 filter is selected. This configuration enables a tunable LPF response in the 8 GHz to 12 GHz frequency range.

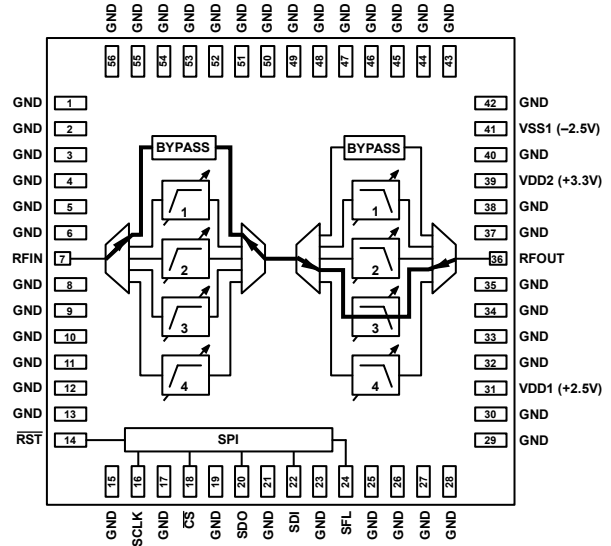

Figure 31. ADMV8818-EP Configured for LPF 3

Moreover, any of the high-pass filters can be coupled with any of the low-pass filters, achieving virtually no dead zones in the 2 GHz to 18 GHz frequency range and a wide band-pass response. Figure 32 shows the conceptual block diagram of ADMV8818-EP when HPF 3 and LPF 2 are selected.

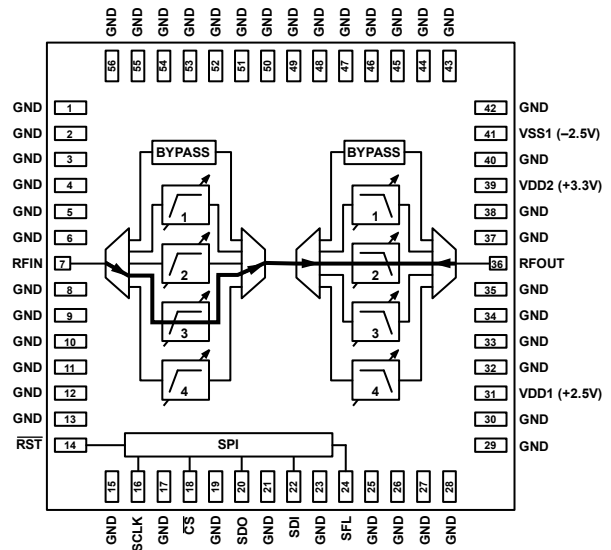

Figure 32. ADMV8818-EP Configured for HPF 3 and LPF 2

TUNABLE HIGH-PASS FILTERS

Figure 33 shows a simplified schematic of the HPF 1, which is a Chebyshev type filter. The f_{3dB} can be adjusted by varying Capacitor C1 to Capacitor C4. These tunable capacitors are constructed with 4-bit digital capacitor arrays, providing 16 distinct values. The step size of these tunable capacitors is adjusted so that each digital binary code increment creates approximately the same increment in the f_{3dB} .

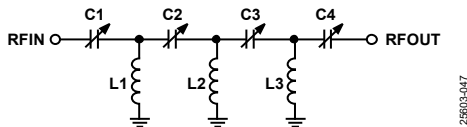

Figure 33. HPF 1 Simplified Schematic

The HPF 2, HPF 3, and HPF 4 filters share the same architecture as the HPF 1 filter. However, the filter order is increased with respect to the frequency to achieve a similar rejection response for all filters.

TUNABLE LOW-PASS FILTERS

Figure 34 shows a simplified schematic of the LPF 1, which is a Chebyshev type filter. The f_{3dB} can be adjusted by varying Capacitor C1 to Capacitor C4. These tunable capacitors are constructed with 4-bit digital capacitor arrays, providing 16 distinct values. The step size of these tunable capacitors is adjusted so that each digital binary code increment creates approximately the same increment in the f_{3dB} .

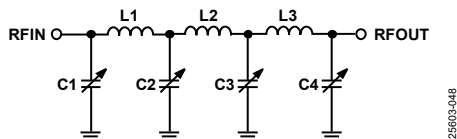

Figure 34. LPF 1 Simplified Schematic

The LPF 2, LPF 3, and LPF 4 filters share the same architecture as the LPF 1 filter. However, the filter order is increased with respect to the frequency to achieve a similar rejection response for all filters.

SPI CONFIGURATION

The SPI of the ADMV8818-EP allows configuration of the device for specific functions or operations via the 5-pin SPI port. This interface provides users with added flexibility and customization. The SPI consists of five control lines: SFL, SCLK, SDI, SDO, and \overline{CS} . For normal SPI operations, keep the SFL pin low.

The SPI protocol consists of an R/W bit followed by 15 register address bits and 8 data bits. The address field and data field are organized MSB first and end with the LSB.

Set the MSB to 0 for a write operation and set the MSB to 1 for a read operation. The write cycle must be sampled on the rising edge of SCLK. The 24 bits of the serial write address and data are shifted in on the SDI control line, MSB to LSB. The ADMV8818-EP input logic level for the write cycle supports a 3.3 V interface.

For a read cycle, the R/W bit and the 15 register address bits shift in on the rising edge of SCLK on the SDI control line. Then, 8 bits of serial read data shift out on the SDO control line, MSB first, on the falling edge of SCLK. The output logic level for a read cycle is 3.3 V. The output drivers of the SDO are enabled after the last rising edge of SCLK of the instruction cycle and remain active until the end of the read cycle. In a read operation, when \overline{CS} is deasserted, SDO returns to high impedance until the

next read transaction. \overline{CS} is active low and must be deasserted at the end of the write or read sequence.

An active low input on \overline{CS} starts and gates a communication cycle. The \overline{CS} pin allows more than one device to be used on the same serial communications lines. The SDO pin goes to a high impedance state when the \overline{CS} input is high. During the communication cycle, the chip select must stay low. The SPI communications protocol follows the Analog Devices SPI standard. For more information, see the [ADI-SPI Serial Control Interface Standard \(Rev 1.0\)](#).

RF CONNECTIONS

The RFIN and RFOUT pins of the ADMV8818-EP are dc-coupled to on-chip RF switches. If a dc voltage is present on the RFIN and RFOUT pins from other components within the system, it is recommended to place dc blocking capacitors in series with these pins. The dc blocking capacitors must be selected based on the operating frequency of the filter. Generally, a value greater than 100 pF is sufficient to minimize insertion loss at the lower frequencies of operation. At higher frequencies of operation, it may be necessary to consider the parasitic elements of the selected capacitor. Figure 35 shows a general model of a capacitor with the parasitic elements. The parasitic series inductance (L_{ESL}) is typically of most concern given that its impedance can become dominant at frequencies above 10 GHz. The other parasitic elements, including the leakage resistance (R_L), the dielectric absorption resistance (R_{DA}), the dielectric absorption capacitance (C_{DA}), and electrical series resistance (R_{ESR}) are less critical elements for consideration but are shown here for completeness.

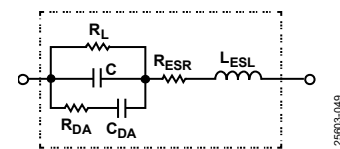

Figure 35. General Model of a Capacitor

MODE SELECTION

The ADMV8818-EP has two modes of operation: SPI write and SPI fast latch. SPI write mode is the normal operating mode, whereas SPI fast latch mode is used to sequence through the on-chip lookup table (LUT) using the internal state machine. To select SPI write mode, set the SFL pin low. For operation in SPI fast latch mode, program the on-chip lookup table and fast latch parameters with the SFL pin low, and then bring the SFL pin high to enter this mode. Figure 36 shows a simplified representation of the SPI with the register map and internal state machine.

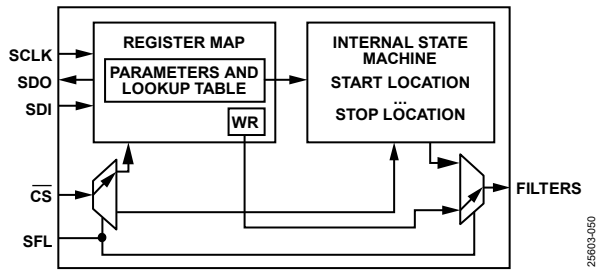

Figure 36. Simplified SPI Diagram

SPI WRITE MODE

SPI write mode has five write groupings, WR0 through WR4 in Register 0x020 through Register 0x029. The groupings can be thought of as a small lookup table for SPI write mode. Each grouping consists of the following:

- RFIN switch position
- RFIN switch set
- RFOUT switch position
- RFOUT switch set
- HPF state
- LPF state

See the Register Details section for an example of the write grouping of WR0 (Register 0x020 and Register 0x021).

SWITCH POSITIONS

The RFIN switch position dictates where the HPF state bits are assigned, and the RFOUT switch position dictates where the LPF state bits are assigned. For example, in the WR0_SW write group (Register 0x020), when SW_IN_WR0 is set for Band 1 and SW_OUT_WR0 is set for Band 2, HPF_WR0 and LPF_WR0 (Register 0x021) are applied to HPF 1 and LPF 2, respectively.

SWITCH SET

The RFIN switch set bit is used to determine if the RFIN switch position is moved to that setting. Similarly, the RFOUT switch set bit is used to determine if the RFOUT switch position is moved to that setting. This functionality is useful for configuring a filter to a known state and leaving the switch position unchanged (switch set bits low). For most applications, the switch set bits are high.

FILTER SETTINGS

Each high-pass filter and low-pass filter contains 16 states (4 bits). A value of zero corresponds to setting the f_{3dB} of the filter to its lowest possible frequency. Conversely, a value of 15 corresponds to setting the f_{3dB} of the filter to its highest possible frequency.

WRITE GROUP PRIORITY

In SPI write mode, because there are five write groupings, it is possible that multiple RFIN switch set bits or RFOUT switch set bits are high. The behavior of the switches depends on the type of SPI transaction, either streaming or single instruction.

In general, there are two types of SPI streaming transactions, Endian register ascending order and descending order. The ADMV8818-EP supports the ascending order only. To enable

SPI streaming with Endian register ascending order, program Register 0x000 to 0x3C.

For SPI streaming transactions (recommended), the priority order for the RFIN switch set bits and the RFOUT switch set bits is WR0 to WR4.

The SPI streaming transaction for Register 0x020 to Register 0x029 then points to Address 0x020 and streams out 10 bytes of data. The SPI streaming transaction is 96 bits in total (R/W bit + 15 address bits + 80 data bits).

An example of the priority order for an SPI streaming transaction follows: if the switch set bits are high for both WR1 and WR2, the resulting switch positions are the positions programmed in WR1.

For SPI single instruction transactions, the most recently programmed RFIN switch set and RFOUT switch set takes effect to move the switch positions. To use SPI single instruction transactions, the switch register must be written first followed by the filter setting register. For example, to use write grouping WR0, Register 0x020 is written first using a 24-bit transaction (R/W bit + 15 address bits + 8 data bits, followed by writing Register 0x021 also using a 24-bit transaction.

FREQUENCY TERMINOLOGY

Because the ADMV8818-EP is designed to operate over a wide frequency range, there is frequency dependent insertion loss that results in a negative slope vs. frequency. Additionally, depending upon the selected filter and the state, there may also be ripple within the pass band. Given these characteristics, a proper definition is necessary to establish a reference frequency (f_{REF}) from which the f_{3dB} for each filter can be computed.

Analog Devices has found that a consistent methodology for determining the f_{REF} and f_{3dB} is to rely on the group delay performance of a filter. The following is the methodology used for determining the ADMV8818-EP specifications:

1. Find the peak group delay (GD_{PEAK}) and peak group delay frequency (f_{PEAK}) as the filter insertion loss (S_{21}) begins to roll off.
2. For a low-pass filter, divide f_{PEAK} by 2 to find the average frequency (f_{AVG}). For a high-pass filter, multiply f_{PEAK} by 2. Once f_{AVG} is calculated, determine the group delay at this frequency. Generally, the group delay is flat and approximately equal to the average at this particular frequency (f_{AVG}).
3. Take the mathematical mean of the group delay from Step 1 and Step 2 to find the reference group delay (GD_{REF}), and then find the corresponding f_{REF} and reference insertion loss (IL_{REF}) for this group delay.
4. Subtract 3 dB from the IL_{REF} to find the 3 dB insertion loss (IL_{3dB}), and then find the corresponding f_{3dB} .

SPI FAST LATCH MODE

The ADMV8818-EP has a 128 state lookup table and an internal state machine that is useful for quickly changing filter states in SPI fast latch mode. When the SFL pin is high, SPI fast

latch mode is enabled, and the internal state machine sequences on each rising edge of the $\overline{\text{CS}}$ pin.

The lookup table has 128 groupings, LUT0 through LUT127, in Register 0x100 through Register 0x1FF. Each grouping consists of the same type of parameters as those of SPI write mode.

The functionality of the switch positions and filter state bits for SPI fast latch mode is similar to those of SPI write mode. That is, the filter state bits are assigned based on the switch position bits. However, the switch set parameters do not contain any priority. If the RFIN switch set bits and RFOUT switch set bits are enabled for a particular LUT, the switch positions change.

The functionality of the internal state machine is such that on each rising edge of the $\overline{\text{CS}}$ pin, the internal state machine sequences a pointer based on the programmed direction. The internal state machine has the following parameters:

- FAST_LATCH_POINTER (Register 0x010)
- FAST_LATCH_LOAD (Register 0x010)
- FAST_LATCH_STOP (Register 0x011)
- FAST_LATCH_START (Register 0x012)
- FAST_LATCH_DIRECTION (Register 0x013)
- FAST_LATCH_STATE (Register 0x014)

The FAST_LATCH_STATE is the next LUT grouping that is selected on the next rising edge of the $\overline{\text{CS}}$ pin. The FAST_LATCH_STATE is considered the internal pointer location.

The internal pointer location can be changed by using the FAST_LATCH_LOAD and FAST_LATCH_POINTER bits. When the FAST_LATCH_LOAD bit is set high, the FAST_LATCH_POINTER value is loaded into the internal pointer. The FAST_LATCH_LOAD bit is self resetting after the load operation completes.

When the FAST_LATCH_DIRECTION bit is set to zero, the sequencing direction is incremental. When the FAST_LATCH_DIRECTION bit is set to one, the sequencing direction is decremental.

The FAST_LATCH_START and FAST_LATCH_STOP bits are used to set the start and stop location, respectively. For incremental direction, the internal state machine sequences from the start location to the stop location and then rolls over to the start location. For the decremental direction, the sequence is from the stop location to the start location and then rolls over to the stop location.

The FAST_LATCH_STATE value can fall outside of the start and stop locations, which occurs if the start and stop locations are updated and the internal pointer is left unchanged from its prior value. If this situation occurs, additional LUT groupings are selected before the FAST_LATCH_STATE value eventually falls within the start and stop locations. For example, if the FAST_LATCH_STATE value is 12, the direction is incremental, the start location is 15, and the stop location is 31, the LUT groupings selected on the next six rising edges of the $\overline{\text{CS}}$ pin are the LUT grouping numbers, 12, 13, 14, 15, 16, and 17.

CHIP RESET

There are two methods that can be used to reset the ADMV8818-EP registers to their default power-on state, a hard reset and a soft reset. The hard reset utilizes the RST pin, and the soft reset utilizes Register 0x000.

To perform a hard reset, momentarily bring the $\overline{\text{RST}}$ pin low and then high. See Figure 2 for the minimum required duration time for the RST pin to be low.

To perform a soft reset, program Register 0x000 to a value of 0x81. This action sets the SOFTRESET and SOFTRESET_ bits high to initiate the reset. The SOFTRESET and SOFTRESET_ bits are self resetting once the reset operation is complete.

Regardless of the reset method used, it is recommended to perform the following after the chip resets:

- Program Register 0x000 to 0x3C to enable the SDO pin and allow SPI streaming with Endian ascending order.
- Read back all registers on the chip.

APPLICATIONS INFORMATION

PCB DESIGN GUIDELINES

The PCB used to implement the ADMV8818-EP must use a high quality dielectric material between the top metallization layer and internal ground layer, such as the Rogers 4003 or the Rogers 4350. All other dielectric layers of the PCB can be standard material, such as the Isola 370HR. The characteristic impedance

of the transmission lines to the RFIN and RFOUT pins of the ADMV8818-EP must be carefully controlled to 50 Ω to ensure optimal RF performance. Connect the GND pins and exposed pads of the ADMV8818-EP directly to the ground plane of the PCB. Use a sufficient number of via holes to connect the top and bottom ground planes of the PCB.

PROGRAMMING FLOW CHART

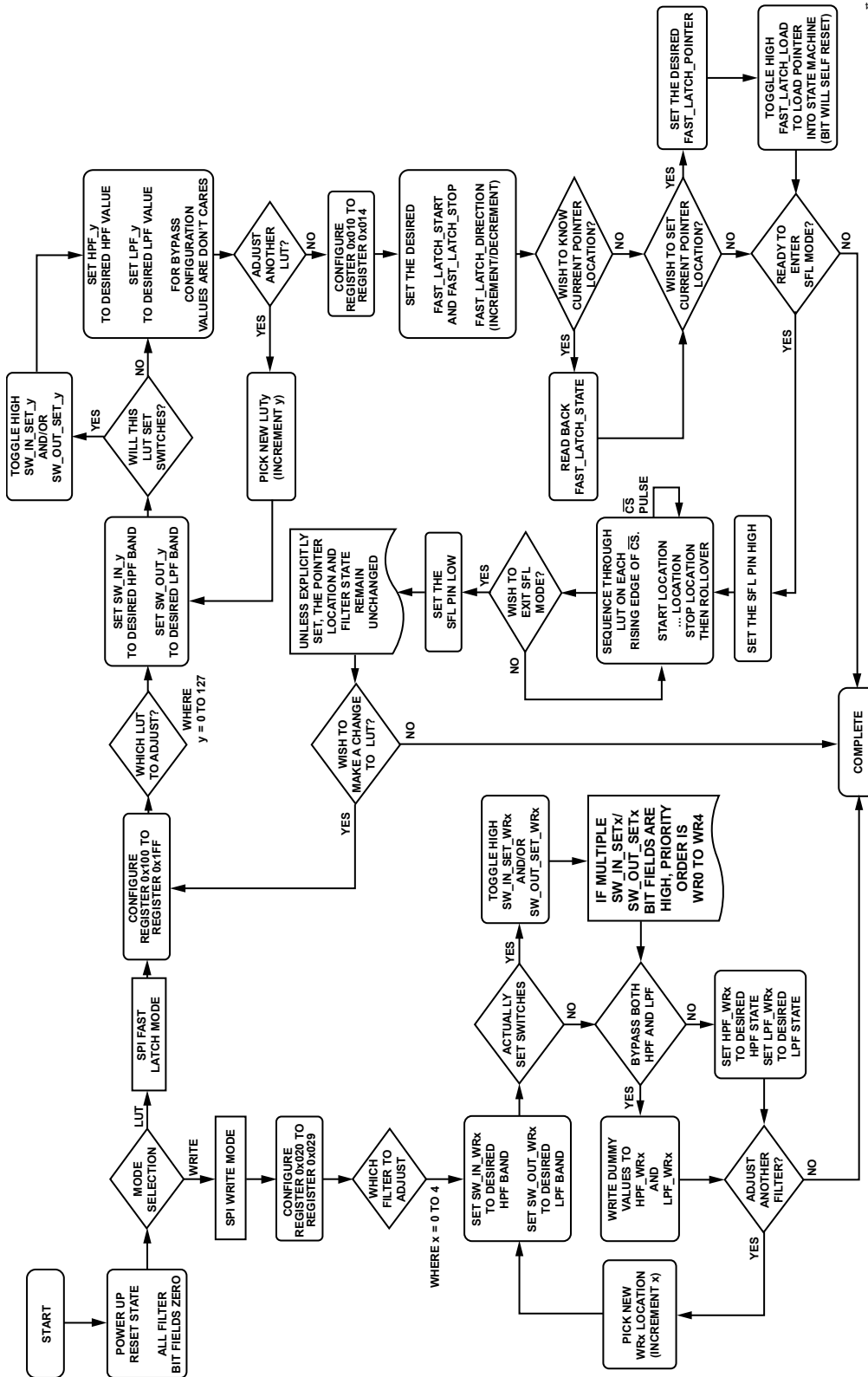

25803-054

NOTES
1. SPI WRITE MODE SWITCH PRIORITY ORDER ASSUMES SPI STREAMING TRANSACTION FOR REGISTER 0x020 TO REGISTER 0x029.

Figure 37. Programming Flow Chart

REGISTER SUMMARY

Table 6. ADMV8818-EP Register Summary

Reg	Name	Bits	Bit 7	Bit 6	Bit 5	Bit 4	Bit 3	Bit 2	Bit 1	Bit 0	Reset	R/W	
0x000	ADL_SPI_CONFIG_A	[7:0]	SOFTRESET_	LSB_FIRST_	ENDIAN_	SDOACTIVE_	SDOACTIVE	ENDIAN	LSB_FIRST	SOFTRESET	0x00	R/W	
0x001	ADL_SPI_CONFIG_B	[7:0]	SINGLE_INSTRUCTION	CSB_STALL	MASTER_SLAVE_RB	RESERVED				MASTER_SLAVE_TRANSFER	0x00	R/W	
0x003	CHIPTYPE	[7:0]	CHIPTYPE									0x01	R
0x004	PRODUCT_ID_L	[7:0]	PRODUCT_ID_L									0x18	R
0x005	PRODUCT_ID_H	[7:0]	PRODUCT_ID_H									0x88	R
0x010	FAST_LATCH_POINTER	[7:0]	FAST_LATCH_LOAD	FAST_LATCH_POINTER								0x00	R/W
0x011	FAST_LATCH_STOP	[7:0]	RESERVED	FAST_LATCH_STOP								0x7F	R/W
0x012	FAST_LATCH_START	[7:0]	RESERVED	FAST_LATCH_START								0x00	R/W
0x013	FAST_LATCH_DIRECTION	[7:0]	RESERVED							FAST_LATCH_DIRECTION		0x00	R/W
0x014	FAST_LATCH_STATE	[7:0]	RESERVED	FAST_LATCH_STATE								0x00	R
0x020	WR0_SW	[7:0]	SW_IN_SET_WR0	SW_OUT_SET_WR0	SW_IN_WR0			SW_OUT_WR0			0x00	R/W	
0x021	WR0_FILTER	[7:0]	HPF_WR0				LPF_WR0				0x00	R/W	
0x022	WR1_SW	[7:0]	SW_IN_SET_WR1	SW_OUT_SET_WR1	SW_IN_WR1			SW_OUT_WR1			0x00	R/W	
0x023	WR1_FILTER	[7:0]	HPF_WR1				LPF_WR1				0x00	R/W	
0x024	WR2_SW	[7:0]	SW_IN_SET_WR2	SW_OUT_SET_WR2	SW_IN_WR2			SW_OUT_WR2			0x00	R/W	
0x025	WR2_FILTER	[7:0]	HPF_WR2				LPF_WR2				0x00	R/W	
0x026	WR3_SW	[7:0]	SW_IN_SET_WR3	SW_OUT_SET_WR3	SW_IN_WR3			SW_OUT_WR3			0x00	R/W	
0x027	WR3_FILTER	[7:0]	HPF_WR3				LPF_WR3				0x00	R/W	
0x028	WR4_SW	[7:0]	SW_IN_SET_WR4	SW_OUT_SET_WR4	SW_IN_WR4			SW_OUT_WR4			0x00	R/W	
0x029	WR4_FILTER	[7:0]	HPF_WR4				LPF_WR4				0x00	R/W	
0x100	LUT0_SW	[7:0]	SW_IN_SET_0	SW_OUT_SET_0	SW_IN_0			SW_OUT_0			0x00	R/W	
0x101	LUT0_FILTER	[7:0]	HPF_0				LPF_0				0x00	R/W	
0x102	LUT1_SW	[7:0]	SW_IN_SET_1	SW_OUT_SET_1	SW_IN_1			SW_OUT_1			0x00	R/W	
0x103	LUT1_FILTER	[7:0]	HPF_1				LPF_1				0x00	R/W	
0x104	LUT2_SW	[7:0]	SW_IN_SET_2	SW_OUT_SET_2	SW_IN_2			SW_OUT_2			0x00	R/W	
0x105	LUT2_FILTER	[7:0]	HPF_2				LPF_2				0x00	R/W	
0x106	LUT3_SW	[7:0]	SW_IN_SET_3	SW_OUT_SET_3	SW_IN_3			SW_OUT_3			0x00	R/W	
0x107	LUT3_FILTER	[7:0]	HPF_3				LPF_3				0x00	R/W	
0x108	LUT4_SW	[7:0]	SW_IN_SET_4	SW_OUT_SET_4	SW_IN_4			SW_OUT_4			0x00	R/W	
0x109	LUT4_FILTER	[7:0]	HPF_4				LPF_4				0x00	R/W	
0x10A	LUT5_SW	[7:0]	SW_IN_SET_5	SW_OUT_SET_5	SW_IN_5			SW_OUT_5			0x00	R/W	
0x10B	LUT5_FILTER	[7:0]	HPF_5				LPF_5				0x00	R/W	
0x10C	LUT6_SW	[7:0]	SW_IN_SET_6	SW_OUT_SET_6	SW_IN_6			SW_OUT_6			0x00	R/W	
0x10D	LUT6_FILTER	[7:0]	HPF_6				LPF_6				0x00	R/W	
0x10E	LUT7_SW	[7:0]	SW_IN_SET_7	SW_OUT_SET_7	SW_IN_7			SW_OUT_7			0x00	R/W	
0x10F	LUT7_FILTER	[7:0]	HPF_7				LPF_7				0x00	R/W	
0x110	LUT8_SW	[7:0]	SW_IN_SET_8	SW_OUT_SET_8	SW_IN_8			SW_OUT_8			0x00	R/W	
0x111	LUT8_FILTER	[7:0]	HPF_8				LPF_8				0x00	R/W	
0x112	LUT9_SW	[7:0]	SW_IN_SET_9	SW_OUT_SET_9	SW_IN_9			SW_OUT_9			0x00	R/W	
0x113	LUT9_FILTER	[7:0]	HPF_9				LPF_9				0x00	R/W	

Reg	Name	Bits	Bit 7	Bit 6	Bit 5	Bit 4	Bit 3	Bit 2	Bit 1	Bit 0	Reset	R/W
0x114	LUT10_SW	[7:0]	SW_IN_SET_10	SW_OUT_SET_10	SW_IN_10			SW_OUT_10			0x00	R/W
0x115	LUT10_FILTER	[7:0]	HPF_10				LPF_10				0x00	R/W
0x116	LUT11_SW	[7:0]	SW_IN_SET_11	SW_OUT_SET_11	SW_IN_11			SW_OUT_11			0x00	R/W
0x117	LUT11_FILTER	[7:0]	HPF_11				LPF_11				0x00	R/W
0x118	LUT12_SW	[7:0]	SW_IN_SET_12	SW_OUT_SET_12	SW_IN_12			SW_OUT_12			0x00	R/W
0x119	LUT12_FILTER	[7:0]	HPF_12				LPF_12				0x00	R/W
0x11A	LUT13_SW	[7:0]	SW_IN_SET_13	SW_OUT_SET_13	SW_IN_13			SW_OUT_13			0x00	R/W
0x11B	LUT13_FILTER	[7:0]	HPF_13				LPF_13				0x00	R/W
0x11C	LUT14_SW	[7:0]	SW_IN_SET_14	SW_OUT_SET_14	SW_IN_14			SW_OUT_14			0x00	R/W
0x11D	LUT14_FILTER	[7:0]	HPF_14				LPF_14				0x00	R/W
0x11E	LUT15_SW	[7:0]	SW_IN_SET_15	SW_OUT_SET_15	SW_IN_15			SW_OUT_15			0x00	R/W
0x11F	LUT15_FILTER	[7:0]	HPF_15				LPF_15				0x00	R/W
0x120	LUT16_SW	[7:0]	SW_IN_SET_16	SW_OUT_SET_16	SW_IN_16			SW_OUT_16			0x00	R/W
0x121	LUT16_FILTER	[7:0]	HPF_16				LPF_16				0x00	R/W
0x122	LUT17_SW	[7:0]	SW_IN_SET_17	SW_OUT_SET_17	SW_IN_17			SW_OUT_17			0x00	R/W
0x123	LUT17_FILTER	[7:0]	HPF_17				LPF_17				0x00	R/W
0x124	LUT18_SW	[7:0]	SW_IN_SET_18	SW_OUT_SET_18	SW_IN_18			SW_OUT_18			0x00	R/W
0x125	LUT18_FILTER	[7:0]	HPF_18				LPF_18				0x00	R/W
0x126	LUT19_SW	[7:0]	SW_IN_SET_19	SW_OUT_SET_19	SW_IN_19			SW_OUT_19			0x00	R/W
0x127	LUT19_FILTER	[7:0]	HPF_19				LPF_19				0x00	R/W
0x128	LUT20_SW	[7:0]	SW_IN_SET_20	SW_OUT_SET_20	SW_IN_20			SW_OUT_20			0x00	R/W
0x129	LUT20_FILTER	[7:0]	HPF_20				LPF_20				0x00	R/W
0x12A	LUT21_SW	[7:0]	SW_IN_SET_21	SW_OUT_SET_21	SW_IN_21			SW_OUT_21			0x00	R/W
0x12B	LUT21_FILTER	[7:0]	HPF_21				LPF_21				0x00	R/W
0x12C	LUT22_SW	[7:0]	SW_IN_SET_22	SW_OUT_SET_22	SW_IN_22			SW_OUT_22			0x00	R/W
0x12D	LUT22_FILTER	[7:0]	HPF_22				LPF_22				0x00	R/W
0x12E	LUT23_SW	[7:0]	SW_IN_SET_23	SW_OUT_SET_23	SW_IN_23			SW_OUT_23			0x00	R/W
0x12F	LUT23_FILTER	[7:0]	HPF_23				LPF_23				0x00	R/W
0x130	LUT24_SW	[7:0]	SW_IN_SET_24	SW_OUT_SET_24	SW_IN_24			SW_OUT_24			0x00	R/W
0x131	LUT24_FILTER	[7:0]	HPF_24				LPF_24				0x00	R/W
0x132	LUT25_SW	[7:0]	SW_IN_SET_25	SW_OUT_SET_25	SW_IN_25			SW_OUT_25			0x00	R/W
0x133	LUT25_FILTER	[7:0]	HPF_25				LPF_25				0x00	R/W
0x134	LUT26_SW	[7:0]	SW_IN_SET_26	SW_OUT_SET_26	SW_IN_26			SW_OUT_26			0x00	R/W
0x135	LUT26_FILTER	[7:0]	HPF_26				LPF_26				0x00	R/W
0x136	LUT27_SW	[7:0]	SW_IN_SET_27	SW_OUT_SET_27	SW_IN_27			SW_OUT_27			0x00	R/W
0x137	LUT27_FILTER	[7:0]	HPF_27				LPF_27				0x00	R/W
0x138	LUT28_SW	[7:0]	SW_IN_SET_28	SW_OUT_SET_28	SW_IN_28			SW_OUT_28			0x00	R/W
0x139	LUT28_FILTER	[7:0]	HPF_28				LPF_28				0x00	R/W
0x13A	LUT29_SW	[7:0]	SW_IN_SET_29	SW_OUT_SET_29	SW_IN_29			SW_OUT_29			0x00	R/W
0x13B	LUT29_FILTER	[7:0]	HPF_29				LPF_29				0x00	R/W
0x13C	LUT30_SW	[7:0]	SW_IN_SET_30	SW_OUT_SET_30	SW_IN_30			SW_OUT_30			0x00	R/W
0x13D	LUT30_FILTER	[7:0]	HPF_30				LPF_30				0x00	R/W
0x13E	LUT31_SW	[7:0]	SW_IN_SET_31	SW_OUT_SET_31	SW_IN_31			SW_OUT_31			0x00	R/W
0x13F	LUT31_FILTER	[7:0]	HPF_31				LPF_31				0x00	R/W
0x140	LUT32_SW	[7:0]	SW_IN_SET_32	SW_OUT_SET_32	SW_IN_32			SW_OUT_32			0x00	R/W
0x141	LUT32_FILTER	[7:0]	HPF_32				LPF_32				0x00	R/W

Reg	Name	Bits	Bit 7	Bit 6	Bit 5	Bit 4	Bit 3	Bit 2	Bit 1	Bit 0	Reset	R/W	
0x142	LUT33_SW	[7:0]	SW_IN_SET_33	SW_OUT_SET_33	SW_IN_33			SW_OUT_33			0x00	R/W	
0x143	LUT33_FILTER	[7:0]	HPF_33						LPF_33			0x00	R/W
0x144	LUT34_SW	[7:0]	SW_IN_SET_34	SW_OUT_SET_34	SW_IN_34			SW_OUT_34			0x00	R/W	
0x145	LUT34_FILTER	[7:0]	HPF_34						LPF_34			0x00	R/W
0x146	LUT35_SW	[7:0]	SW_IN_SET_35	SW_OUT_SET_35	SW_IN_35			SW_OUT_35			0x00	R/W	
0x147	LUT35_FILTER	[7:0]	HPF_35						LPF_35			0x00	R/W
0x148	LUT36_SW	[7:0]	SW_IN_SET_36	SW_OUT_SET_36	SW_IN_36			SW_OUT_36			0x00	R/W	
0x149	LUT36_FILTER	[7:0]	HPF_36						LPF_36			0x00	R/W
0x14A	LUT37_SW	[7:0]	SW_IN_SET_37	SW_OUT_SET_37	SW_IN_37			SW_OUT_37			0x00	R/W	
0x14B	LUT37_FILTER	[7:0]	HPF_37						LPF_37			0x00	R/W
0x14C	LUT38_SW	[7:0]	SW_IN_SET_38	SW_OUT_SET_38	SW_IN_38			SW_OUT_38			0x00	R/W	
0x14D	LUT38_FILTER	[7:0]	HPF_38						LPF_38			0x00	R/W
0x14E	LUT39_SW	[7:0]	SW_IN_SET_39	SW_OUT_SET_39	SW_IN_39			SW_OUT_39			0x00	R/W	
0x14F	LUT39_FILTER	[7:0]	HPF_39						LPF_39			0x00	R/W
0x150	LUT40_SW	[7:0]	SW_IN_SET_40	SW_OUT_SET_40	SW_IN_40			SW_OUT_40			0x00	R/W	
0x151	LUT40_FILTER	[7:0]	HPF_40						LPF_40			0x00	R/W
0x152	LUT41_SW	[7:0]	SW_IN_SET_41	SW_OUT_SET_41	SW_IN_41			SW_OUT_41			0x00	R/W	
0x153	LUT41_FILTER	[7:0]	HPF_41						LPF_41			0x00	R/W
0x154	LUT42_SW	[7:0]	SW_IN_SET_42	SW_OUT_SET_42	SW_IN_42			SW_OUT_42			0x00	R/W	
0x155	LUT42_FILTER	[7:0]	HPF_42						LPF_42			0x00	R/W
0x156	LUT43_SW	[7:0]	SW_IN_SET_43	SW_OUT_SET_43	SW_IN_43			SW_OUT_43			0x00	R/W	
0x157	LUT43_FILTER	[7:0]	HPF_43						LPF_43			0x00	R/W
0x158	LUT44_SW	[7:0]	SW_IN_SET_44	SW_OUT_SET_44	SW_IN_44			SW_OUT_44			0x00	R/W	
0x159	LUT44_FILTER	[7:0]	HPF_44						LPF_44			0x00	R/W
0x15A	LUT45_SW	[7:0]	SW_IN_SET_45	SW_OUT_SET_45	SW_IN_45			SW_OUT_45			0x00	R/W	
0x15B	LUT45_FILTER	[7:0]	HPF_45						LPF_45			0x00	R/W
0x15C	LUT46_SW	[7:0]	SW_IN_SET_46	SW_OUT_SET_46	SW_IN_46			SW_OUT_46			0x00	R/W	
0x15D	LUT46_FILTER	[7:0]	HPF_46						LPF_46			0x00	R/W
0x15E	LUT47_SW	[7:0]	SW_IN_SET_47	SW_OUT_SET_47	SW_IN_47			SW_OUT_47			0x00	R/W	
0x15F	LUT47_FILTER	[7:0]	HPF_47						LPF_47			0x00	R/W
0x160	LUT48_SW	[7:0]	SW_IN_SET_48	SW_OUT_SET_48	SW_IN_48			SW_OUT_48			0x00	R/W	
0x161	LUT48_FILTER	[7:0]	HPF_48						LPF_48			0x00	R/W
0x162	LUT49_SW	[7:0]	SW_IN_SET_49	SW_OUT_SET_49	SW_IN_49			SW_OUT_49			0x00	R/W	
0x163	LUT49_FILTER	[7:0]	HPF_49						LPF_49			0x00	R/W
0x164	LUT50_SW	[7:0]	SW_IN_SET_50	SW_OUT_SET_50	SW_IN_50			SW_OUT_50			0x00	R/W	
0x165	LUT50_FILTER	[7:0]	HPF_50						LPF_50			0x00	R/W
0x166	LUT51_SW	[7:0]	SW_IN_SET_51	SW_OUT_SET_51	SW_IN_51			SW_OUT_51			0x00	R/W	
0x167	LUT51_FILTER	[7:0]	HPF_51						LPF_51			0x00	R/W
0x168	LUT52_SW	[7:0]	SW_IN_SET_52	SW_OUT_SET_52	SW_IN_52			SW_OUT_52			0x00	R/W	
0x169	LUT52_FILTER	[7:0]	HPF_52						LPF_52			0x00	R/W
0x16A	LUT53_SW	[7:0]	SW_IN_SET_53	SW_OUT_SET_53	SW_IN_53			SW_OUT_53			0x00	R/W	
0x16B	LUT53_FILTER	[7:0]	HPF_53						LPF_53			0x00	R/W
0x16C	LUT54_SW	[7:0]	SW_IN_SET_54	SW_OUT_SET_54	SW_IN_54			SW_OUT_54			0x00	R/W	
0x16D	LUT54_FILTER	[7:0]	HPF_54						LPF_54			0x00	R/W
0x16E	LUT55_SW	[7:0]	SW_IN_SET_55	SW_OUT_SET_55	SW_IN_55			SW_OUT_55			0x00	R/W	
0x16F	LUT55_FILTER	[7:0]	HPF_55						LPF_55			0x00	R/W

Reg	Name	Bits	Bit 7	Bit 6	Bit 5	Bit 4	Bit 3	Bit 2	Bit 1	Bit 0	Reset	R/W
0x170	LUT56_SW	[7:0]	SW_IN_SET_56	SW_OUT_SET_56	SW_IN_56		SW_OUT_56			0x00	R/W	
0x171	LUT56_FILTER	[7:0]	HPF_56				LPF_56				0x00	R/W
0x172	LUT57_SW	[7:0]	SW_IN_SET_57	SW_OUT_SET_57	SW_IN_57		SW_OUT_57			0x00	R/W	
0x173	LUT57_FILTER	[7:0]	HPF_57				LPF_57				0x00	R/W
0x174	LUT58_SW	[7:0]	SW_IN_SET_58	SW_OUT_SET_58	SW_IN_58		SW_OUT_58			0x00	R/W	
0x175	LUT58_FILTER	[7:0]	HPF_58				LPF_58				0x00	R/W
0x176	LUT59_SW	[7:0]	SW_IN_SET_59	SW_OUT_SET_59	SW_IN_59		SW_OUT_59			0x00	R/W	
0x177	LUT59_FILTER	[7:0]	HPF_59				LPF_59				0x00	R/W
0x178	LUT60_SW	[7:0]	SW_IN_SET_60	SW_OUT_SET_60	SW_IN_60		SW_OUT_60			0x00	R/W	
0x179	LUT60_FILTER	[7:0]	HPF_60				LPF_60				0x00	R/W
0x17A	LUT61_SW	[7:0]	SW_IN_SET_61	SW_OUT_SET_61	SW_IN_61		SW_OUT_61			0x00	R/W	
0x17B	LUT61_FILTER	[7:0]	HPF_61				LPF_61				0x00	R/W
0x17C	LUT62_SW	[7:0]	SW_IN_SET_62	SW_OUT_SET_62	SW_IN_62		SW_OUT_62			0x00	R/W	
0x17D	LUT62_FILTER	[7:0]	HPF_62				LPF_62				0x00	R/W
0x17E	LUT63_SW	[7:0]	SW_IN_SET_63	SW_OUT_SET_63	SW_IN_63		SW_OUT_63			0x00	R/W	
0x17F	LUT63_FILTER	[7:0]	HPF_63				LPF_63				0x00	R/W
0x180	LUT64_SW	[7:0]	SW_IN_SET_64	SW_OUT_SET_64	SW_IN_64		SW_OUT_64			0x00	R/W	
0x181	LUT64_FILTER	[7:0]	HPF_64				LPF_64				0x00	R/W
0x182	LUT65_SW	[7:0]	SW_IN_SET_65	SW_OUT_SET_65	SW_IN_65		SW_OUT_65			0x00	R/W	
0x183	LUT65_FILTER	[7:0]	HPF_65				LPF_65				0x00	R/W
0x184	LUT66_SW	[7:0]	SW_IN_SET_66	SW_OUT_SET_66	SW_IN_66		SW_OUT_66			0x00	R/W	
0x185	LUT66_FILTER	[7:0]	HPF_66				LPF_66				0x00	R/W
0x186	LUT67_SW	[7:0]	SW_IN_SET_67	SW_OUT_SET_67	SW_IN_67		SW_OUT_67			0x00	R/W	
0x187	LUT67_FILTER	[7:0]	HPF_67				LPF_67				0x00	R/W
0x188	LUT68_SW	[7:0]	SW_IN_SET_68	SW_OUT_SET_68	SW_IN_68		SW_OUT_68			0x00	R/W	
0x189	LUT68_FILTER	[7:0]	HPF_68				LPF_68				0x00	R/W
0x18A	LUT69_SW	[7:0]	SW_IN_SET_69	SW_OUT_SET_69	SW_IN_69		SW_OUT_69			0x00	R/W	
0x18B	LUT69_FILTER	[7:0]	HPF_69				LPF_69				0x00	R/W
0x18C	LUT70_SW	[7:0]	SW_IN_SET_70	SW_OUT_SET_70	SW_IN_70		SW_OUT_70			0x00	R/W	
0x18D	LUT70_FILTER	[7:0]	HPF_70				LPF_70				0x00	R/W
0x18E	LUT71_SW	[7:0]	SW_IN_SET_71	SW_OUT_SET_71	SW_IN_71		SW_OUT_71			0x00	R/W	
0x18F	LUT71_FILTER	[7:0]	HPF_71				LPF_71				0x00	R/W
0x190	LUT72_SW	[7:0]	SW_IN_SET_72	SW_OUT_SET_72	SW_IN_72		SW_OUT_72			0x00	R/W	
0x191	LUT72_FILTER	[7:0]	HPF_72				LPF_72				0x00	R/W
0x192	LUT73_SW	[7:0]	SW_IN_SET_73	SW_OUT_SET_73	SW_IN_73		SW_OUT_73			0x00	R/W	
0x193	LUT73_FILTER	[7:0]	HPF_73				LPF_73				0x00	R/W
0x194	LUT74_SW	[7:0]	SW_IN_SET_74	SW_OUT_SET_74	SW_IN_74		SW_OUT_74			0x00	R/W	
0x195	LUT74_FILTER	[7:0]	HPF_74				LPF_74				0x00	R/W
0x196	LUT75_SW	[7:0]	SW_IN_SET_75	SW_OUT_SET_75	SW_IN_75		SW_OUT_75			0x00	R/W	
0x197	LUT75_FILTER	[7:0]	HPF_75				LPF_75				0x00	R/W
0x198	LUT76_SW	[7:0]	SW_IN_SET_76	SW_OUT_SET_76	SW_IN_76		SW_OUT_76			0x00	R/W	
0x199	LUT76_FILTER	[7:0]	HPF_76				LPF_76				0x00	R/W
0x19A	LUT77_SW	[7:0]	SW_IN_SET_77	SW_OUT_SET_77	SW_IN_77		SW_OUT_77			0x00	R/W	
0x19B	LUT77_FILTER	[7:0]	HPF_77				LPF_77				0x00	R/W
0x19C	LUT78_SW	[7:0]	SW_IN_SET_78	SW_OUT_SET_78	SW_IN_78		SW_OUT_78			0x00	R/W	
0x19D	LUT78_FILTER	[7:0]	HPF_78				LPF_78				0x00	R/W

Reg	Name	Bits	Bit 7	Bit 6	Bit 5	Bit 4	Bit 3	Bit 2	Bit 1	Bit 0	Reset	R/W	
0x19E	LUT79_SW	[7:0]	SW_IN_SET_79	SW_OUT_SET_79	SW_IN_79			SW_OUT_79			0x00	R/W	
0x19F	LUT79_FILTER	[7:0]	HPF_79						LPF_79			0x00	R/W
0x1A0	LUT80_SW	[7:0]	SW_IN_SET_80	SW_OUT_SET_80	SW_IN_80			SW_OUT_80			0x00	R/W	
0x1A1	LUT80_FILTER	[7:0]	HPF_80						LPF_80			0x00	R/W
0x1A2	LUT81_SW	[7:0]	SW_IN_SET_81	SW_OUT_SET_81	SW_IN_81			SW_OUT_81			0x00	R/W	
0x1A3	LUT81_FILTER	[7:0]	HPF_81						LPF_81			0x00	R/W
0x1A4	LUT82_SW	[7:0]	SW_IN_SET_82	SW_OUT_SET_82	SW_IN_82			SW_OUT_82			0x00	R/W	
0x1A5	LUT82_FILTER	[7:0]	HPF_82						LPF_82			0x00	R/W
0x1A6	LUT83_SW	[7:0]	SW_IN_SET_83	SW_OUT_SET_83	SW_IN_83			SW_OUT_83			0x00	R/W	
0x1A7	LUT83_FILTER	[7:0]	HPF_83						LPF_83			0x00	R/W
0x1A8	LUT84_SW	[7:0]	SW_IN_SET_84	SW_OUT_SET_84	SW_IN_84			SW_OUT_84			0x00	R/W	
0x1A9	LUT84_FILTER	[7:0]	HPF_84						LPF_84			0x00	R/W
0x1AA	LUT85_SW	[7:0]	SW_IN_SET_85	SW_OUT_SET_85	SW_IN_85			SW_OUT_85			0x00	R/W	
0x1AB	LUT85_FILTER	[7:0]	HPF_85						LPF_85			0x00	R/W
0x1AC	LUT86_SW	[7:0]	SW_IN_SET_86	SW_OUT_SET_86	SW_IN_86			SW_OUT_86			0x00	R/W	
0x1AD	LUT86_FILTER	[7:0]	HPF_86						LPF_86			0x00	R/W
0x1AE	LUT87_SW	[7:0]	SW_IN_SET_87	SW_OUT_SET_87	SW_IN_87			SW_OUT_87			0x00	R/W	
0x1AF	LUT87_FILTER	[7:0]	HPF_87						LPF_87			0x00	R/W
0x1B0	LUT88_SW	[7:0]	SW_IN_SET_88	SW_OUT_SET_88	SW_IN_88			SW_OUT_88			0x00	R/W	
0x1B1	LUT88_FILTER	[7:0]	HPF_88						LPF_88			0x00	R/W
0x1B2	LUT89_SW	[7:0]	SW_IN_SET_89	SW_OUT_SET_89	SW_IN_89			SW_OUT_89			0x00	R/W	
0x1B3	LUT89_FILTER	[7:0]	HPF_89						LPF_89			0x00	R/W
0x1B4	LUT90_SW	[7:0]	SW_IN_SET_90	SW_OUT_SET_90	SW_IN_90			SW_OUT_90			0x00	R/W	
0x1B5	LUT90_FILTER	[7:0]	HPF_90						LPF_90			0x00	R/W
0x1B6	LUT91_SW	[7:0]	SW_IN_SET_91	SW_OUT_SET_91	SW_IN_91			SW_OUT_91			0x00	R/W	
0x1B7	LUT91_FILTER	[7:0]	HPF_91						LPF_91			0x00	R/W
0x1B8	LUT92_SW	[7:0]	SW_IN_SET_92	SW_OUT_SET_92	SW_IN_92			SW_OUT_92			0x00	R/W	
0x1B9	LUT92_FILTER	[7:0]	HPF_92						LPF_92			0x00	R/W
0x1BA	LUT93_SW	[7:0]	SW_IN_SET_93	SW_OUT_SET_93	SW_IN_93			SW_OUT_93			0x00	R/W	
0x1BB	LUT93_FILTER	[7:0]	HPF_93						LPF_93			0x00	R/W
0x1BC	LUT94_SW	[7:0]	SW_IN_SET_94	SW_OUT_SET_94	SW_IN_94			SW_OUT_94			0x00	R/W	
0x1BD	LUT94_FILTER	[7:0]	HPF_94						LPF_94			0x00	R/W
0x1BE	LUT95_SW	[7:0]	SW_IN_SET_95	SW_OUT_SET_95	SW_IN_95			SW_OUT_95			0x00	R/W	
0x1BF	LUT95_FILTER	[7:0]	HPF_95						LPF_95			0x00	R/W
0x1C0	LUT96_SW	[7:0]	SW_IN_SET_96	SW_OUT_SET_96	SW_IN_96			SW_OUT_96			0x00	R/W	
0x1C1	LUT96_FILTER	[7:0]	HPF_96						LPF_96			0x00	R/W
0x1C2	LUT97_SW	[7:0]	SW_IN_SET_97	SW_OUT_SET_97	SW_IN_97			SW_OUT_97			0x00	R/W	
0x1C3	LUT97_FILTER	[7:0]	HPF_97						LPF_97			0x00	R/W
0x1C4	LUT98_SW	[7:0]	SW_IN_SET_98	SW_OUT_SET_98	SW_IN_98			SW_OUT_98			0x00	R/W	
0x1C5	LUT98_FILTER	[7:0]	HPF_98						LPF_98			0x00	R/W
0x1C6	LUT99_SW	[7:0]	SW_IN_SET_99	SW_OUT_SET_99	SW_IN_99			SW_OUT_99			0x00	R/W	
0x1C7	LUT99_FILTER	[7:0]	HPF_99						LPF_99			0x00	R/W
0x1C8	LUT100_SW	[7:0]	SW_IN_SET_100	SW_OUT_SET_100	SW_IN_100			SW_OUT_100			0x00	R/W	
0x1C9	LUT100_FILTER	[7:0]	HPF_100						LPF_100			0x00	R/W
0x1CA	LUT101_SW	[7:0]	SW_IN_SET_101	SW_OUT_SET_101	SW_IN_101			SW_OUT_101			0x00	R/W	
0x1CB	LUT101_FILTER	[7:0]	HPF_101						LPF_101			0x00	R/W

Reg	Name	Bits	Bit 7	Bit 6	Bit 5	Bit 4	Bit 3	Bit 2	Bit 1	Bit 0	Reset	R/W
0x1CC	LUT102_SW	[7:0]	SW_IN_SET_102	SW_OUT_SET_102	SW_IN_102		SW_OUT_102			0x00	R/W	
0x1CD	LUT102_FILTER	[7:0]	HPF_102				LPF_102				0x00	R/W
0x1CE	LUT103_SW	[7:0]	SW_IN_SET_103	SW_OUT_SET_103	SW_IN_103		SW_OUT_103			0x00	R/W	
0x1CF	LUT103_FILTER	[7:0]	HPF_103				LPF_103				0x00	R/W
0x1D0	LUT104_SW	[7:0]	SW_IN_SET_104	SW_OUT_SET_104	SW_IN_104		SW_OUT_104			0x00	R/W	
0x1D1	LUT104_FILTER	[7:0]	HPF_104				LPF_104				0x00	R/W
0x1D2	LUT105_SW	[7:0]	SW_IN_SET_105	SW_OUT_SET_105	SW_IN_105		SW_OUT_105			0x00	R/W	
0x1D3	LUT105_FILTER	[7:0]	HPF_105				LPF_105				0x00	R/W
0x1D4	LUT106_SW	[7:0]	SW_IN_SET_106	SW_OUT_SET_106	SW_IN_106		SW_OUT_106			0x00	R/W	
0x1D5	LUT106_FILTER	[7:0]	HPF_106				LPF_106				0x00	R/W
0x1D6	LUT107_SW	[7:0]	SW_IN_SET_107	SW_OUT_SET_107	SW_IN_107		SW_OUT_107			0x00	R/W	
0x1D7	LUT107_FILTER	[7:0]	HPF_107				LPF_107				0x00	R/W
0x1D8	LUT108_SW	[7:0]	SW_IN_SET_108	SW_OUT_SET_108	SW_IN_108		SW_OUT_108			0x00	R/W	
0x1D9	LUT108_FILTER	[7:0]	HPF_108				LPF_108				0x00	R/W
0x1DA	LUT109_SW	[7:0]	SW_IN_SET_109	SW_OUT_SET_109	SW_IN_109		SW_OUT_109			0x00	R/W	
0x1DB	LUT109_FILTER	[7:0]	HPF_109				LPF_109				0x00	R/W
0x1DC	LUT110_SW	[7:0]	SW_IN_SET_110	SW_OUT_SET_110	SW_IN_110		SW_OUT_110			0x00	R/W	
0x1DD	LUT110_FILTER	[7:0]	HPF_110				LPF_110				0x00	R/W
0x1DE	LUT111_SW	[7:0]	SW_IN_SET_111	SW_OUT_SET_111	SW_IN_111		SW_OUT_111			0x00	R/W	
0x1DF	LUT111_FILTER	[7:0]	HPF_111				LPF_111				0x00	R/W
0x1E0	LUT112_SW	[7:0]	SW_IN_SET_112	SW_OUT_SET_112	SW_IN_112		SW_OUT_112			0x00	R/W	
0x1E1	LUT112_FILTER	[7:0]	HPF_112				LPF_112				0x00	R/W
0x1E2	LUT113_SW	[7:0]	SW_IN_SET_113	SW_OUT_SET_113	SW_IN_113		SW_OUT_113			0x00	R/W	
0x1E3	LUT113_FILTER	[7:0]	HPF_113				LPF_113				0x00	R/W
0x1E4	LUT114_SW	[7:0]	SW_IN_SET_114	SW_OUT_SET_114	SW_IN_114		SW_OUT_114			0x00	R/W	
0x1E5	LUT114_FILTER	[7:0]	HPF_114				LPF_114				0x00	R/W
0x1E6	LUT115_SW	[7:0]	SW_IN_SET_115	SW_OUT_SET_115	SW_IN_115		SW_OUT_115			0x00	R/W	
0x1E7	LUT115_FILTER	[7:0]	HPF_115				LPF_115				0x00	R/W
0x1E8	LUT116_SW	[7:0]	SW_IN_SET_116	SW_OUT_SET_116	SW_IN_116		SW_OUT_116			0x00	R/W	
0x1E9	LUT116_FILTER	[7:0]	HPF_116				LPF_116				0x00	R/W
0x1EA	LUT117_SW	[7:0]	SW_IN_SET_117	SW_OUT_SET_117	SW_IN_117		SW_OUT_117			0x00	R/W	
0x1EB	LUT117_FILTER	[7:0]	HPF_117				LPF_117				0x00	R/W
0x1EC	LUT118_SW	[7:0]	SW_IN_SET_118	SW_OUT_SET_118	SW_IN_118		SW_OUT_118			0x00	R/W	
0x1ED	LUT118_FILTER	[7:0]	HPF_118				LPF_118				0x00	R/W
0x1EE	LUT119_SW	[7:0]	SW_IN_SET_119	SW_OUT_SET_119	SW_IN_119		SW_OUT_119			0x00	R/W	
0x1EF	LUT119_FILTER	[7:0]	HPF_119				LPF_119				0x00	R/W
0x1F0	LUT120_SW	[7:0]	SW_IN_SET_120	SW_OUT_SET_120	SW_IN_120		SW_OUT_120			0x00	R/W	
0x1F1	LUT120_FILTER	[7:0]	HPF_120				LPF_120				0x00	R/W
0x1F2	LUT121_SW	[7:0]	SW_IN_SET_121	SW_OUT_SET_121	SW_IN_121		SW_OUT_121			0x00	R/W	
0x1F3	LUT121_FILTER	[7:0]	HPF_121				LPF_121				0x00	R/W
0x1F4	LUT122_SW	[7:0]	SW_IN_SET_122	SW_OUT_SET_122	SW_IN_122		SW_OUT_122			0x00	R/W	
0x1F5	LUT122_FILTER	[7:0]	HPF_122				LPF_122				0x00	R/W
0x1F6	LUT123_SW	[7:0]	SW_IN_SET_123	SW_OUT_SET_123	SW_IN_123		SW_OUT_123			0x00	R/W	
0x1F7	LUT123_FILTER	[7:0]	HPF_123				LPF_123				0x00	R/W
0x1F8	LUT124_SW	[7:0]	SW_IN_SET_124	SW_OUT_SET_124	SW_IN_124		SW_OUT_124			0x00	R/W	
0x1F9	LUT124_FILTER	[7:0]	HPF_124				LPF_124				0x00	R/W

Reg	Name	Bits	Bit 7	Bit 6	Bit 5	Bit 4	Bit 3	Bit 2	Bit 1	Bit 0	Reset	R/W
0x1FA	LUT125_SW	[7:0]	SW_IN_SET_125	SW_OUT_SET_125	SW_IN_125		SW_OUT_125			0x00	R/W	
0x1FB	LUT125_FILTER	[7:0]	HPF_125				LPF_125				0x00	R/W
0x1FC	LUT126_SW	[7:0]	SW_IN_SET_126	SW_OUT_SET_126	SW_IN_126		SW_OUT_126			0x00	R/W	
0x1FD	LUT126_FILTER	[7:0]	HPF_126				LPF_126				0x00	R/W
0x1FE	LUT127_SW	[7:0]	SW_IN_SET_127	SW_OUT_SET_127	SW_IN_127		SW_OUT_127			0x00	R/W	
0x1FF	LUT127_FILTER	[7:0]	HPF_127				LPF_127				0x00	R/W

REGISTER DETAILS

Note that the LUT1_SW to LUT127_FILTER bit fields functionality (Register 0x102 to Register 0x1FF) is identical to LUT0_SW and LUT0_FILTER bit fields functionality (Register 0x100 and Register 0x101). See Table 6 for the register address information.

Address: 0x000, Reset: 0x00, Name: ADI_SPI_CONFIG_A

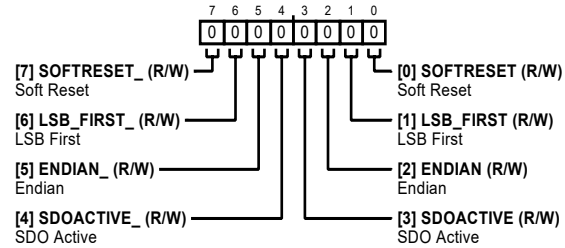

Table 7. Bit Descriptions for ADI_SPI_CONFIG_A

Bits	Bit Name	Description	Reset	Access
7	SOFTRESET_	Soft Reset. 0: reset asserted. 1: reset not asserted.	0x0	R/W
6	LSB_FIRST_	LSB First. 0: LSB first. 1: MSB first.	0x0	R/W
5	ENDIAN_	Endian. 0: Little Endian. 1: Big Endian.	0x0	R/W
4	SDOACTIVE_	SDO Active. 0: SDO inactive. 1: SDO active.	0x0	R/W
3	SDOACTIVE	SDO Active. 0: SDO inactive. 1: SDO active.	0x0	R/W
2	ENDIAN	Endian. 0: Little Endian. 1: Big Endian.	0x0	R/W
1	LSB_FIRST	LSB First. 0: LSB first. 1: MSB first.	0x0	R/W
0	SOFTRESET	Soft Reset. 0: Reset asserted. 1: Reset not asserted.	0x0	R/W

Address: 0x001, Reset: 0x00, Name: ADI_SPI_CONFIG_B

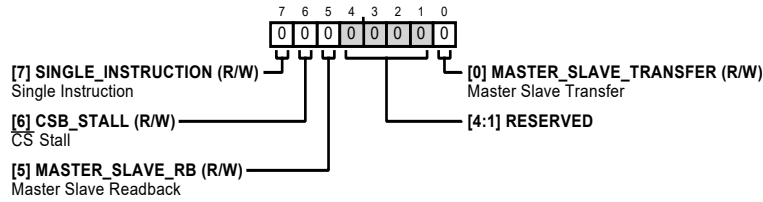

Table 8. Bit Descriptions for ADI_SPI_CONFIG_B

Bits	Bit Name	Description	Reset	Access
7	SINGLE_INSTRUCTION	Single Instruction. 0: enable streaming. 1: disable streaming (regardless of \overline{CS}).	0x0	R/W
6	CSB_STALL	\overline{CS} Stall.	0x0	R/W
5	MASTER_SLAVE_RB	Master Slave Readback.	0x0	R/W
[4:1]	RESERVED	Reserved.	0x0	R
0	MASTER_SLAVE_TRANSFER	Master Slave Transfer.	0x0	R/W

Address: 0x003, Reset: 0x01, Name: CHIPTYPE

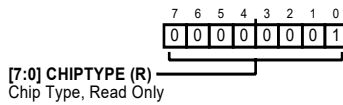

Table 9. Bit Descriptions for CHIPTYPE

Bits	Bit Name	Description	Reset	Access
[7:0]	CHIPTYPE	Chip Type, Read Only.	0x1	R

Address: 0x004, Reset: 0x18, Name: PRODUCT_ID_L

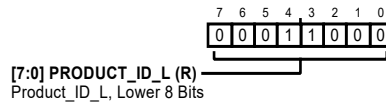

Table 10. Bit Descriptions for PRODUCT_ID_L

Bits	Bit Name	Description	Reset	Access
[7:0]	PRODUCT_ID_L	Product_ID_L, Lower 8 Bits.	0x18	R

Address: 0x005, Reset: 0x88, Name: PRODUCT_ID_H

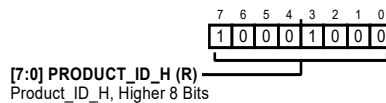

Table 11. Bit Descriptions for PRODUCT_ID_H

Bits	Bit Name	Description	Reset	Access
[7:0]	PRODUCT_ID_H	Product_ID_H, Higher 8 Bits.	0x88	R

Address: 0x010, Reset: 0x00, Name: FAST_LATCH_POINTER

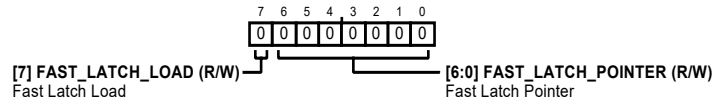

Table 12. Bit Descriptions for FAST_LATCH_POINTER

Bits	Bit Name	Description	Reset	Access
7	FAST_LATCH_LOAD	Fast Latch Load. Loads the pointer location into the internal state machine for fast latch mode. The FAST_LATCH_LOAD bit self resets to zero.	0x0	R/W
[6:0]	FAST_LATCH_POINTER	Fast Latch Pointer. Determines the pointer location within the fast latch lookup table.	0x0	R/W

Address: 0x011, Reset: 0x7F, Name: FAST_LATCH_STOP

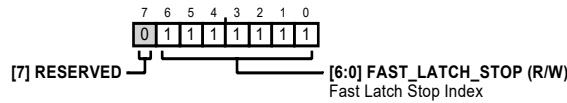

Table 13. Bit Descriptions for FAST_LATCH_STOP

Bits	Bit Name	Description	Reset	Access
7	RESERVED	Reserved.	0x0	R
[6:0]	FAST_LATCH_STOP	Fast Latch Stop Index. Sets the stop index within the fast latch lookup table.	0x7F	R/W

Address: 0x012, Reset: 0x00, Name: FAST_LATCH_START

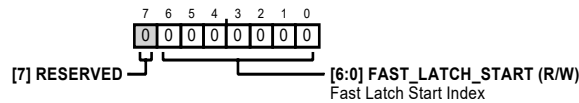

Table 14. Bit Descriptions for FAST_LATCH_START

Bits	Bit Name	Description	Reset	Access
7	RESERVED	Reserved.	0x0	R
[6:0]	FAST_LATCH_START	Fast Latch Start Index. Sets the start index within the fast latch lookup table. Note that, when exiting and then re-entering fast latch mode (SFL pin), the internal state machine resumes where it left off and not at the start index. If a new start index is programmed, it may be necessary to sequence through a number of states from the point at which the state machine left off. This action is necessary for a positive incremental direction. For a negative decremental direction, this action is necessary for the stop index.	0x0	R/W

Address: 0x013, Reset: 0x00, Name: FAST_LATCH_DIRECTION

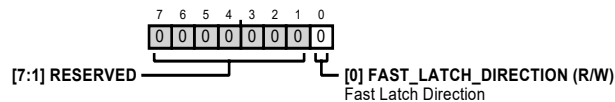

Table 15. Bit Descriptions for FAST_LATCH_DIRECTION

Bits	Bit Name	Description	Reset	Access
[7:1]	RESERVED	Reserved.	0x0	R
0	FAST_LATCH_DIRECTION	Fast Latch Direction. Determines which direction to sequence within the fast latch lookup table. 0: increment. 1: decrement.	0x0	R/W

Address: 0x014, Reset: 0x00, Name: FAST_LATCH_STATE

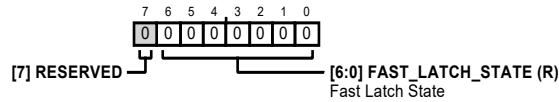

Table 16. Bit Descriptions for FAST_LATCH_STATE

Bits	Bit Name	Description	Reset	Access
7	RESERVED	Reserved.	0x0	R
[6:0]	FAST_LATCH_STATE	Fast Latch State. Reads back the internal state machine pointer.	0x0	R

Address: 0x020, Reset: 0x00, Name: WR0_SW

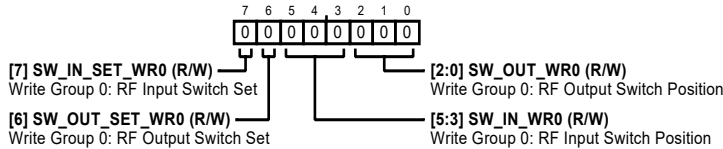

Table 17. Bit Descriptions for WR0_SW

Bits	Bit Name	Description	Reset	Access
7	SW_IN_SET_WRO	Write Group 0: RF Input Switch Set. Sets the switch position to be as defined in Bits[5:3].	0x0	R/W
6	SW_OUT_SET_WRO	Write Group 0: RF Output Switch Set. Sets the switch position to be as defined in Bits[2:0].	0x0	R/W
[5:3]	SW_IN_WRO	Write Group 0: RF Input Switch Position. Defines the RF input switch position, as well as which filter band is adjusted by the corresponding HPF state bits. 000: bypass. 001: Band 1. 010: Band 2. 011: Band 3. 100: Band 4.	0x0	R/W
[2:0]	SW_OUT_WRO	Write Group 0: RF Output Switch Position. Defines the RF output switch position, as well as which filter band is adjusted by the corresponding LPF state bits. 000: bypass. 001: Band 1. 010: Band 2. 011: Band 3. 100: Band 4.	0x0	R/W

Address: 0x021, Reset: 0x00, Name: WR0_FILTER

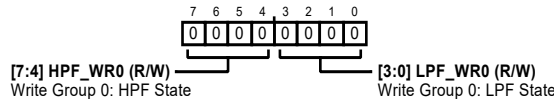

Table 18. Bit Descriptions for WR0_FILTER

Bits	Bit Name	Description	Reset	Access
[7:4]	HPF_WRO	Write Group 0: HPF State. The selected band is determined by the WR0_SW register, Bits[5:3].	0x0	R/W
[3:0]	LPF_WRO	Write Group 0: LPF State. The selected band is determined by the WR0_SW register, Bits[2:0].	0x0	R/W

Address: 0x022, Reset: 0x00, Name: WR1_SW

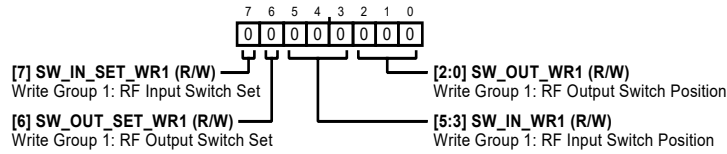

Table 19. Bit Descriptions for WR1_SW

Bits	Bit Name	Description	Reset	Access
7	SW_IN_SET_WR1	Write Group 1: RF Input Switch Set. Sets the switch position to be as defined in Bits[5:3].	0x0	R/W
6	SW_OUT_SET_WR1	Write Group 1: RF Output Switch Set. Sets the switch position to be as defined in Bits[2:0].	0x0	R/W
[5:3]	SW_IN_WR1	Write Group 1: RF Input Switch Position. Defines the RF input switch position, as well as which filter band is adjusted by the corresponding HPF state bits. 000: Bypass. 001: Band 1. 010: Band 2. 011: Band 3. 100: Band 4.	0x0	R/W
[2:0]	SW_OUT_WR1	Write Group 1: RF Output Switch Position. Defines the RF output switch position, as well as which filter band is adjusted by the corresponding LPF state bits. 000: bypass. 001: Band 1. 010: Band 2. 011: Band 3. 100: Band 4.	0x0	R/W

Address: 0x023, Reset: 0x00, Name: WR1_FILTER

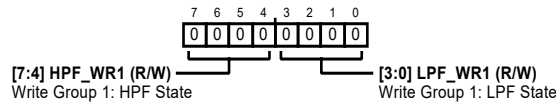

Table 20. Bit Descriptions for WR1_FILTER

Bits	Bit Name	Description	Reset	Access
[7:4]	HPF_WR1	Write Group 1: HPF State. The selected band is determined by the WR1_SW register, Bits[5:3].	0x0	R/W
[3:0]	LPF_WR1	Write Group 1: LPF State. The selected band is determined by the WR1_SW register, Bits[2:0].	0x0	R/W

Address: 0x024, Reset: 0x00, Name: WR2_SW

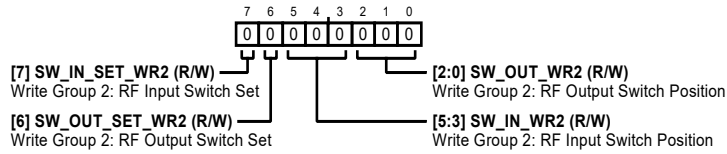

Table 21. Bit Descriptions for WR2_SW

Bits	Bit Name	Description	Reset	Access
7	SW_IN_SET_WR2	Write Group 2: RF Input Switch Set. Sets the switch position to be as defined in Bits[5:3].	0x0	R/W
6	SW_OUT_SET_WR2	Write Group 2: RF Output Switch Set. Sets the switch position to be as defined in Bits[2:0].	0x0	R/W
[5:3]	SW_IN_WR2	Write Group 2: RF Input Switch Position. Defines the RF input switch position, as well as which filter band is adjusted by the corresponding HPF state bits. 000: bypass. 001: Band 1. 010: Band 2. 011: Band 3. 100: Band 4.	0x0	R/W
[2:0]	SW_OUT_WR2	Write Group 2: RF Output Switch Position. Defines the RF output switch position, as well as which filter band is adjusted by the corresponding LPF state bits. 000: bypass. 001: Band 1. 010: Band 2. 011: Band 3. 100: Band 4.	0x0	R/W

Address: 0x025, Reset: 0x00, Name: WR2_FILTER

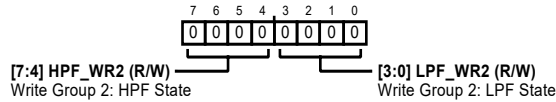

Table 22. Bit Descriptions for WR2_FILTER

Bits	Bit Name	Description	Reset	Access
[7:4]	HPF_WR2	Write Group 2: HPF State. The selected band is determined by the WR2_SW register, Bits[5:3].	0x0	R/W
[3:0]	LPF_WR2	Write Group 2: LPF State. The selected band is determined by the WR2_SW register, Bits[2:0].	0x0	R/W

Address: 0x026, Reset: 0x00, Name: WR3_SW

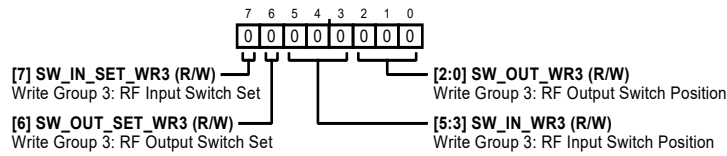

Table 23. Bit Descriptions for WR3_SW

Bits	Bit Name	Description	Reset	Access
7	SW_IN_SET_WR3	Write Group 3: RF Input Switch Set. Sets the switch position to be as defined in Bits[5:3].	0x0	R/W
6	SW_OUT_SET_WR3	Write Group 3: RF Output Switch Set. Sets the switch position to be as defined in Bits[2:0].	0x0	R/W
[5:3]	SW_IN_WR3	Write Group 3: RF Input Switch Position. Defines the RF input switch position, as well as which filter band is adjusted by the corresponding HPF state bits. 000: bypass. 001: Band 1. 010: Band 2. 011: Band 3. 100: Band 4.	0x0	R/W
[2:0]	SW_OUT_WR3	Write Group 3: RF Output Switch Position. Defines the RF output switch position, as well as which filter band is adjusted by the corresponding LPF state bits. 000: bypass. 001: Band 1. 010: Band 2. 011: Band 3. 100: Band 4.	0x0	R/W

Address: 0x027, Reset: 0x00, Name: WR3_FILTER

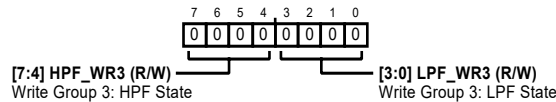

Table 24. Bit Descriptions for WR3_FILTER

Bits	Bit Name	Description	Reset	Access
[7:4]	HPF_WR3	Write Group 3: HPF State. The selected band is determined by the WR3_SW register, Bits[5:3].	0x0	R/W
[3:0]	LPF_WR3	Write Group 3: LPF State. The selected band is determined by the WR3_SW register, Bits[2:0].	0x0	R/W

Address: 0x028, Reset: 0x00, Name: WR4_SW

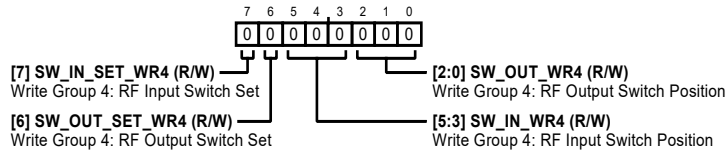

Table 25. Bit Descriptions for WR4_SW

Bits	Bit Name	Description	Reset	Access
7	SW_IN_SET_WR4	Write Group 4: RF Input Switch Set. Sets the switch position to be as defined in Bits[5:3].	0x0	R/W
6	SW_OUT_SET_WR4	Write Group 4: RF Output Switch Set. Sets the switch position to be as defined in Bits[2:0].	0x0	R/W
[5:3]	SW_IN_WR4	Write Group 4: RF Input Switch Position. Defines the RF input switch position, as well as which filter band is adjusted by the corresponding HPF state bits. 000: bypass. 001: Band 1. 010: Band 2. 011: Band 3. 100: Band 4.	0x0	R/W
[2:0]	SW_OUT_WR4	Write Group 4: RF Output Switch Position. Defines the RF output switch position, as well as which filter band is adjusted by the corresponding LPF state bits. 000: bypass. 001: Band 1. 010: Band 2. 011: Band 3. 100: Band 4.	0x0	R/W

Address: 0x029, Reset: 0x00, Name: WR4_FILTER

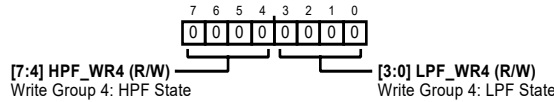

Table 26. Bit Descriptions for WR4_FILTER

Bits	Bit Name	Description	Reset	Access
[7:4]	HPF_WR4	Write Group 4: HPF State. The selected band is determined by the WR4_SW register, Bits[5:3].	0x0	R/W
[3:0]	LPF_WR4	Write Group 4: LPF State. The selected band is determined by the WR4_SW register, Bits[2:0].	0x0	R/W

Address: 0x100, Reset: 0x00, Name: LUT0_SW

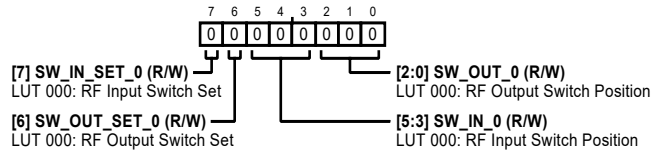

Table 27. Bit Descriptions for LUT0_SW

Bits	Bit Name	Description	Reset	Access
7	SW_IN_SET_0	LUT 000: RF Input Switch Set. Sets the switch position to be as defined in Bits[5:3].	0x0	R/W
6	SW_OUT_SET_0	LUT 000: RF Output Switch Set. Sets the switch position to be as defined in Bits[2:0].	0x0	R/W
[5:3]	SW_IN_0	LUT 000: RF Input Switch Position. Defines the RF input switch position, as well as which filter band is adjusted by the corresponding HPF state bits. 000: bypass. 001: Band 1. 010: Band 2. 011: Band 3. 100: Band 4.	0x0	R/W
[2:0]	SW_OUT_0	LUT 000: RF Output Switch Position. Defines the RF output switch position, as well as which filter band is adjusted by the corresponding LPF state bits. 000: bypass. 001: Band 1. 010: Band 2. 011: Band 3. 100: Band 4.	0x0	R/W

Address: 0x101, Reset: 0x00, Name: LUT0_FILTER

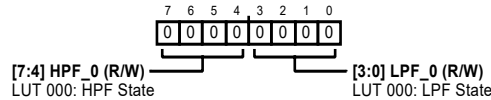

Table 28. Bit Descriptions for LUT0_FILTER

Bits	Bit Name	Description	Reset	Access
[7:4]	HPF_0	LUT 000: HPF State. The selected band is determined by the LUT0_SW register, Bits[5:3].	0x0	R/W
[3:0]	LPF_0	LUT 000: LPF State. The selected band is determined by the LUT0_SW register, Bits[2:0].	0x0	R/W

OUTLINE DIMENSIONS

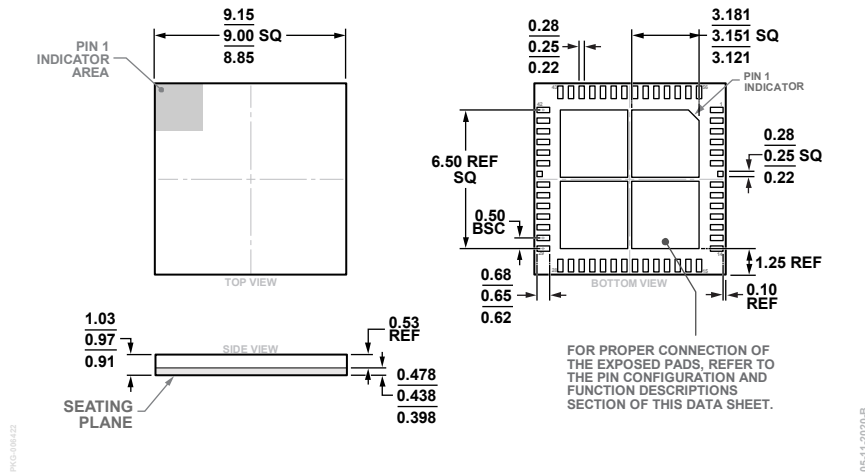

Figure 38. 56-Terminal Land Grid Array [LGA]
 9 mm x 9 mm Body and 0.97 mm Package Height
 (CC-56-3)
 Dimensions shown in millimeters

ORDERING GUIDE

Model ¹	Temperature Range	Package Description	Package Option
ADMV8818SCCZ-EP	-55°C to +105°C	56-Terminal Land Grid Array [LGA]	CC-56-3
ADMV8818SCCZ-EP-R2	-55°C to +105°C	56-Terminal Land Grid Array [LGA], 2" Tape and Reel	CC-56-3
ADMV8818SCCZ-EP-P7	-55°C to +105°C	56-Terminal Land Grid Array [LGA],	CC-56-3
ADMV8818-EVALZ		Evaluation Board	

¹ Z = RoHS Compliant Part.

Looking for pricing, stock, or lifecycle information?

Click below to explore more details on WIN SOURCE:

 [View ADMV8818SCCZ-EP on WIN SOURCE](#)

 [Analog Devices Inc. Information](#)

Optimize Your Supply Chain with WIN SOURCE Solutions

-  Global Sourcing Solution
-  Obsolete Management
-  Cost Control Management
-  Shortage Management
-  Alternative Solution
-  Excess Inventory Management