



**THE DATASHEET OF
DLP11SN670SL2L**



Common Mode Choke Coil Film Type

DLP11S/DLP11R/DLP11T Series (0504 Size)

■ Dimensions

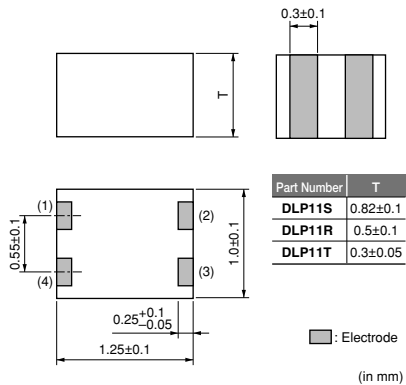

■ Equivalent Circuit

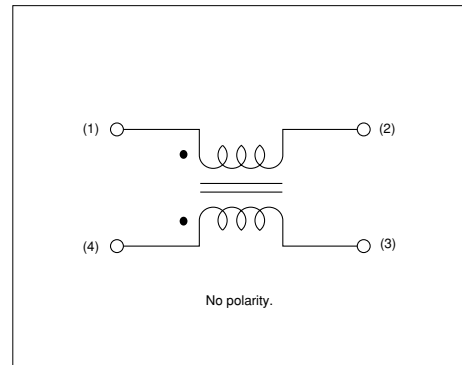

■ Impedance-Frequency Characteristics (Main Items)

DLP11SN Series

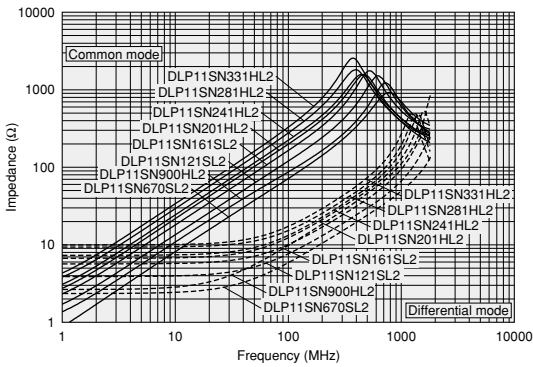

■ Impedance-Frequency Characteristics (Main Items)

DLP11SA Series

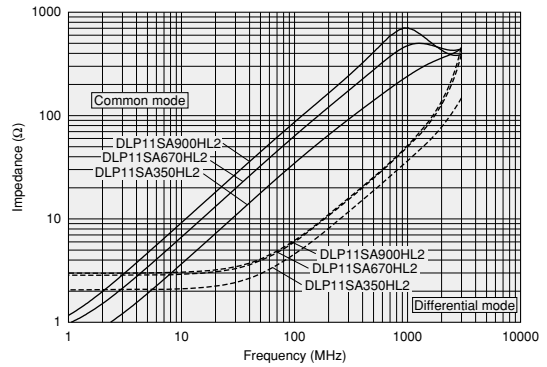

■ Impedance-Frequency Characteristics (Main Items)

DLP11RN Series

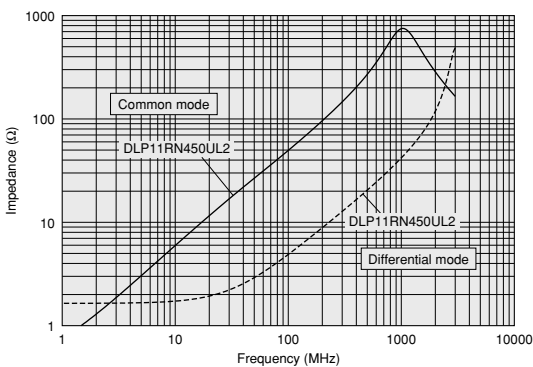

■ Impedance-Frequency Characteristics (Main Items)

DLP11RB Series

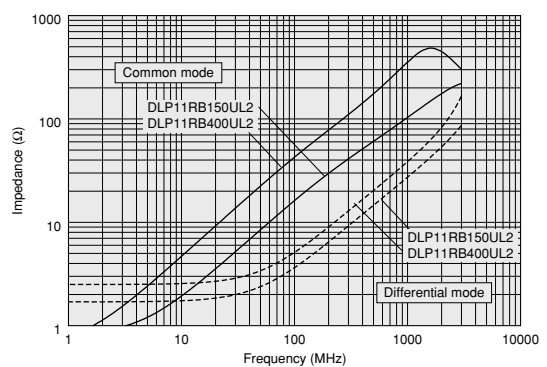

Continued on the following page.

● This data sheet is applied for CHIP COMMON MODE CHOKE COIL used for General Electronics equipment for your design.

⚠ Note:

1. This datasheet is downloaded from the website of Murata Manufacturing co., Ltd. Therefore, it's specifications are subject to change or our products in it may be discontinued without advance notice. Please check with our sales representatives or product engineers before ordering.
2. This datasheet has only typical specifications because there is no space for detailed specifications. Therefore, please approve our product specifications or transact the approval sheet for product specifications before ordering.

Continued from the preceding page.

Impedance-Frequency Characteristics (Main Items)

DLP11TB Series

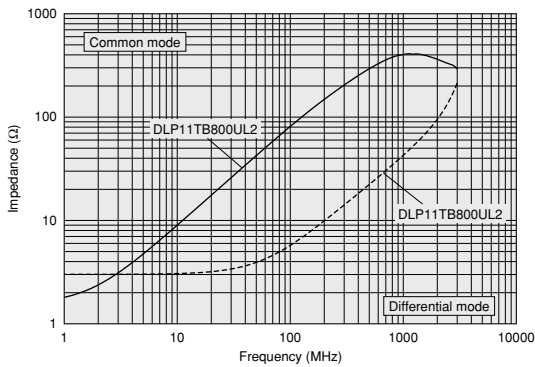

Differential Mode Transmission Characteristics (Typ.)

DLP11SN Series

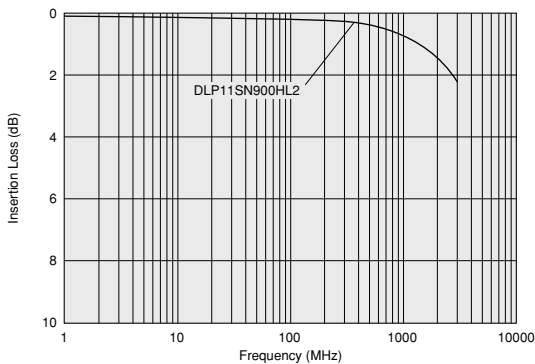

Differential Mode Transmission Characteristics (Typ.)

DLP11SA Series

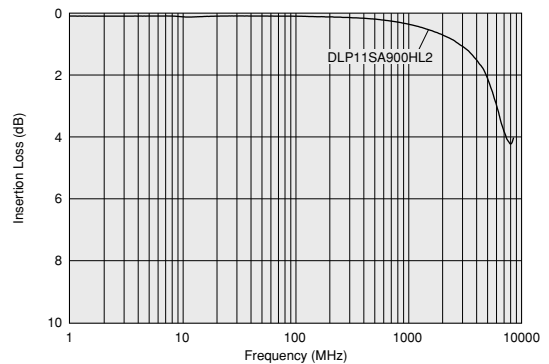

Differential Mode Transmission Characteristics (Typ.)

DLP11RN Series

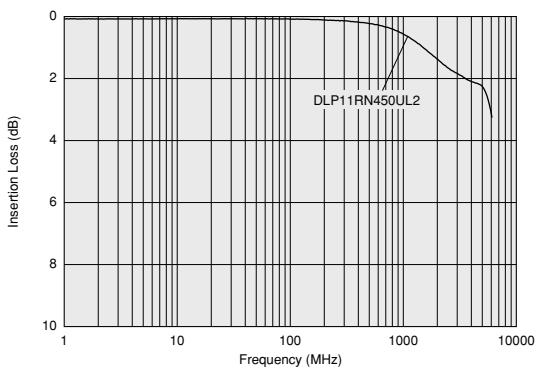

Differential Mode Transmission Characteristics (Typ.)

DLP11RB Series

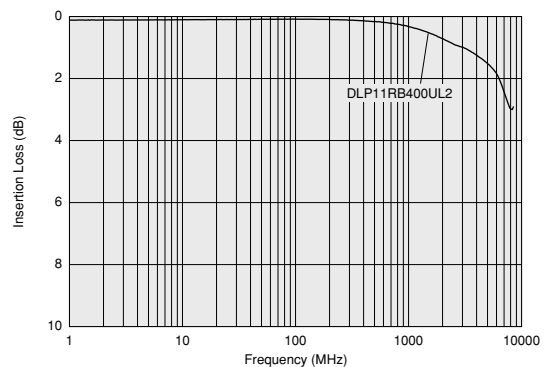

Continued on the following page.

● This data sheet is applied for CHIP COMMON MODE CHOKE COIL used for General Electronics equipment for your design.

Note:

1. This datasheet is downloaded from the website of Murata Manufacturing co., ltd. Therefore, it's specifications are subject to change or our products in it may be discontinued without advance notice. Please check with our sales representatives or product engineers before ordering.
2. This datasheet has only typical specifications because there is no space for detailed specifications. Therefore, please approve our product specifications or transact the approval sheet for product specifications before ordering.

 Continued from the preceding page.

■ Differential Mode Transmission Characteristics (Typ.)

DLP11TB Series

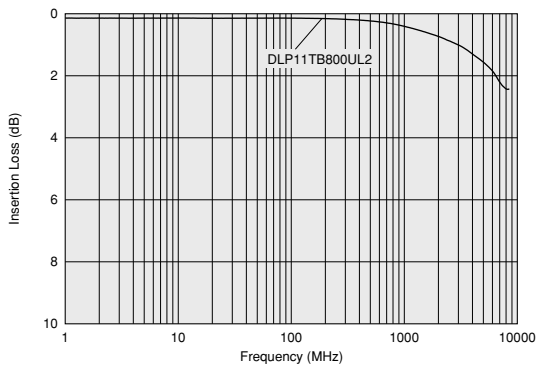

■ Packaging

Code	Packaging	Minimum Quantity
L	180mm Embossed Tape	3000 (DLP11S)
		4000 (DLP11RN/RB)
		5000 (DLP11T)
B	Bulk(Bag)	500

■ Rated Value (□: packaging code)

Part Number	Common Mode Impedance (at 100MHz/20°C)	Rated Current	Rated Voltage	Insulation Resistance (min.)	Withstand Voltage	DC Resistance	Operating Temperature Range
DLP11SN670SL2□	67ohm ±20%	180mA	5Vdc	100M ohm	12.5Vdc	1.3ohm±25%	-40 to +85°C
DLP11SN121SL2□	120ohm ±20%	140mA	5Vdc	100M ohm	12.5Vdc	2.0ohm±25%	-40 to +85°C
DLP11SN161SL2□	160ohm ±20%	120mA	5Vdc	100M ohm	12.5Vdc	2.7ohm±25%	-40 to +85°C
DLP11SN900HL2□	90ohm ±20%	150mA	5Vdc	100M ohm	12.5Vdc	1.5ohm±25%	-40 to +85°C
DLP11SN201HL2□	200ohm ±20%	110mA	5Vdc	100M ohm	12.5Vdc	3.1ohm±25%	-40 to +85°C
DLP11SN241HL2□	240ohm ±20%	100mA	5Vdc	100M ohm	12.5Vdc	3.5ohm±25%	-40 to +85°C
DLP11SN281HL2□	280ohm ±20%	90mA	5Vdc	100M ohm	12.5Vdc	4.2ohm±25%	-40 to +85°C
DLP11SN331HL2□	330ohm ±20%	80mA	5Vdc	100M ohm	12.5Vdc	4.9ohm±25%	-40 to +85°C
DLP11SA350HL2□	35ohm ±20%	170mA	5Vdc	100M ohm	12.5Vdc	0.9ohm±25%	-40 to +85°C
DLP11SA670HL2□	67ohm ±20%	150mA	5Vdc	100M ohm	12.5Vdc	1.2ohm±25%	-40 to +85°C
DLP11SA900HL2□	90ohm ±20%	150mA	5Vdc	100M ohm	12.5Vdc	1.4ohm±25%	-40 to +85°C
DLP11RN450UL2□	45ohm ±25%	100mA	5Vdc	100M ohm	12.5Vdc	0.8ohm±25%	-40 to +85°C
DLP11RB150UL2□	15ohm ±5ohm	100mA	5Vdc	100M ohm	12.5Vdc	0.8ohm±25%	-40 to +85°C
DLP11RB400UL2□	40ohm ±10ohm	100mA	5Vdc	100M ohm	12.5Vdc	1.3ohm±25%	-40 to +85°C
DLP11TB800UL2□	80ohm ±25%	100mA	5Vdc	100M ohm	12.5Vdc	1.5ohm±25%	-40 to +85°C

Number of Circuit: 1

Differential mode to common mode conversion characteristic (Scd21) at 2.5GHz

DLP11RB/TB: -40dB

Impedance Characteristics between signal lines Z0 (TDR at 50ps)

DLP11RB/TB: 90ohm±15ohm

■ ⚠ Caution/Notice

⚠ Caution (Rating)

Do not use products beyond the rated current and rated voltage as this may create excessive heat and deteriorate the insulation resistance.

Notice

Solderability of Tin plating termination chip might be deteriorated when low temperature soldering profile where peak solder temperature is below the Tin melting point is used. Please confirm the solderability of Tin plating termination chip before use.



● This data sheet is applied for CHIP COMMON MODE CHOKE COIL used for General Electronics equipment for your design.

⚠ Note:

- This datasheet is downloaded from the website of Murata Manufacturing co., Ltd. Therefore, it's specifications are subject to change or our products in it may be discontinued without advance notice. Please check with our sales representatives or product engineers before ordering.
- This datasheet has only typical specifications because there is no space for detailed specifications. Therefore, please approve our product specifications or transact the approval sheet for product specifications before ordering.

Looking for pricing, stock, or lifecycle information?

Click below to explore more details on WIN SOURCE:

-  [View DLP11SN670SL2L on WIN SOURCE](#)
-  [Murata Electronics North America Information](#)

Optimize Your Supply Chain with WIN SOURCE Solutions

-  Global Sourcing Solution
-  Obsolete Management
-  Cost Control Management
-  Shortage Management
-  Alternative Solution
-  Excess Inventory Management