



# THE DATASHEET OF ADZS-AD2428MINI



# ADZS-AD2428MINI Manual

Revision 1.2 , January 2022

Part Number  
82-AD2428MINI-01

Analog Devices, Inc.  
One Technology Way  
Norwood, MA 02062-9106



# Copyright Information

© 2020 Analog Devices, Inc., ALL RIGHTS RESERVED. This document may not be reproduced in any form without prior, express written consent from Analog Devices, Inc.

## Disclaimer

Analog Devices, Inc. reserves the right to change this product without prior notice. Information furnished by Analog Devices is believed to be accurate and reliable. However, no responsibility is assumed by Analog Devices for its use; nor for any infringement of patents or other rights of third parties which may result from its use. No license is granted by implication or otherwise under the patent rights of Analog Devices, Inc.

## Trademark and Service Mark Notice

All other brand and product names are trademarks or service marks of their respective owners.

# Regulatory Compliance

The *ADZS-AD2428MINI* evaluation board is designed to be used solely in a laboratory environment. The board is not intended for use as a consumer-end product or as a portion of a consumer-end product. The board is an open system design, which does not include a shielded enclosure and, therefore, may cause interference to other electrical devices in close proximity. This board should not be used in or near any medical equipment or RF devices.

The *ADZS-AD2428MINI* evaluation board contains ESD (electrostatic discharge) sensitive devices. Electrostatic charges readily accumulate on the human body and equipment and can discharge without detection. Permanent damage may occur on devices subjected to high-energy discharges. Proper ESD precautions are recommended to avoid performance degradation or loss of functionality. Store unused boards in the protective shipping package.



# Contents

## Preface

Purpose of This Manual.....	1-1
Manual Contents.....	1-1
Technical Support.....	1-2
Supported Integrated Circuit.....	1-2
Supported Tools.....	1-2
Product Information.....	1-2
Analog Devices Website.....	1-2
EngineerZone.....	1-2

## Using the Board

Product Overview.....	2-1
Package Contents.....	2-1
Default Configuration.....	2-2
Reference Design Information.....	2-2
24AA512T - 512K I <sup>2</sup> C Serial EEPROM.....	2-2
AD2428 - Automotive Audio Bus A <sup>2</sup> B Transceiver.....	2-3
LT8620 - 65V, 2A Synchronous Step-Down Regulator with 2.5 $\mu$ A Quiescent Current.....	2-3

## Hardware Reference

System Architecture.....	3-1
Connectors.....	3-2
A <sup>2</sup> B ( P10 and P9 ).....	3-3
A2B Interface( P1 ).....	3-3
A2B Breakout Header( P2 ).....	3-5
Jumpers.....	3-6
IOVDD( P3 ).....	3-7

I2C Address( P4 ).....	3-7
Local Power Mode() .....	3-8
Bus Power Mode() .....	3-8
LEDs .....	3-8
A2B IO1 & IO7 LED ( DS3 and DS1 ).....	3-9
A <sup>2</sup> B Interrupt ( DS2 ).....	3-9

# 1 Preface

Thank you for purchasing the Analog Devices, Inc. *ADZS-AD2428MINI* evaluation board.

The SigmaStudio<sup>®</sup> graphical development tool is the programming, development, and tuning software for the SigmaDSP, A<sup>2</sup>B and Sharc processors. Familiar audio processing blocks can be wired together as in a schematic, and the compiler generates DSP-ready code and a control surface for setting and tuning parameters. This tool allows engineers with no DSP code writing experience to easily implement a DSP into their design and yet is still powerful enough to satisfy the demands of experienced DSP designers. SigmaStudio links with both Analog Devices evaluation boards and production designs to provide full in-circuit real-time IC control.

SigmaStudio includes an extensive library of algorithms to perform audio processing such as filtering, mixing, and dynamics processing, as well as basic low-level DSP functions and control blocks. Advanced record-side processing algorithms such as Enhanced Stereo Capture and wind noise detection are included in the standard libraries. Plug-in algorithms from Analog Devices and 3rd party partners can be added to SigmaStudio's drag-and-drop library.

Along with its graphical DSP signal flow development, SigmaStudio also includes other features to speed up the design cycle from product concept to release. SigmaStudio includes tools for intuitively setting control registers, calculating tables of filter coefficients, visualizing filter magnitude and phase responses, generating C header files, and sequencing a series of controls to ease your transition from SigmaStudio to system implementation on your microcontroller.

## Purpose of This Manual

This manual provides instructions for installing the product hardware (board). This manual describes operation and configuration of the board components and provides guidelines for running code on the board.

## Manual Contents

The manual consists of:

- *Using the board*  
Provides basic board information.
- *Hardware Reference*

Provides information about the hardware aspects of the board.

- *Bill of Materials*

A companion file in PDF format that lists all of the components used on the board is available on the website at <https://my.analog.com/en/myanalog/a2b/a2b-technology.html>.

- *Schematic*

A companion file in PDF format documenting all of the circuits used on the board is available on the website at <https://my.analog.com/en/myanalog/a2b/a2b-technology.html>.

## Technical Support

### Supported Integrated Circuit

This evaluation system supports the Analog Devices AD2428 IC.

### Supported Tools

### Product Information

#### Analog Devices Website

The Analog Devices website, <http://www.analog.com>, provides information about a broad range of products - analog integrated circuits, amplifiers, converters, transceivers, and digital signal processors.

Also note, [MyAnalog.com](http://MyAnalog.com) is a free feature of the Analog Devices website that allows customization of a web page to display only the latest information about products you are interested in. You can choose to receive weekly e-mail notifications containing updates to the web pages that meet your interests, including documentation errata against all manuals. [MyAnalog.com](http://MyAnalog.com) provides access to books, application notes, data sheets, code examples, and more.

Visit [MyAnalog.com](http://MyAnalog.com) to sign up. If you are a registered user, just log on. Your user name is your e-mail address.

#### EngineerZone

EngineerZone is a technical support forum from Analog Devices, Inc. It allows you direct access to ADI technical support engineers. You can search FAQs and technical information to get quick answers to your embedded processing and DSP design questions.

Use EngineerZone to connect with other DSP developers who face similar design challenges. You can also use this open forum to share knowledge and collaborate with the ADI support team and your peers. Visit <http://ez.analog.com> to sign up.

## 2 Using the Board

This chapter provides information on the major components and peripherals on the board, along with instructions for installing and setting up the emulation software.

### Product Overview

The board features:

- Analog Devices [AD2428 - Automotive Audio Bus A<sup>2</sup>B Transceiver](#)
- Analog Devices [LT8620 - 65V, 2A Synchronous Step-Down Regulator with 2.5µA Quiescent Current](#)
- Microchip [24AA512T - 512K I<sup>2</sup>C Serial EEPROM](#)
- A<sup>2</sup>B
  - Two DuraClik connectors
- LEDs
  - Three GPIO LEDs
- External power supply
  - 12V @0.5 Amps

### Package Contents

Your *ADZS-AD2428MINI* package contains the following items.

- *ADZS-AD2428MINI* board
- DuraClik 1.8M cable
- A2B Software - Online Request Document

Contact the vendor where you purchased your *ADZS-AD2428MINI* evaluation board or contact Analog Devices, Inc. if any item is missing.

## Default Configuration

The *ADZS-AD2428MINI* board is designed to run as a standalone unit.

The *Default Hardware Setup* figure shows the default settings for jumpers and switches and the location of the jumpers, switches, connectors, and LEDs. Confirm that your board is in the default configuration before using the board.

Default Config

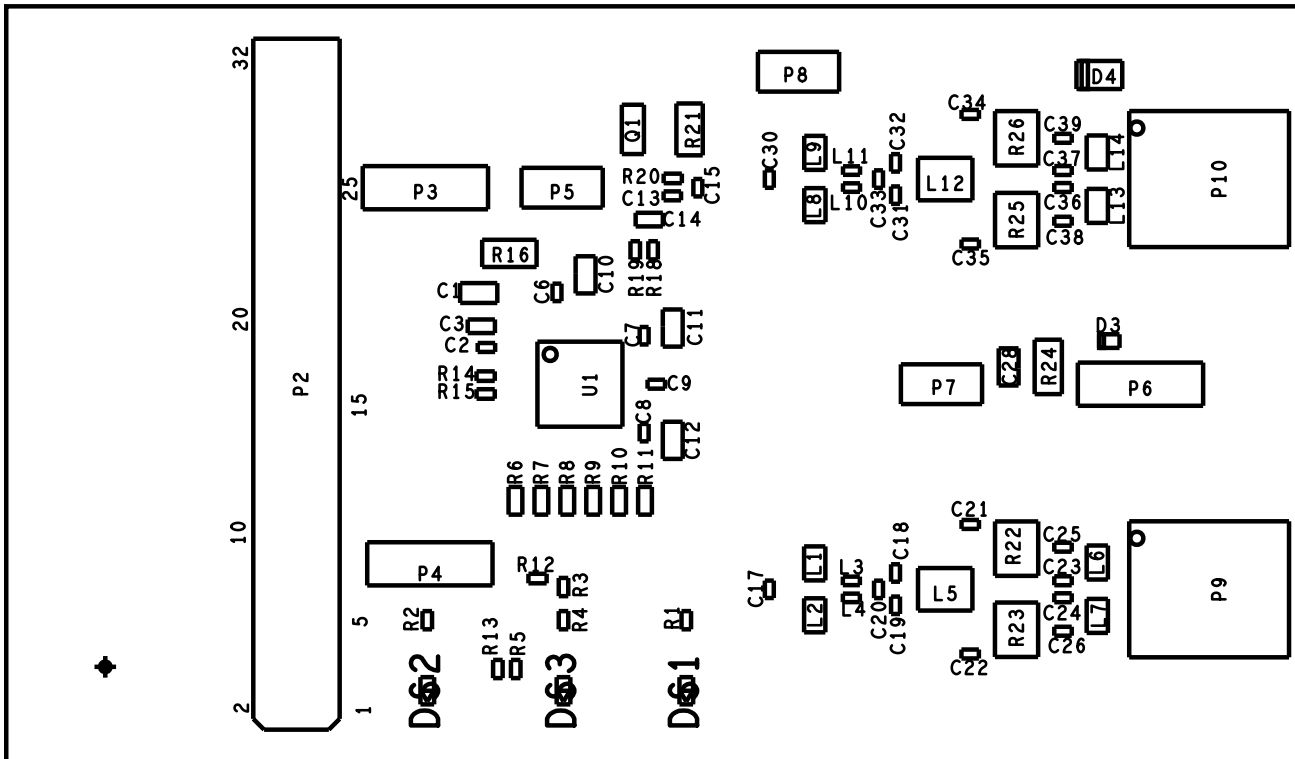

Figure 2-1: Default Hardware Setup

## Reference Design Information

A reference design info package is available for download on the Analog Devices Web site. The package provides information on the schematic design, layout, fabrication, and assembly of the board.

The information can be found at:

<https://my.analog.com/en/myanalog/a2b/a2b-technology.html>

## 24AA512T - 512K I<sup>2</sup>C Serial EEPROM

The Microchip Technology Inc. 24AA512 is a 512Kb (64K x 8) Serial Electrically Erasable PROM (EEPROM), capable of operation across a broad voltage range (1.7V to 5.5V). It has been developed for advanced, low-power

applications such as personal communications and data acquisition. This device also has a page write capability of up to 128 bytes of data. This device is capable of both random and sequential reads up to the 512K boundary. Functional address lines allow up to eight devices on the same bus, for up to 4 Mbit address space. This device is available in the standard 8-pin plastic DIP, SOIJ and DFN packages.

## AD2428 - Automotive Audio Bus A<sup>2</sup>B Transceiver

The Automotive Audio Bus (A<sup>2</sup>B<sup>®</sup>) provides a multichannel, I<sup>2</sup>S/TDM link over distances of up to 15 m between nodes. It embeds bidirectional synchronous pulse-code modulation (PCM) data (for example, digital audio), clock, and synchronization signals onto a single differential wire pair. A<sup>2</sup>B supports a direct point to point connection and allows multiple, daisy-chained nodes at different locations to contribute and/or consume time division multiplexed channel content.

A<sup>2</sup>B is a single-master, multiple-slave system where the transceiver chip at the host controller is the master. The master generates clock, synchronization, and framing for all slave nodes. The master A<sup>2</sup>B chip is programmable over a control bus (I<sup>2</sup>C) for configuration and read back. An extension of this control bus is embedded in the A<sup>2</sup>B data stream, which grants direct access of registers and status information on slave transceivers as well as I<sup>2</sup>C to I<sup>2</sup>C communication over distance.

The transceiver can connect directly to general-purpose digital signal processors (DSPs), field-programmable gate arrays (FPGAs), application specific integrated circuits (ASICs), microphones, analog-to-digital converters (ADCs), digital-to-analog converters (DACs), and codecs through a multichannel I<sup>2</sup>S/TDM interface. It also provides a pulse density modulation (PDM) interface for direct connection of up to four PDM digital microphones.

Finally, the transceiver also supports an A<sup>2</sup>B bus powering feature, where the master node supplies voltage and current to the slave nodes over the same daisy-chained, twisted pair wire cable as used for the communication link.

## LT8620 - 65V, 2A Synchronous Step-Down Regulator with 2.5 $\mu$ A Quiescent Current

The LT8620 is a compact, high efficiency, high speed synchronous monolithic step-down switching regulator that accepts a wide input voltage range up to 65V, and consumes only 2.5 $\mu$ A of quiescent current. Top and bottom power switches are included with all necessary circuitry to minimize the need for external components. Low ripple Burst Mode operation enables high efficiency down to very low output currents while keeping the output ripple below 10mV<sub>p.p.</sub> A SYNC pin allows synchronization to an external clock. Internal compensation with peak current mode topology allows the use of small inductors and results in fast transient response and good loop stability. The EN/UV pin has an accurate 1V threshold and can be used to program V<sub>IN</sub> undervoltage lockout or to shut down the LT8620 reducing the input supply current to 1 $\mu$ A. A capacitor on the TR/SS pin programs the output voltage ramp rate during start-up. The PG flag signals when V<sub>OUT</sub> is within  $\pm$ 9% of the programmed output voltage as well as fault conditions. The LT8620 is available in small 16-Lead MSOP and 3mm  $\times$  5mm QFN packages with exposed pads for low thermal resistance.

## 3 Hardware Reference

This chapter describes the hardware design of the *ADZS-AD2428MINI* .

### System Architecture

The board's configuration is shown in the *Block Diagram* figure.

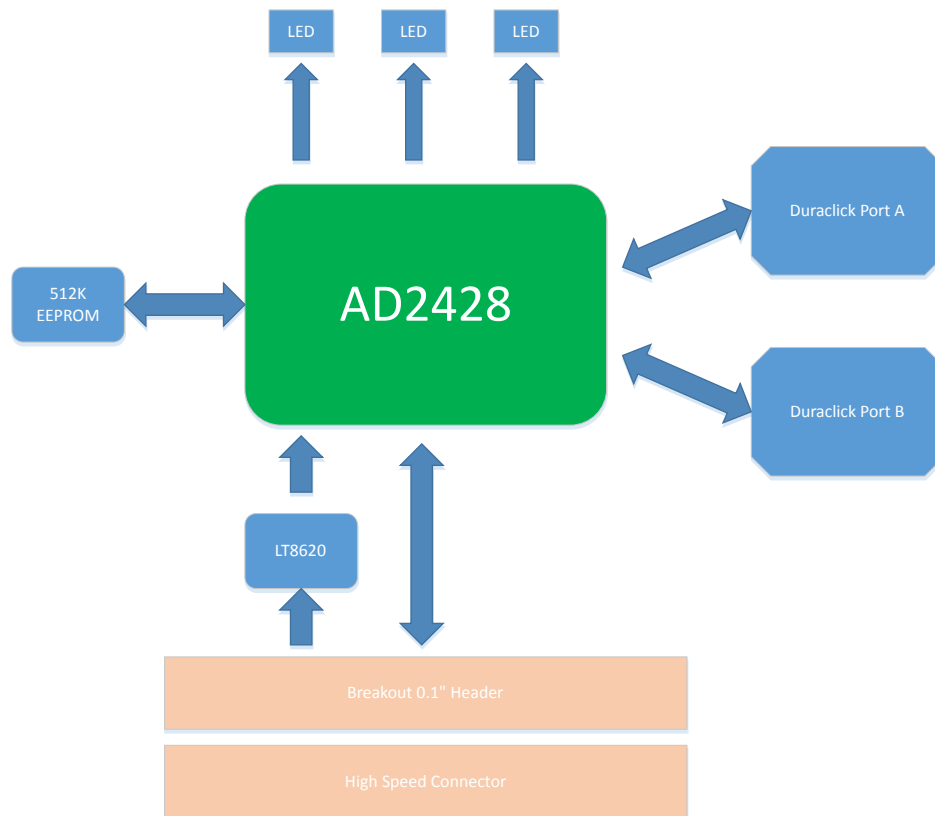

Figure 3-1: Block Diagram

## Connectors

This section describes connector functionality and provides information about mating connectors. The connector locations are shown in the *Connector Locations* figure.

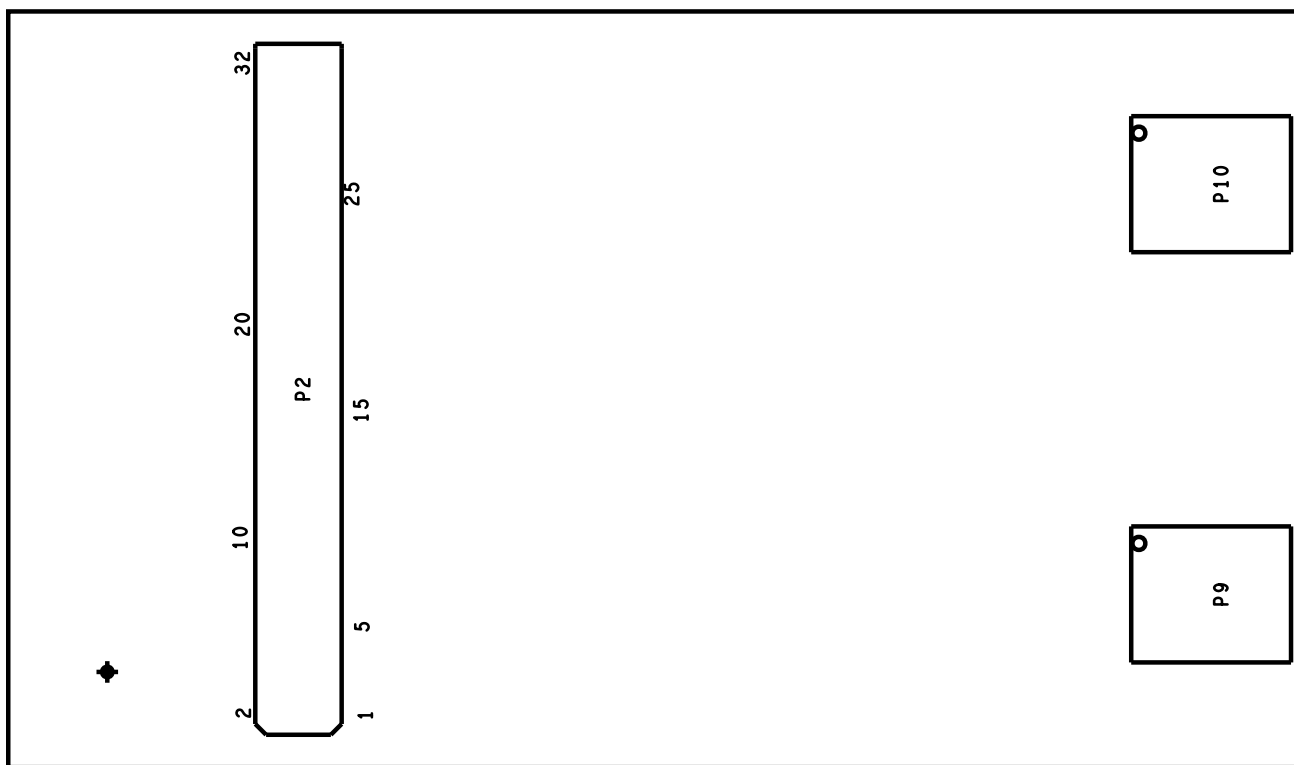

Figure 3-2: Connector Locations

## A<sup>2</sup>B ( P10 and P9 )

P10 is used to connect towards the slave board and P9 is used to connect towards the master board. These connectors allow the AD2428 on the eval board to talk to other A<sup>2</sup>B devices on the bus.

<i>Part Description</i>	<i>Manufacturer</i>	<i>Part Number</i>
2-pin DuraClik	Molex	5023520200
<i>Mating Cable</i>		
DuraClik cable assembly		

## A2B Interface( P1 )

The A<sup>2</sup>B Interface is a high speed connection that allows connecting the ADZS-AD2428MINI to other boards, such as the ADZS-EZKIT-SOM. This connector brings out the signals for I2S, TWI, SPI, GPIO, 1.8v power, 3.3v power, VBUS and also is +12v input for the ADZS-AD2428MINI.

The following table contains the pinout for the A2B Interface high speed connector:

Signal	Pin	Pin	Signal
GND	1	2	GND

## Connectors

Signal	Pin	Pin	Signal
BLCK	3	4	
GND	5	6	GND
SYNC	7	8	
GND	9	10	GND
SIO0	11	12	
GND	13	14	GND
SIO1	15	16	
GND	17	18	GND
SIO2	19	20	
GND	21	22	GND
SIO3	23	24	
GND	25	26	GND
SIO4	27	28	
GND	29	30	GND
SIO5	31	32	
GND	33	34	GND
SIO6	35	36	
GND	37	38	GND
SIO7	39	40	
GND	41	42	GND
IO7	43	44	
GND	45	46	GND
IO2	47	48	
GND	48	50	GND
IO1	51	52	
GND	53	54	GND
-RESET	55	56	
GND	57	58	GND
IRQ	59	60	
GND	61	62	GND
SPI_MISO	63	64	
GND	65	66	GND
SPI_MOSI	67	68	

Signal	Pin	Pin	Signal
GND	69	70	GND
SPI_CLK	71	72	
GND	73	74	GND
-SPI_SS1	75	76	
GND	77	78	GND
-SPI_SS2	79	80	
GND	81	82	GND
I2C_SDA	83	84	
GND	85	86	VOUT1
I2C_SCL	87	88	VOUT2
GND	89	90	GND
GND	91	92	GND
GND	93	94	GND
A2B_VBUS	95	96	VBAT_IN
A2B_VBUS	97	98	VBAT_IN
A2B_VBUS	99	100	VBAT_IN

<i>Part Description</i>	<i>Manufacturer</i>	<i>Part Number</i>
A2B High Speed Interface	SAMTEC	LSS-150-01-L-DV-A-K
<i>Mating Connector</i>		
LSS-150-01-L-DV-A-K		

## A2B Breakout Header( P2 )

The A2B Breakout Header is a 0.1" connection that allows connecting the ADZS-AD2428MINI to other boards, such as the EV-SOMCRR-EZKIT. This connector brings out the signals for I2S, TWI, GPIO, 1.8v power, 3.3v power, VBUS and also is +12v input for the ADZS-AD2428MINI. It can also be used for probing or wiring in other evaluation boards or custom designs.

Signal	Pin	Pin	Signal
GND	1	2	GND
BLCK	3	4	IO7
GND	5	6	GND
SYNC	7	8	IO2
GND	9	10	GND

## Jumpers

Signal	Pin	Pin	Signal
SIO0	11	12	IO1
GND	13	14	GND
SIO1	15	16	IRQ
GND	17	18	GND
SIO2	19	20	A2B_VBUS
GND	21	22	GND
SIO3	23	24	VOUT1
GND	25	26	GND
I2C_SCL	27	28	VOUT2
GND	29	30	GND
I2C_SDA	31	32	VBAT_IN

<i>Part Description</i>	<i>Manufacturer</i>	<i>Part Number</i>
A2B Breakout Header	SAMTEC	TSW-116-08-G-D
<i>Mating Connector</i>		
SSQ-116-01-G-D		

## Jumpers

This section describes functionality of the configuration jumpers. The *Jumper Locations* figure shows the jumper locations.

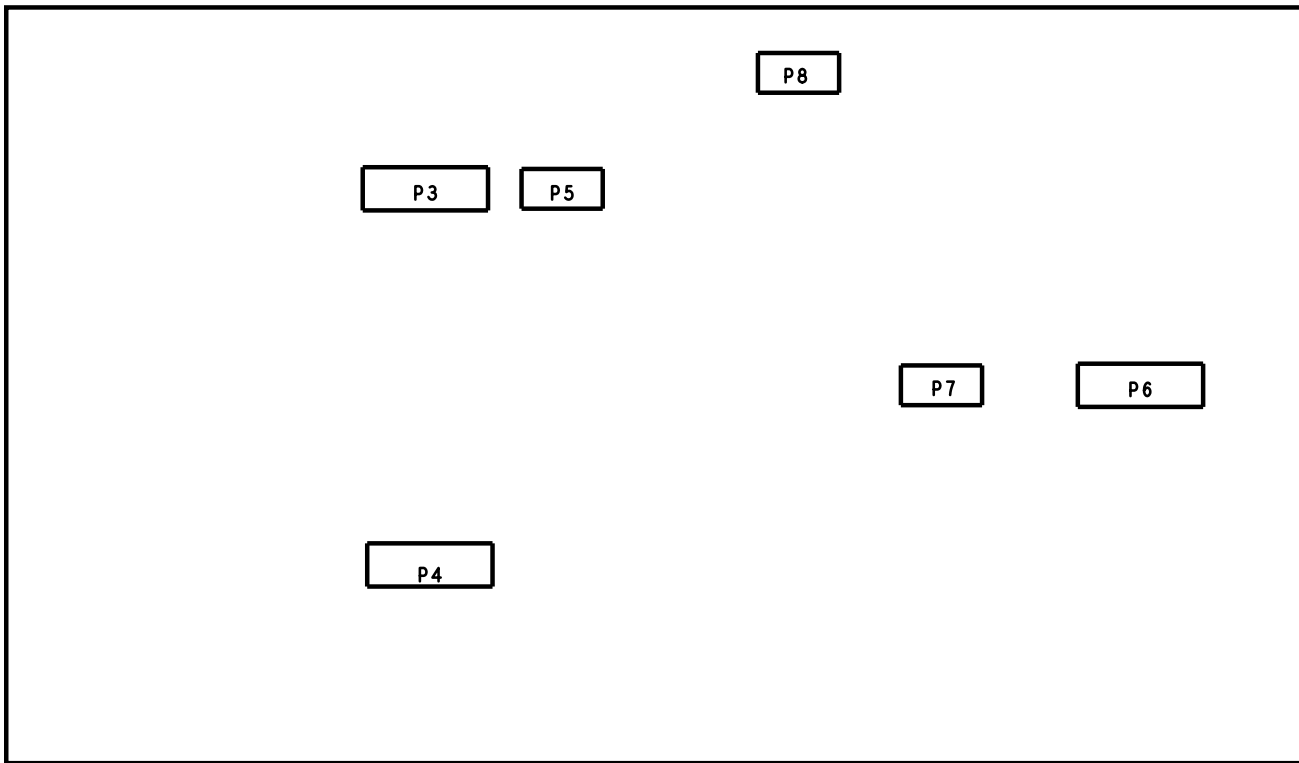

Figure 3-3: Jumpers

### IOVDD( P3 )

The AD2428 supports 1.8v and 3.3v logic on the IO signals. On the ADZS-AD2428MINI board, the IOVDD voltages are supplied from the internal regulators on the AD2428 Transceiver.

To set the IOVDD of the AD2428, set the jumper according to the table below:

Jumper	Voltage	Configuration
P3	1.8v	PIN 1-2
P3	3.3v	PIN 2-3

### I2C Address( P4 )

The AD2428 can have its I2C address changed to allow for multiple AD2428 ICs in a single application.

The ADZS-AD2428MINI supports two I2C addresses with a jumper setting, set the jumpers according to the table below:

Jumper	Address	Configuration
P4	0x6C	PIN 1-2
P4	0x68	PIN 2-3

## Local Power Mode()

The ADZS-AD2428MINI supports multiple modes of the AD2428. Local Power Mode is used for when configuring the AD2428 as a Master node or as a Local Power Slave. In Local Power Mode, 12V is supplied to the LT8620 switching supply from P1 or P2 and it bucked down to 8.5V.

To configure the ADZS-AD2428MINI into Local Power Mode, set the jumpers according to the table below:

Jumper	Configuration
P5	Jumper Removed
P6	PIN 2-3
P7	Jumper Removed
P8	PIN 1-2

## Bus Power Mode()

The ADZS-AD2428MINI supports multiple modes of the AD2428. Bus Power Mode is used for when configuring the AD2428 as a Bus Power Slave node. In this mode, the LT8620 is disabled.

To configure the ADZS-AD2428MINI into Bus Power Mode, set the jumpers according to the table below:

Jumper	Configuration
P5	PIN 1-2
P6	PIN 1-2
P7	PIN 1-2
P8	Jumper Removed

## LEDs

This section describes the on-board LEDs. The *LED Locations* figure shows the LED locations.

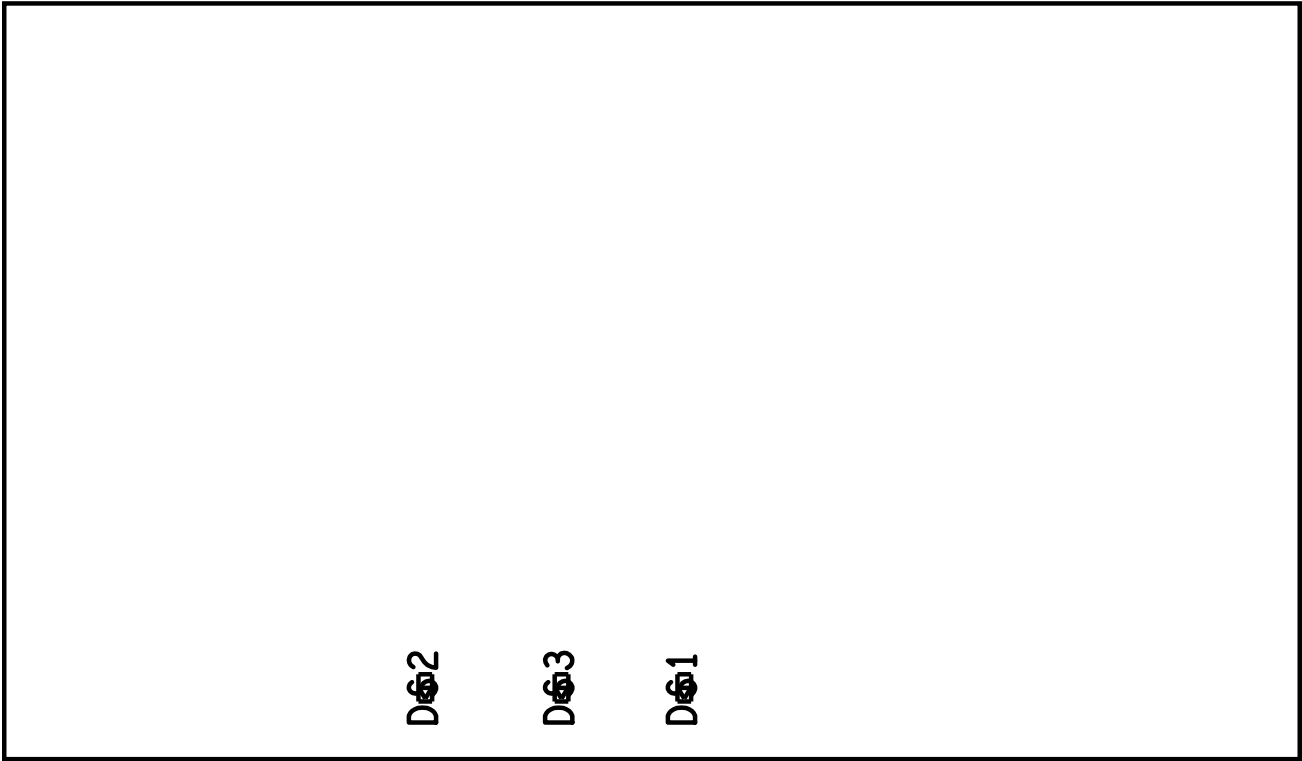

Figure 3-4: LED Locations

### **A<sup>2</sup>B IO1 & IO7 LED ( DS3 and DS1 )**

The A<sup>2</sup>B IO1 and IO7 signals are connected to LEDs on the ADZS-AD2428MINI. Refer to the HRM for further info on using interrupts.



### **A<sup>2</sup>B Interrupt ( DS2 )**

The A<sup>2</sup>B interrupt LED is driven by the AD2428 (add link). The LED is turned on when the IRQ pin drives it high. Refer to the HRM for further info on using interrupts.



## Looking for pricing, stock, or lifecycle information?

Click below to explore more details on WIN SOURCE:

-  [View ADZS-AD2428MINI on WIN SOURCE](#)
-  [Analog Devices Inc. Information](#)

## Optimize Your Supply Chain with WIN SOURCE Solutions

-  Global Sourcing Solution
-  Obsolete Management
-  Cost Control Management
-  Shortage Management
-  Alternative Solution
-  Excess Inventory Management