



**THE DATASHEET OF
ADPA7007C-KIT**



FEATURES

Output P1dB: 31 dBm typical at 22 GHz to 36 GHz

P_{SAT}: 32 dBm typical at 22 GHz to 36 GHz

Gain: 21.5 dB typical at 22 GHz to 36 GHz

Output IP3: 41 dBm typical at 22 GHz to 44 GHz

Supply voltage: 5 V typical at 1400 mA maximum

50 Ω matched input and output

Die size: 3.610 mm × 3.610 mm × 0.102 mm

APPLICATIONS

Military and space

Test instrumentation

GENERAL DESCRIPTION

The ADPA7007CHIP is a gallium arsenide (GaAs), pseudomorphic high electron mobility transistor (pHEMT), monolithic microwave integrated circuit (MMIC), distributed power amplifier that operates from 18 GHz to 44 GHz. The amplifier provides a gain of 21.5 dB, an output power for 1 dB compression (P1dB) of 31 dBm, and a typical output third-

order intercept (IP3) of 41 dBm. The ADPA7007CHIP requires 1400 mA from a 5 V supply on the supply voltage (V_{DD}) and features inputs and outputs that are internally matched to 50 Ω, facilitating integration into multichip modules (MCMs). All data was taken with the chip connected via two 0.025 mm wire bonds that are at least 0.31 mm long.

FUNCTIONAL BLOCK DIAGRAM

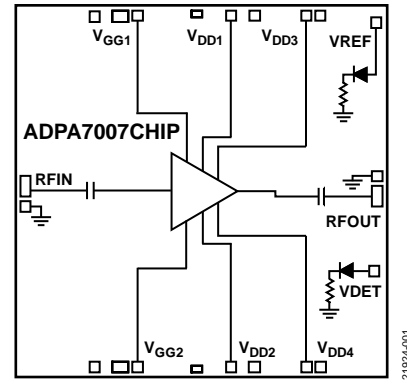

Figure 1.

TABLE OF CONTENTS

Features	1	Constant I _{DD} Operation	15
Applications	1	Theory of Operation	16
Functional Block Diagram	1	Applications Information	17
General Description	1	Mounting and Bonding Techniques for Millimeterwave GaAs MMICs	18
Revision History	2	Biasing ADPA7007CHIP with the HMC980LP4E	19
Specifications	3	Application Circuit Setup	19
18 GHz to 22 GHz Frequency Range	3	Limiting VGATE for ADPA7007CHIP V _{GGx} Absolute Maximum Rating Requirement	19
22 GHz to 36 GHz Frequency Range	3	HMC980LP4E Bias Sequence	21
36 GHz to 44 GHz Frequency Range	4	Constant Drain Current Biasing vs. Constant Gate Voltage Biasing	21
Absolute Maximum Ratings	5	Typical Application Circuit	23
Thermal Resistance	5	Assembly Diagram	24
Electrostatic Discharge (ESD) Ratings	5	Outline Dimensions	25
ESD Caution	5	Ordering Guide	25
Pin Configuration and Function Descriptions	6		
Interface Schematics	7		
Typical Performance Characteristics	8		

REVISION HISTORY

4/2020—Revision 0: Initial Version

SPECIFICATIONS**18 GHz TO 22 GHz FREQUENCY RANGE**

$T_A = 25^\circ\text{C}$, $V_{DD} = 5\text{ V}$, and quiescent supply current (I_{DQ}) = 1400 mA for nominal operation, unless otherwise noted.

Table 1.

Parameter	Symbol	Min	Typ	Max	Unit	Test Conditions/Comments
FREQUENCY RANGE		18		22	GHz	
GAIN		20	23		dB	
Gain Flatness			± 0.1		dB	
Gain Variation Over Temperature			0.011		dB/ $^\circ\text{C}$	
NOISE FIGURE			6.5		dB	
RETURN LOSS						
Input			15.5		dB	
Output			26.5		dB	
OUTPUT						
Output Power for 1 dB Compression	P1dB	26	28.5		dBm	Measurement taken at output power (P_{OUT}) per tone = 16 dBm
Saturated Output Power	P_{SAT}		30		dBm	
Output Third-Order Intercept	IP3		37		dBm	
SUPPLY						
Quiescent Current	I_{DQ}		1400		mA	Adjust the gate bias voltage (V_{GG1} and V_{GG2}) between -1.5 V up to 0 V to achieve the desired I_{DQ}
Voltage	V_{DD}	4	5		V	

22 GHz TO 36 GHz FREQUENCY RANGE

$T_A = 25^\circ\text{C}$, $V_{DD} = 5\text{ V}$, and $I_{DQ} = 1400\text{ mA}$ for nominal operation, unless otherwise noted.

Table 2.

Parameter	Symbol	Min	Typ	Max	Unit	Test Conditions/Comments
FREQUENCY RANGE		22		36	GHz	
GAIN		19.5	21.5		dB	
Gain Flatness			± 1.4		dB	
Gain Variation Over Temperature			0.026		dB/ $^\circ\text{C}$	
NOISE FIGURE			5.5		dB	
RETURN LOSS						
Input			17		dB	
Output			22		dB	
OUTPUT						
Output Power for 1 dB Compression	P1dB	29	31		dBm	Measurement taken at P_{OUT} per tone = 16 dBm
Saturated Output Power	P_{SAT}		32		dBm	
Output Third-Order Intercept	IP3		41		dBm	
SUPPLY						
Quiescent Current	I_{DQ}		1400		mA	Adjust the (V_{GG1} and V_{GG2}) between -1.5 V up to 0 V to achieve the desired I_{DQ}
Voltage	V_{DD}	4	5		V	

36 GHz TO 44 GHz FREQUENCY RANGE

$T_A = 25^\circ\text{C}$, $V_{DD} = 5\text{ V}$, and $I_{DQ} = 1400\text{ mA}$ for nominal operation, unless otherwise noted.

Table 3.

Parameter	Symbol	Min	Typ	Max	Unit	Test Conditions/Comments
FREQUENCY RANGE		36		44	GHz	
GAIN		18	21		dB	
Gain Flatness			± 0.7		dB	
Gain Variation Over Temperature			0.039		dB/ $^\circ\text{C}$	
NOISE FIGURE			6.5		dB	
RETURN LOSS						
Input			21		dB	
Output			18		dB	
OUTPUT						
Output Power for 1 dB Compression	P1dB	27	30		dBm	
Saturated Output Power	P_{SAT}		31.5		dBm	
Output Third-Order Intercept	IP3		41		dBm	Measurement taken at P_{OUT} per tone = 16 dBm
SUPPLY						
Quiescent Current	I_{DQ}		1400		mA	Adjust (V_{GG1} and V_{GG2}) between -1.5 V up to 0 V to achieve the desired I_{DQ}
Voltage	V_{DD}	4	5		V	

ABSOLUTE MAXIMUM RATINGS

Table 4.

Parameter	Rating
Drain Bias Voltage (V_{DDx})	6.0 V
V_{GGx}	-1.5 to 0 V
RF Input Power (RFIN)	18 dBm
Continuous Power Dissipation (P_{DISS}), $T_A = 85^\circ\text{C}$ (Derate 149.2 mW/ $^\circ\text{C}$ Above 85°C)	13.6 W
Temperature Range	
Storage	-65 $^\circ\text{C}$ to +150 $^\circ\text{C}$
Operating	-55 $^\circ\text{C}$ to +85 $^\circ\text{C}$

Stresses at or above those listed under Absolute Maximum Ratings may cause permanent damage to the product. This is a stress rating only; functional operation of the product at these or any other conditions above those indicated in the operational section of this specification is not implied. Operation beyond the maximum operating conditions for extended periods may affect product reliability.

THERMAL RESISTANCE

Thermal performance is directly linked to system design and operating environment. Careful attention to the printed circuit board (PCB) thermal design is required.

θ_{JC} is the channel to case thermal resistance, channel to bottom of die using die attach epoxy.

Table 5. Thermal Resistance

Package Type	θ_{JC}	Unit
C-10-11	6.6	$^\circ\text{C}/\text{W}$

Table 6. Reliability Information

Parameter	Temperature ($^\circ\text{C}$)
Junction Temperature to Maintain 1,000,000 Hour Mean Time to Failure (MTTF)	175
Nominal Junction Temperature ($T_J = 85^\circ\text{C}$, $V_{DD} = 5\text{ V}$, $I_{DQ} = 1400\text{ mA}$)	131.2

ELECTROSTATIC DISCHARGE (ESD) RATINGS

The following ESD information is provided for handling of ESD-sensitive devices in an ESD protected area only.

Human body model (HBM) per ANSI/ESDA/JEDDEC JS-001.

ESD Ratings ADPA7007CHIP

Table 7. ADPA7007CHIP, 10-Pad CHIP

ESD Model	Withstand Threshold (V)	Class
HBM	± 250	1A

ESD CAUTION



ESD (electrostatic discharge) sensitive device. Charged devices and circuit boards can discharge without detection. Although this product features patented or proprietary protection circuitry, damage may occur on devices subjected to high energy ESD. Therefore, proper ESD precautions should be taken to avoid performance degradation or loss of functionality.

PIN CONFIGURATION AND FUNCTION DESCRIPTIONS

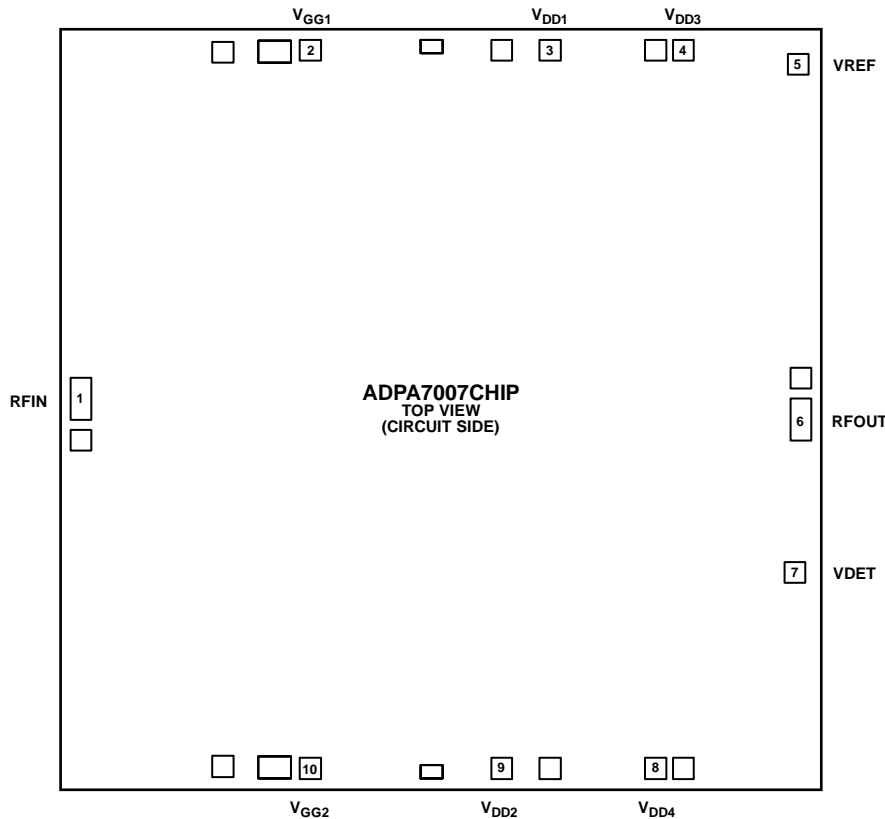

Figure 2. Pin Configuration

21924-002

Table 8. Pin Function Descriptions

Pin No.	Mnemonic	Description
1	RFIN	RF Signal Input. This pad is ac-coupled and matched to 50 Ω.
2, 10	V _{GG1} , V _{GG2}	Amplifier Gate Controls. External bypass capacitors of 4.7 μF, 0.01 μF, and 100 pF are required for these pads. ESD protection diodes are included and turn on below -1.5 V.
3, 4, 8, 9,	V _{DD1} , V _{DD3} , V _{DD4} , V _{DD2}	Drain Biases for the Amplifier. External bypass capacitors of 4.7 μF, 0.01 μF, and 100 pF are required for these pads.
5	VREF	Reference Diode Voltage. Use this pad for temperature compensation of the VDET RF output power measurements. Used in combination with VDET, this voltage provides temperature compensation to the VDET RF output power measurements.
6	RFOUT	RF Signal Output. This pad is ac-coupled and matched to 50 Ω.
7	VDET	Detector Diode Used for Measuring the RF Output Power. Detection via this pad requires the application of a dc bias voltage through an external series resistor. Used in combination with VREF, the difference voltage, VREF - VDET, is a temperature compensated dc voltage proportional to the RF output power.
Die Bottom	GND	Die bottom must be connected to RF and dc ground.

INTERFACE SCHEMATICS



Figure 3. GND Interface Schematic

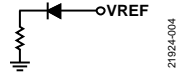

Figure 4. VREF Interface Schematic

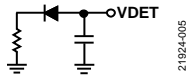

Figure 5. VDET Interface Schematic

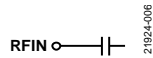

Figure 6. RFIN Interface Schematic

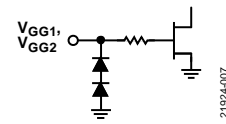

Figure 7. VGG1, VGG2 Interface Schematic

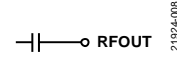

Figure 8. RFOUT Interface Schematic

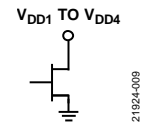

Figure 9. VDD1 to VDD4 Interface Schematic

TYPICAL PERFORMANCE CHARACTERISTICS

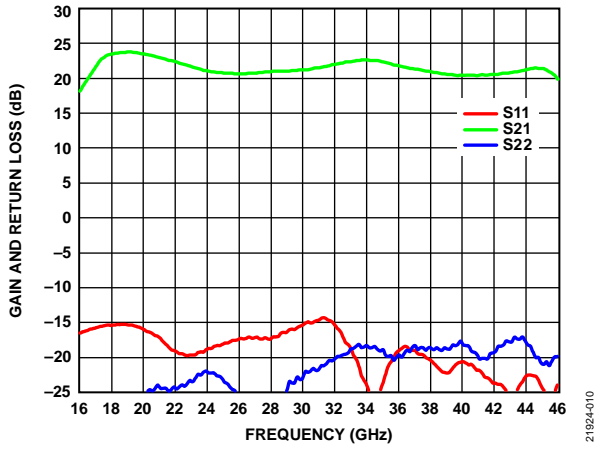

Figure 10. Gain and Return Loss vs. Frequency, $V_{DD} = 5\text{ V}$, $I_{DQ} = 1400\text{ mA}$ (S11 Is the Input Return Loss, S21 Is the Gain, and S22 is the Output Return Loss)

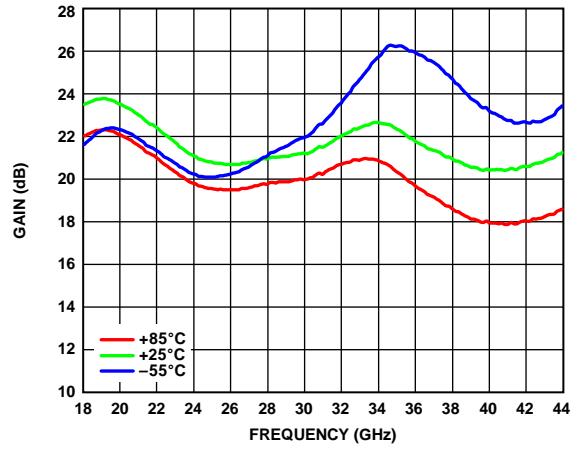

Figure 13. Gain vs. Frequency for Various Temperatures, $V_{DD} = 5\text{ V}$, $I_{DQ} = 1400\text{ mA}$

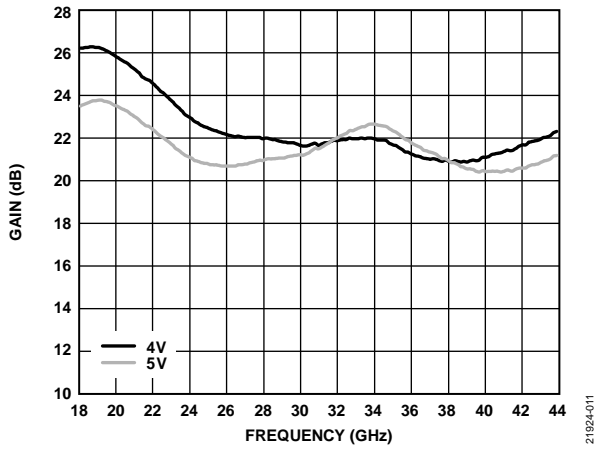

Figure 11. Gain vs. Frequency for Various Supply Voltages, $I_{DQ} = 1400\text{ mA}$

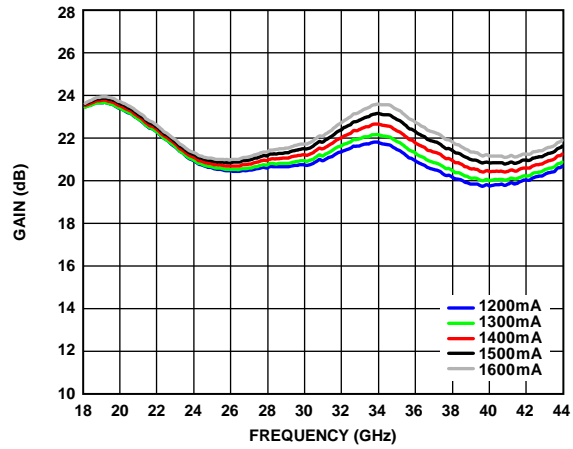

Figure 14. Gain vs. Frequency for Various Supply Currents, $V_{DD} = 5\text{ V}$

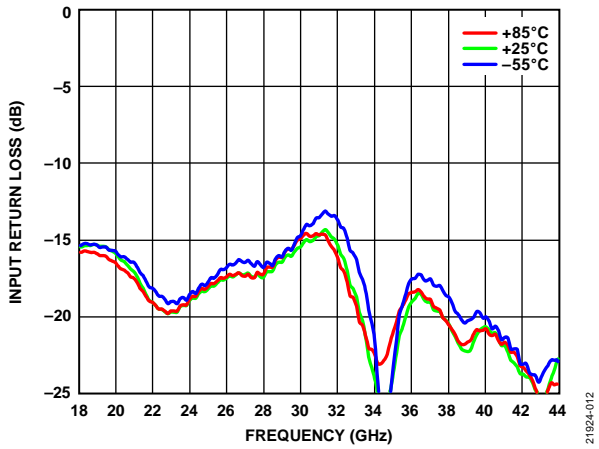

Figure 12. Input Return Loss vs. Frequency for Various Temperatures, $V_{DD} = 5\text{ V}$, $I_{DQ} = 1400\text{ mA}$

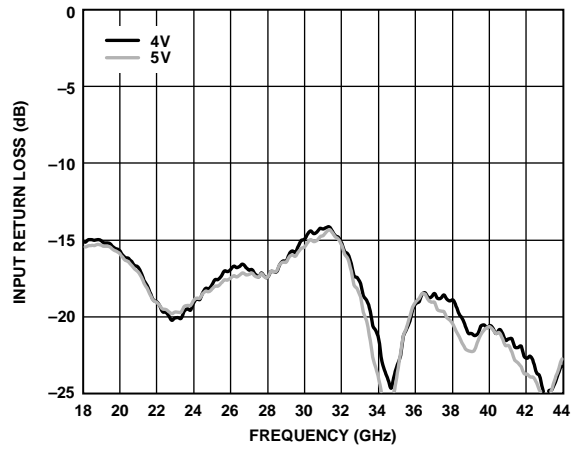

Figure 15. Input Return Loss vs. Frequency for Various Supply Voltages, $I_{DQ} = 1400\text{ mA}$

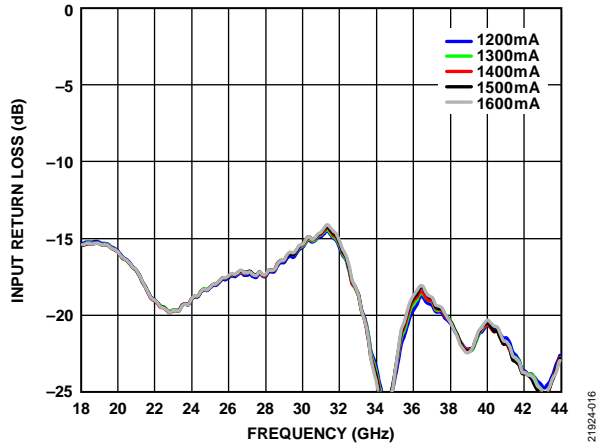

Figure 16. Input Return Loss vs. Frequency for Various Supply Currents, $V_{DD} = 5V$

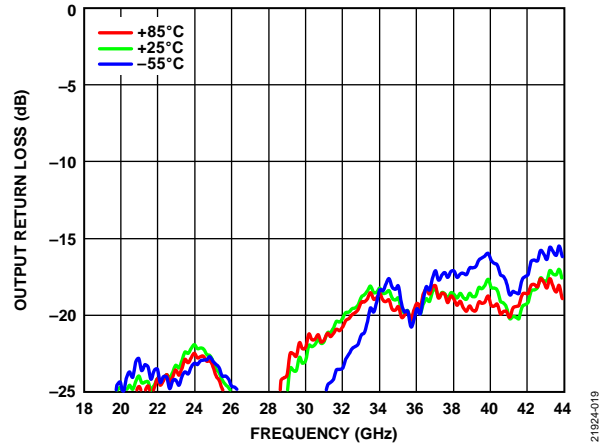

Figure 19. Output Return Loss vs. Frequency for Various Temperature, $V_{DD} = 5V, I_{DQ} = 1400mA$

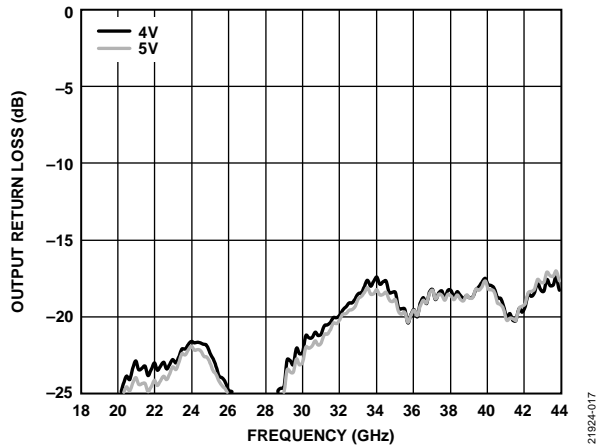

Figure 17. Output Return Loss vs. Frequency for Various Supply Voltages, $I_{DQ} = 1400mA$

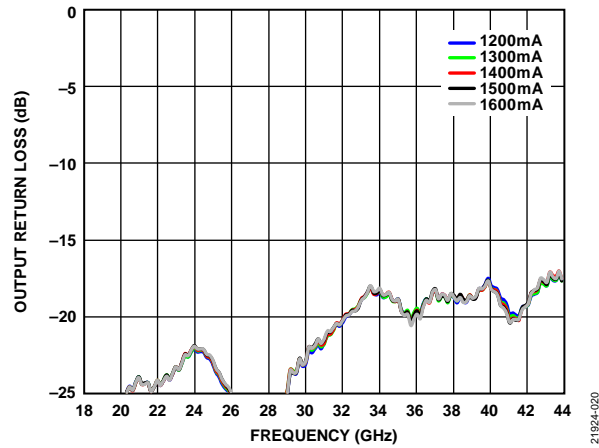

Figure 20. Output Return Loss vs. Frequency for Various Supply Currents, $V_{DD} = 5V$

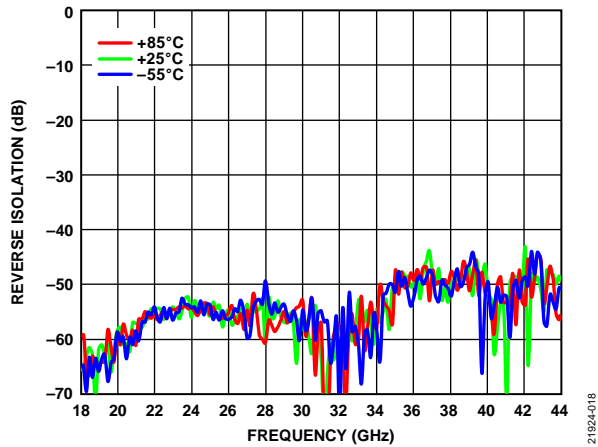

Figure 18. Reverse Isolation vs. Frequency for Various Temperatures, $V_{DD} = 5V, I_{DQ} = 1400mA$

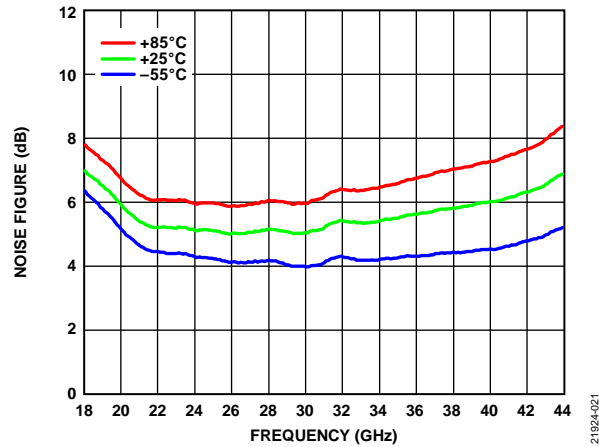

Figure 21. Noise Figure vs. Frequency for Various Temperatures, $V_{DD} = 5V, I_{DQ} = 1400mA$

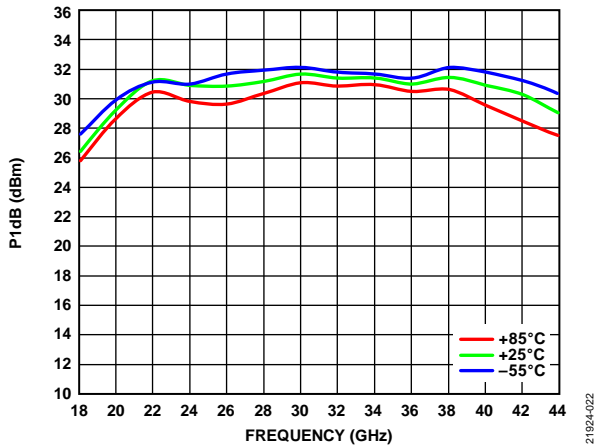

Figure 22. P1dB vs. Frequency for Various Temperatures, $V_{DD} = 5V, I_{DQ} = 1400\text{ mA}$

21924-022

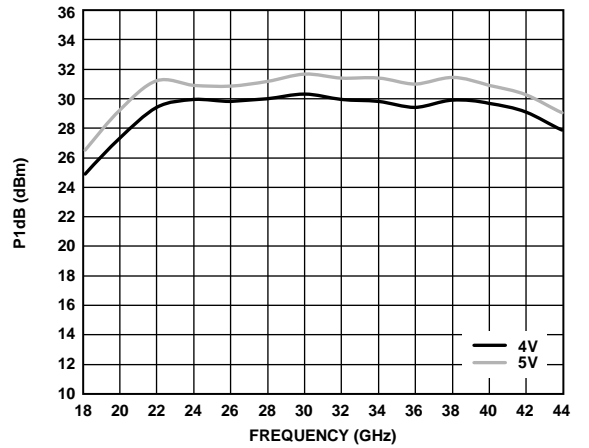

Figure 25. P1dB vs. Frequency for Various Supply Voltages, $I_{DQ} = 1400\text{ mA}$

21924-025

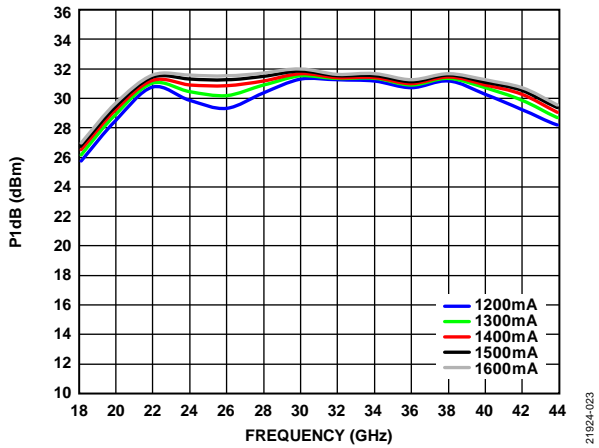

Figure 23. P1dB vs. Frequency for Various Supply Currents, $V_{DD} = 5V$

21924-023

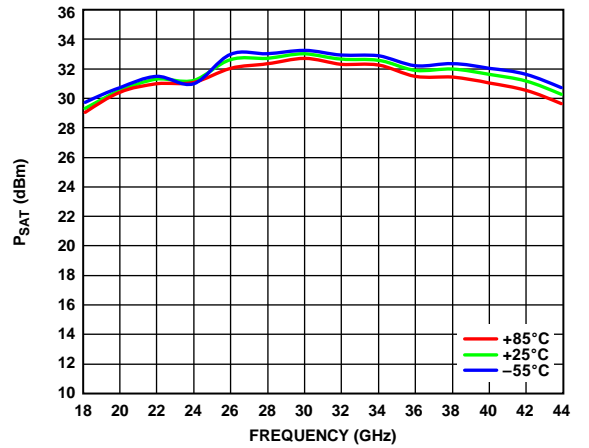

Figure 26. P_{SAT} vs. Frequency for Various Temperatures, $V_{DD} = 5V, I_{DQ} = 1400\text{ mA}$

21924-026

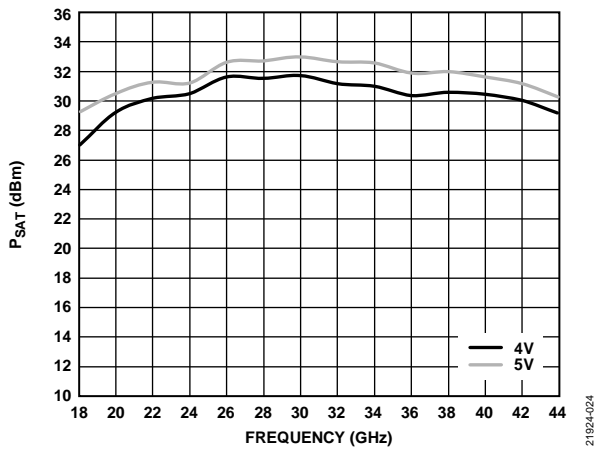

Figure 24. Saturated Output Power (P_{SAT}) vs. Frequency for Various Supply Voltages, $I_{DQ} = 1200\text{ mA}$

21924-024

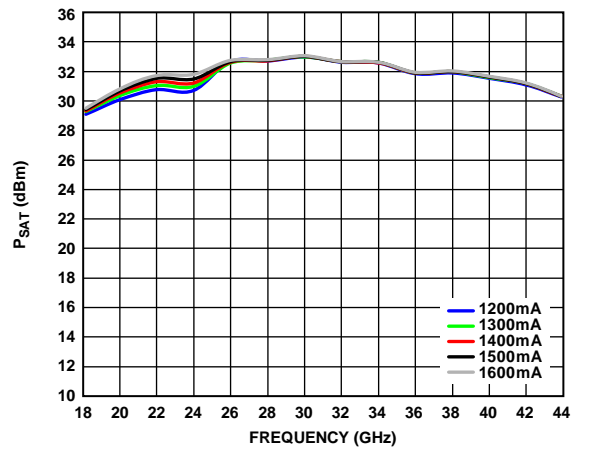

Figure 27. P_{SAT} vs. Frequency for Various Supply Currents, $V_{DD} = 5V$

21924-027

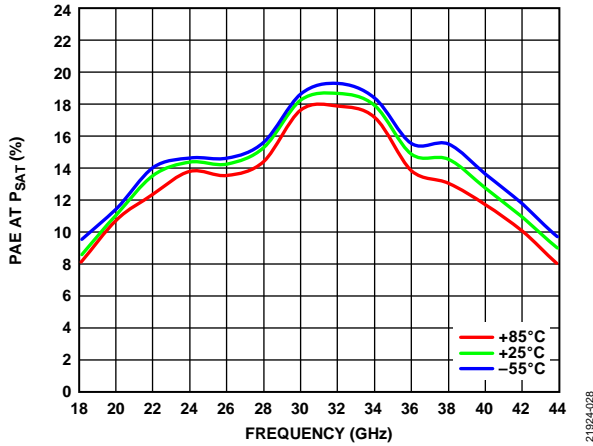

Figure 28. Power Added Efficiency (PAE) at P_{SAT} vs. Frequency for Various Temperatures, $V_{DD} = 5V$, $I_{DQ} = 1400mA$

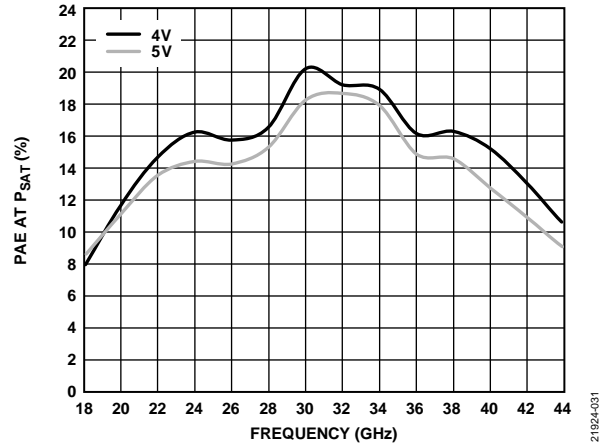

Figure 31. PAE at P_{SAT} vs. Frequency for Various Supply Voltages, $I_{DQ} = 1400mA$

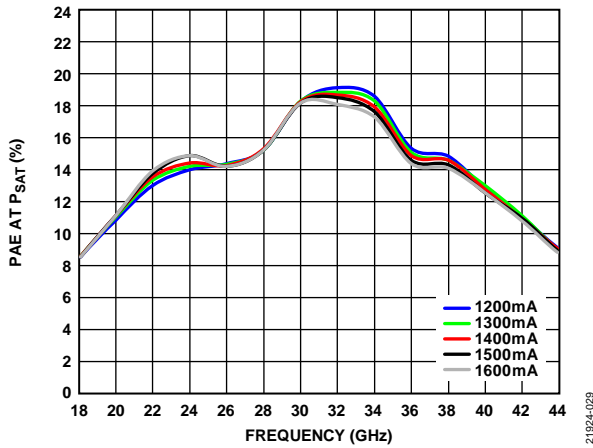

Figure 29. PAE at P_{SAT} vs. Frequency for Various Supply Currents, $V_{DD} = 5V$

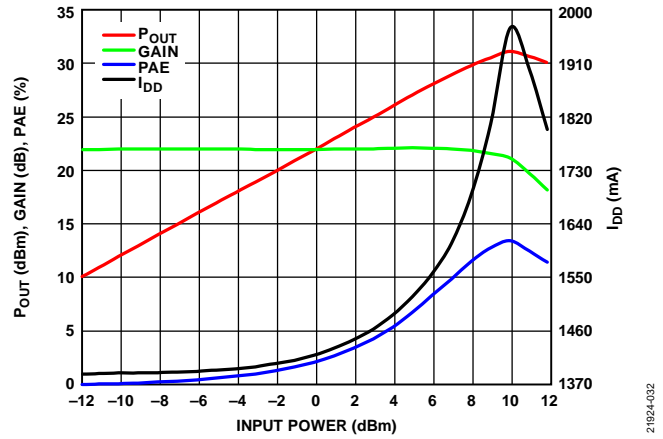

Figure 32. P_{OUT} , Gain, PAE, and I_{DD} vs. Input Power, 22 GHz, $V_{DD} = 5V$, $I_{DD} = 1400mA$

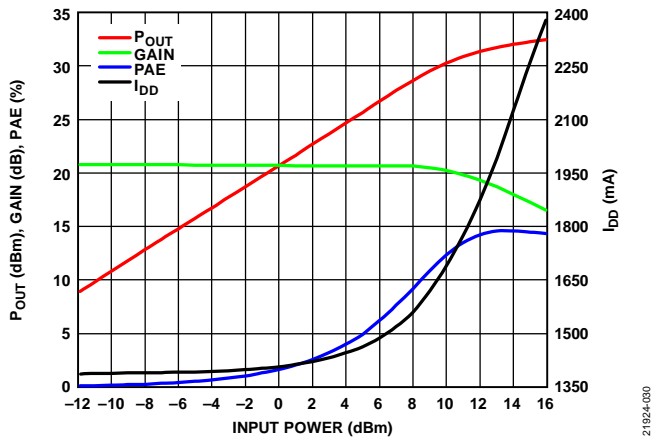

Figure 30. P_{OUT} , Gain, PAE, Drain Current with RF Applied (I_{DD}) vs. Input Power, 26 GHz, $V_{DD} = 5V$, $I_{DD} = 1400mA$

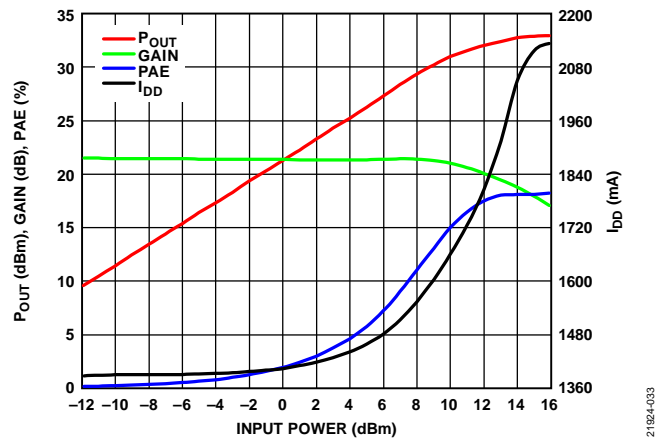

Figure 33. P_{OUT} , Gain, PAE, and I_{DD} vs. Input Power, 30 GHz, $V_{DD} = 5V$, $I_{DD} = 1400mA$

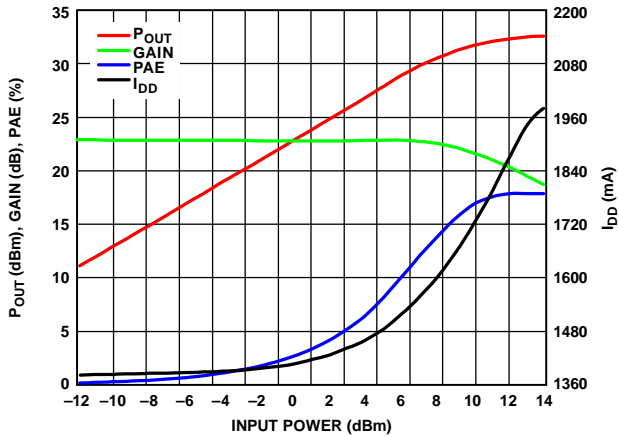

Figure 34. P_{OUT} , Gain, PAE, and I_{DD} vs. Input Power, 34 GHz, $V_{DD} = 5 V$, $I_{DD} = 1400 mA$

21924-034

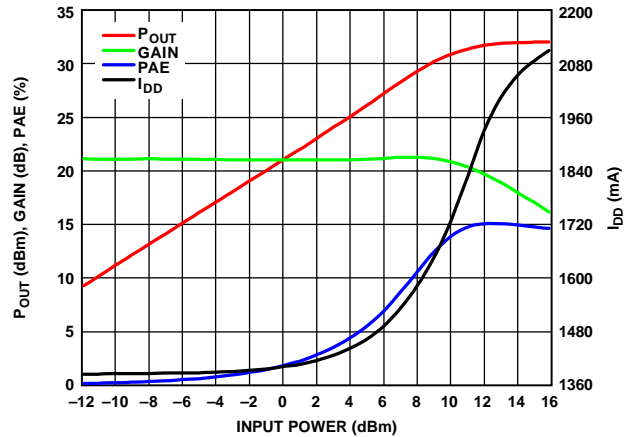

Figure 37. P_{OUT} , Gain, PAE, and I_{DD} vs. Input Power, 38 GHz, $V_{DD} = 5 V$, $I_{DD} = 1400 mA$

21924-037

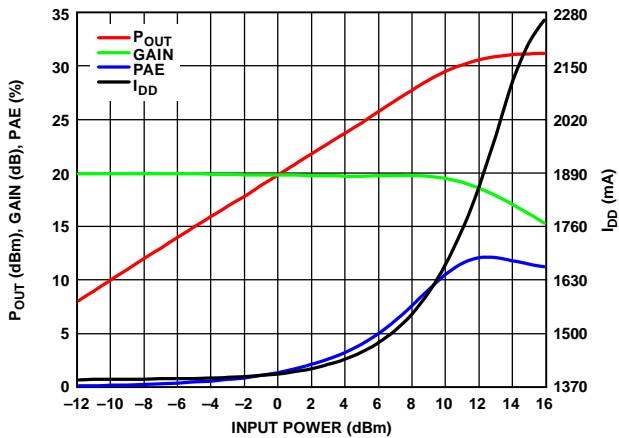

Figure 35. P_{OUT} , Gain, PAE, and I_{DD} vs. Input Power, 42 GHz, $V_{DD} = 5 V$, $I_{DD} = 1400 mA$

21924-035

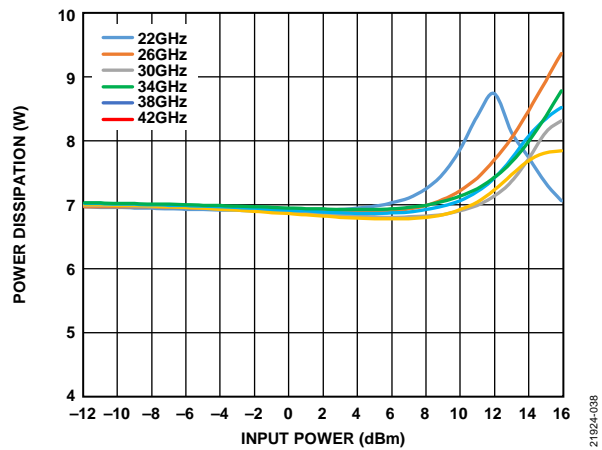

Figure 38. Power Dissipation vs. Input Power for Various Frequencies at $T_A = 85^\circ C$, $V_{DD} = 5 V$, $I_{DD} = 1400 mA$

21924-038

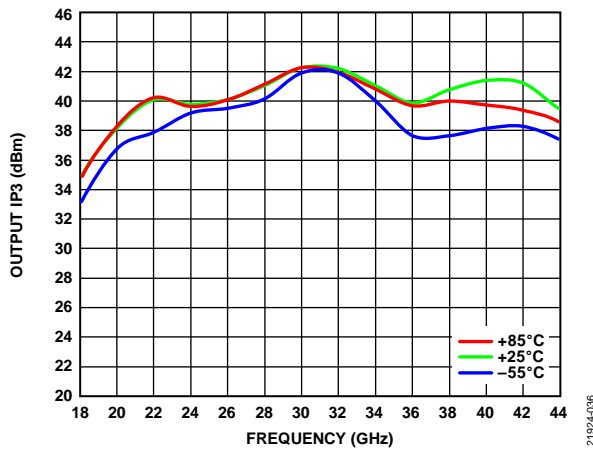

Figure 36. Output IP3 vs. Frequency for Various Temperatures, P_{OUT} per Tone = 16 dBm, $V_{DD} = 5 V$, $I_{DQ} = 1400 mA$

21924-036

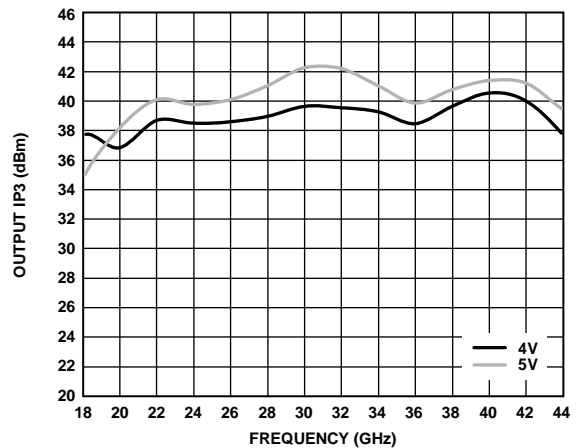

Figure 39. Output IP3 vs. Frequency for Various Supply Voltages, P_{OUT} per Tone = 14 dBm, $V_{DD} = 5 V$, $I_{DQ} = 1400 mA$

21924-039

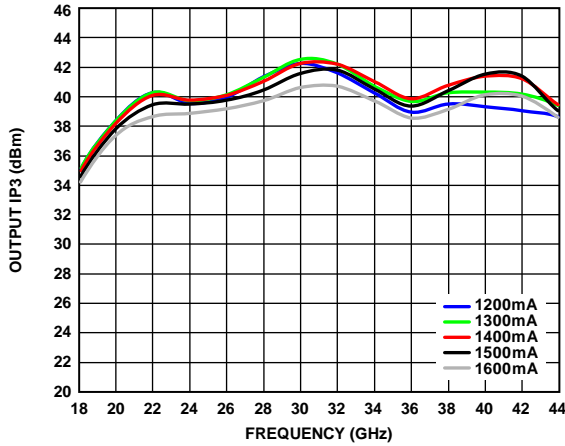

Figure 40. Output IP3 vs. Frequency for Various Supply Currents, P_{OUT} per Tone = 16 dBm, $V_{DD} = 5$ V

21924-040

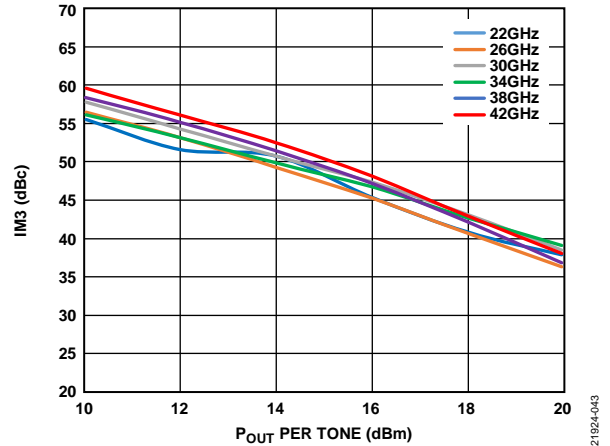

Figure 43. IM3 Distortion Relative to Carrier vs. P_{OUT} per Tone, $V_{DD} = 4$ V, $I_{DQ} = 1400$ mA

21924-043

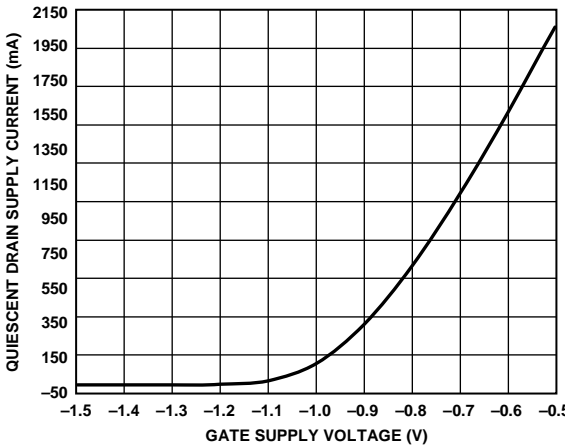

Figure 41. Quiescent Drain Supply Current vs. Gate Supply Voltage

21924-041

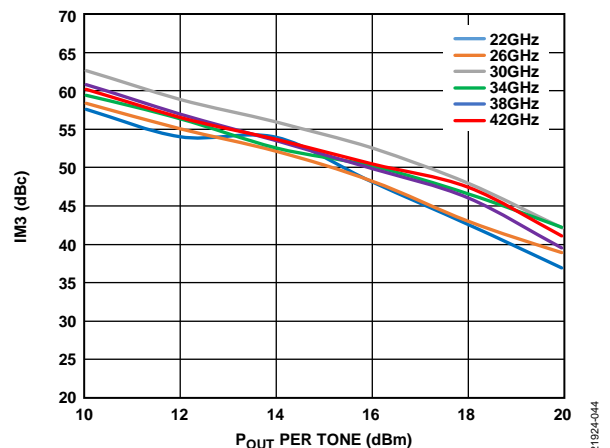

Figure 44. IM3 Distortion Relative to Carrier vs. P_{OUT} per Tone, $V_{DD} = 5$ V, $I_{DQ} = 1400$ mA

21924-044

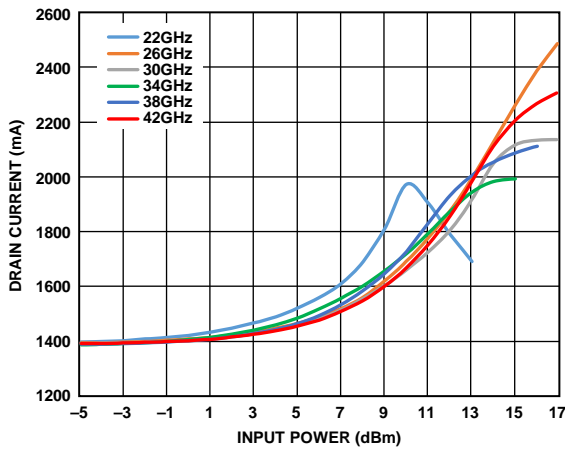

Figure 42. Drain Current vs. Input Power at Various Frequencies, $V_{DD} = 5$ V, $I_{DQ} = 1400$ mA

21924-042

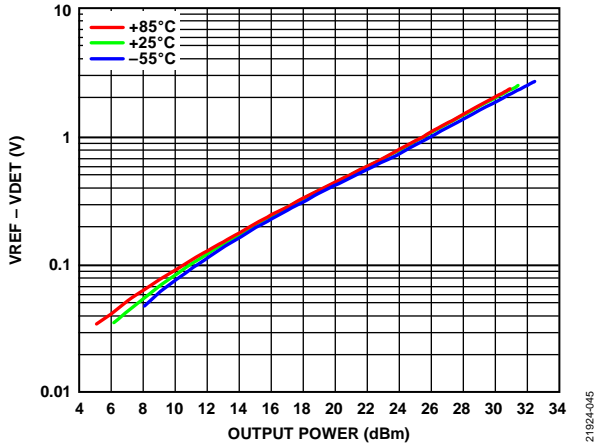

Figure 45. Detector Voltage (VREF - VDET) vs. Output Power for Various Temperatures at 32 GHz

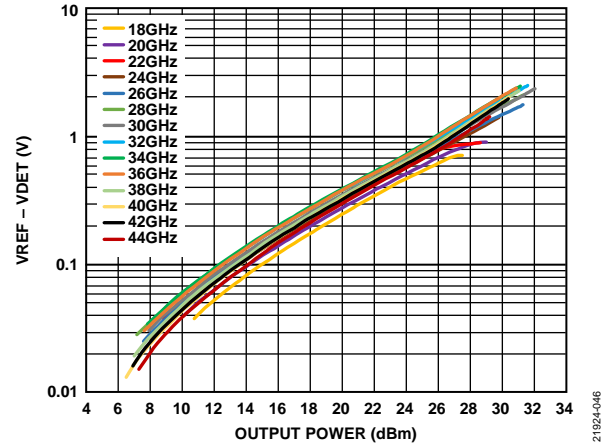

Figure 46. Detector Voltage (VREF - VDET) vs. Output Power for Various Frequencies

CONSTANT I_{DD} OPERATION

$T_A = 25^\circ\text{C}$, $V_{DD} = 5\text{ V}$, and $I_{DQ} = 1600\text{ mA}$ for nominal operation, unless otherwise noted. Figure 47 to Figure 50 are biased with HMC980LP4E active bias controller. See the Biasing ADPA7007CHIP with the HMC980LP4E section for biasing details.

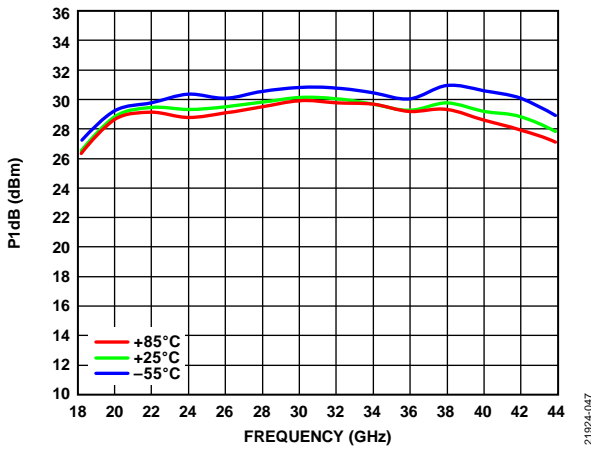

Figure 47. P1dB vs. Frequency for Various Temperatures, $V_{DD} = 5\text{ V}$, Data Measured with Constant I_{DD}

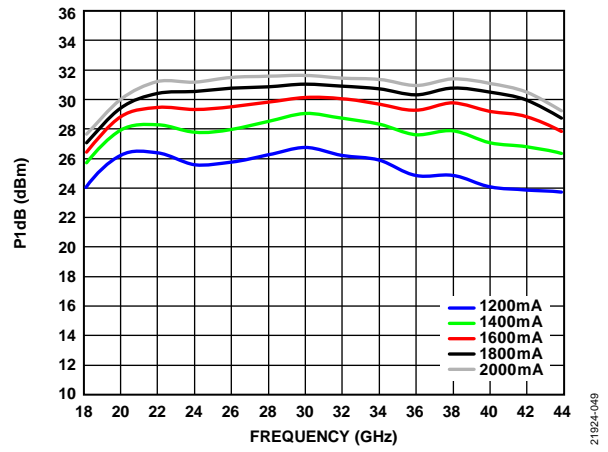

Figure 49. P1dB vs. Frequency for Various Drain Currents, $V_{DD} = 5\text{ V}$, Data Measured with Constant I_{DD}

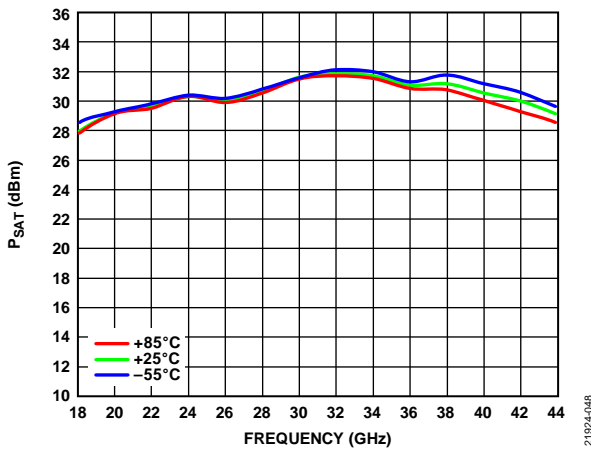

Figure 48. P_{SAT} vs. Frequency for Various Temperatures, $V_{DD} = 5\text{ V}$, Data Measured with Constant I_{DD}

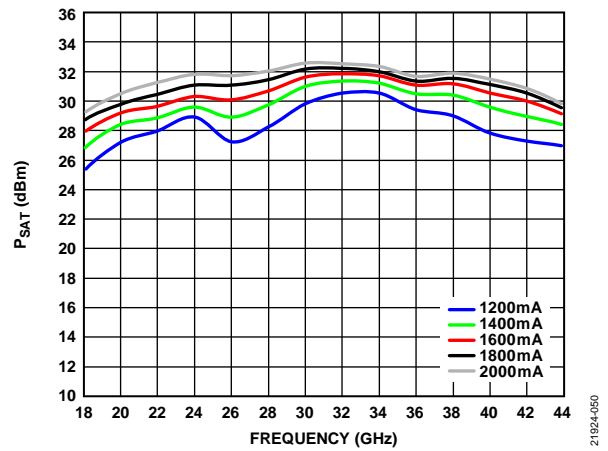

Figure 50. P_{SAT} vs. Frequency for Various Drain Currents, $V_{DD} = 5\text{ V}$, Data Measured with Constant I_{DD}

THEORY OF OPERATION

The architecture of the ADPA7007CHIP, a medium power amplifier, is shown in Figure 51. The ADPA7007CHIP uses two cascaded, four-stage amplifiers operating in quadrature between six 90° hybrids.

The input signal is divided evenly into two, and then each signal is divided into two again. Each of these new paths are amplified through three independent gain stages. The amplified signals are then combined at the output. This balanced amplifier approach forms an amplifier with a combined gain of 21.5 dB and a P_{SAT} value of 32 dBm.

A portion of the RF output signal is directionally coupled to a diode for detection of the RF output power. When the diode is dc biased, the diode rectifies the RF power and makes the RF power available for measurement as a dc voltage at VDET. To allow temperature compensation of VDET, an identical and symmetrically located circuit, minus the coupled RF power, is available via VREF. Taking the difference of $VREF - VDET$ provides a temperature compensated signal that is proportional to the RF output (see Figure 51).

The 90° hybrids ensure that the input and output return losses are greater than 14 dB. See the application circuits shown in Figure 64 and Figure 65 for further details on biasing the various blocks.

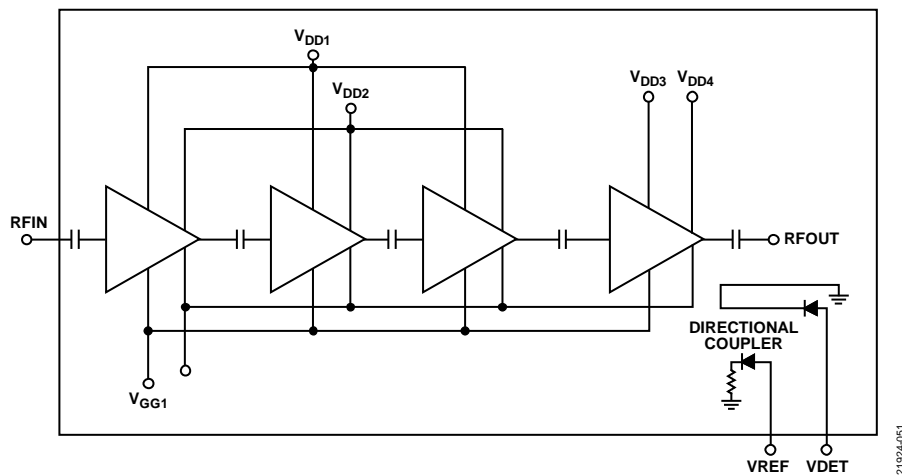

Figure 51. ADPA7007CHIP Architecture

APPLICATIONS INFORMATION

The ADPA7007CHIP is a GaAs, pHEMT, MMIC power amplifier. Capacitive bypassing is required for all V_{GGx} and V_{DDx} pins (see Figure 52). V_{GG1} is the gate bias pad for the top cascaded amplifiers. V_{GG2} is the gate bias pad for the bottom cascaded amplifiers. V_{DD1} and V_{DD3} are drain bias pads for the top cascaded amplifiers. V_{DD2} and V_{DD4} are drain bias pads for the bottom cascaded amplifiers.

All measurements for this device were taken using the typical application circuit (see Figure 64) and were configured as shown in the assembly diagram (see Figure 65).

The following is the recommended bias sequence during power-up:

1. Connect GND to RF and dc ground.
2. Set all the gate bias voltages, V_{GG1} and V_{GG2} , to -2 V.
3. Set all the drain bias voltages, V_{DDx} , to 5 V.
4. Increase the gate bias voltages to achieve a quiescent supply current of 1400 mA.
5. Apply the RF signal.

The following is the recommended bias sequence during power-down:

1. Turn off the RF signal.
2. Decrease the gate bias voltages, V_{GG1} and V_{GG2} , to -2 V to achieve a $I_{DQ} = 0$ mA (approximately).
3. Decrease all of the drain bias voltages to 0 V.
4. Increase the gate bias voltages to 0 V.

Simplified bias pad connections to dedicated gain stages and dependence and independence among pads are shown in Figure 52.

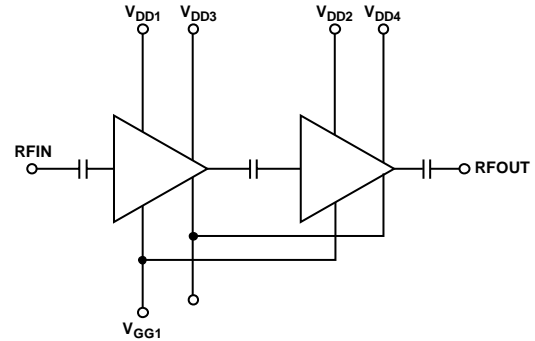

Figure 52. Simplified Block Diagram

The $V_{DD} = 5$ V and $I_{DD} = 1400$ mA bias conditions are recommended to optimize overall performance. Unless otherwise noted, the data shown was taken using the recommended bias conditions. Operation of the ADPA7007CHIP at different bias conditions may provide performance that differs from what is shown in Table 1, Table 2, and Table 3. Biasing the ADPA7007CHIP for higher drain current typically results in higher P1dB, output IP3, and gain at the expense of increased power consumption (see Table 9).

Table 9. Power Selection Table^{1,2}

I_{DQ} (mA)	Gain (dB)	P1dB (dBm)	Output IP3 (dBm)	P_{DISS} (W)	V_{GGx} (V)
1200	21.7	30.7	38.9	5.9	-0.62
1300	22.1	30.9	39.7	6.4	-0.59
1400	22.6	31.0	39.8	6.8	-0.56
1500	23.1	31.1	39.4	7.3	-0.54
1600	23.5	31.2	38.6	7.7	-0.51

¹ Data taken at the following nominal bias conditions: $V_{DD} = 5$ V and $T_A = 25^\circ\text{C}$.

² Adjust V_{GG1} and V_{GG2} from -1.5 V to 0 V to achieve the desired drain current.

MOUNTING AND BONDING TECHNIQUES FOR MILLIMETERWAVE GAAS MMICS

Attach the die directly to the ground plane with conductive epoxy (see the Handling Precautions section, the Mounting section, and the Wire Bonding section).

Microstrip, 50 Ω transmission lines on 0.127 mm thick alumina thin film substrates are recommended for bringing the RF to and from the chip. Raise the die 0.075 mm to ensure that the surface of the die is coplanar with the surface of the substrate.

Place the microstrip substrates as close to the die as possible to minimize ribbon bond length. Typical die to substrate spacing is 0.076 mm to 0.152 mm. To ensure wideband matching, a 15 fF capacitive stub is recommended on the PCB before the ribbon bond.

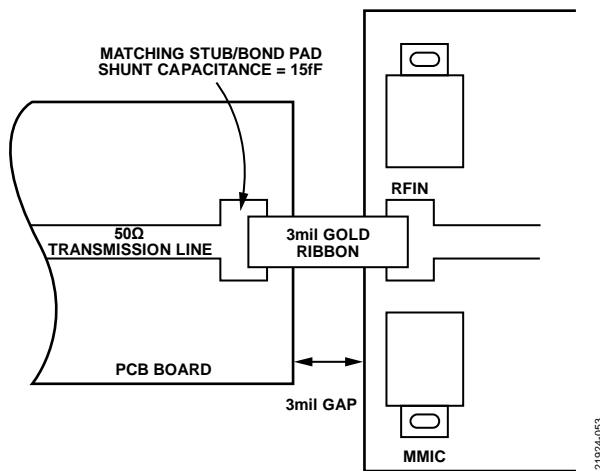

Figure 53. High Frequency Input Wideband Matching

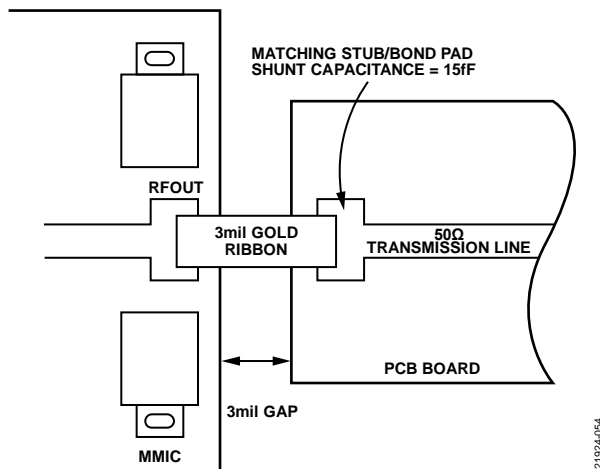

Figure 54. High Frequency Output Wideband Matching

Handling Precautions

To avoid permanent damage, follow these storage, cleanliness, static sensitivity, transient, and general handling precautions:

- Place all bare die in either waffle or gel-based ESD protective containers and then seal the die in an ESD protective bag for shipment. After the sealed ESD protective bag is opened, store all die in a dry nitrogen environment.
- Handle the chips in a clean environment. Do not attempt to clean the chip using liquid cleaning systems.
- Follow ESD precautions to protect against ESD strikes.
- While bias is applied, suppress instrument and bias supply transients. Use shielded signal and bias cables to minimize inductive pickup.
- Handle the chip along the edges with a vacuum collet or with a sharp pair of tweezers. The surface of the chip has fragile air bridges and must not be touched with a vacuum collet, tweezers, or fingers.

Mounting

Before the epoxy die is attached, apply a minimum amount of epoxy to the mounting surface so that a thin epoxy fillet is observed around the perimeter of the chip after it is placed into position. Cure the epoxy per the schedule of the manufacturer.

Wire Bonding

RF bonds made with 3 mil \times 0.5 mil gold ribbon are recommended for the RF ports. These bonds must be thermosonically bonded with a force of 40 g to 60 g. Thermosonically bonded dc bonds of 0.025 mm diameter are recommended. Create ball bonds with a force of 40 g to 50 g, and wedge bonds with a force of 18 g to 22 g. Create all bonds with a nominal stage temperature of 150°C. Apply the minimum amount of ultrasonic energy (depending on the process and package being used) to achieve reliable bonds. Keep all bonds as short as possible, less than 0.31 mm.

Alternatively, short RF bonds that are ≤ 3 mm and made with two 1 mm wires can be used.

21924-063

21924-064

BIASING ADPA7007CHIP WITH THE HMC980LP4E

The [HMC980LP4E](#) is an active bias controller that is designed to meet the bias requirements for enhancement mode and depletion mode amplifiers such as the ADPA7007CHIP. The controller provides constant drain current biasing over temperature and part to part variation, and properly sequences gate and drain voltages to ensure the safe operation of the amplifier. The [HMC980LP4E](#) also offers self protection in the event of a short circuit, as well as an internal charge pump that generates the negative voltage needed on the gate of the ADPA7007CHIP, and the option to use an external negative voltage source. The [HMC980LP4E](#) is also available in die form as [HMC980-Die](#).

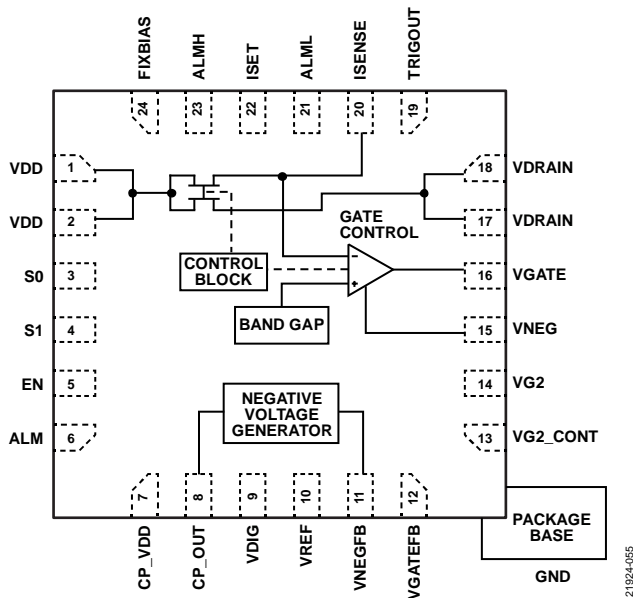

Figure 55. Functional Diagram of [HMC980LP4E](#)

APPLICATION CIRCUIT SETUP

Figure 56 displays the schematic of an application circuit using the [HMC980LP4E](#) to control the ADPA7007CHIP. When using an external negative supply for VNEG, refer to the schematic in Figure 57.

In the application circuit shown in Figure 56, the ADPA7007CHIP drain voltage and drain current are set by the following equations:

$$VDRAIN (5 V) = VDD (6.12 V) - IDRAIN (1600 mA) \times 0.7 \Omega \quad (1)$$

$$IDRAIN (1600 mA) = 150 \Omega \times A/R10 (93.1 \Omega) \quad (2)$$

LIMITING VGATE FOR ADPA7007CHIP V_{GGx} ABSOLUTE MAXIMUM RATING REQUIREMENT

When using the [HMC980LP4E](#) to control the ADPA7007CHIP, the minimum voltages for VNEG and VGATE must be $-1.5 V$ to keep the voltages within the absolute maximum rating limit for the V_{GGx} pad of the ADPA7007CHIP. To set the minimum voltages, set R15 and R16 to the values shown in Figure 56 and Figure 57. Refer to the [AN-1363](#) for more information and calculations for R15 and R16

The [HMC980LP4E](#) application circuits for biasing figures in the [AN-1363](#) are two examples of how the [HMC980LP4E](#) is used as an active bias controller. Both application circuits within the [AN-1363](#) show the R5 and R7 resistors, which are analogous to the R15 and R16 resistor shown in Figure 56 and Figure 57 within this data sheet.

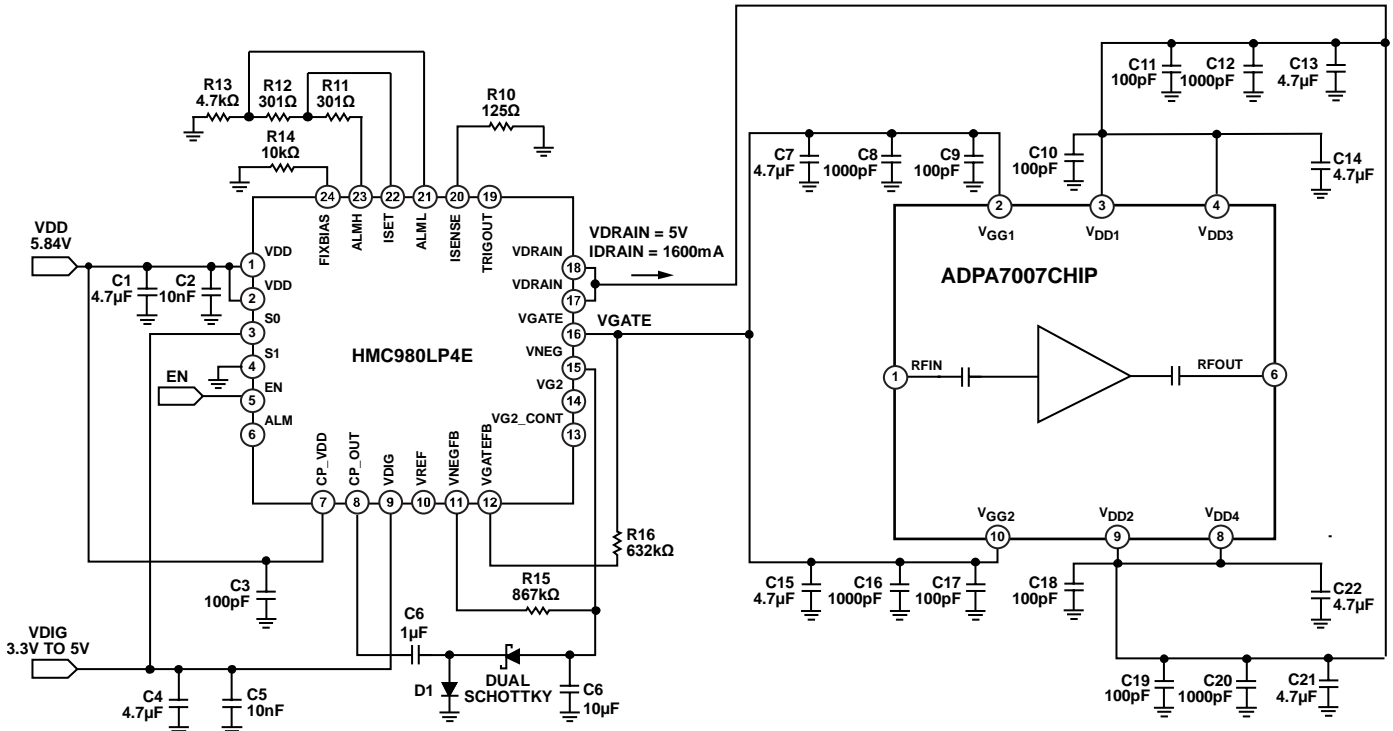

Figure 56. Application Circuit using HMC980LP4E with ADPA7007CHIP

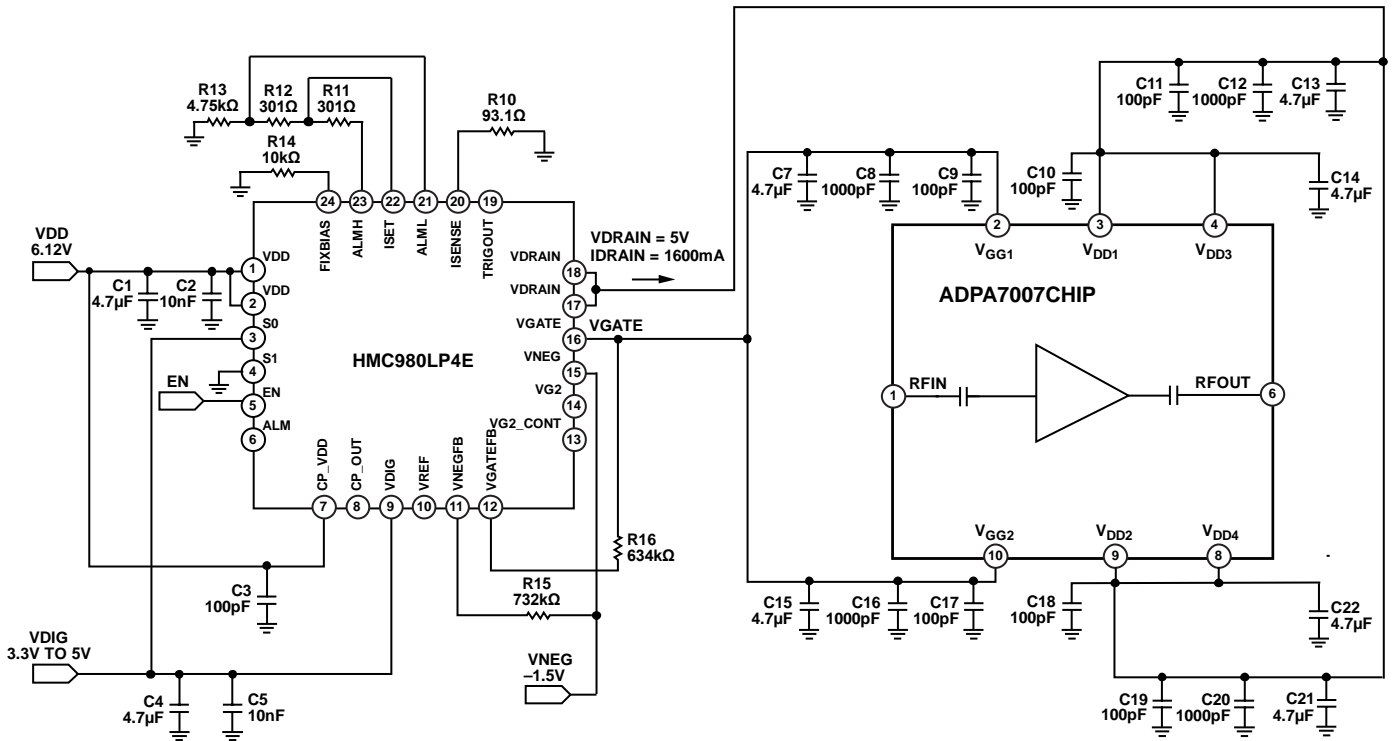

Figure 57. Application Circuit using HMC980LP4E with ADPA7007CHIP with External Negative Voltage Source

HMC980LP4E BIAS SEQUENCE

The dc supply sequencing that follows is required to prevent damage to the HMC980LP4E when using the device to control the ADPA7007CHIP.

Power-Up Sequence

The power-up sequence of the HMC980LP4E follows:

1. Set VDIG = 3.3 V
2. Set S0 = 3.3 V
3. Set V_{DD} = 5.68 V
4. Set VNEG = -1.5 V (unnecessary if using internally generated voltage)
5. Set EN = 3.3 V (the transition from 0 V to 3.3 V turns on VGATE and VDRAIN)

Power-Down Sequence

The power-down sequence of the HMC980LP4E follows:

1. Set EN = 0 V (the transition from 3.3 V to 0 V turns off VDRAIN and VGATE)
2. Set VNEG = 0 V (unnecessary if using internally generated voltage)
3. Set V_{DD} = 0 V
4. Set S0 = 0 V
5. Set VDIG = 0 V

After the HMC980LP4E bias control circuit is set up, toggle the bias to the ADPA7007CHIP on or off by applying 3.3 V or 0 V, respectively, to the EN pad. At EN = 3.3 V, VGATE drops to -1.5 V, and VDRAIN turns on at 5 V. VGATE then rises until IDRAIN = 1400 mA, and the closed control loop regulates IDRAIN at 1600 mA. When EN = 0 V, VGATE is set to -1.5 V, and VDRAIN is set to 0 V (see Figure 58 and Figure 59).

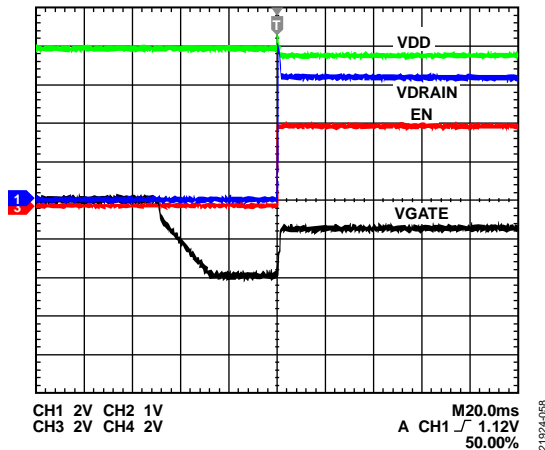

Figure 58. Turn On HMC980LP4E Outputs to ADPA7007CHIP

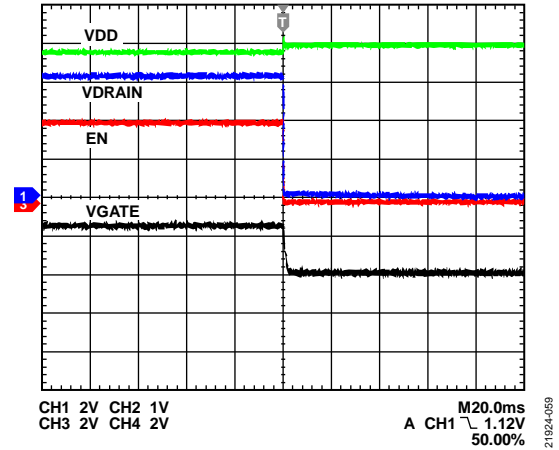

Figure 59. Turn Off HMC980LP4E Outputs to ADPA7007CHIP

CONSTANT DRAIN CURRENT BIASING vs. CONSTANT GATE VOLTAGE BIASING

The HMC980LP4E uses closed-loop feedback to continuously adjust VGATE to maintain a constant gate current bias over dc supply variation, temperature, and part to part variation. In addition, constant drain current bias is the optimum method for reducing time in calibration procedures and for maintaining consistent performance over time. By comparing constant gate current bias with a constant gate voltage bias where the current is driven to increase when RF power is applied, a slightly lower output P1dB is seen with a constant drain current bias. This output P1dB is shown in Figure 63, where the RF performance is slightly lower than the constant gate voltage bias operation due to a lower drain current at the high input powers as the device reaches 1 dB compression.

To increase the output P1dB performance for the constant drain current bias towards the constant gate voltage bias performance, increase the set current toward the I_{DD} this performance reaches under the RF drive in the constant gate voltage bias condition, as shown in Figure 63. The limit of increasing I_{DQ} under the constant drain current operation is set by the thermal limitations found in Table 4 from the amplifier data sheet with the maximum power dissipation specification. As I_{DD} increase continues, the actual output P1dB does not continue to increase indefinitely, and the power dissipation increases. Therefore, when using constant drain current biasing, note this exchange between the power dissipation and the output P1dB performance.

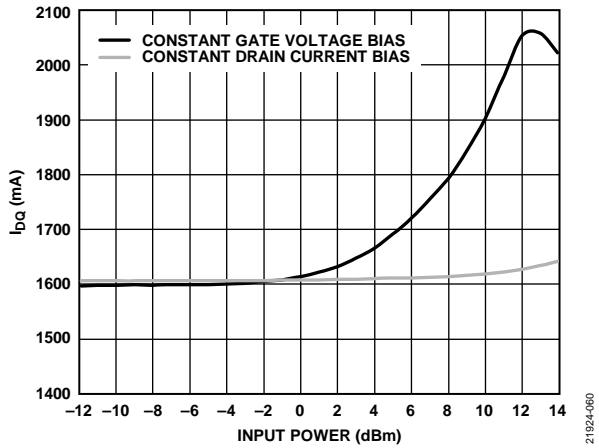

Figure 60. I_{DQ} vs. Input Power, $V_{DD} = 5\text{ V}$, Frequency = 32 GHz for Constant Gate Voltage Bias and Constant Drain Current Bias

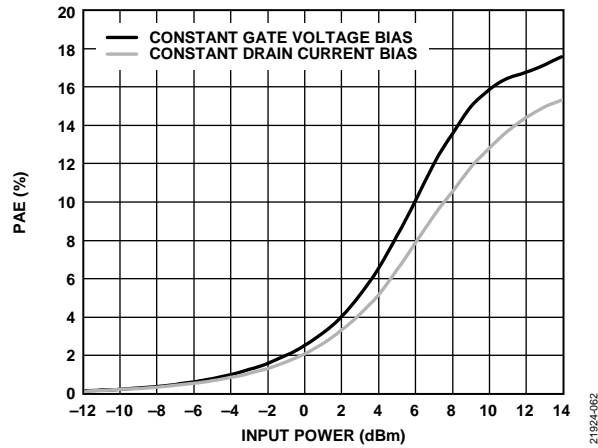

Figure 62. PAE vs. Input Power, $V_{DD} = 5\text{ V}$, Frequency = 32 GHz for Constant Gate Voltage Bias and Constant Drain Current Bias

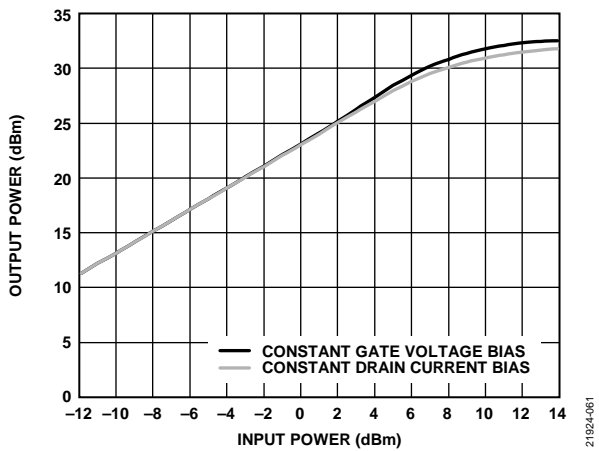

Figure 61. Output Power vs. Input Power, $V_{DD} = 5\text{ V}$, Frequency = 32 GHz for Constant Gate Voltage Bias and Constant Drain Current Bias

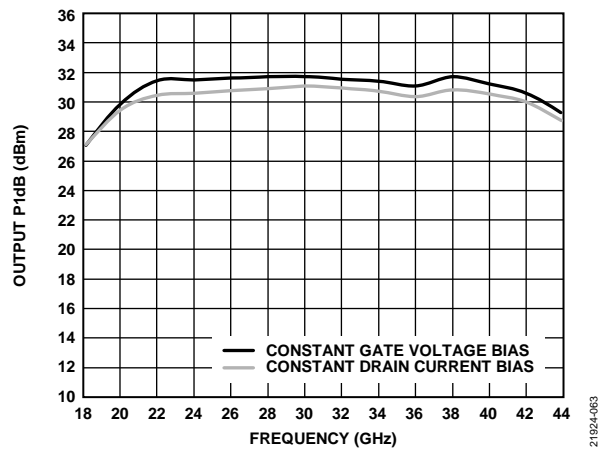

Figure 63. Output P1dB vs. Frequency, $V_{DD} = 5\text{ V}$, Frequency = 32 GHz for Constant Gate Voltage Bias and Constant Drain Current Bias

TYPICAL APPLICATION CIRCUIT

Figure 64 shows the typical application circuit.

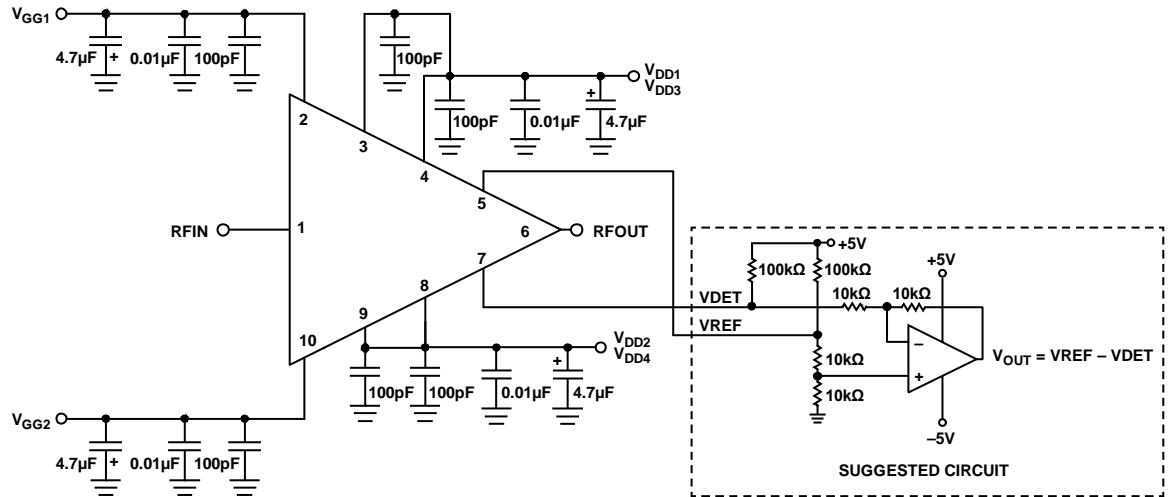

Figure 64. Typical Application Circuit (V_{OUT} Is the Output Voltage)

21924-064

ASSEMBLY DIAGRAM

Figure 65 shows the assembly diagram.

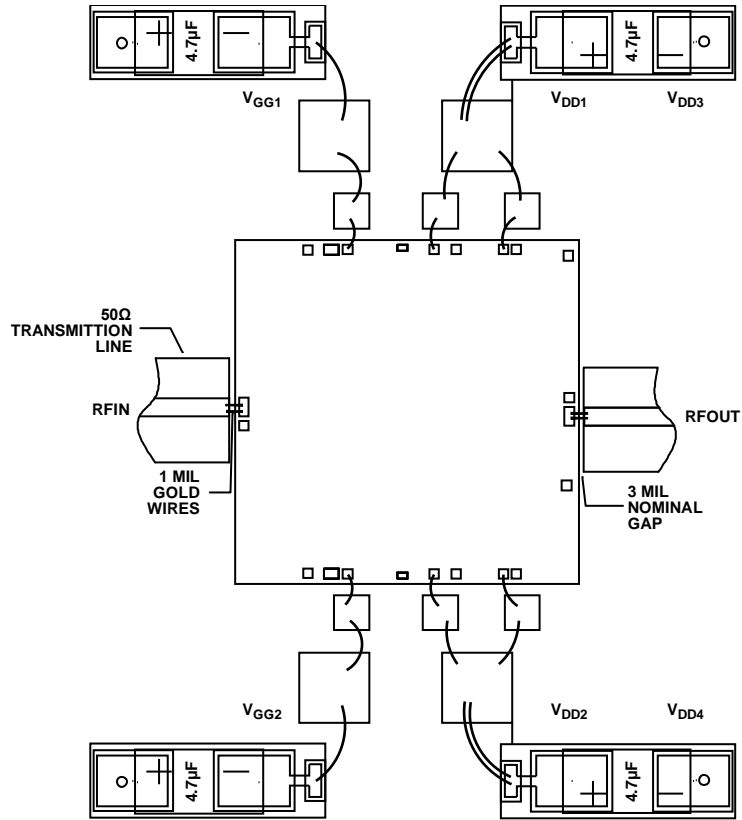
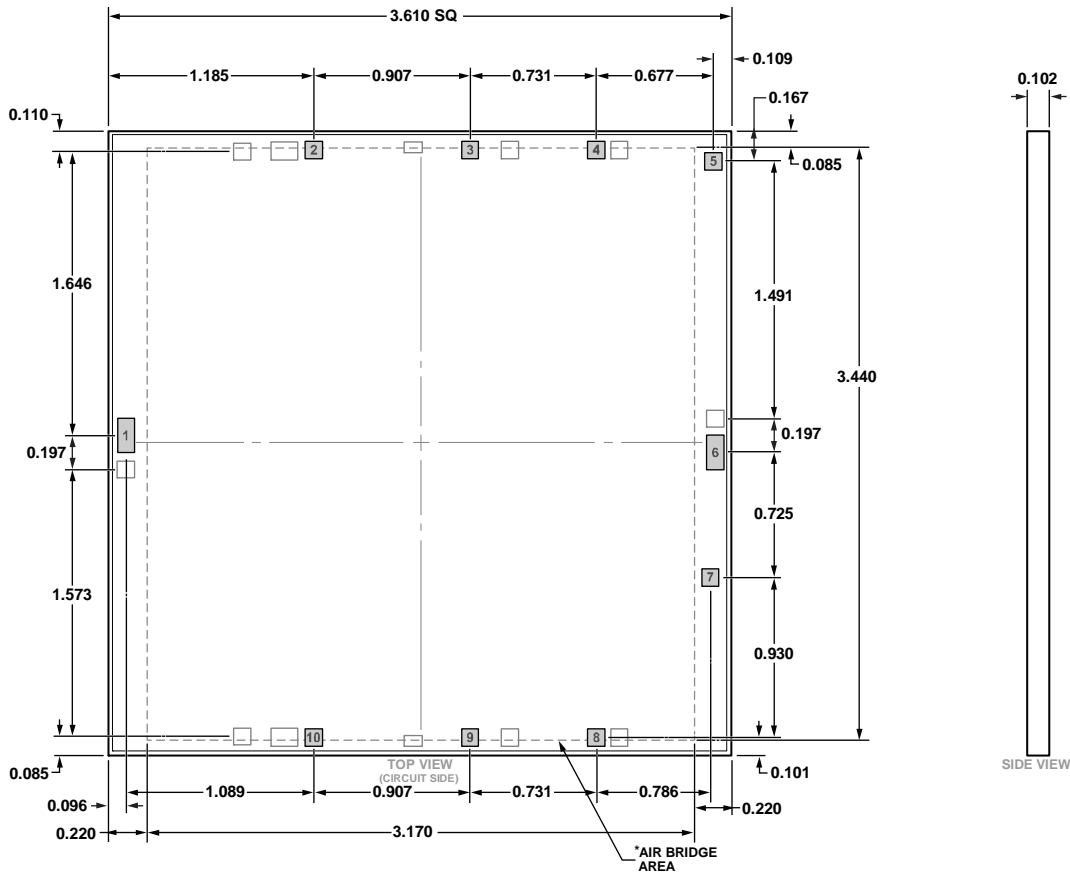

Figure 65. Assembly Diagram

21924-085

OUTLINE DIMENSIONS



*This die utilizes fragile air bridges. Any pickup tools used must not contact this area.

Figure 66. 10-Pad Bare Die [CHIP]
(C-10-11)
Dimensions shown in millimeters

03-06-2020-A

ORDERING GUIDE

Model ¹	Temperature Range	Package Description	Package Option
ADPA7007CHIP	-55°C to +85°C	10-Pad Bare Die [CHIP]	C-10-11
ADPA7007C-KIT	-55°C to +85°C	10-Pad Bare Die [CHIP]	C-10-11

¹ The ADPA7007CHIP and ADPA7007C-KIT are RoHS compliant parts.

Looking for pricing, stock, or lifecycle information?

Click below to explore more details on WIN SOURCE:

- ⊖ [View ADPA7007C-KIT on WIN SOURCE](#)
- ⊖ [Analog Devices Inc. Information](#)

Optimize Your Supply Chain with WIN SOURCE Solutions

- ✓ Global Sourcing Solution
- ✓ Obsolete Management
- ✓ Cost Control Management
- ✓ Shortage Management
- ✓ Alternative Solution
- ✓ Excess Inventory Management