



**THE DATASHEET OF  
ADPA7005-EVALZ**



18 GHz to 44 GHz, GaAs, pHEMT, 32 dBm (>1 W), MMIC Power Amplifier

**FEATURES**

- ▶ Output P1dB: up to 31 dBm typical
- ▶ P<sub>SAT</sub>: up to 32 dBm typical
- ▶ Gain: up to 15.5 dB typical
- ▶ Output IP3: up to 42.5 dBm typical
- ▶ Supply voltage: 5 V at 1400 mA
- ▶ 50 Ω matched input and output
- ▶ 18-terminal, 7 mm × 7 mm LCC\_HS package
- ▶ Integrated power detector

**APPLICATIONS**

- ▶ Military and space
- ▶ Test instrumentation
- ▶ Communications

**GENERAL DESCRIPTION**

The ADPA7005 is a gallium arsenide (GaAs), pseudomorphic high electron mobility transfer (pHEMT), monolithic microwave integrated circuit (MMIC), 32 dBm saturated output power (P<sub>SAT</sub>), >1 W, power amplifier, with an integrated temperature compensated, on-chip power detector that operates between 18 GHz and 44 GHz. The ADPA7005 provides 15.5 dB of small signal gain and approximately 32 dBm of P<sub>SAT</sub> at 32 GHz from a 5 V supply (see Figure 26). The ADPA7005 has an output IP3 of 40 dBm between 24 GHz to 34 GHz and is ideal for linear applications such as electronic countermeasure and instrumentation applications requiring >30 dBm of efficient P<sub>SAT</sub>. The RF input and outputs are internally matched and dc blocked for ease of integration into higher level assemblies. The ADPA7005 is packaged in a 7 mm × 7 mm, 18-terminal ceramic leadless chip carrier with heat sink (LCC\_HS) that exhibits low thermal resistance and is compatible with surface-mount manufacturing techniques.

**FUNCTIONAL BLOCK DIAGRAM**

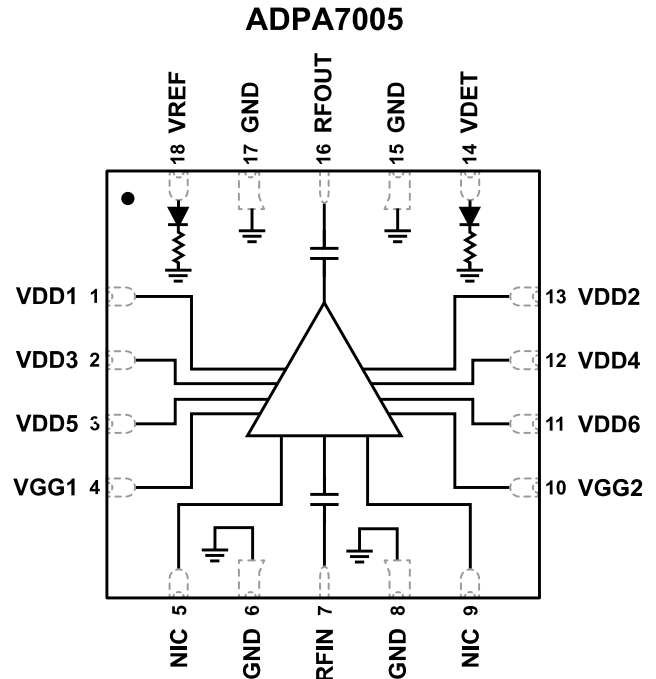

Figure 1.

001

**TABLE OF CONTENTS**

Features.....	1	Typical Performance Characteristics.....	8
Applications.....	1	Constant $I_{DD}$ Operation.....	15
General Description.....	1	Theory of Operation.....	16
Functional Block Diagram.....	1	Applications Information.....	17
Specifications.....	3	Biasing ADPA7005 with the HMC980LP4E.....	19
18 GHz to 20 GHz Frequency Range.....	3	Application Circuit Setup.....	19
20 GHz to 24 GHz Frequency Range.....	3	Limiting VGATE and VNEG for ADPA7005	
24 GHz to 34 GHz Frequency Range.....	4	$V_{GGx}$ Absolute Maximum Rating	
34 GHz to 44 GHz Frequency Range .....	4	Requirement.....	19
Absolute Maximum Ratings.....	5	HMC980LP4E Bias Sequence.....	22
Thermal Resistance.....	5	Constant Drain Current Biasing vs.	
Electrostatic Discharge (ESD) Ratings.....	5	Constant Gate Voltage Biasing.....	23
ESD Caution.....	5	Outline Dimensions.....	24
Pin Configuration and Function Descriptions.....	6	Ordering Guide.....	24
Interface Schematics .....	7	Evaluation Boards.....	24

**REVISION HISTORY**

**1/2022—Revision A: Initial Version**

## SPECIFICATIONS

## 18 GHz TO 20 GHz FREQUENCY RANGE

$T_{CASE} = 25^{\circ}\text{C}$ , drain bias voltage ( $V_{DD}$ ) = 5 V, and quiescent drain current ( $I_{DQ}$ ) = 1400 mA for nominal operation, unless otherwise noted. 50  $\Omega$  matched input and output.

Table 1.

Parameter	Symbol	Min	Typ	Max	Unit	Test Conditions/Comments
FREQUENCY RANGE		18		20	GHz	
GAIN			14.5		dB	
Gain Flatness			$\pm 1$		dB	
Gain Variation over Temperature			0.021		dB/ $^{\circ}\text{C}$	
NOISE FIGURE			11		dB	
RETURN LOSS						
Input			18		dB	
Output			12.5		dB	
OUTPUT						
Output Power for 1 dB Compression	P1dB		29		dBm	
Saturated Output Power	$P_{SAT}$		30		dBm	
Output Third-Order Intercept	IP3		37.5		dBm	Measurement taken at output power ( $P_{OUT}$ ) per tone = 16 dBm
POWER ADDED EFFICIENCY	PAE		11		%	Measured at $P_{SAT}$
SUPPLY						Adjust gate bias voltage ( $V_{GGx}$ ) from -1.5 V up to 0 V to achieve the desired $I_{DQ}$ , $V_{GGx} = -0.685$ V typical to achieve $I_{DQ} = 1400$ mA
Quiescent Drain Current	$I_{DQ}$		1400		mA	
Drain Bias Voltage	$V_{DD}$	4	5		V	

## 20 GHz TO 24 GHz FREQUENCY RANGE

$T_{CASE} = 25^{\circ}\text{C}$ ,  $V_{DD} = 5$  V, and  $I_{DQ} = 1400$  mA for nominal operation, unless otherwise noted. 50  $\Omega$  matched input and output.

Table 2.

Parameter	Symbol	Min	Typ	Max	Unit	Test Conditions/Comments
FREQUENCY RANGE		20		24	GHz	
GAIN		13	15.5		dB	
Gain Flatness			$\pm 0.5$		dB	
Gain Variation over Temperature			0.018		dB/ $^{\circ}\text{C}$	
NOISE FIGURE			8		dB	
RETURN LOSS						
Input			12		dB	
Output			12.5		dB	
OUTPUT						
Output Power for 1 dB Compression	P1dB	27.5	30		dBm	
Saturated Output Power	$P_{SAT}$		30.5		dBm	
Output Third-Order Intercept	IP3		39		dBm	Measurement taken at $P_{OUT}$ per tone = 16 dBm
POWER ADDED EFFICIENCY	PAE		13		%	Measured at $P_{SAT}$
SUPPLY						Adjust $V_{GGx}$ from -1.5 V up to 0 V to achieve the desired $I_{DQ}$ , $V_{GGx} = -0.685$ V typical to achieve $I_{DQ} = 1400$ mA
Quiescent Drain Current	$I_{DQ}$		1400		mA	
Drain Bias Voltage	$V_{DD}$	4	5		V	

## SPECIFICATIONS

## 24 GHZ TO 34 GHZ FREQUENCY RANGE

$T_{CASE} = 25^{\circ}C$ ,  $V_{DD} = 5 V$ , and  $I_{DQ} = 1400 mA$  for nominal operation, unless otherwise noted. 50  $\Omega$  matched input and output.

Table 3.

Parameter	Symbol	Min	Typ	Max	Unit	Test Conditions/Comments
FREQUENCY RANGE		24		34	GHz	
GAIN		13.5	15.5		dB	
Gain Flatness			$\pm 0.5$		dB	
Gain Variation over Temperature			0.015		dB/ $^{\circ}C$	
NOISE FIGURE			7		dB	
RETURN LOSS						
Input			10		dB	
Output			12		dB	
OUTPUT						
Output Power for 1 dB Compression	P1dB	28.5	31		dBm	
Saturated Output Power	$P_{SAT}$		32		dBm	
Output Third-Order Intercept	IP3		40		dBm	Measurement taken at $P_{OUT}$ per tone = 16 dBm
POWER ADDED EFFICIENCY	PAE		13		%	Measured at $P_{SAT}$
SUPPLY						Adjust $V_{GGx}$ from $-1.5 V$ up to $0 V$ to achieve the desired $I_{DQ}$ , $V_{GGx} = -0.685 V$ typical to achieve $I_{DQ} = 1400 mA$
Quiescent Drain Current	$I_{DQ}$		1400		mA	
Drain Bias Voltage	$V_{DD}$	4	5		V	

## 34 GHZ TO 44 GHZ FREQUENCY RANGE

$T_{CASE} = 25^{\circ}C$ ,  $V_{DD} = 5 V$ , and  $I_{DQ} = 1400 mA$  for nominal operation, unless otherwise noted. 50  $\Omega$  matched input and output.

Table 4.

Parameter	Symbol	Min	Typ	Max	Unit	Test Conditions/Comments
FREQUENCY RANGE		34		44	GHz	
GAIN		11	14.5		dB	
Gain Flatness			$\pm 1$		dB	
Gain Variation over Temperature			0.021		dB/ $^{\circ}C$	
NOISE FIGURE			6		dB	
RETURN LOSS						
Input			10		dB	
Output			14		dB	
OUTPUT						
Output Power for 1 dB Compression	P1dB	28.5	30.5		dBm	
Saturated Output Power	$P_{SAT}$		31		dBm	
Output Third-Order Intercept	IP3		42.5		dBm	Measurement taken at $P_{OUT}$ per tone = 16 dBm
POWER ADDED EFFICIENCY	PAE		8		%	Measured at $P_{SAT}$
SUPPLY						Adjust $V_{GGx}$ from $-1.5 V$ up to $0 V$ to achieve the desired $I_{DQ}$ , $V_{GGx} = -0.685 V$ typical to achieve $I_{DQ} = 1400 mA$
Quiescent Drain Current	$I_{DQ}$		1400		mA	
Drain Bias Voltage	$V_{DD}$	4	5		V	

## ABSOLUTE MAXIMUM RATINGS

Table 5.

Parameter	Rating
Drain Bias Voltage (VDDx)	6.0 V
Gate Bias Voltage (VGGx)	-1.6 to 0 V
RF Input Power (RFIN)	27 dBm
Continuous Power Dissipation ( $P_{DISS}$ ), $T_{CASE} = 85^{\circ}\text{C}$ (Derate 137 mW/ $^{\circ}\text{C}$ Above $85^{\circ}\text{C}$ )	12.33 W
Temperature	
Storage Range	-55 $^{\circ}\text{C}$ to +150 $^{\circ}\text{C}$
Operating Range	-40 $^{\circ}\text{C}$ to +85 $^{\circ}\text{C}$
Maximum Channel	175 $^{\circ}\text{C}$
Quiescent Channel ( $T_{CASE} = 85^{\circ}\text{C}$ , $V_{DD} = 5\text{ V}$ , $I_{DQ} = 1400\text{ mA}$ , Input Power ( $P_{IN}$ ) = Off)	136.1 $^{\circ}\text{C}$

Stresses at or above those listed under Absolute Maximum Ratings may cause permanent damage to the product. This is a stress rating only; functional operation of the product at these or any other conditions above those indicated in the operational section of this specification is not implied. Operation beyond the maximum operating conditions for extended periods may affect product reliability.

## THERMAL RESISTANCE

Thermal performance is directly linked to system design and operating environment. Careful attention to the printed circuit board (PCB) thermal design is required.

$\theta_{JC}$  is the channel to case thermal resistance (channel to exposed metal paddle/pad on the underside of the device).

Table 6. Thermal Resistance

Package Type	$\theta_{JC}$	Unit
EH-18-1 <sup>1</sup>	7.3	$^{\circ}\text{C}/\text{W}$

<sup>1</sup>  $\theta_{JC}$  is determined by simulation under the following conditions: the heat transfer is due solely to thermal conduction from the channel, through the ground pad, to the PCB. The ground pad is held constant at the operating temperature of 85 $^{\circ}\text{C}$ .

## ELECTROSTATIC DISCHARGE (ESD) RATINGS

The following ESD information is provided for handling of ESD-sensitive devices in an ESD protected area only.

Human body model (HBM) per ANSI/ESDA/JEDEC JS-001.

### ESD Ratings for ADPA7005

Table 7. ADPA7005, 18-Terminal LCC\_HS

ESD Model	Withstand Threshold (V)	Class
HBM	250	1A

## ESD CAUTION



**ESD (electrostatic discharge) sensitive device.** Charged devices and circuit boards can discharge without detection. Although this product features patented or proprietary protection circuitry, damage may occur on devices subjected to high energy ESD. Therefore, proper ESD precautions should be taken to avoid performance degradation or loss of functionality.

PIN CONFIGURATION AND FUNCTION DESCRIPTIONS

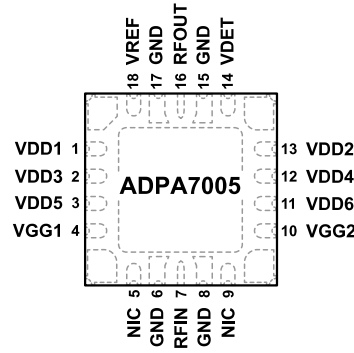

- NOTES  
 1. NIC = NO INTERNAL CONNECTION. NOTE THAT DATA SHOWN HEREIN WAS MEASURED WITH THESE PINS EXTERNALLY CONNECTED TO RF AND DC GROUND.  
 2. EXPOSED PAD. THE EXPOSED PAD MUST BE CONNECTED TO RF AND DC GROUND.

002

Figure 2. Pin Configuration

Table 8. Pin Function Descriptions

Pin No.	Mnemonic	Description
1, 2, 3, 11, 12, 13	VDD1, VDD3, VDD5, VDD6, VDD4, VDD2	Drain Bias for the Amplifier.
4, 10	VGG1, VGG2	Amplifier Gate Control. ESD protection diodes are included and turn on below -1.5 V.
5, 9	NIC	Not Internally Connected. Note that data shown herein was measured with the NIC pins externally connected to RF and dc ground.
6, 8, 15, 17	GND	Ground Pins. Connect the GND pins and the exposed pad to RF and dc ground.
7	RFIN	RF Signal Input. The RFIN pin is ac-coupled and internally matched to 50 Ω.
14	VDET	Detector Diode Used for Measuring the RF Output Power. Detection via the VDET pin requires the application of a dc bias voltage through an external series resistor. Used in combination with VREF, the difference voltage, VREF - VDET, is a temperature compensated dc voltage proportional to the RF output power.
16	RFOUT	RF Signal Output. The RFOUT pin is ac-coupled and internally matched to 50 Ω.
18	VREF	Reference Diode Used for Temperature Compensation of VDET RF Output Power Measurements. Detection via the VREF pin requires the application of a dc bias voltage through an external series resistor. Used in combination with VDET, this voltage provides temperature compensation to VDET RF output power measurements.
	EPAD	Exposed Pad. The exposed pad must be connected to RF and dc ground.

INTERFACE SCHEMATICS



Figure 3. GND Interface Schematic

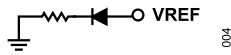

Figure 4. VREF Interface Schematic

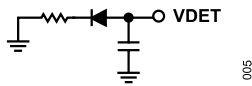

Figure 5. VDET Interface Schematic

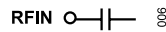

Figure 6. RFIN Interface Schematic

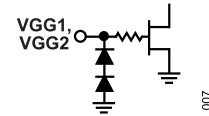

Figure 7. VGG1, VGG2 Interface Schematic



Figure 8. RFOUT Interface Schematic

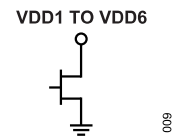

Figure 9. VDD1 to VDD6 Interface Schematic

TYPICAL PERFORMANCE CHARACTERISTICS

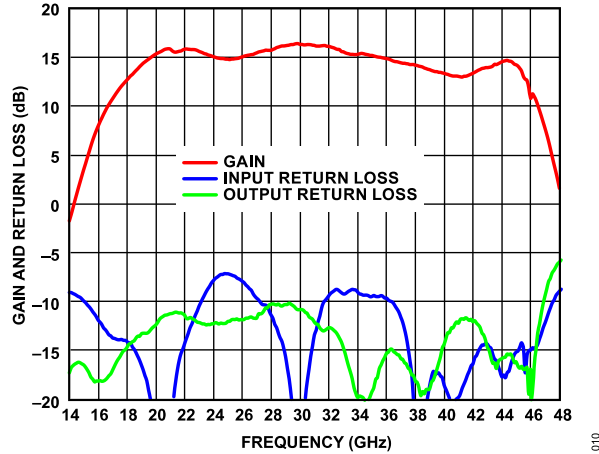

Figure 10. Gain and Return Loss vs. Frequency,  $V_{DD} = 5\text{ V}$ ,  $I_{DQ} = 1400\text{ mA}$

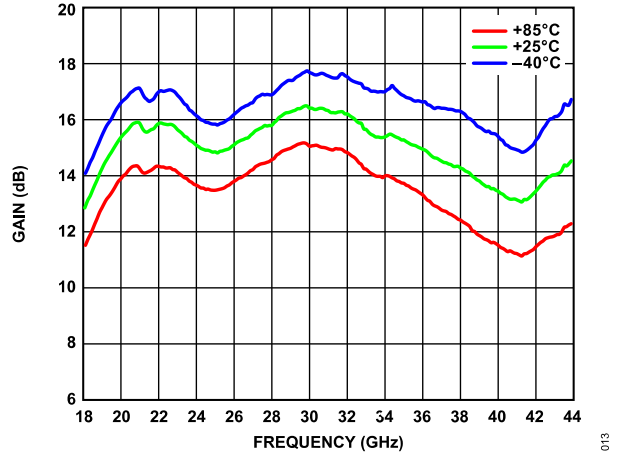

Figure 13. Gain vs. Frequency for Various Temperatures,  $V_{DD} = 5\text{ V}$ ,  $I_{DQ} = 1400\text{ mA}$

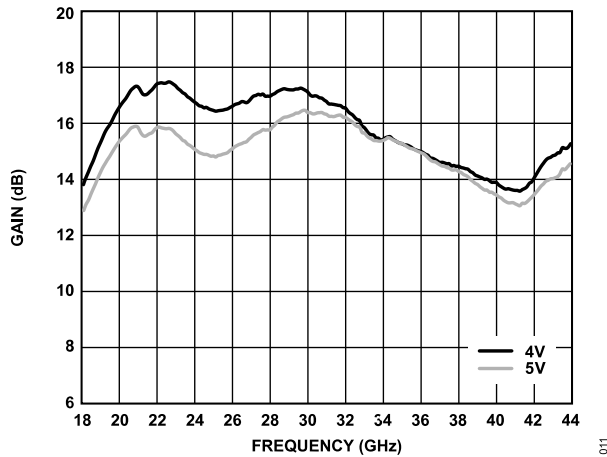

Figure 11. Gain vs. Frequency for Various  $V_{DD}$ ,  $I_{DQ} = 1400\text{ mA}$

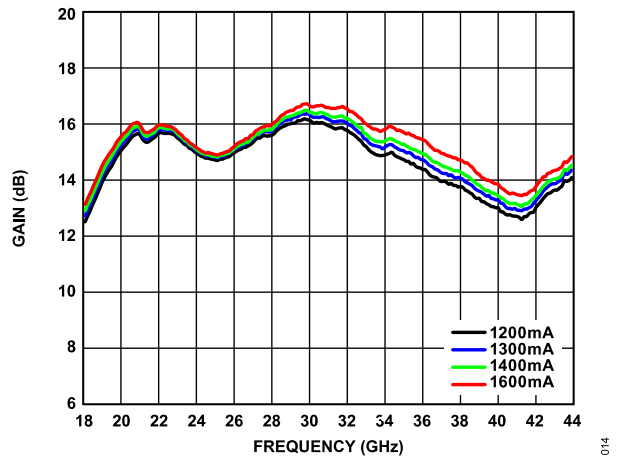

Figure 14. Gain vs. Frequency for Various  $I_{DQ}$ ,  $V_{DD} = 5\text{ V}$

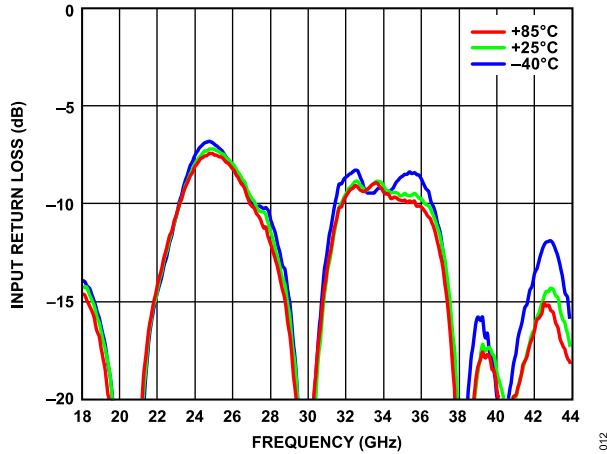

Figure 12. Input Return Loss vs. Frequency for Various Temperatures,  $V_{DD} = 5\text{ V}$ ,  $I_{DQ} = 1400\text{ mA}$

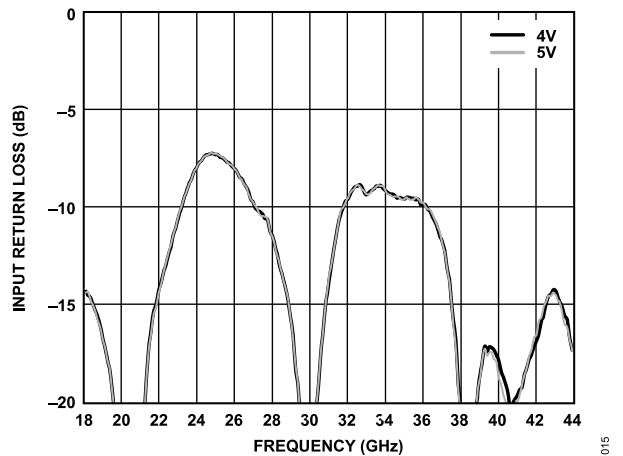

Figure 15. Input Return Loss vs. Frequency for Various  $V_{DD}$ ,  $I_{DQ} = 1400\text{ mA}$

TYPICAL PERFORMANCE CHARACTERISTICS

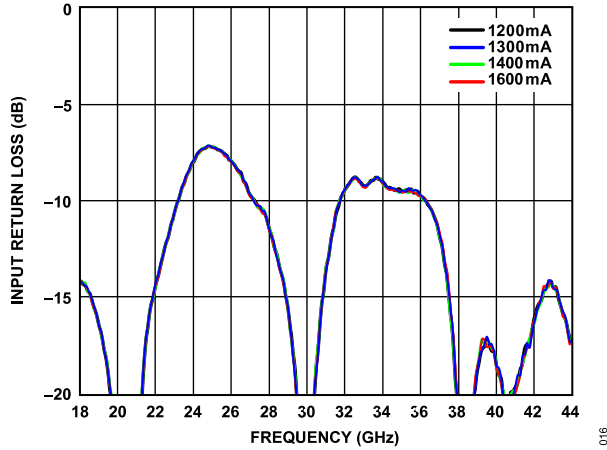

Figure 16. Input Return Loss vs. Frequency for Various  $I_{DQ}$ ,  $V_{DD} = 5\text{ V}$

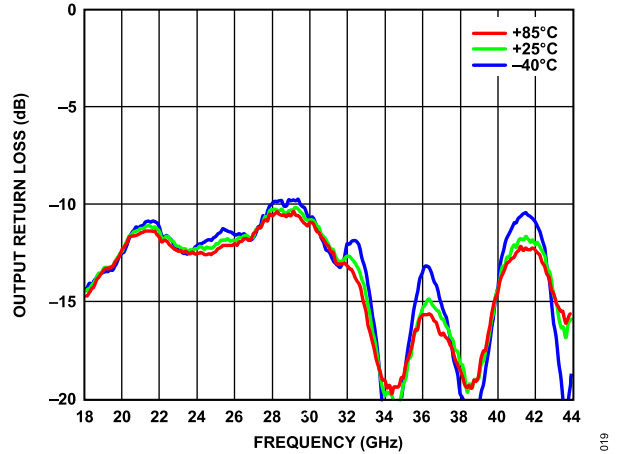

Figure 19. Output Return Loss vs. Frequency for Various Temperatures,  $V_{DD} = 5\text{ V}$ ,  $I_{DQ} = 1400\text{ mA}$

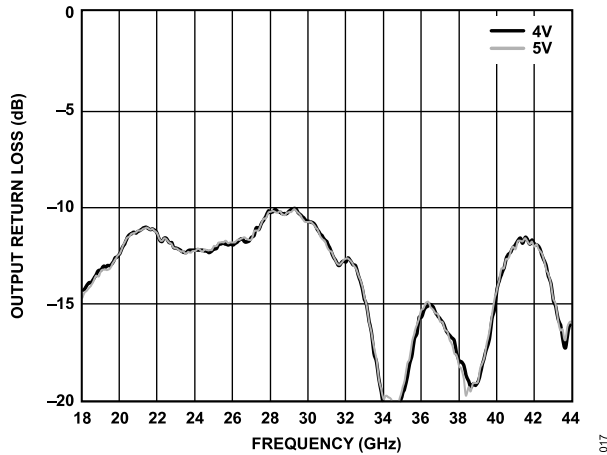

Figure 17. Output Return Loss vs. Frequency for Various  $V_{DD}$ ,  $I_{DQ} = 1400\text{ mA}$

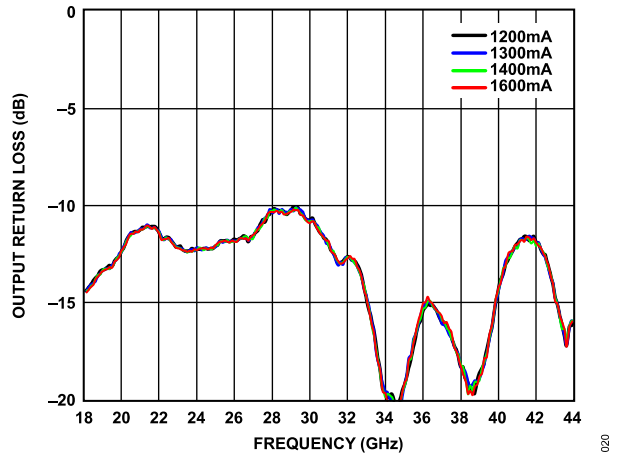

Figure 20. Output Return Loss vs. Frequency for Various  $I_{DQ}$ ,  $V_{DD} = 5\text{ V}$

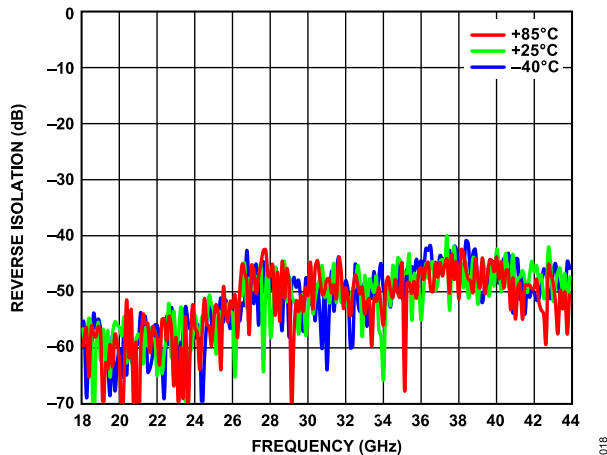

Figure 18. Reverse Isolation vs. Frequency for Various Temperatures,  $V_{DD} = 5\text{ V}$ ,  $I_{DQ} = 1400\text{ mA}$

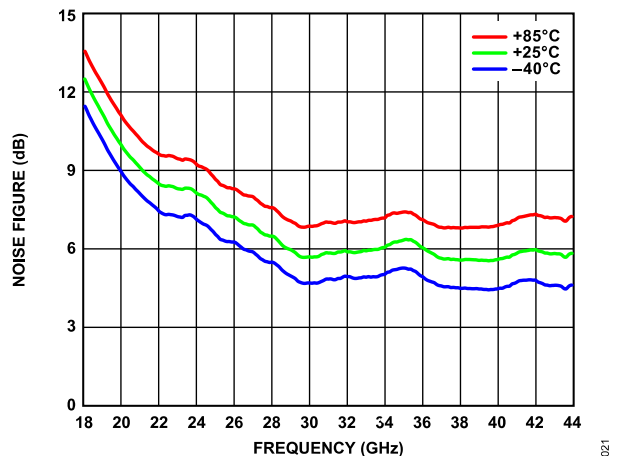

Figure 21. Noise Figure vs. Frequency for Various Temperatures,  $V_{DD} = 5\text{ V}$ ,  $I_{DQ} = 1400\text{ mA}$

TYPICAL PERFORMANCE CHARACTERISTICS

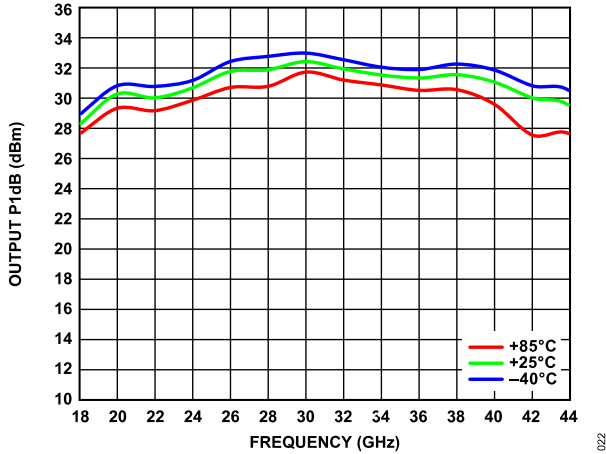

Figure 22. Output P1dB vs. Frequency for Various Temperatures,  $V_{DD} = 5\text{ V}$ ,  $I_{DQ} = 1400\text{ mA}$

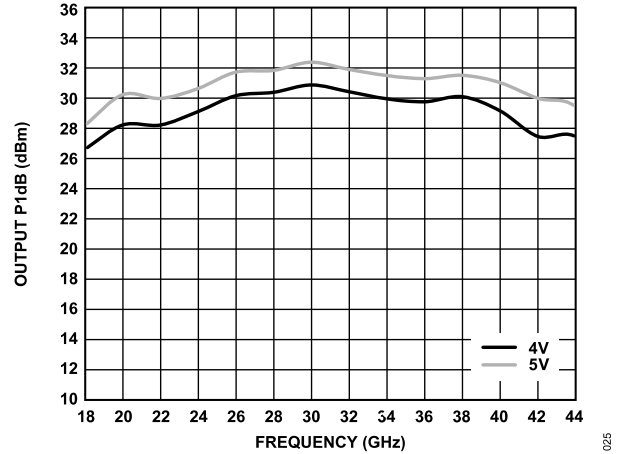

Figure 25. Output P1dB vs. Frequency for Various  $V_{DD}$ ,  $I_{DQ} = 1400\text{ mA}$

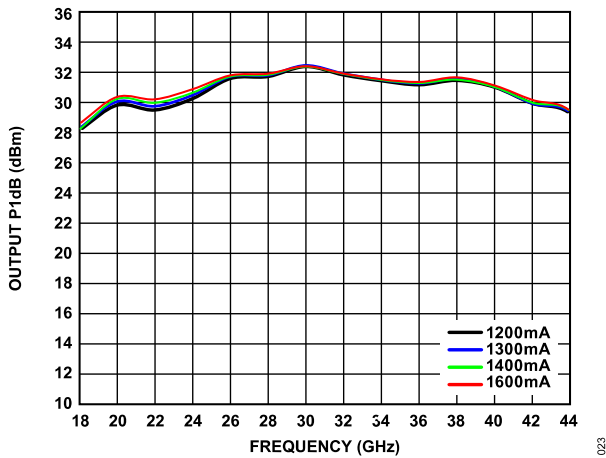

Figure 23. Output P1dB vs. Frequency for Various  $I_{DQ}$ ,  $V_{DD} = 5\text{ V}$

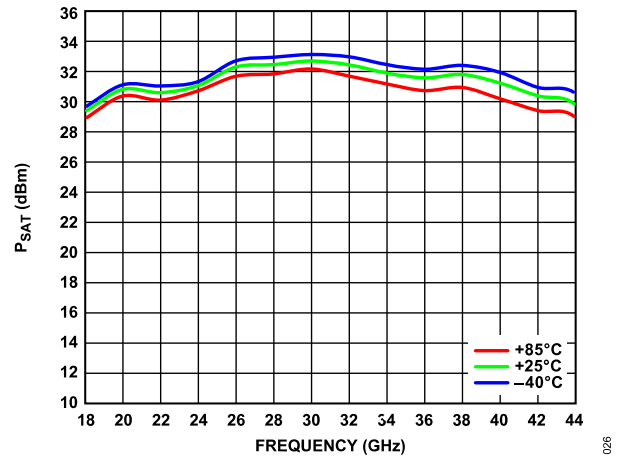

Figure 26.  $P_{SAT}$  vs. Frequency for Various Temperatures,  $V_{DD} = 5\text{ V}$ ,  $I_{DQ} = 1400\text{ mA}$

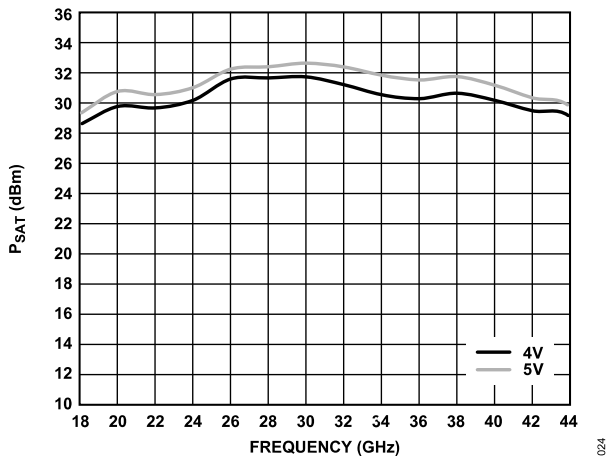

Figure 24.  $P_{SAT}$  vs. Frequency for Various  $V_{DD}$ ,  $I_{DQ} = 1400\text{ mA}$

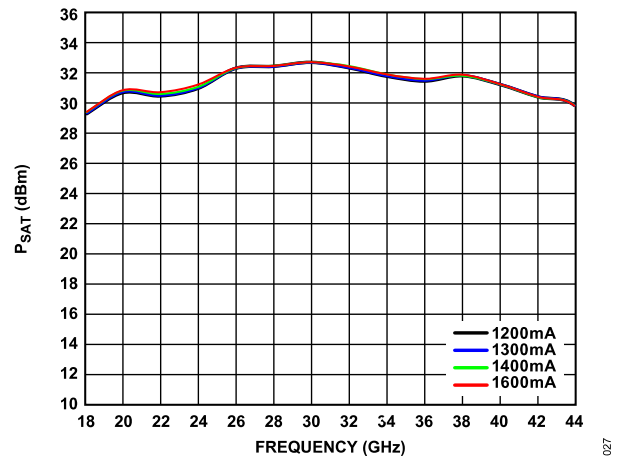

Figure 27.  $P_{SAT}$  vs. Frequency for Various  $I_{DQ}$ ,  $V_{DD} = 5\text{ V}$

TYPICAL PERFORMANCE CHARACTERISTICS

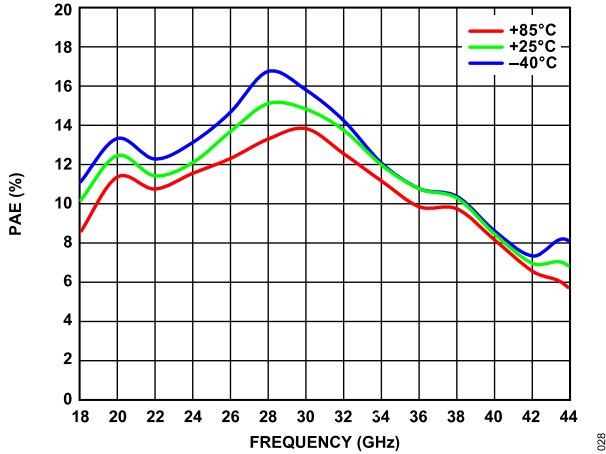

Figure 28. Power Added Efficiency (PAE) vs. Frequency for Various Temperatures,  $V_{DD} = 5\text{ V}$ ,  $I_{DQ} = 1400\text{ mA}$ , PAE Measured at  $P_{SAT}$

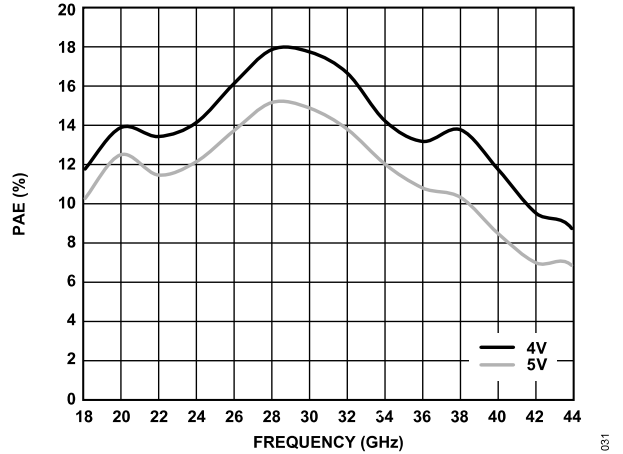

Figure 31. PAE vs. Frequency for Various  $V_{DD}$ ,  $I_{DQ} = 1400\text{ mA}$ , PAE Measured at  $P_{SAT}$

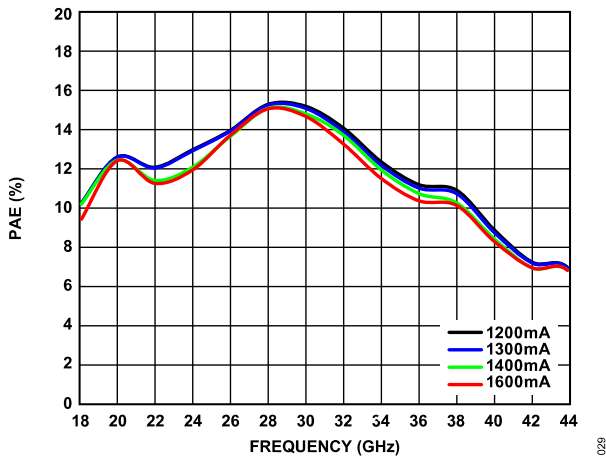

Figure 29. PAE vs. Frequency for Various  $I_{DQ}$ ,  $V_{DD} = 5\text{ V}$ ,  $I_{DQ} = 1400\text{ mA}$ , PAE Measured at  $P_{SAT}$

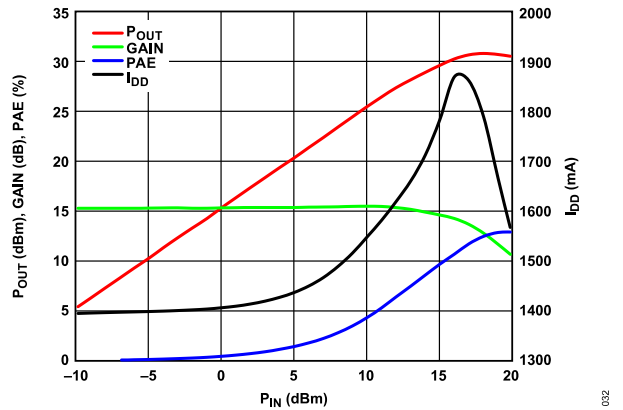

Figure 32.  $P_{OUT}$ , Gain, PAE, and  $I_{DD}$  vs.  $P_{IN}$ , 20 GHz,  $V_{DD} = 5\text{ V}$ ,  $I_{DQ} = 1400\text{ mA}$

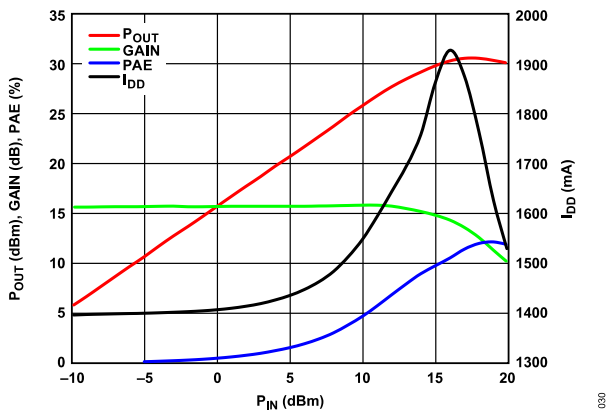

Figure 30.  $P_{OUT}$ , Gain, PAE, and Drain Current with RF Applied ( $I_{DD}$ ) vs.  $P_{IN}$ , 22 GHz,  $V_{DD} = 5\text{ V}$ ,  $I_{DQ} = 1400\text{ mA}$

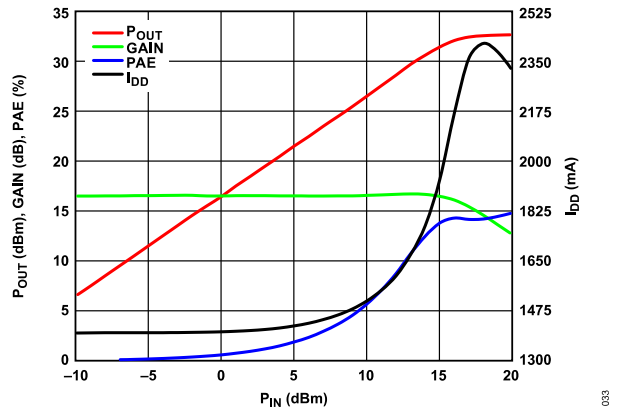

Figure 33.  $P_{OUT}$ , Gain, PAE, and  $I_{DD}$  vs.  $P_{IN}$ , 30 GHz,  $V_{DD} = 5\text{ V}$ ,  $I_{DQ} = 1400\text{ mA}$

TYPICAL PERFORMANCE CHARACTERISTICS

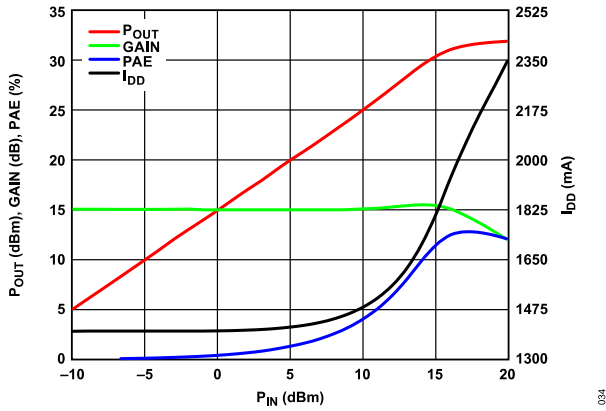

Figure 34.  $P_{OUT}$ , Gain, PAE, and  $I_{DD}$  vs.  $P_{IN}$ , 34 GHz,  $V_{DD} = 5 V$ ,  $I_{DQ} = 1400 mA$

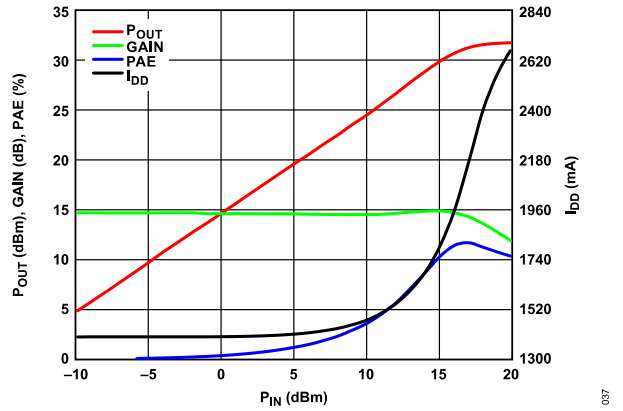

Figure 37.  $P_{OUT}$ , Gain, PAE, and  $I_{DD}$  vs.  $P_{IN}$ , 38 GHz,  $V_{DD} = 5 V$ ,  $I_{DQ} = 1400 mA$

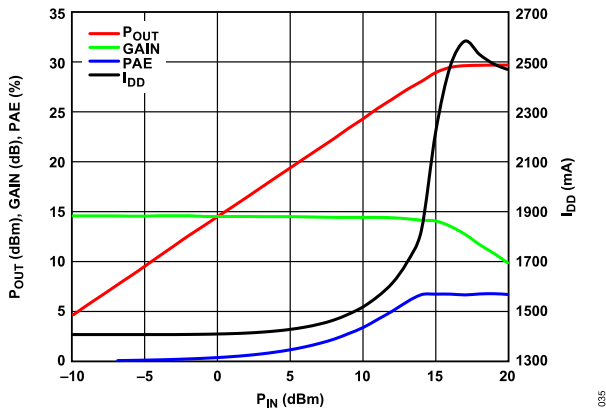

Figure 35.  $P_{OUT}$ , Gain, PAE, and  $I_{DD}$  vs.  $P_{IN}$ , 44 GHz,  $V_{DD} = 5 V$ ,  $I_{DQ} = 1400 mA$

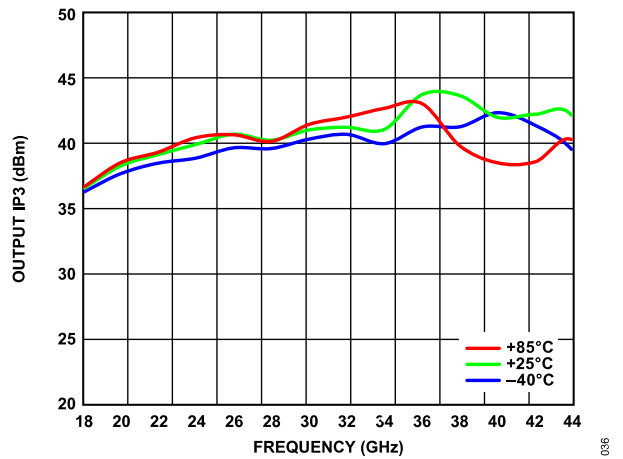

Figure 38. Output IP3 vs. Frequency for Various Temperatures,  $P_{OUT}$  per Tone = 16 dBm,  $V_{DD} = 5 V$ ,  $I_{DQ} = 1400 mA$

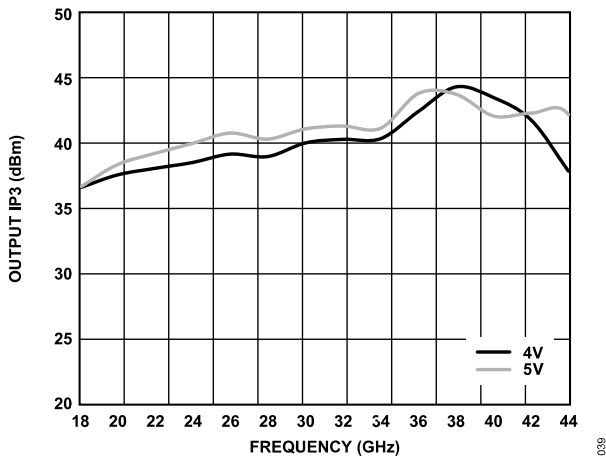

Figure 36. Output IP3 vs. Frequency for Various  $V_{DD}$ ,  $P_{OUT}$  per Tone = 16 dBm,  $V_{DD} = 5 V$ ,  $I_{DQ} = 1400 mA$

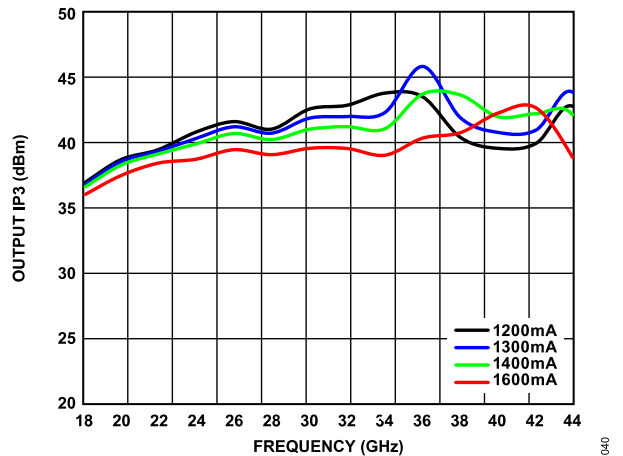

Figure 39. Output IP3 vs. Frequency for Various  $I_{DQ}$ ,  $P_{OUT}$  per Tone = 16 dBm,  $V_{DD} = 5 V$

TYPICAL PERFORMANCE CHARACTERISTICS

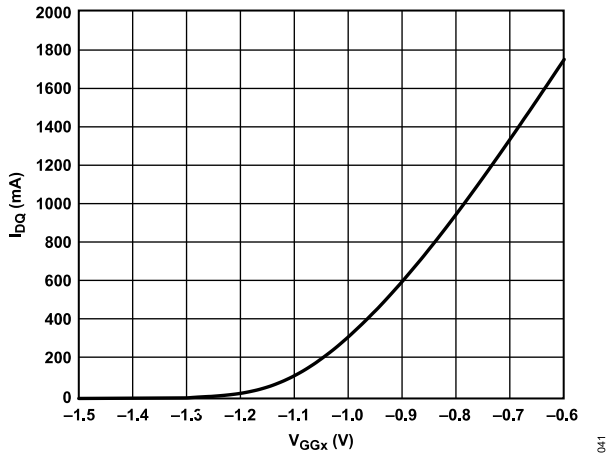

Figure 40.  $I_{DQ}$  vs.  $V_{GGx}$

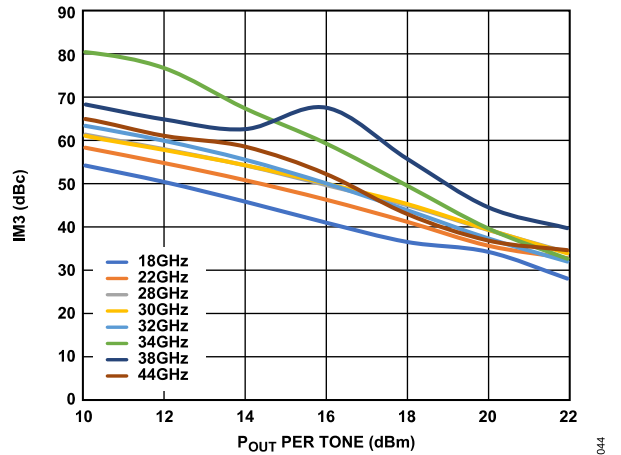

Figure 43. Third-Order Intermodulation Distortion (IM3) vs.  $P_{OUT}$  per Tone,  $V_{DD} = 5\text{ V}$ ,  $I_{DQ} = 1400\text{ mA}$

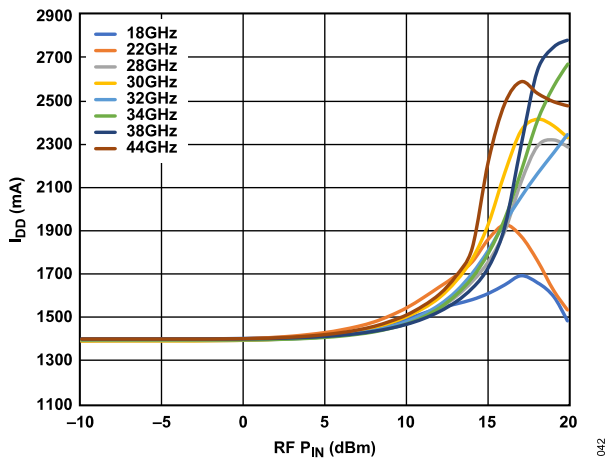

Figure 41.  $I_{DD}$  vs.  $RF\ P_{IN}$  at Various Frequencies,  $V_{DD} = 5\text{ V}$ ,  $I_{DQ} = 1400\text{ mA}$

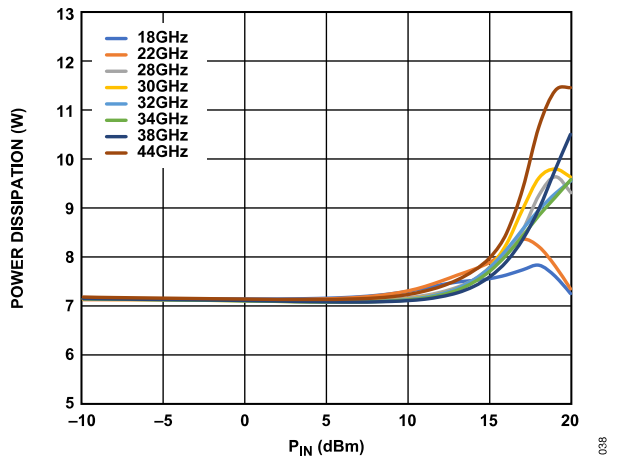

Figure 44. Power Dissipation vs.  $P_{IN}$  at  $T_{CASE} = 85^\circ\text{C}$ ,  $V_{DD} = 5\text{ V}$ ,  $I_{DQ} = 1400\text{ mA}$

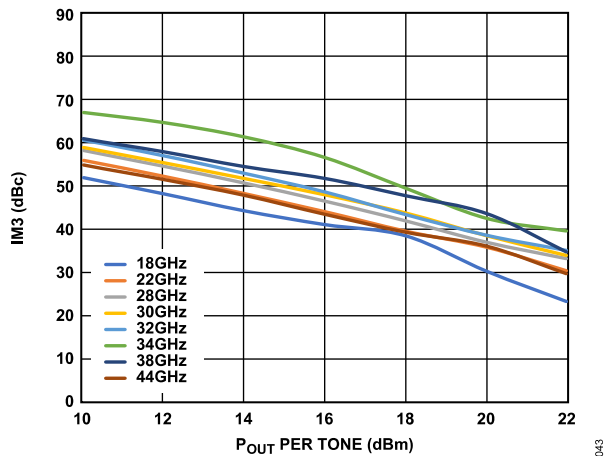

Figure 42. Third-Order Intermodulation Distortion (IM3) vs.  $P_{OUT}$  per Tone,  $V_{DD} = 4\text{ V}$ ,  $I_{DQ} = 1400\text{ mA}$

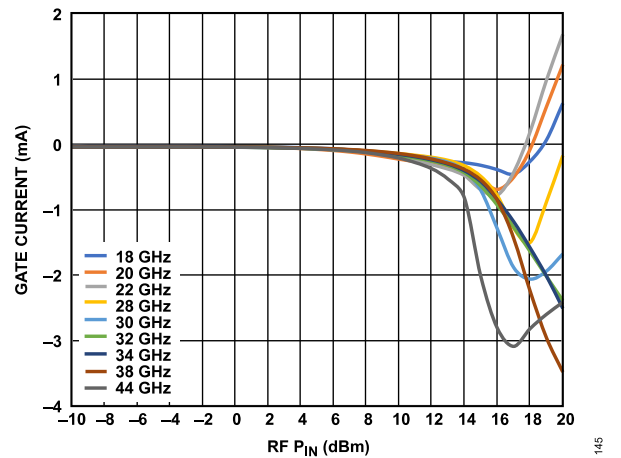

Figure 45. Gate Current ( $I_{GG}$ ) vs.  $RF\ P_{IN}$  at Various Frequencies,  $V_{DD} = 5\text{ V}$ ,  $I_{DQ} = 1400\text{ mA}$

TYPICAL PERFORMANCE CHARACTERISTICS

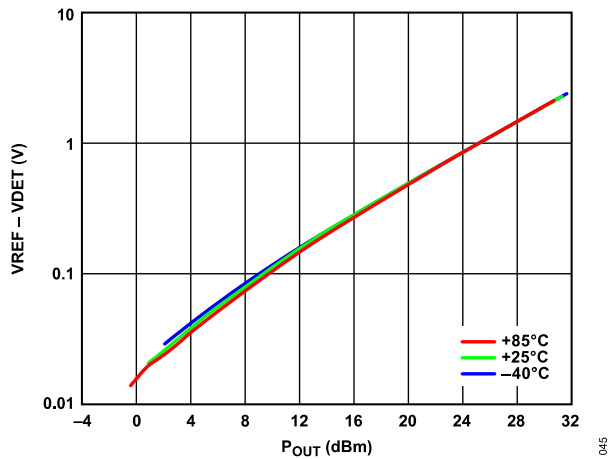

Figure 46. VREF - VDET vs. Output Power for Various Temperatures at 32 GHz

TYPICAL PERFORMANCE CHARACTERISTICS

CONSTANT  $I_{DD}$  OPERATION

Biased with HMC980LP4E active bias controller (see Figure 53),  $T_{CASE} = 25^{\circ}C$ ,  $V_{DD} = 5 V$ , and  $I_{DD} = 1800 mA$  for nominal operation, unless otherwise noted.

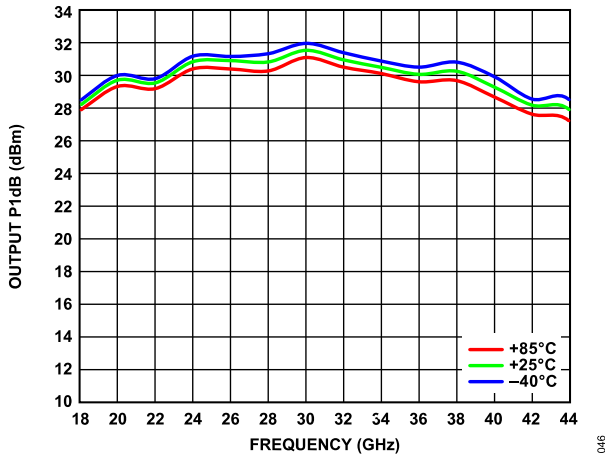

Figure 47. Output P1dB vs. Frequency for Various Temperatures,  $V_{DD} = 5 V$ , Data Measured with Constant  $I_{DD}$

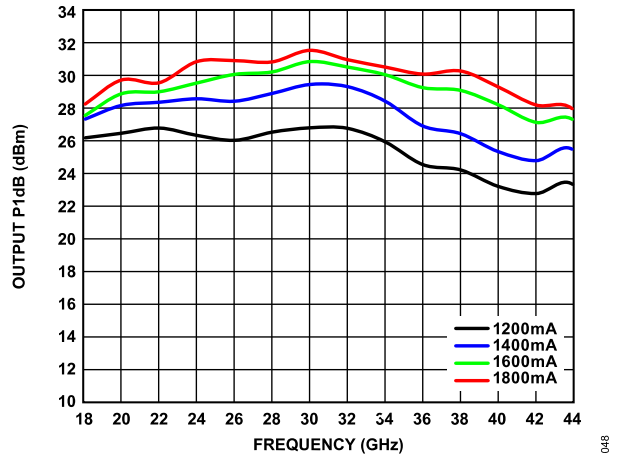

Figure 49. Output P1dB vs. Frequency for Various  $I_{DQ}$ ,  $V_{DD} = 5 V$ , Data Measured with Constant  $I_{DD}$

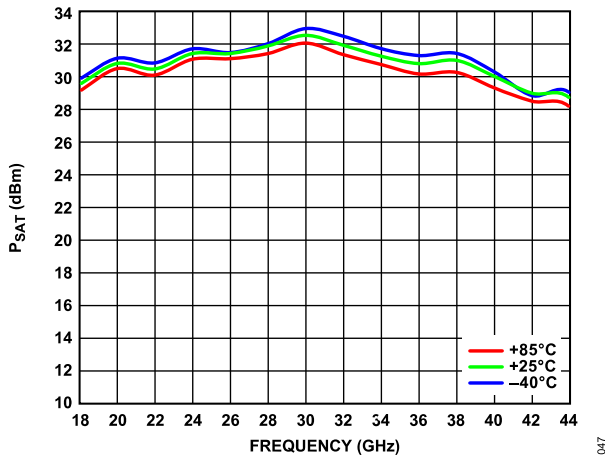

Figure 48.  $P_{SAT}$  vs. Frequency for Various Temperatures,  $V_{DD} = 5 V$ , Data Measured with Constant  $I_{DD}$

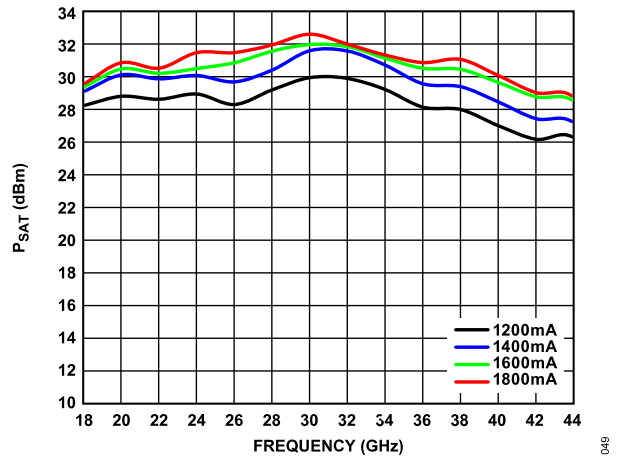

Figure 50.  $P_{SAT}$  vs. Frequency for Various  $I_{DQ}$ ,  $V_{DD} = 5 V$ , Data Measured with Constant  $I_{DD}$

## THEORY OF OPERATION

The simplified architecture of the ADPA7005 power amplifier is shown in [Figure 51](#). The ADPA7005 is a cascaded, three-stage amplifier with a combined gain of 15.5 dB and a  $P_{SAT}$  value of 32 dBm.

The drain current is controlled by the voltage on the VGG1 and VGG2 pins. These pins must be connected together and driven by a negative voltage in the  $-1.5\text{ V}$  to  $0\text{ V}$  range (typical gate bias voltage for a  $I_{DQ}$  bias of 1400 mA is  $-0.685\text{ V}$ ). Simplified bias pin connections to the dedicated gain stages are shown in [Figure 51](#).

A portion of the RF output signal is directionally coupled to a diode for detection of the RF output power. When the diode is dc biased,

the diode rectifies the RF power and makes the RF power available for measurement as a dc voltage at VDET. To allow temperature compensation of VDET, an identical and symmetrically located circuit (minus the coupled RF power) is available via VREF. The difference of  $VREF - VDET$  provides a temperature compensated signal that is proportional to the RF output.

To obtain optimal performance from the ADPA7005 and avoid damaging the device, follow the recommended biasing sequences described in the [Applications Information](#) section.

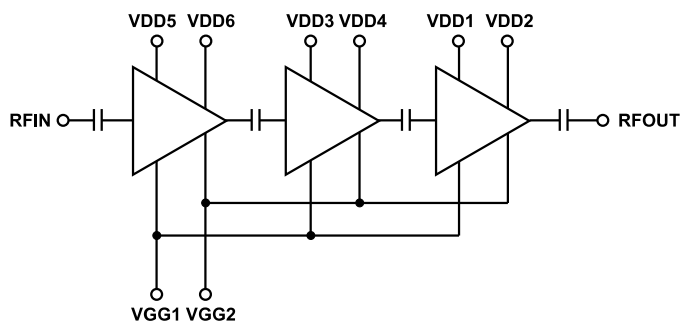

051

Figure 51. Simplified Architecture of ADPA7005

## APPLICATIONS INFORMATION

Figure 52 shows the basic connections for operating the ADPA7005. All measurements for this device were taken using the typical application circuit shown in Figure 52.

Capacitive bypassing is required for all VGGx and VDDx pins. VGG1 and VGG2 are the gate bias pins, and VDD1 to VDD6 are the drain bias pins to the cascaded amplifier.

The power supply and gate voltage decoupling capacitors shown in Figure 52 represent the configuration that was used to characterize and qualify the device. It may be possible to reduce the number of capacitors; however, this modification can vary from system to system. It is recommended to first remove or combine the largest capacitors that are farthest from the device. The following is the recommended bias sequence during power-up:

1. Connect the power supply ground to circuit ground (GND).
2. Set the VGGx gate bias voltages to  $-1.5$  V.
3. Set all VDDx drain bias voltages to  $5$  V.
4. Increase the VGGx gate bias voltages to achieve the quiescent supply current and set  $I_{DQ} = 1400$  mA.

5. Apply the RF signal.

The following is the recommended bias sequence during power-down:

1. Turn off the RF signal.
2. Decrease the VGGx gate bias voltages to  $-1.5$  V to achieve an  $I_{DQ} = 0$  mA (approximately).
3. Decrease all VDDx drain bias voltages to  $0$  V.
4. Increase the VGGx gate bias voltages to  $0$  V.

The  $V_{DD} = 5$  V and  $I_{DQ} = 1400$  mA bias conditions are recommended to optimize overall performance when the gate voltage is being held at a fixed value (note that with the gate voltage held at a fixed value, the drain current,  $I_{DD}$ , increases as the RF input power level is increased, as shown in Figure 41). Unless otherwise noted, the data shown was taken using the recommended bias conditions. Operation of the ADPA7005 at different bias conditions can result in different performance. Biasing the ADPA7005 for higher  $I_{DQ}$  typically results in higher gain and output P1dB at the expense of increased power dissipation (see Table 9).

**Table 9. Power Selection<sup>1, 2</sup>**

$I_{DQ}$ (mA)	Gain (dB)	Output P1dB (dBm)	Output IP3 (dBm)	$P_{DISS}$ (W)	VGGx (V)
1200	15.80	31.89	42.90	6	-0.73
1400	16.20	31.93	41.30	7	-0.68
1600	16.50	31.95	39.55	8	-0.63

<sup>1</sup> Data taken at the following nominal bias conditions:  $V_{DD} = 5$  V,  $T_{CASE} = 25^{\circ}\text{C}$ , frequency = 32 GHz.

<sup>2</sup> Adjust VGG1 and VGG2 from  $-1.5$  V to  $0$  V to achieve the desired  $I_{DQ}$ .

APPLICATIONS INFORMATION

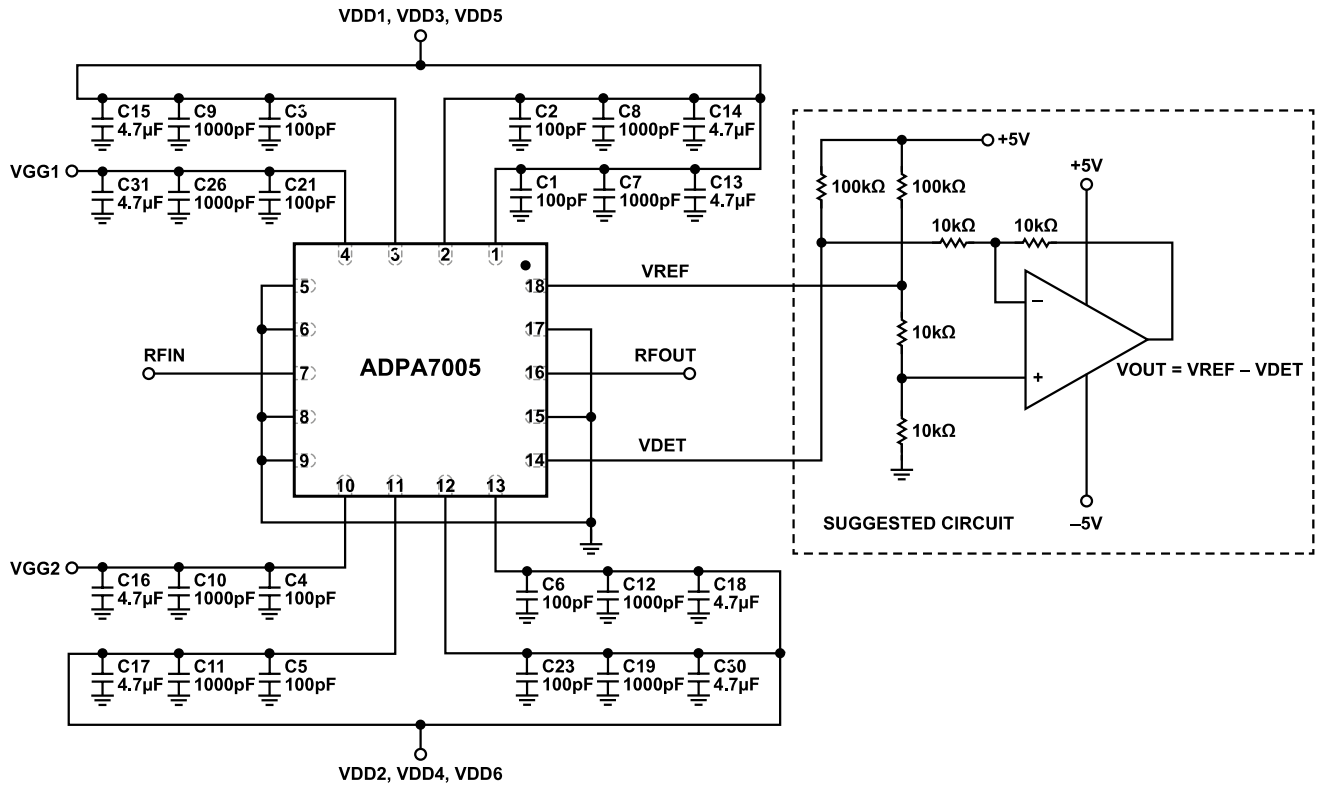

Figure 52. Typical Application Circuit

061

## BIASING ADPA7005 WITH THE HMC980LP4E

The HMC980LP4E is an active bias controller that measures and regulates drain current by automatically adjusting the gate voltage. The HMC980LP4E can control the biasing of RF amplifiers with drain voltages up to 16.5 V and currents up to 1.6 A. The controller provides constant drain current biasing over temperature and device to device variation, and properly sequences gate and drain voltages to ensure the safe operation of the amplifier.

The HMC980LP4E offers self protection in the event of a short circuit, as well as an internal charge pump that generates the negative voltage required on the gate of the ADPA7005. The HMC980LP4E also provides the option to use an external negative voltage source. The HMC980LP4E is also available in die form as the HMC980-DIE.

### APPLICATION CIRCUIT SETUP

Figure 53 shows a schematic of an application circuit using the two HMC980LP4E devices to control the ADPA7005. When using an external negative supply for VNEG, refer to the schematic in Figure 54.

Although the ADPA7005 is specified with a  $I_{DQ}$  of 1400 mA, the operational drain current,  $I_{DRAIN}$ , required to achieve the maximum output power from the ADPA7005 must be set closer to 1800 mA. The  $I_{DRAIN}$  current increases to approximately 1800 mA when the RF input power is 15 dBm, the approximate input compression point (see Figure 41). As a result, a target  $I_{DRAIN}$  of 1800 mA is chosen.

Two HMC980LP4E devices are needed to support current levels at 1800 mA because a single HMC980LP4E device can support a maximum current of 1600 mA. In the application circuit shown in

Figure 53 and Figure 54, the ADPA7005 drain voltage and drain current are set by the following equations:

$$V_{DRAIN} = V_{DD} - I_{DRAIN} \times 0.85 \Omega$$

where:

$V_{DRAIN} = 5$  V, the drain voltage from Pin 17 and Pin 18 of the HMC980LP4E.

$V_{DD} = 5.765$  V, the supply voltage to the HMC980LP4E.

$I_{DRAIN} = 1800$  mA, the constant drain current from Pin 17 and Pin 18 on the HMC980LP4E.

$$R10 = (150 \Omega \times A) / I_{DRAIN}$$

$$R10 = (150 \Omega \times A) / (1.8 A) = 83 \Omega$$

where:

R10 is in ohms.

$I_{DRAIN}$  is in amperes.

### LIMITING VGATE AND VNEG FOR ADPA7005 V<sub>GGX</sub> ABSOLUTE MAXIMUM RATING REQUIREMENT

When using the HMC980LP4E to control the ADPA7005, set the minimum voltages for the VNEG and VGATE pins of the HMC980LP4E to  $-1.5$  V to keep these voltages within the absolute maximum rating limits for all VGG pins of the ADPA7005. To set the minimum voltages, use the R15 and R16 resistors shown in Figure 53 and Figure 54. Refer to the AN-1363 Application Note, *Meeting Biasing Requirements of Externally Biased RF/Microwave Amplifiers with Active Bias Controllers*, for more information and calculations for R15 and R16.

BIASING ADPA7005 WITH THE HMC980LP4E

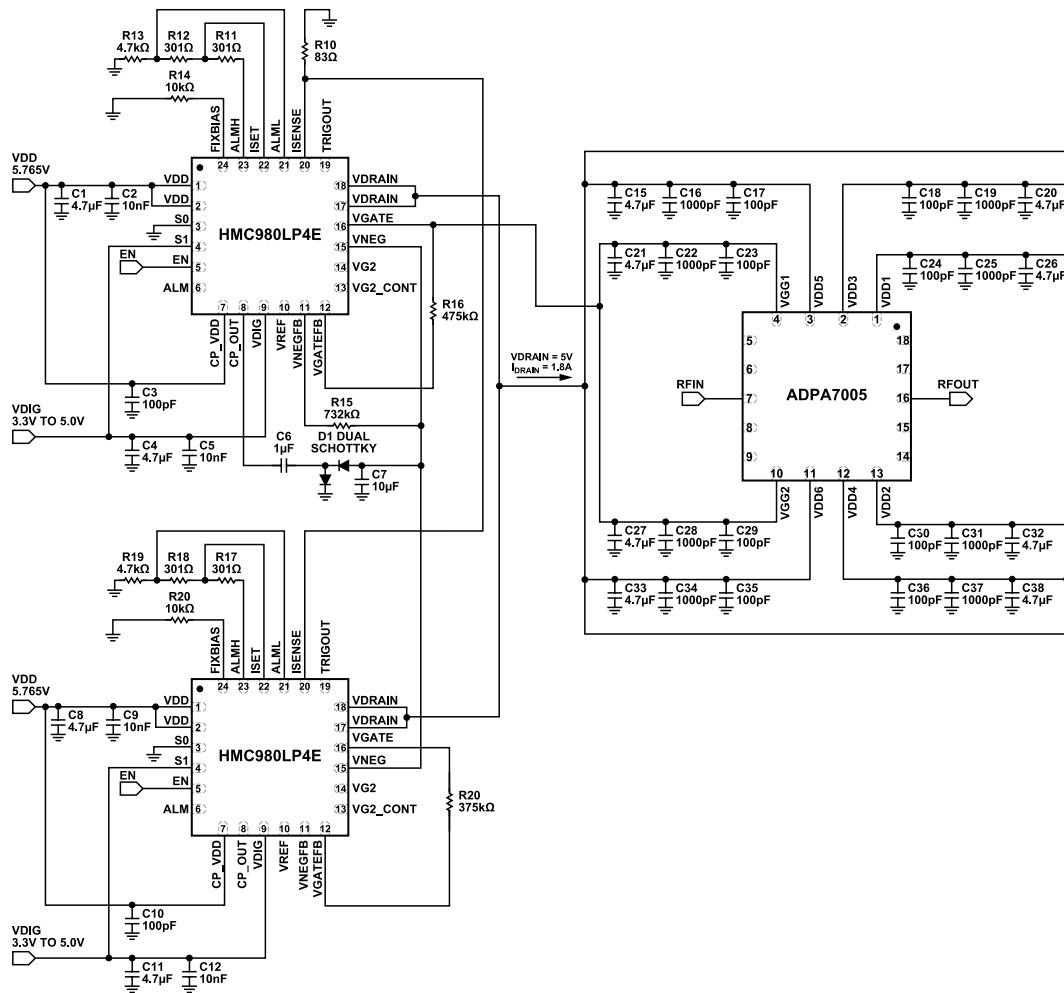

Figure 53. Application Circuit Using Dual HMC980LP4E with ADPA7005

063

BIASING ADPA7005 WITH THE HMC980LP4E

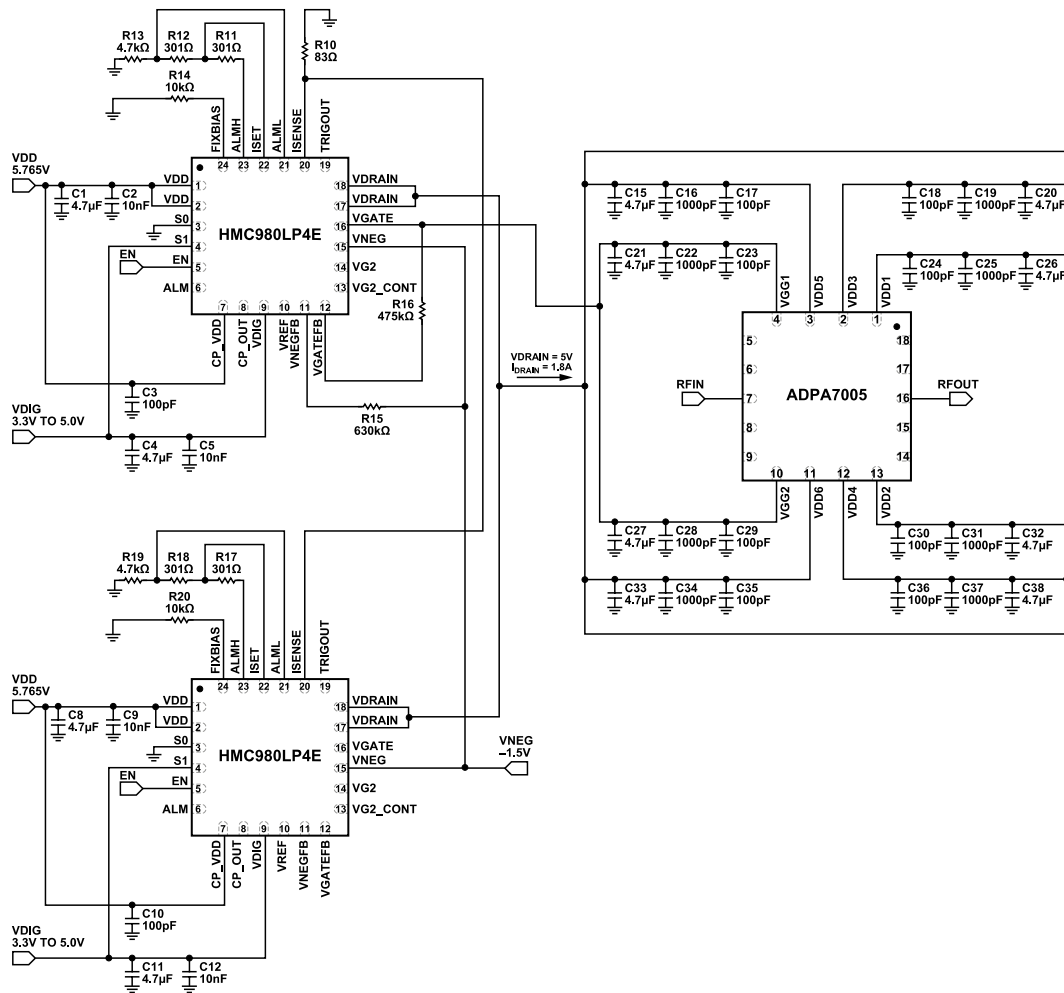

Figure 54. Application Circuit Using Dual HMC980LP4E with ADPA7005 and External Negative Voltage Source

054

## BIASING ADPA7005 WITH THE HMC980LP4E

## HMC980LP4E BIAS SEQUENCE

The dc supply sequencing in the [Power-Up Sequence](#) section and the [Power-Down Sequence](#) section is required to prevent damage to the HMC980LP4E when using it to control the ADPA7005.

## Power-Up Sequence

The power-up sequence is as follows:

1. Set VDIG (Pin 9) of both HMC980LP4E devices to 3.3 V.
2. Set the VDD pins of both HMC980LP4E devices to 5.765 V.
3. Set VNEG (Pin 15) of both HMC980LP4E devices to -1.5 V. This step is not needed if using an internally generated voltage.
4. Set EN (Pin 5) of both HMC980LP4E devices to 3.3 V (transitioning from 0 V to 3.3 V turns on VGATE and VDRAIN).

## Power-Down Sequence

The power-down sequence is as follows:

1. Set EN (Pin 5 of both HMC980LP4E devices) to 0 V (transitioning from 3.3 V to 0 V turns off VDRAIN and VGATE).
2. Set VNEG (Pin 15 of both HMC980LP4E devices) to 0 V. This step is not needed if using an internally generated voltage.
3. Set the VDD pins of both HMC980LP4E devices to 0 V.
4. Set VDIG (Pin 9 of both HMC980LP4E devices) to 0 V.

When the HMC980LP4E bias control circuit is set up, toggle the bias to the ADPA7005 on or off by applying 3.3 V or 0 V, respectively, to the EN pin of the HMC980LP4E. At EN = 3.3 V, the VGATE pin of the HMC980LP4E drops to -1.5 V and the VDRAIN pin of the HMC980LP4E turns on at 5 V. VGATE then rises until  $I_{DRAIN} = 1800$  mA, and the closed control loop regulates  $I_{DRAIN}$  at 1800 mA. When EN = 0 V, VGATE is set to -1.5 V, and VDRAIN is set to 0 V (see [Figure 55](#) and [Figure 56](#)).

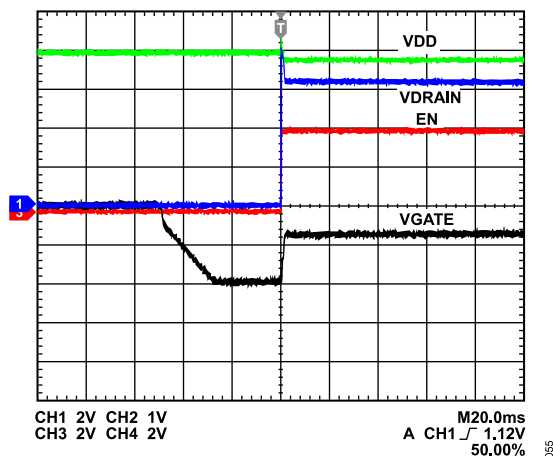

Figure 55. Turn On HMC980LP4E Outputs to ADPA7005

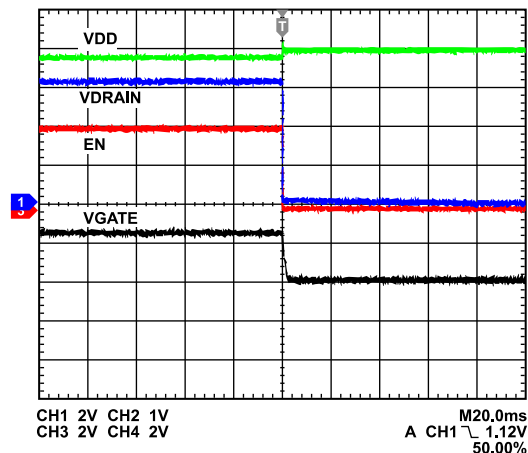

Figure 56. Turn Off HMC980LP4E Outputs to ADPA7005

BIASING ADPA7005 WITH THE HMC980LP4E

CONSTANT DRAIN CURRENT BIASING VS. CONSTANT GATE VOLTAGE BIASING

The HMC980LP4E uses a feedback loop to continuously adjust VGATE to maintain a constant drain current over dc supply variation, temperature, RF input and output level, and device to device variation. Constant drain current bias is the preferred method for reducing time in calibration procedures and for maintaining consistent performance over time.

In comparison to a constant gate voltage bias, where the current increases when RF power is applied, a constant drain current has a slightly lower output P1dB. This output P1dB is shown in Figure 60, where the RF performance is slightly lower than constant gate bias voltage operation due to a lower drain current at high input power (see Figure 57) as the HMC980LP4E reaches 1 dB compression.

The output P1dB performance for constant drain current bias can be increased toward constant gate voltage bias performance by increasing the set current toward the I<sub>DD</sub> value it reaches under RF drive in the constant gate voltage bias condition (see Figure 60).

The limit of increasing drain current under the constant current operation is set by the thermal limitations found in Table 5 with the maximum power dissipation specification. As the I<sub>DD</sub> increase continues, the actual output P1dB does not continue to increase indefinitely but the power dissipation increases linearly. Therefore, take the trade-off between the power dissipation and output P1dB performance into consideration when using constant drain current biasing.

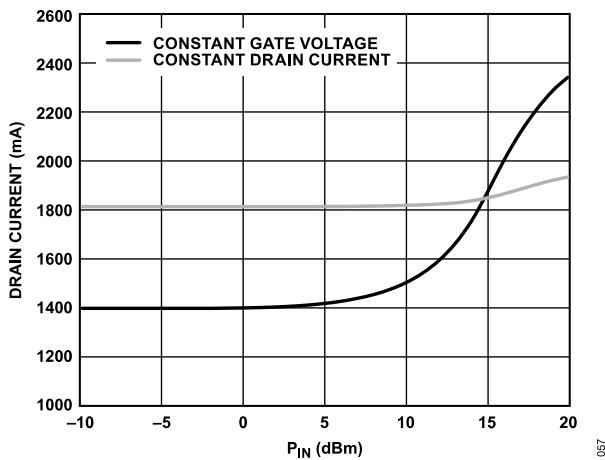

Figure 57. Drain Current vs. P<sub>IN</sub>, V<sub>DD</sub> = 5 V, Frequency = 32 GHz, Constant Drain Current Bias (I<sub>DRAIN</sub> Setpoint = 1.8 A) and Constant Gate Voltage Bias (V<sub>GGx</sub> ≈ -0.68 V)

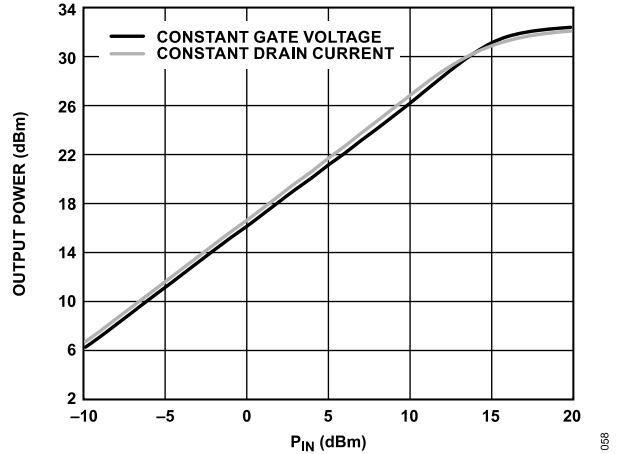

Figure 58. Output Power vs. P<sub>IN</sub>, V<sub>DD</sub> = 5 V, Frequency = 32 GHz, Constant Drain Current Bias (I<sub>DRAIN</sub> Setpoint = 1.8 A) and Constant Gate Voltage Bias (V<sub>GGx</sub> ≈ -0.68 V)

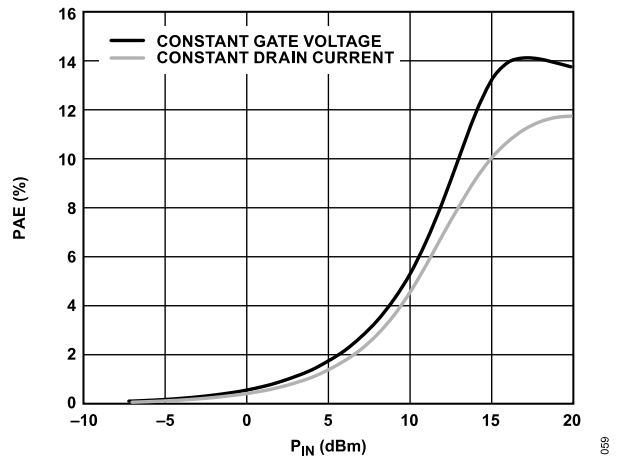

Figure 59. PAE vs. P<sub>IN</sub>, V<sub>DD</sub> = 5 V, Frequency = 32 GHz, Constant Drain Current Bias (I<sub>DRAIN</sub> Setpoint = 1.8 A) and Constant Gate Voltage Bias (V<sub>GGx</sub> ≈ -0.68 V)

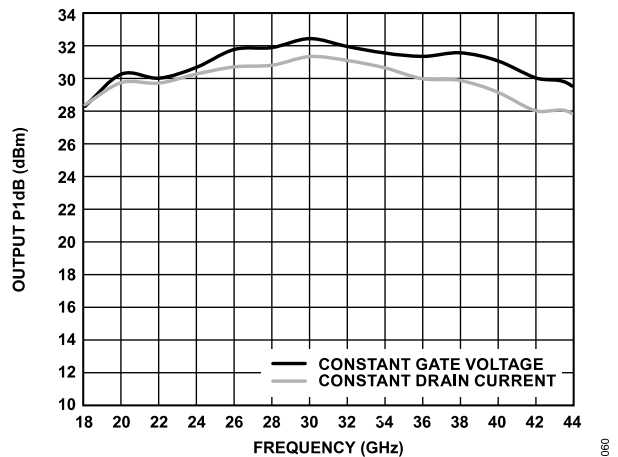

Figure 60. Output P1dB vs. Frequency, V<sub>DD</sub> = 5 V, Constant Drain Current Bias (I<sub>DRAIN</sub> Setpoint = 1.8 A) and Constant Gate Voltage Bias (V<sub>GGx</sub> ≈ -0.68 V)

OUTLINE DIMENSIONS

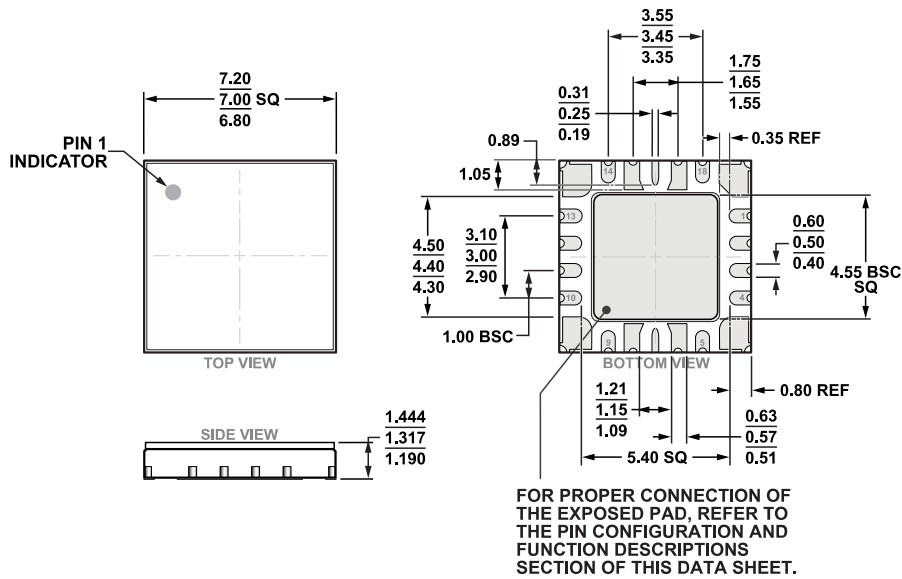

Figure 61. 18-Terminal Ceramic Leadless Chip Carrier with Heat Sink [LCC\_HS] (EH-18-1)  
Dimensions shown in millimeters

ORDERING GUIDE

Model <sup>1</sup>	Temperature Range	Package Description	Package Option
ADPA7005AEHZ	-40°C to +85°C	18-Terminal Ceramic Leadless Chip Carrier with Heat Sink [LCC_HS]	EH-18-1
ADPA7005AEHZ-R7	-40°C to +85°C	18-Terminal Ceramic Leadless Chip Carrier with Heat Sink [LCC_HS]	EH-18-1

<sup>1</sup> Z = RoHS Compliant Part.

EVALUATION BOARDS

Table 10.

Model <sup>1</sup>	Description
ADPA7005-EVALZ	Evaluation Board

<sup>1</sup> Z = RoHS-Compliant Part.

## Looking for pricing, stock, or lifecycle information?

Click below to explore more details on WIN SOURCE:

- ⊖ [View ADPA7005-EVALZ on WIN SOURCE](#)
- ⊖ [Analog Devices Inc. Information](#)

## Optimize Your Supply Chain with WIN SOURCE Solutions

- ✓ Global Sourcing Solution
- ✓ Obsolete Management
- ✓ Cost Control Management
- ✓ Shortage Management
- ✓ Alternative Solution
- ✓ Excess Inventory Management