



General Description

The DSC2110 and DSC2210 series of programmable, high-performance CMOS oscillators utilize a proven silicon MEMS technology to provide excellent jitter and stability while incorporating high output frequency flexibility and drive strength control. DSC2110 and DSC2210 allow the user to modify the frequency and CMOS drive strength using I²C or SPI interface, respectively. User can also select from two pre-programmed default output frequencies using the control pin.

DSC2110 and DSC2210 are packaged in 14-pin 3.2x2.5 mm QFN packages and available in temperature grades from Ext. Commercial to Automotive.

Block Diagram

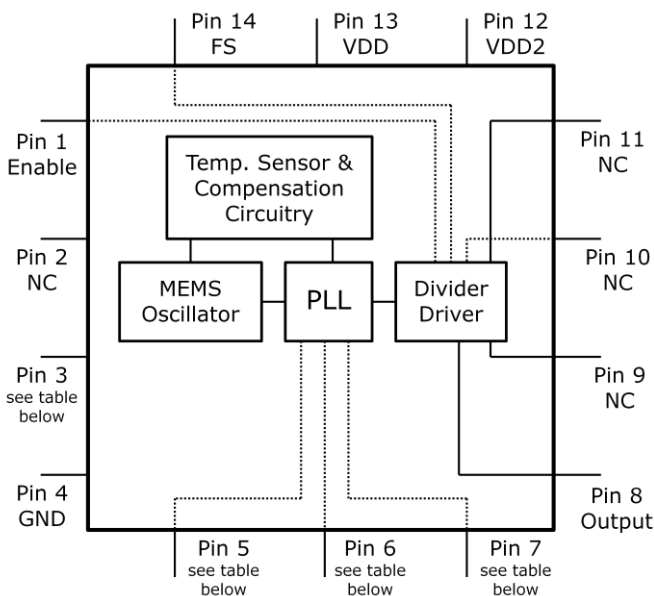

Pin #	DSC2110 (I ² C)	DSC2210 (SPI)
3	NC	SCLK
5	SDA	MOSI
6	SCL	MISO
7	CS_bar	SS

Features

- **Low RMS Phase Jitter: <1 ps (typ)**
- **High Stability: ±10, ±25, ±50 ppm**
- **Wide Temperature Range**
 - Automotive: -55° to 125° C
 - Ext. Industrial: -40° to 105° C
 - Industrial: -40° to 85° C
 - Ext. commercial: -20° to 70° C
- **High Supply Noise Rejection: -50 dBc**
- **I²C/SPI Programmable Freq & Drive**
- **Short Lead Times: 2 Weeks**
- **Wide Freq. Range:**
 - CMOS Output: 2.3 to 170 MHz
- **Miniature Footprint of 3.2x2.5mm**
- **Excellent Shock & Vibration Immunity**
 - Qualified to MIL-STD-883
- **High Reliability**
 - 20x better MTF than quartz oscillators
- **Supply Range of 2.25 to 3.6 V**
- **Lead Free & RoHS Compliant**

Applications

- **Consumer Electronics**
- **Storage Area Networks**
 - SATA, SAS, Fibre Channel
- **Passive Optical Networks**
 - EPON, 10G-EPON, GPON, 10G-PON
- **Ethernet**
 - 1G, 10GBASE-T/KR/LR/SR, and FCoE
- **HD/SD/SDI Video & Surveillance**
- **PCI Express**

Pin Description

Pin No.	Pin Name	Pin Type	Description
1	Enable	I	Enables outputs when high and disables when low
2	NC	NA	Leave unconnected or grounded
3	NC	NA	DSC2110: Leave unconnected or grounded
	SCLK	I	DSC2210: Serial clock from master
4	GND	Power	Ground
5	SDA	I	DSC2110: I ² C Serial Data
	MOSI		DSC2210: SPI Serial Data from Master to Slave
6	SCL	I	DSC2110: I ² C Serial Clock
	MISO	O	DSC2210: SPI Serial Data from Slave to Master
7	CS_bar	I	DSC2110: I ² C Chip Select (Active Low)
	SS	I	DSC2210: SPI Slave Select (Active Low)
8	Output1	O	CMOS output 1
9	NC	NA	Leave unconnected or grounded
10	NC	NA	Leave unconnected or grounded
11	NC	NA	Leave unconnected or grounded
12	VDD2	Power	Power Supply
13	VDD	Power	Power Supply
14	FS	I	Default output clock frequency bit

Operational Description

The DSC2110/2210 is a CMOS oscillator consisting of a MEMS resonator and a support PLL IC. The CMOS output is generated through independent 8-bit programmable dividers from the output of the internal PLL.

DSC2110/2210 allows for easy programming of the output frequencies using I²C/SPI interface. Upon power-up, the initial output frequency is controlled by an internal pre-programmed memory (OTP). This memory stores all coefficients required by the PLL for two different default frequencies. The control pin (FS) selects the initial frequency. Once the device is powered up, a new output frequency can be programmed. Programming details are provided in the **Programming Guide**. Standard default frequencies are described in the following sections. Discera supports customer defined versions of the DSC2110/2210.

When Enable (pin 1) is floated or connected to VDD, the DSC2110/2210 is in operational

mode. Driving Enable to ground will disable both output drivers (hi-impedance mode).

The DSC2110/2210 has programmable output drive strength, which can be controlled via I²C/SPI. Table 1 displays typical rise / fall times for the output with a 15pf load capacitance as a function of these control bits at VDD=3.3V and room temperature.

Table 1. Rise/Fall times for drive strengths

	Output Drive Strength Bits [OXS2, OXS1, OXS0] - Default [111] X=1 for output1, and 2 for output2							
	000	001	010	011	100	101	110	111
tr (ns)	2.1	1.7	1.6	1.4	1.3	1.3	1.2	1.1
tf (ns)	2.5	2.4	2.4	2	1.8	1.6	1.3	1.3

Output Clock Frequencies

Table 2 lists the standard frequency configurations and the associated ordering information to be used in conjunction with the ordering code. Customer defined combinations are available.

Table 2. Pre-programmed pin-selectable output frequency combinations

Ordering Info	Freq (MHz)	Select Bit [FS] - Default is [1]	
		0	1
A0001	f _{OUT}	27	24
A0002	f _{OUT}	155.52	106.25
A0003	f _{OUT}	25	75
A0004	f _{OUT}	72	74.25
A0005	f _{OUT}	27	50
A0006	f _{OUT}	16	13.56
A0007	f _{OUT}	96	55
A0008	f _{OUT}	25	50
A0009	f _{OUT}	55.296	27.648
A00010	f _{OUT}	27.648	55.296
AXXXX	f _{OUT}	Contact factory for additional configurations.	

Frequency select bit are weakly tied high so if left unconnected the default setting will be [1] and the device will output the associated frequency highlighted in **Bold**.

Absolute Maximum Ratings

Item	Min	Max	Unit	Condition
Supply Voltage	-0.3	+4.0	V	
Input Voltage	-0.3	V _{DD} +0.3	V	
Junction Temp	-	+150	°C	
Storage Temp	-55	+150	°C	
Soldering Temp	-	+260	°C	40sec max.
ESD	-		V	
HBM		4000		
MM		400		
CDM		1500		

Note: 1000+ years of data retention on internal memory

Ordering Code

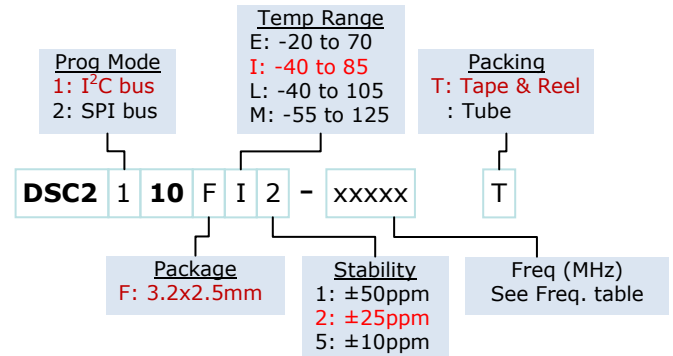

Specifications (Unless specified otherwise: T=25° C, max CMOS drive strength)

Parameter	Condition	Min.	Typ.	Max.	Unit	
Supply Voltage ¹	V _{DD}	2.25		3.6	V	
Supply Current	I _{DD} EN pin low – output is disabled		21	23	mA	
Frequency Stability	Includes frequency variations due to initial tolerance, temp. and power supply voltage			±10 ±25 ±50	ppm	
Aging	1 year @25°C			±5	ppm	
Startup Time ²	T=25°C			5	ms	
Input Logic Levels						
Input logic high	V _{IH}	0.75xV _{DD}		-	V	
Input logic low	V _{IL}	-		0.25xV _{DD}		
Output Disable Time ³	t _{DA}			5	ns	
Output Enable Time	t _{EN}			20	ns	
Pull-Up Resistor ⁴	Pull-up exists on all digital IO		40		kΩ	
CMOS Output						
Supply Current ⁴	I _{DD} EN pin high – output is enabled C _L =15pF, F _O =125 MHz		31	35	mA	
Output Logic Levels						
Output logic high	V _{OH}	0.9xV _{DD}		-	V	
Output logic low	V _{OL}	-		0.1xV _{DD}		
Output Transition time ³						
Rise Time	t _R	20% to 80% C _L =15pf	1.1	2	ns	
Fall Time	t _F		1.3	2		
Frequency	f ₀	Commercial/Industrial temp range Automotive temp range	2.3		170 100	MHz
Output Duty Cycle	SYM		45		55	%
Period Jitter	J _{PER}	F _O =125 MHz		3		ps _{RMS}
Integrated Phase Noise	J _{CC}	200kHz to 20MHz @ 125MHz 100kHz to 20MHz @ 125MHz 12kHz to 20MHz @ 125MHz		0.3 0.38 1.7		ps _{RMS}

Notes:

- Pin 4 V_{DD} should be filtered with 0.01µf capacitor.
- t_{SU} is time to 100PPM stable output frequency after V_{DD} is applied and outputs are enabled.
- Output Waveform and Test Circuit figures below define the parameters.
- Output is enabled if Enable pad is floated or not connected.

Nominal Performance Parameters (Unless specified otherwise: T=25° C, V_{DD}=3.3 V)

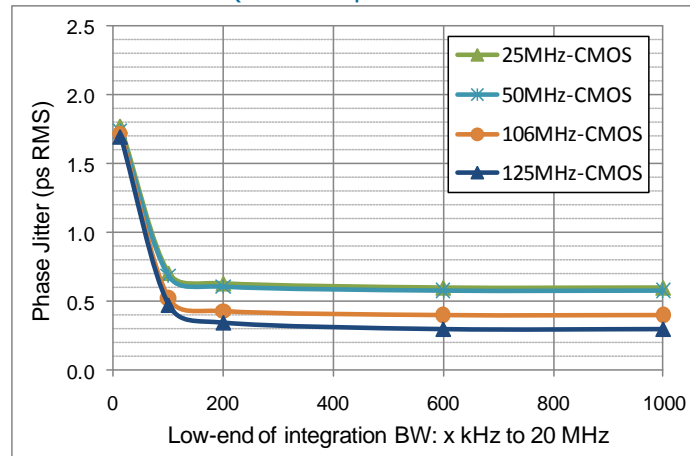

CMOS Phase jitter (integrated phase noise)

Output Waveform: CMOS

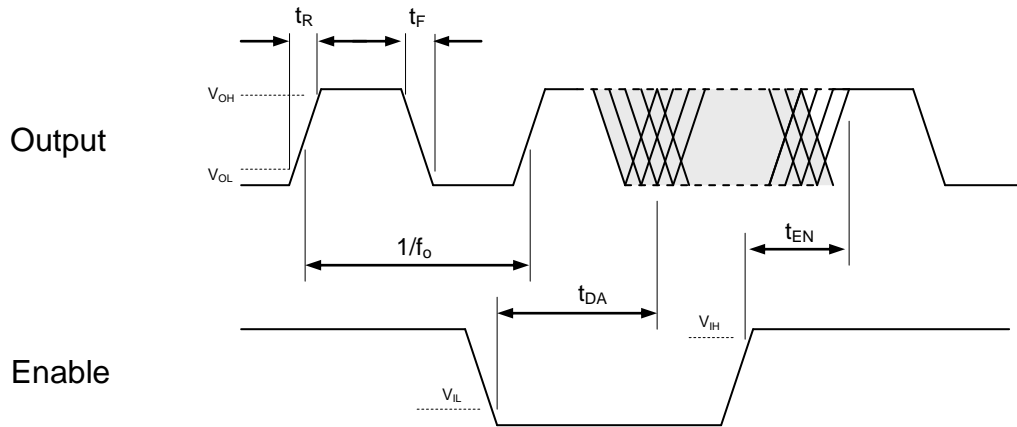

Solder Reflow Profile

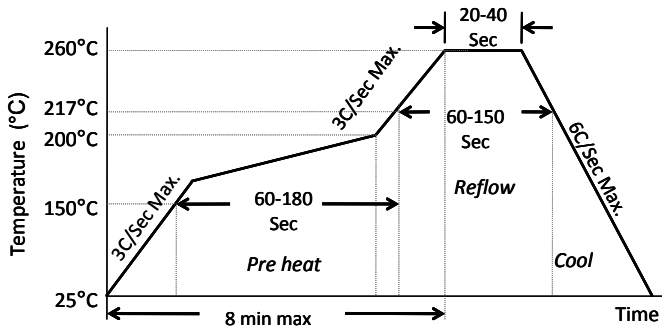

MSL 1 @ 260°C refer to JSTD-020C	
Ramp-Up Rate (200°C to Peak Temp)	3°C/Sec Max.
Preheat Time 150°C to 200°C	60-180 Sec
Time maintained above 217°C	60-150 Sec
Peak Temperature	255-260°C
Time within 5°C of actual Peak	20-40 Sec
Ramp-Down Rate	6°C/Sec Max.
Time 25°C to Peak Temperature	8 min Max.

Package Dimensions

3.2 x 2.5 mm 14 Lead Plastic Package

External Dimensions

units: mm[inch]

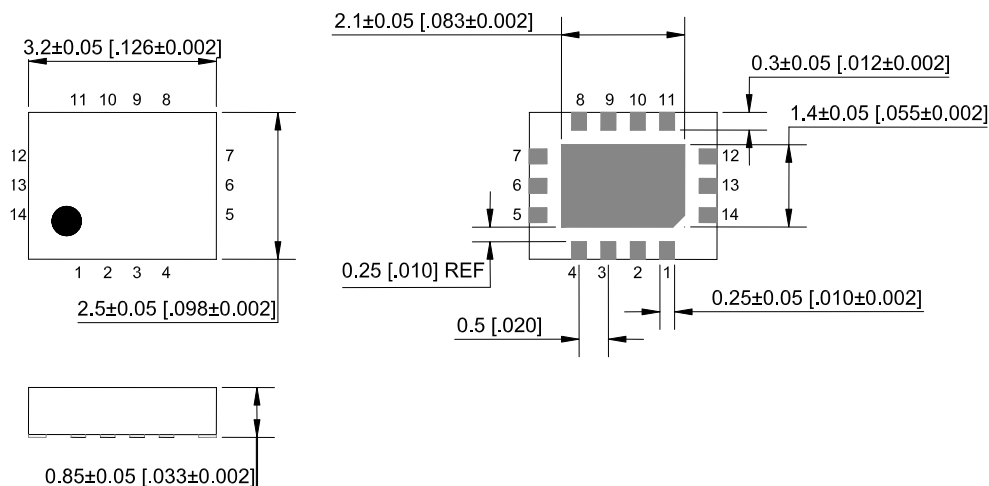

Recommended Solder Pad Layout

units: mm[inch]

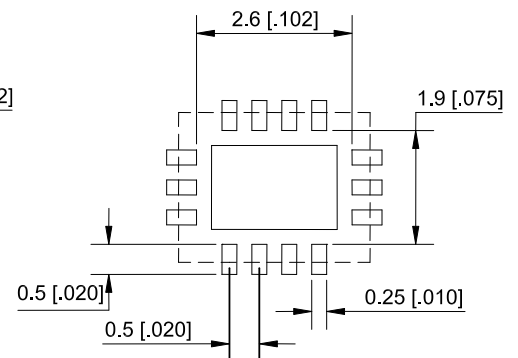

Disclaimer:

Discera makes no warranty of any kind, express or implied, with regard to this material, including, but not limited to, the implied warranties of merchantability and fitness for a particular purpose. Discera reserves the right to make changes without further notice to materials described herein. Discera does not assume any liability arising from the application or use of any product or circuit described herein. Discera does not authorize its products for use as critical components in life-support systems where a malfunction or failure may reasonably be expected to result in significant injury to the user. The inclusion of Discera's product in a life-support systems application implies that the manufacturer assumes all risk of such use and in doing so indemnifies Discera against all charges.

Looking for pricing, stock, or lifecycle information?

Click below to explore more details on WIN SOURCE:

 [View DSC2210FI2-A0006T on WIN SOURCE](#)

 [Microchip Technology](#) Information

Optimize Your Supply Chain with WIN SOURCE Solutions

-  Global Sourcing Solution
-  Obsolete Management
-  Cost Control Management
-  Shortage Management
-  Alternative Solution
-  Excess Inventory Management