



**THE DATASHEET OF
DSC2230FI2-C0007**





General Description

The DSC2130 and DSC2230 series of programmable, high-performance LVDS oscillators utilizes a proven silicon MEMS technology to provide excellent jitter and stability while incorporating high output frequency flexibility. DSC2130 and DSC2230 allow the user to modify the output frequency using I²C or SPI interface, respectively. User can also select from two pre-programmed default output frequencies using the control pin.

DSC2130 and DSC2230 are packaged in 14-pin 3.2x2.5 mm QFN packages and available in temperature grades from Ext. Commercial to industrial.

Block Diagram

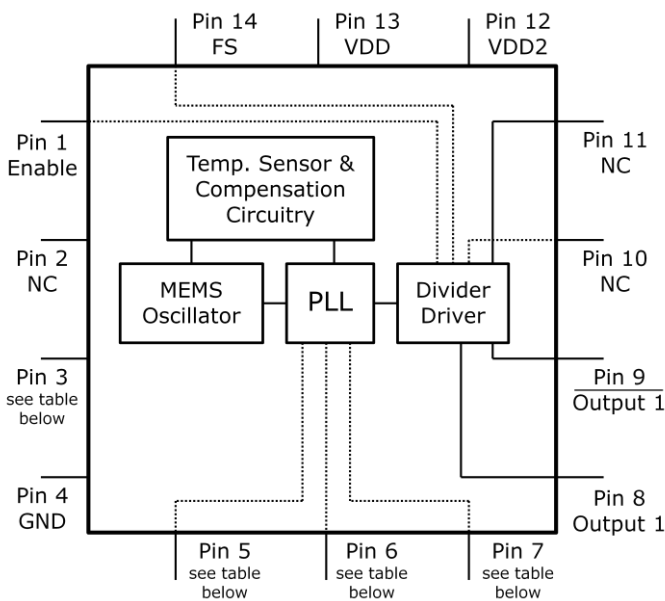

Pin #	DSC2130 (I ² C)	DSC2230 (SPI)
3	NC	SCLK
5	SDA	MOSI
6	SCL	MISO
7	CS_bar	SS

Features

- **Low RMS Phase Jitter: <1 ps (typ)**
- **High Stability: ±10, ±25, ±50 ppm**
- **Wide Temperature Range**
 - Industrial: -40° to 85° C
 - Ext. commercial: -20° to 70° C
- **High Supply Noise Rejection: -50 dBc**
- **I²C/SPI Programmable Output Freq**
- **Short Lead Times: 2 Weeks**
- **Wide Freq. Range:**
 - LVDS Output: 2.3 to 460 MHz
- **Miniature Footprint of 3.2x2.5mm**
- **Excellent Shock & Vibration Immunity**
 - Qualified to MIL-STD-883
- **High Reliability**
 - 20x better MTF than quartz oscillators
- **Supply Range of 2.25 to 3.6 V**
- **Lead Free & RoHS Compliant**

Applications

- **Consumer Electronics**
- **Storage Area Networks**
 - SATA, SAS, Fibre Channel
- **Passive Optical Networks**
 - EPON, 10G-EPON, GPON, 10G-PON
- **Ethernet**
 - 1G, 10GBASE-T/KR/LR/SR, and FCoE
- **HD/SD/SDI Video & Surveillance**
- **PCI Express**

Pin Description

Pin No.	Pin Name	Pin Type	Description
1	Enable	I	Enables outputs when high and disables when low
2	NC	NA	Leave unconnected or grounded
3	NC	NA	DSC2130: Leave unconnected or grounded
	SCLK	I	DSC2230: Serial clock from master
4	GND	Power	Ground
5	SDA	I	DSC2130: I ² C Serial Data
	MOSI		DSC2230: SPI Serial Data from Master to Slave
6	SCL	I	DSC2130: I ² C Serial Clock
	MISO	O	DSC2230: SPI Serial Data from Slave to Master
7	CS_bar	I	DSC2130: I ² C Chip Select (Active Low)
	SS	I	DSC2230: SPI Slave Select (Active Low)
8	Output1+	O	Positive LVDS Output
9	Output1-	O	Negative LVDS Output
10	NC	NA	Leave unconnected or grounded
11	NC	NA	Leave unconnected or grounded
12	VDD2	Power	Power Supply
13	VDD	Power	Power Supply
14	FS	I	Default output clock frequency bit

Operational Description

The DSC2130/2230 is a LVDS oscillator consisting of a MEMS resonator and a support PLL IC. The LVDS output is generated through independent 8-bit programmable dividers from the output of the internal PLL.

DSC2130/2230 allows for easy programming of the output frequencies using I²C/SPI interface. Upon power-up, the initial output frequency is controlled by an internal pre-programmed memory (OTP). This memory stores all coefficients required by the PLL for two different default frequencies. The control

pin (FS) selects the initial frequency. Once the device is powered up, a new output frequency can be programmed. Programming details are provided in the **Programming Guide**. Standard default frequencies are described in the following sections. Discera supports customer defined versions of the DSC2130/2230.

When Enable (pin 1) is floated or connected to VDD, the DSC2130/2230 is in operational mode. Driving Enable to ground will disable both output drivers (hi-impedance mode).

Output Clock Frequencies

Table 2 lists the standard frequency configurations and the associated ordering information to be used in conjunction with the ordering code. Customer defined combinations are available.

Table 2. Pre-programmed pin-selectable output frequency combinations

Ordering Info	Freq (MHz)	Select Bit [FS] – Default is [1]	
		0	1
C0001	f _{OUT}	148.352	74.1758
C0002	f _{OUT}	100	0*
C0003	f _{OUT}	100	150
C0004	f _{OUT}	148.5	148.35
C0005	f _{OUT}	315	0*
CXXXX	f _{OUT}	Contact factory for additional configurations.	

Frequency select bit are weakly tied high so if left unconnected the default setting will be [1] and the device will output the associated frequency highlighted in **Bold**.

0* – denotes invalid selection, output frequency is not specified.

Absolute Maximum Ratings

Item	Min	Max	Unit	Condition
Supply Voltage	-0.3	+4.0	V	
Input Voltage	-0.3	V _{DD} +0.3	V	
Junction Temp	-	+150	°C	
Storage Temp	-55	+150	°C	
Soldering Temp	-	+260	°C	40sec max.
ESD	-		V	
HBM		4000		
MM		400		
CDM		1500		

Note: 1000+ years of data retention on internal memory

Ordering Code

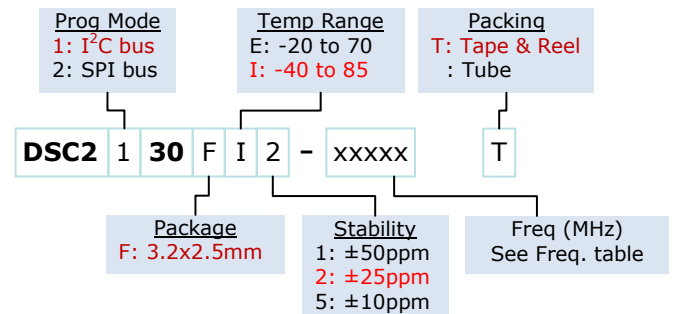

Specifications (Unless specified otherwise: T=25° C)

Parameter	Condition	Min.	Typ.	Max.	Unit
Supply Voltage ¹	V _{DD}	2.25		3.6	V
Supply Current	I _{DD} EN pin low – output is disabled		21	23	mA
Supply Current ²	I _{DD} Output Enabled, R _L =100Ω		29	32	mA
Frequency Stability	Includes frequency variations due to initial tolerance, temp. and power supply voltage			±10 ±25 ±50	ppm
Aging	Δf 1 year @25°C			±5	ppm
Startup Time ²	t _{SU} T=25°C			5	ms
Input Logic Levels					
Input logic high	V _{IH}	0.75xV _{DD}		-	V
Input logic low	V _{IL}	-		0.25xV _{DD}	
Output Disable Time ³	t _{DA}			5	ns
Output Enable Time	t _{EN}			20	ns
Pull-Up Resistor ⁴	Pull-up exists on all digital IO		40		kΩ
LVDS Outputs					
Output Offset Voltage	R=100Ω Differential	1.125		1.4	V
Delta Offset Voltage				50	mV
Pk to Pk Output Swing	Single-Ended		350		mV
Output Transition time ⁴					
Rise Time	t _R 20% to 80% R _L =50Ω, C _L = 2pF		200		ps
Fall Time	t _F				
Frequency	f ₀ Single Frequency	2.3		460	MHz
Output Duty Cycle	SYM Differential	48		52	%
Period Jitter ⁵	J _{PER} F ₀ =156.25 MHz		2.5		ps _{RMS}
Integrated Phase Noise	J _{CC} 200kHz to 20MHz @156.25MHz 100kHz to 20MHz @156.25MHz 12kHz to 20MHz @156.25MHz		0.28 0.4 1.7		ps _{RMS}

Notes:

- Pin 4 V_{DD} should be filtered with 0.01uF capacitor.
- Output is enabled if Enable pad is floated or not connected.
- t_{SU} is time to 100PPM stable output frequency after V_{DD} is applied and outputs are enabled.
- Output Waveform and Test Circuit figures below define the parameters.
- Period Jitter includes crosstalk from adjacent output.

Nominal Performance Parameters (Unless specified otherwise: T=25° C, V_{DD}=3.3 V)

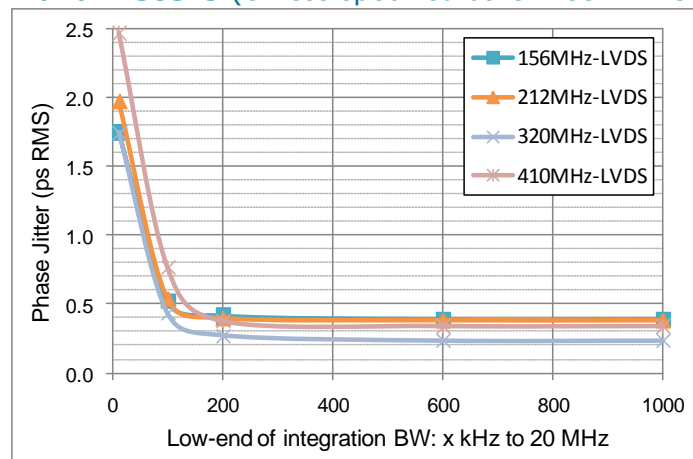

LVDS Phase jitter (integrated phase noise)

Output Waveform: LVDS

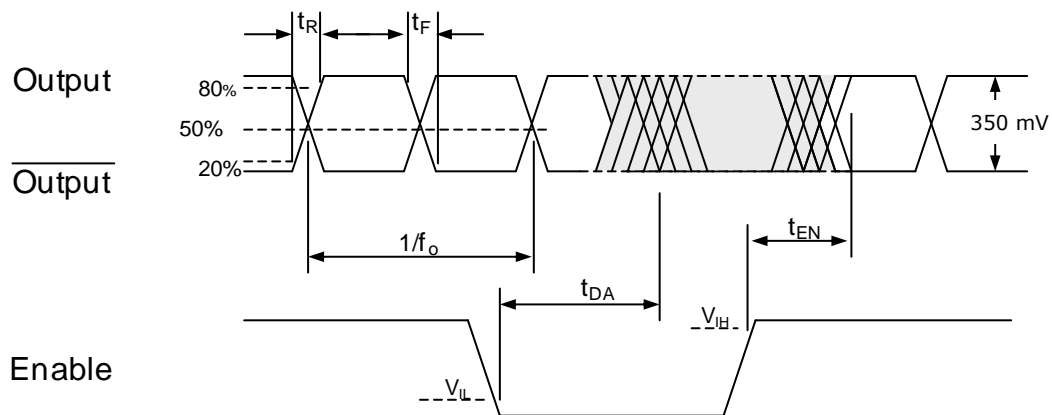

Solder Reflow Profile

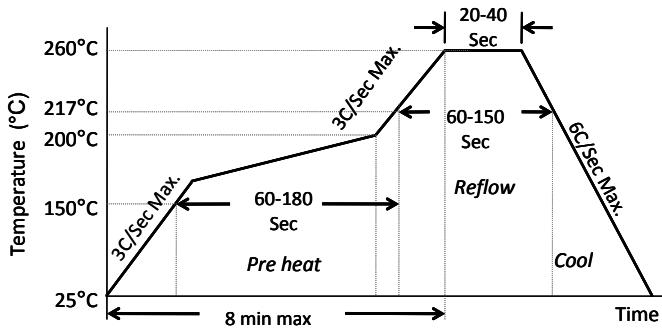

MSL 1 @ 260°C refer to JSTD-020C	
Ramp-Up Rate (200°C to Peak Temp)	3°C/Sec Max.
Preheat Time 150°C to 200°C	60-180 Sec
Time maintained above 217°C	60-150 Sec
Peak Temperature	255-260°C
Time within 5°C of actual Peak	20-40 Sec
Ramp-Down Rate	6°C/Sec Max.
Time 25°C to Peak Temperature	8 min Max.

Package Dimensions

3.2 x 2.5 mm 14 Lead Plastic Package

External Dimensions

units: mm[inch]

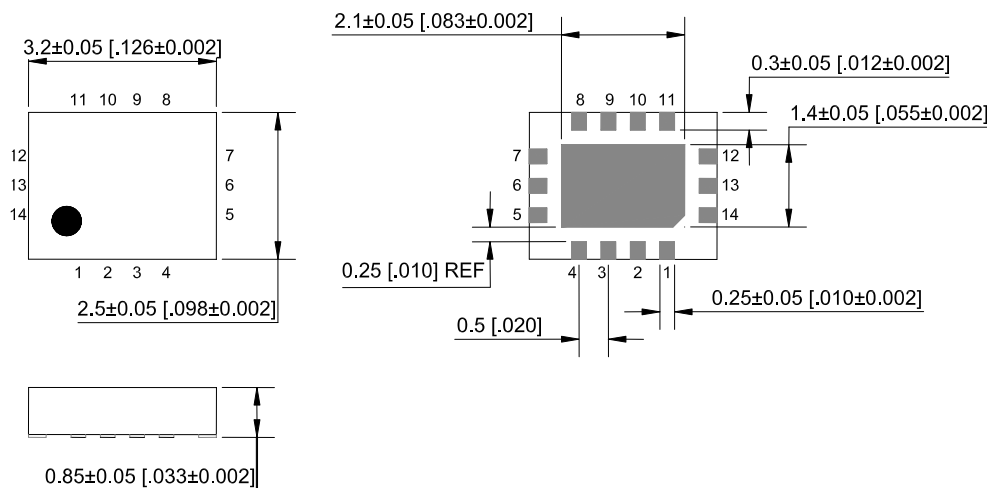

Recommended Solder Pad Layout

units: mm[inch]

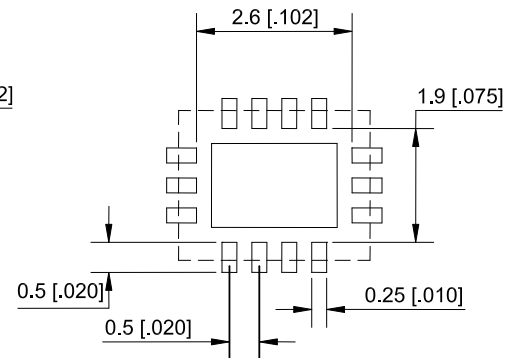

Disclaimer:

Discera makes no warranty of any kind, express or implied, with regard to this material, including, but not limited to, the implied warranties of merchantability and fitness for a particular purpose. Discera reserves the right to make changes without further notice to materials described herein. Discera does not assume any liability arising from the application or use of any product or circuit described herein. Discera does not authorize its products for use a critical components in life-support systems where a malfunction or failure may reasonably be expected to result in significant injury to the user. The inclusion of Discera's product in a life-support systems application implies that the manufacturer assumes all risk of such use and in doing so indemnifies Discera against all charges.

Looking for pricing, stock, or lifecycle information?

Click below to explore more details on WIN SOURCE:

 [View DSC2230FI2-C0007](#) on WIN SOURCE

 [Microchip Technology](#) Information

Optimize Your Supply Chain with WIN SOURCE Solutions

-  Global Sourcing Solution
-  Obsolete Management
-  Cost Control Management
-  Shortage Management
-  Alternative Solution
-  Excess Inventory Management