



**THE DATASHEET OF
USBQNM50405CE3/TR7**





500 W, Non-Magnetic Low Capacitance Bidirectional TVS array

**HALOGEN
FREE**

DESCRIPTION

This Transient Voltage Suppressor (TVS) is assembled in a non-magnetic QFN-143 package with a leadframe 100% free of iron. It has the same pinout and footprint as the SOT-143 package and is aimed at applications in MRI machines and other magnetic environments where the use of ferrous metals is not acceptable. The configuration gives protection to 1 bi-directional data or interface line. It is designed for use in applications where low capacitance protection is required at the board level from voltage transients caused by electrostatic discharge (ESD) as defined in IEC 61000-4-2, electrical fast transients (EFT) per IEC 61000-4-4 and the secondary effects of lightning. These TVS arrays have a peak power rating of 500 watts for an 8/20 μ s pulse (figure 1). With a capacitance of only 3 pF, this part can provide protection to very fast data lines including USB at 900 Mbits/sec.

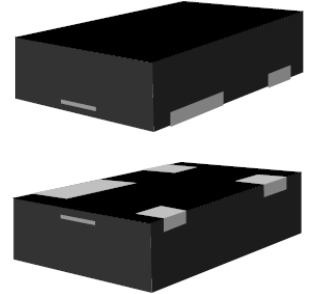

QFN-143

Important: For the latest information, visit our website <http://www.microsemi.com>.

FEATURES

- Protects 1 bidirectional line
- Surge protection per IEC 61000-4-2 and IEC 61000-4-4
- Ultra low capacitance
- Low profile surface mount package
- RoHS compliant versions are available

Also available:

**Unidirectional
(QFN-143)**

 [USBQNM50403e3 –
USBQNM50424e3](#)

APPLICATIONS / BENEFITS

- EIA RS485 data rates: 5 Mbps
- 10 Base-T Ethernet
- USB data rate 900 Mbps
- Non-magnetic for MRI applications

MAXIMUM RATINGS @ 25 °C unless otherwise noted

Parameters/Test Conditions	Symbol	Value	Unit
Storage Temperature	T _{STG}	-55 to +150	°C
Junction Temperature	T _J	-55 to +125	°C
Peak Pulse Power Dissipation with a 10/1000 μ s waveform (with a duty factor of 0.01%)	P _{PP}	500	W
Solder Temperature @ 10 s		260	°C

MSC – Lawrence

6 Lake Street,
Lawrence, MA 01841
1-800-446-1158 or
(978) 620-2600
Fax: (978) 689-0803

MSC – Ireland

Gort Road Business Park,
Ennis, Co. Clare, Ireland
Tel: +353 (0) 65 6840044
Fax: +353 (0) 65 6822298

Website:

www.microsemi.com

MECHANICAL and PACKAGING

- CASE: Void-free transfer molded thermosetting epoxy body meeting UL94V-0.
- TERMINALS: RoHS compliant annealed matte-tin plating over EFTEC64T non-magnetic copper alloy. Readily solderable per MIL-STD-750, method 2026.
- MARKING: Body marked with part number code (NxxC).
- POLARITY: Dot in corner indicates pin 1.
- TAPE-AND-REEL: Standard per EIA-481-B (add "TR" suffix to part number). Consult factory for quantities.
- WEIGHT: Approximately 16.53 milligrams
- See [Package Dimensions](#) on last page.

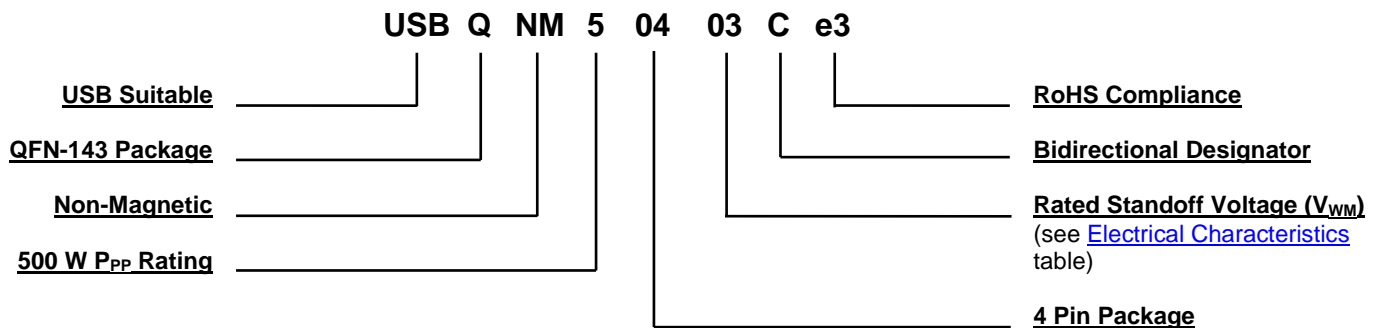
PART NOMENCLATURE

SYMBOLS & DEFINITIONS

Symbol	Definition
$\alpha_{V(BR)}$	Temperature Coefficient of Breakdown Voltage: The change in breakdown voltage divided by the change in temperature that caused it expressed in %/°C or mV/°C.
$I_{(BR)}$	Breakdown Current: The current used for measuring breakdown voltage $V_{(BR)}$.
I_D	Standby Current: The current through the device at rated stand-off voltage.
I_{PP}	Peak Impulse Current: The maximum rated random recurring peak impulse current or nonrepetitive peak impulse current that may be applied to a device. A random recurring or nonrepetitive transient current is usually due to an external cause, and it is assumed that its effect will have completely disappeared before the next transient arrives.
$V_{(BR)}$	Breakdown Voltage: The voltage across the device at a specified current $I_{(BR)}$ in the breakdown region.
V_C	Clamping Voltage: The voltage across the device in a region of low differential resistance during the application of an impulse current (I_{PP}) for a specified waveform.
V_{WM}	Working Standoff Voltage: The maximum-rated value of dc or repetitive peak positive cathode-to-anode voltage that may be continuously applied over the standard operating temperature.

ELECTRICAL CHARACTERISTICS @ 25 °C unless otherwise stated

PART NUMBER	DEVICE MARKING	STAND-OFF VOLTAGE	BREAKDOWN VOLTAGE	CLAMPING VOLTAGE	CLAMPING VOLTAGE	STANDBY CURRENT	CAPACITANCE	TEMPERATURE COEFFICIENT
		V_{WM}	$V_{(BR)}$ @ 1 mA	V_C @ 1 Amp (Figure 2)	V_C @ 5 Amp (Figure 2)	I_D @ V_{WM}	(f= 1 MHz) C @ 0 V	OF $V_{(BR)}$ $\alpha_{V(BR)}$
		Volts	Volts	Volts	Volts	μA	pF	mV/°C
		MAX	MIN	MAX	MAX	MAX	MAX	MAX
USBQNM50403Ce3	N03CE	3.3	4.0	8.0	11	200	3	-5
USBQNM50405Ce3	N05CE	5.0	6.0	10.8	12	40	3	1
USBQNM50412Ce3	N12CE	12.0	13.3	19.0	26	1	3	8
USBQNM50415Ce3	N15CE	15.0	16.7	24.0	32	1	3	11
USBQNM50424Ce3	N24CE	24.0	26.7	43.0	57	1	3	28

GRAPHS

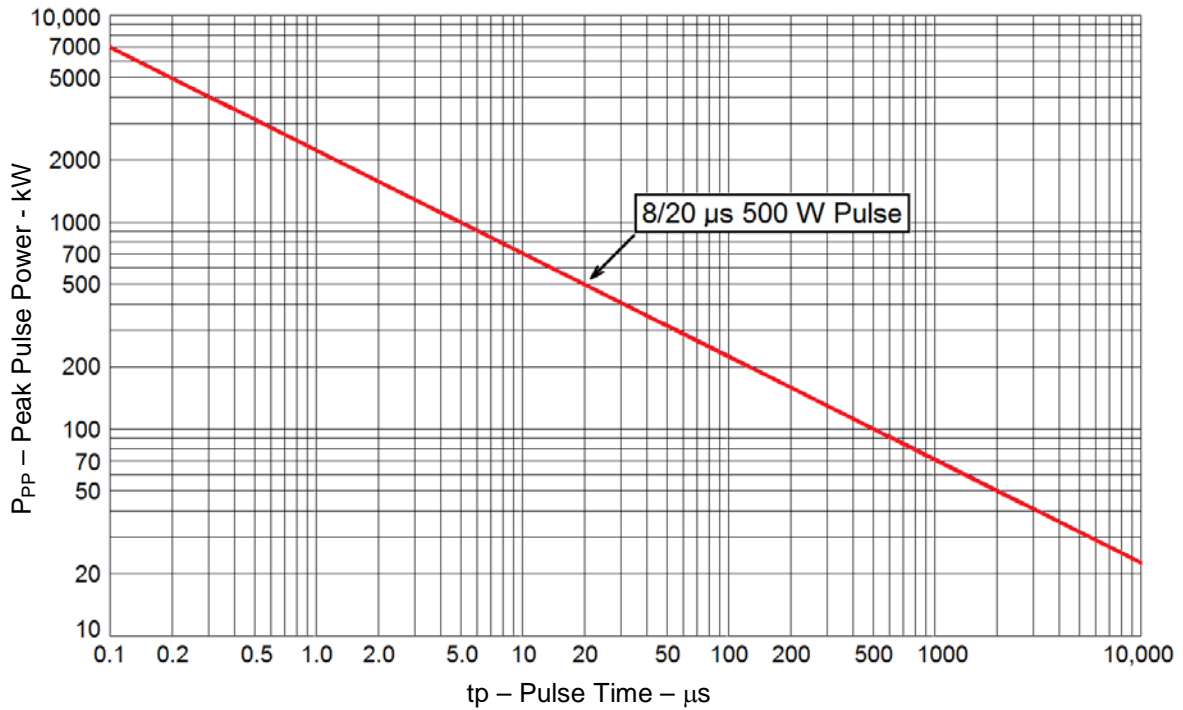

FIGURE 1
Peak Pulse Power vs. Pulse Time

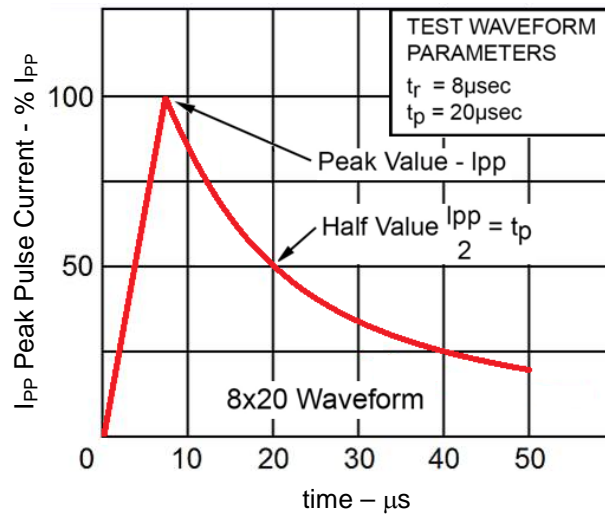
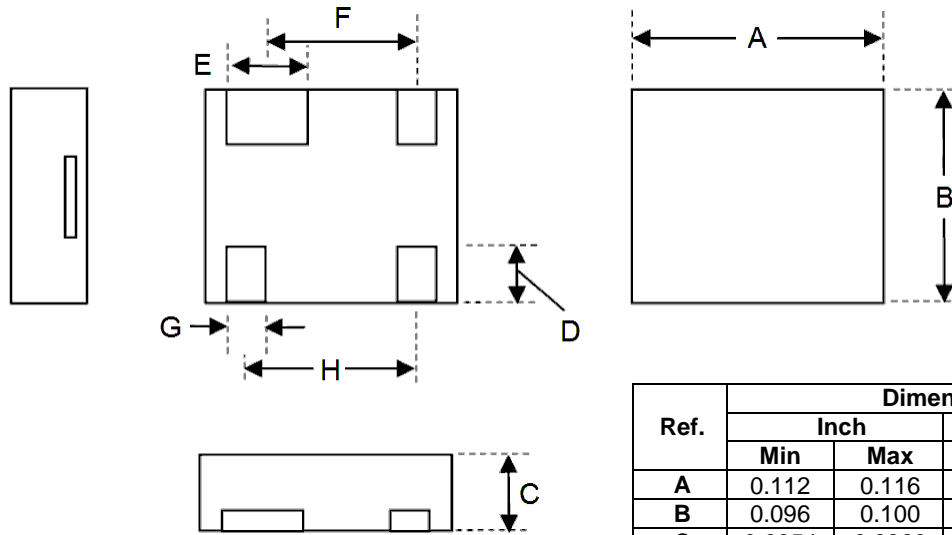
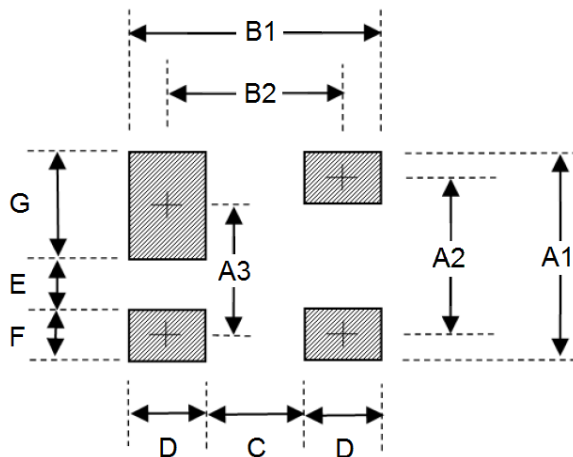

FIGURE 2
Pulse Waveform

PACKAGE DIMENSIONS

Ref.	Dimensions			
	Inch		Millimeters	
	Min	Max	Min	Max
A	0.112	0.116	2.85	2.95
B	0.096	0.100	2.45	2.55
C	0.0354	0.0366	0.900	0.930
D	0.020	0.024	0.50	0.60
E	0.031 NOM		0.80 NOM	
F	0.069 NOM		1.75 NOM	
G	0.018 NOM		0.45 NOM	
H	0.076 NOM		1.92 NOM	

PAD LAYOUT

Ref.	Dimensions	
	Inch	Millimeters
	Nominal	Nominal
A1	0.112	2.85
A2	0.079	2.00
A3	0.071	1.80
B1	0.108	2.75
B2	0.075	1.90
C	0.041	1.05
D	0.033	0.85
E	0.032	0.80
F	0.033	0.85
G	0.047	1.20

See schematic on next page

SCHMATIC

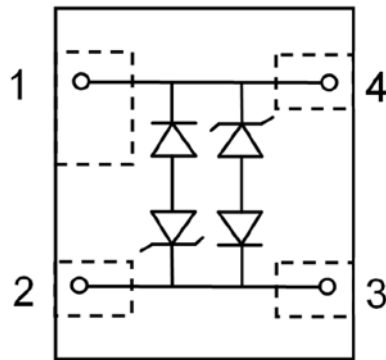

Seen from above

Looking for pricing, stock, or lifecycle information?

Click below to explore more details on WIN SOURCE:

 [View USBQNM50405CE3/TR7 on WIN SOURCE](#)

 [Microchip Technology](#) Information

Optimize Your Supply Chain with WIN SOURCE Solutions

-  Global Sourcing Solution
-  Obsolete Management
-  Cost Control Management
-  Shortage Management
-  Alternative Solution
-  Excess Inventory Management