



THE DATASHEET OF SI8922BB-IS





SKYWORKS®

DATA SHEET

Si8921 and Si8922 Isolated Amplifiers for Current Shunt Measurement

Applications

- Industrial, HEV and renewable energy inverters
- AC, brushless, and DC motor controls and drives
- Variable speed motor control in consumer white goods
- Isolated switch mode and UPS power supplies
- Automotive on-board chargers, battery management systems, and charging stations

Features

- Low-voltage differential input: ± 62.5 mV and ± 250 mV options
- Low signal delay: 0.8 μ s
- Typical input offset: ± 0.40 μ V
- Typical gain error: $\pm 0.06\%$
- Excellent drift specifications
 - 0.5 μ V/ $^{\circ}$ C offset drift
 - -9 ppm/ $^{\circ}$ C typical gain drift
- Typical nonlinearity: 0.003% full-scale
- Typical SNR: 82 dB over 100 kHz bandwidth
- Typical THD: -88 dB
- High common-mode transient immunity: 75 kV/ μ s
- Automotive-grade OPNs available
 - AEC-Q100 qualification
 - AIAG-compliant PPAP documentation support
 - IMDS and CAMDS listing support
- Compact packages
 - 8-pin wide body stretched SOIC
 - 8-pin narrow body SOIC
- -40 to 125 $^{\circ}$ C

Safety Approvals

- UL 1577 recognized
 - Up to 5000 kV_{RMS} for 1 minute
- CSA certification conformity
 - 62368-1 (reinforced insulation)
- VDE certification conformity (pending)
 - 60747-17 (reinforced insulation)
- CQC certification approval
 - GB4943.1

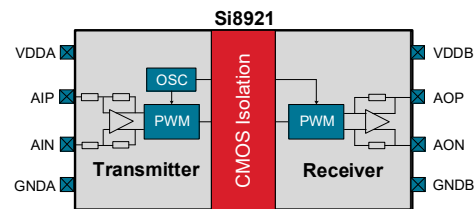

Figure 1. Si8921 Block Diagram

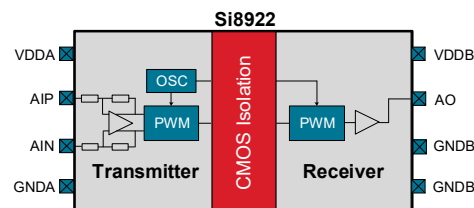

Figure 2. Si8922 Block Diagram

Description

The Si8921 and Si8922 galvanically isolated analog amplifiers feature low-voltage differential input, ideal for measuring voltage across a current shunt resistor or any place where a sensor must be isolated from the control system. The output is a differential analog signal amplified by either 8.2x or 32.8x.

The very low signal delay of the Si8921/22 allows control systems to respond quickly to fault conditions or changes in load. Low offset and gain drift ensure that accuracy is maintained over the entire operating temperature range. Exceptionally high common-mode transient immunity means the Si8921/22 delivers accurate measurements even in the presence of high-power switching as found in motor drive systems and inverters.

The Si8921/22 isolated voltage sensing amplifier utilizes Skyworks proprietary isolation technology, and withstands up to 5.0 kV_{RMS} per UL1577. This technology enables high performance, reduced variation with temperature and age, tighter part-to-part matching, and longer lifetimes compared to other isolation technologies. Automotive Grade is available for certain part numbers. These products are built using automotive-specific flows at all steps in the manufacturing process to ensure the robustness and low defectivity required for automotive applications.



Skyworks Green™ products are compliant with all applicable legislation and are halogen-free. For additional information, refer to *Skyworks Definition of Green™*, document number SQ04-0074.

1. Pin Descriptions

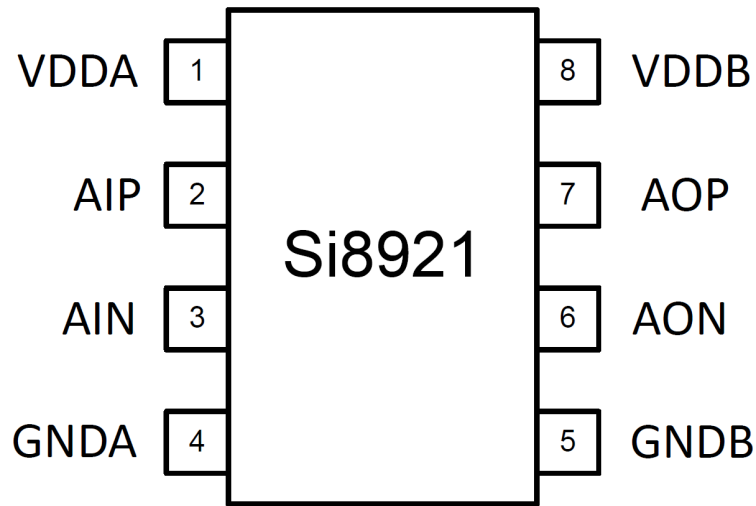

Figure 3. Si8921 Pinout (Top View)

Table 1. Si8921 Pin Descriptions

Name	Pin Number	Description
VDDA	1	Input side power supply
AIP	2	Analog input high
AIN	3	Analog input low
GNDA	4	Input side ground
GNDB	5	Output side ground
AON	6	Analog output low
AOP	7	Analog output high
VDDB	8	Output side power supply

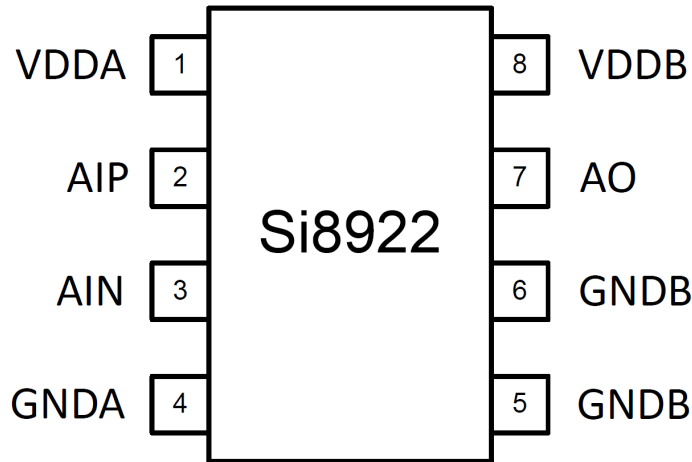

Figure 4. Si8922 Pinout (Top View)

Table 2. Si8922 Pin Descriptions

Name	Pin Number	Description
VDDA	1	Input side power supply
AIP	2	Analog input high
AIN	3	Analog input low
GNDA	4	Input side ground
GNDB ¹	5	Output side ground
GNDB ¹	6	Output side ground
AO	7	Analog output
VDDB	8	Output side power supply

1. Both pin 5 and pin 6 must be connected to ground.

2. Technical Description

The input to the Si8921/22 is designed for low-voltage, differential signals. This is ideal for connection to low resistance current shunt measurement resistors.

The Si8921A has a specified full scale input range of ± 62.5 mV, and the Si8921B has a specified full scale input range of ± 250 mV. In both cases, the internal gain is set so the full scale output is 2.05 V. The Si8921 provides a differential output voltage while the Si8922 provides a single-ended output voltage.

The Si8921/22 modulates the analog signal in a unique way for transmission across the semiconductor based isolation barrier. The input signal is first converted to a pulse-width modulated digital signal.

On the other side of the isolation barrier, the signal is demodulated. The resulting PWM signal is then used to faithfully reproduce the analog signal. This solution provides exceptional signal bandwidth and accuracy.

3. Fail-Safe and Low-Power Modes

The Si8921/22 implements a fail-safe output when the high voltage side supply voltage (VDDA) goes away. This is important for safe operation in systems with high safety requirements. The fail-safe output is nominally 2.8 V (Si8922) or -2.8 V (Si8921) which can be differentiated from the maximum clipping output voltage of 2.6 V to simplify diagnostics on the system level.

Table 3. Si8921 and Si8922 Output Voltages

Device	Output Voltage (VDDA Normal)	Output Voltage (VDDA Removed)
Si8921	$\sim \pm 2.6$ V	~ -2.8 V
Si8922	0 to ~ 2.6 V	$\sim +2.8$ V

In addition to the fail-safe output, when a loss of VDDA supply occurs, the part will automatically move into a lower power mode that reduces IDDB current to approximately 1 mA. Similarly, a loss of VDDB supply will reduce IDDA current to approximately 1 mA. When the supply voltage is returned, normal operation begins in approximately 250 μ s.

4. Current Sense Application

In the driver circuit presented below, the Si8921 is used to amplify the voltage across the sense resistor, RSENSE, and transmit the analog signal to the low-voltage domain across an isolation barrier. Isolation is needed because the voltage of RSENSE with respect to ground will swing between 0 V and the high voltage rail connected to the drain of Q1.

The load in this application can be a motor winding or a similar inductive winding. In a three-phase motor drive application, this circuit would be repeated three times, one for each phase. RSENSE should be a small resistor value to reduce power loss. However, an excessively low resistance will reduce the signal-to-noise ratio of the measurement. Si8921/22 offers two specified full-scale input options, ± 62.5 mV (Si8921A/22A) and ± 250 mV (Si8921B/22B), for optimizing the value of RSENSE.

AIP and AIN connections to the RSENSE resistor should be made as close as possible to each end of the RSENSE resistor as trace resistance will add error to the measurement. The input to the Si8921/22 is differential, and the

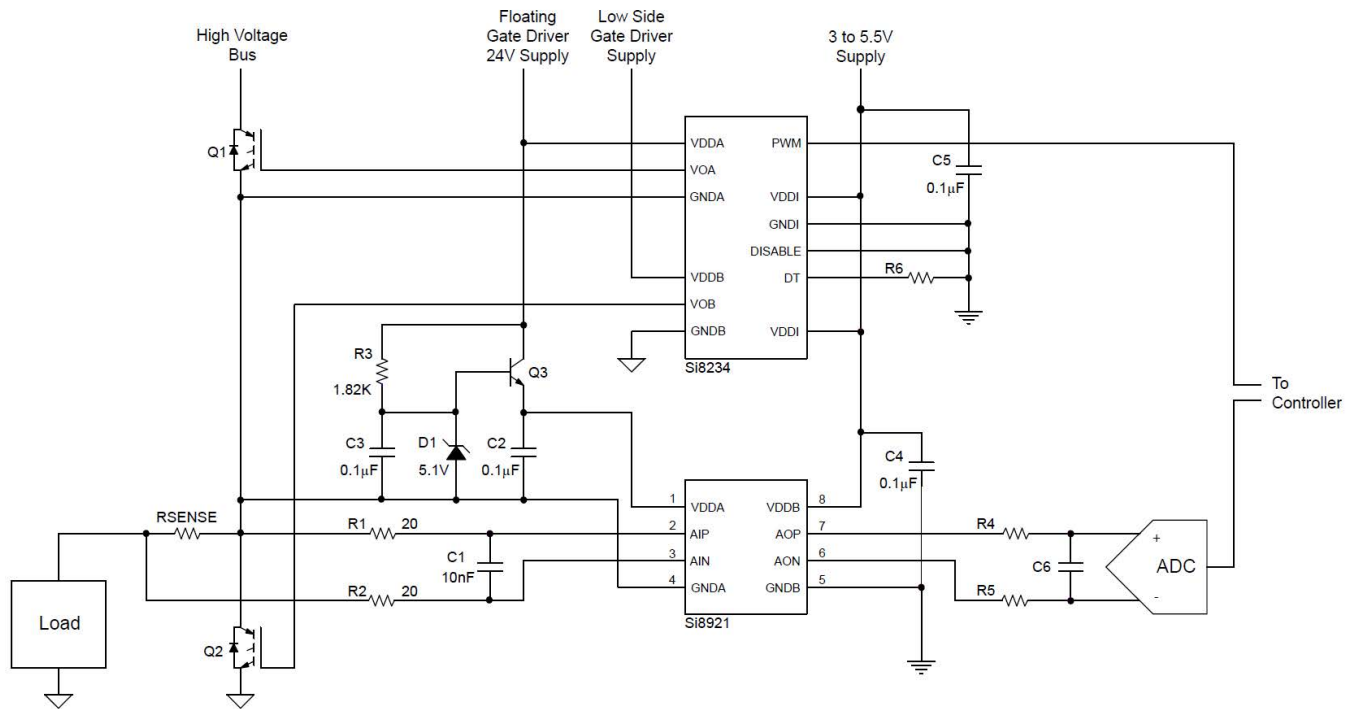

Figure 5. Current Sense Application

PCB traces back to the input pins should run in parallel. This ensures that any large noise transients that occur on the high-voltage side are coupled equally to the AIP and AIN pins and will be rejected by the Si8921/22 as a common-mode signal.

The amplifier bandwidth of the Si8921/22 is approximately 600 kHz. If further input filtering is required, a passive differential RC low-pass filter can be placed between RSENSE and the input pins.

As shown in Figure 5, values of $R1 = R2 = 20 \Omega$ and $C1 = 10 \text{ nF}$ provide a cutoff at approximately 400 kHz. For the lowest gain error, R1 and R2 should always be less than 33Ω to keep the source impedance sufficiently low compared to the Si8921/22 input impedance.

The common-mode voltage of AIN and AIP must be greater than -0.2 V but less than 1 V with respect to GNDA. To meet this requirement, connect GNDA of the Si8921/22 to one side of the RSENSE resistor. In this example, GNDA, RSENSE, the source of Q1, and the drain of Q2 are connected. The ground of the gate driver (Skyworks Si8234 in this circuit) is also commonly connected to the same node.

The Q1 gate driver has a floating supply, 24 V in this example. Since the input and output of the Si8921/22 are galvanically isolated from each other, separate power supplies are necessary on each side. Q3, R3, C3, and D1 make a regulator circuit for powering the input side of the Si8921/22 from this floating supply. D1 establishes a voltage of 5.6 V at the base of Q3. R3 is selected to provide a Zener current of 10 mA for D1. C3 provides filtering at the base of Q3, and the emitter output of Q3 provides approximately 5 V to VDDA. C2 is a bypass capacitor for the supply and should be placed at the VDDA pin with its return trace connecting to the GNDA connection at RSENSE.

C4, the local bypass capacitor for the B-side of Si8921/22, should be placed close to the VDDB supply pin with its return close to GNDB. The output signal at AOP and AON is differential with a nominal gain of 8.2 (Si8921B) or 34.8 (Si8921A) and common mode of 1.4 V.

The outputs are sampled by a differential input ADC. Depending on the sample rate of the ADC, an anti-aliasing filter may be required. A simple anti-aliasing filter can be made from the passive components, R4, C6, and R5. (For the Si8922, Pin 6 and C6 are both grounded, and R5 is removed.)

The characteristics of this filter are dictated by the input topology and sampling frequency of the ADC. However, to ensure the Si8921 outputs are not overloaded, $R4 = R5 > 5 \text{ k}\Omega$ and C6 can be calculated by the equation:

$$C6 = \frac{1}{2 \times \pi \times (R5 + R6) \times f_{3dB}}$$

5. Electrical and Mechanical Specifications

The absolute maximum ratings of the Si8921 and Si8922 are provided below, followed by electrical specifications, performance graphs, and mechanical specifications.

Table 4. Si8921 and Si8922 Absolute Maximum Ratings¹

Parameter	Symbol	Min	Max	Unit
Storage temperature	T _{STG}	-65	150	°C
Ambient temperature under bias	T _A	-40	125	°C
Junction temperature	T _J		150	°C
Supply voltage	V _{DDA} , V _{DDDB}	-0.5	6.0	V
Input voltage respect to GNDA	V _{AIP} , V _{AIN}	-0.5	V _{DDA} + 0.5	V
Output sink or source current	I _o		5	mA
Total power dissipation	P _T		212	mW
Lead solder temperature (10 s)			260	°C
Human Body Model ESD rating		6000		V
Charged Device Model ESD rating		2000		V

1. Note: Exposure to maximum rating conditions for extended periods may reduce device reliability. Exceeding any of the limits listed here may result in permanent damage to the device.

ESD Handling: Industry-standard ESD handling precautions must be adhered to at all times to avoid damage to this device.

Table 5. Si8921 and Si8922 Electrical Specifications¹

T_A = -40 to +125 °C, typical specs at 25 °C with V_{DDA} = V_{DDDB} = 5 V unless specified differently under Test Condition

Parameter	Symbol	Test Condition	Min	Typ	Max	Units
Input Side Supply Voltage	V _{DDA}		3.0		5.5	V
Input Supply Current	Si8921A/21B	I _{DDA}	V _{DDA} = 3.3 V	4.6	6	mA
	Si8922A/22B	I _{DDA}	V _{DDA} = 3.3 V	4.5	6.1	mA
Output Side Supply Voltage	V _{DDDB}		3.0		5.5	V
Output Supply Current	Si8921A/21B	I _{DDDB}	V _{DDDB} = 3.3 V	3.5	4.5	mA
	Si8922A/22B	I _{DDDB}	V _{DDDB} = 3.3 V	4.3	5.6	mA
Amplifier Bandwidth				600		kHz
Amplifier Input						
Specified Linear Input Range	Si8921A	V _{AIP} – V _{AIN}		-62.5	62.5	mV
	Si8921B			-250	250	mV
	Si8922A	V _{AIP} – V _{AIN}		8	68.5	mV
	Si8922B			30	274	mV

Table 5. Si8921 and Si8922 Electrical Specifications¹ (Continued)
T_A = -40 to +125 °C, typical specs at 25 °C with VDDA = VDDB = 5 V unless specified differently under Test Condition

Parameter		Symbol	Test Condition	Min	Typ	Max	Units
Maximum Input Voltage Before Clipping	Si8921A	VAIP – VAIN			±77		mV
	Si8921B				±310		mV
	Si8922A			0	77		mV
	Si8922B			0	310		mV
Common-Mode Operating Range		VCM	A _{IN} ≠ GNDA	-0.2		1	V
Input Referred Offset	Si8921A/21B	VOS	T _A = 25 °C, A _{IP} = A _{IN} = 0	-0.15	±0.04	0.15	mV
	Si8922A/22B	VOS	T _A = 25 °C, A _O = 0.25 V	-0.35	±0.07	0.35	mV
Input Offset Drift		VOS _T		-0.3	0.5	3	µV/°C
Differential Input impedance	Si8921A/22A	RIN			6.3		kΩ
	Si8921B/22B				21.4		kΩ
Differential Input Impedance Drift		RIN _T			850		ppm/°C
Amplifier Output							
Full-Scale Output		VAOP – VAON			2.5		V _{pk}
Gain	Si8921A/22A				32.8		
	Si8921B/22B				8.2		
Gain Error			T _A = 25 °C	-0.2	±0.06	0.2	%
Gain Error Drift				-24	-9	0	ppm/°C
Output Common Mode Voltage (Si8921)		(VAOP + VAON)/2		1.34	1.39	1.49	V
Nonlinearity	Si8921A		T _A = 25 °C	-0.04	0.01	0.04	%
	Si8921B		T _A = 25 °C	-0.02	0.003	0.02	%
	Si8922A		T _A = 25 °C	-0.08	0.02	0.08	%
	Si8922B		T _A = 25 °C	-0.04	0.01	0.04	%
Nonlinearity Drift				-16		16	ppm/°C
Signal-to-Noise Ratio	Si8921A	SNR	F _{IN} = 10 kHz, BW = 100 kHz	70	77		dB
	Si8921B			75	82		dB
	Si8922A			64	71		dB
	Si8922B			69	76		dB
Signal-to-Noise Ratio	Si8921A	SNR	F _{IN} = 1 kHz, BW = 10 kHz		86		dB
	Si8921B				91		dB
	Si8922A				79		dB
	Si8922B				83		dB
Total Harmonic Distortion	Si8921A	THD	F _{IN} = 1 kHz		-85	-74	dB
	Si8921B	THD	F _{IN} = 1 kHz		-88	-71	dB
	Si8922A	THD	F _{IN} = 1 kHz		-82	-60	dB
	Si8922B	THD	F _{IN} = 1 kHz		-85	-63	dB
Power-Supply Rejection Ratio	PSRR		VDDA at DC		-100		dB
			VDDA at 100 mV and 10 kHz ripple		-100		dB
			VDDB at DC		-100		dB
			VDDB at 100 mV and 10 kHz ripple		-100		dB
Output Resistive Load	Si8921	RLOAD	Between AON and AOP	5			kΩ
	Si8922		Between AO and GND	5			kΩ
Output Capacitive Load		CLOAD	Each pin to ground			100	pF
Timing							
Signal Delay (Si8921)		t _{PD}	50% to 50%		0.8		µs

Table 5. Si8921 and Si8922 Electrical Specifications¹ (Continued)

TA = -40 to +125 °C, typical specs at 25 °C with VDDA = VDDB = 5 V unless specified differently under Test Condition

Parameter	Symbol	Test Condition	Min	Typ	Max	Units
Signal Delay (Si8922)	t_{PD}	50% to 50%		1		μs
Rise Time	t_R	10% to 90%		0.8		μs
Startup Time	$t_{STARTUP}$			250		μs
Common-Mode Transient Immunity ²	CMTI	AIP = AIN = AGND, VCM = 1500 V	50	75		kV/ μs

1. Performance is guaranteed only under the conditions listed in this Table and is not guaranteed over the full operating or storage temperature ranges. Operation at elevated temperatures may reduce reliability of the device.
2. An analog CMTI failure is defined as an output error of more than 100 mV persisting for at least 1 μs .

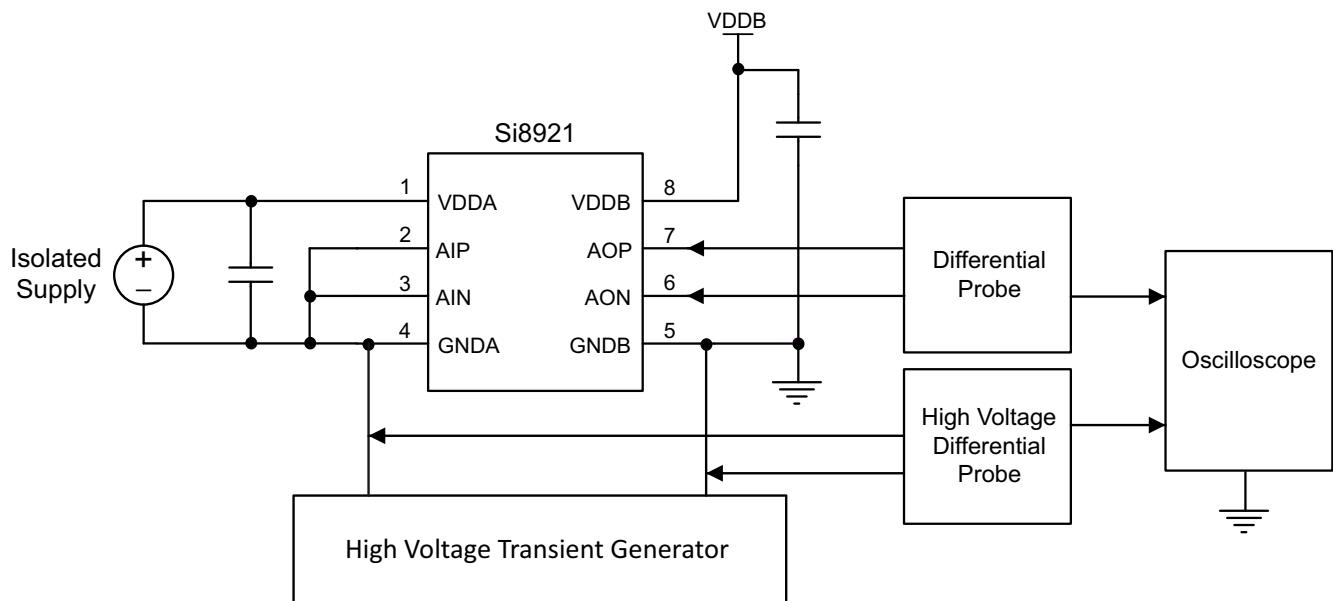

Figure 6. Common-Mode Transient Immunity Characterization Circuit

6. Typical Operating Characteristics

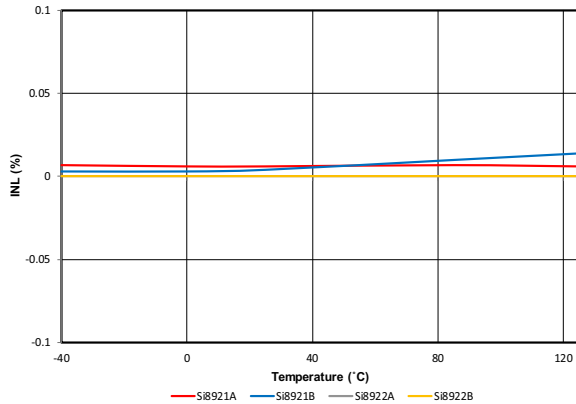

Figure 7. Nonlinearity (%) vs. Temperature (°C)

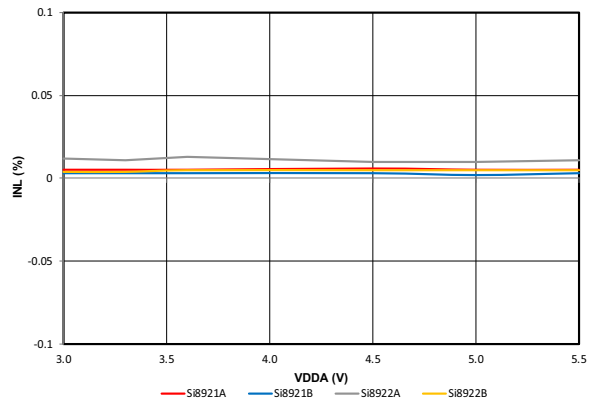

Figure 8. Nonlinearity (%) vs. VDDA Supply (V)

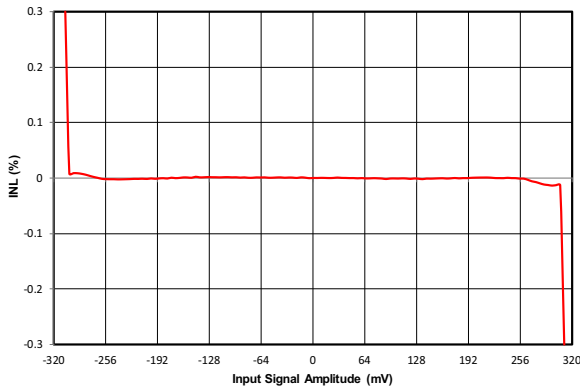

Figure 9. Si8921B Nonlinearity (%) vs. Input Signal Amplitude (mV)

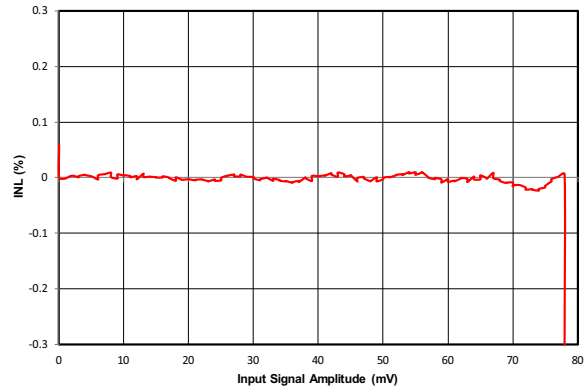

Figure 10. Si8921A Nonlinearity (%) vs. Input Signal Amplitude (mV)

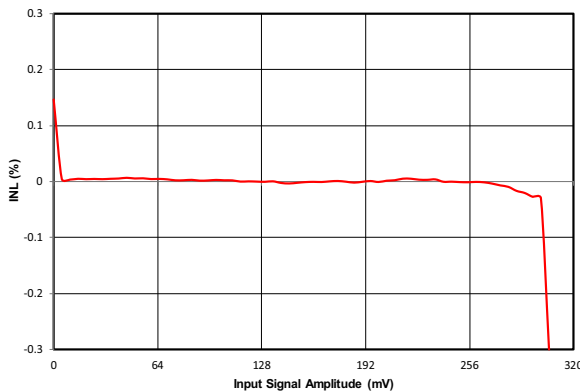

Figure 11. Si8922B Nonlinearity (%) vs. Input Signal Amplitude (mV)

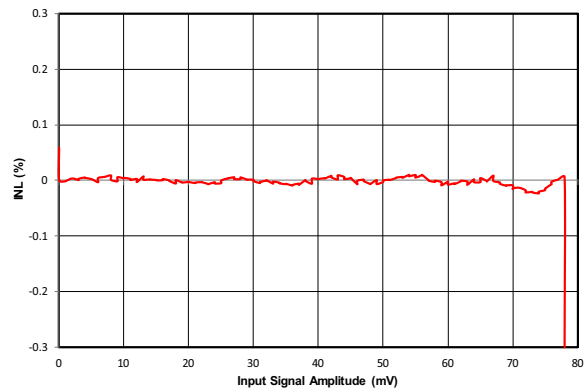

Figure 12. Si8922A Nonlinearity (%) vs. Input Signal Amplitude (mV)

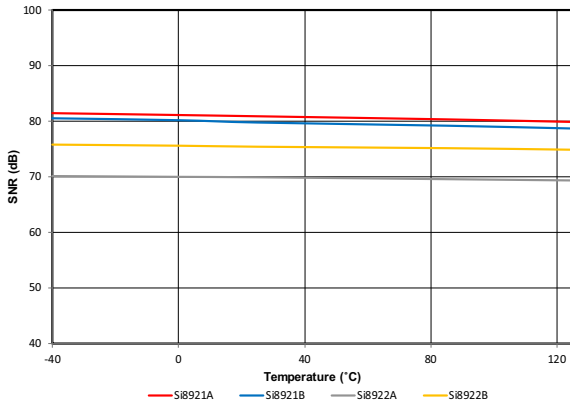

Figure 13. Signal-to-Noise Ratio (dB) vs. Temperature (°C)

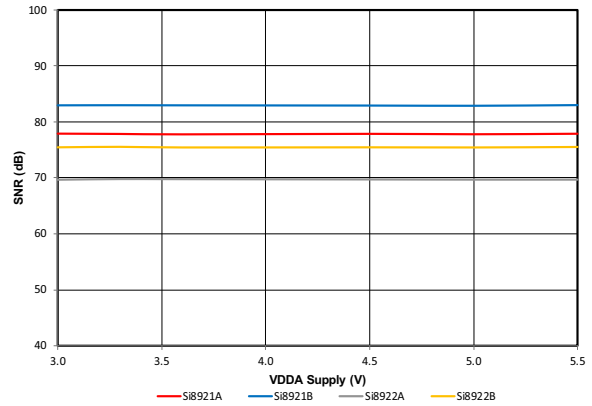

Figure 14. Signal-to-Noise Ratio (dB) vs. VDDA Supply (V)

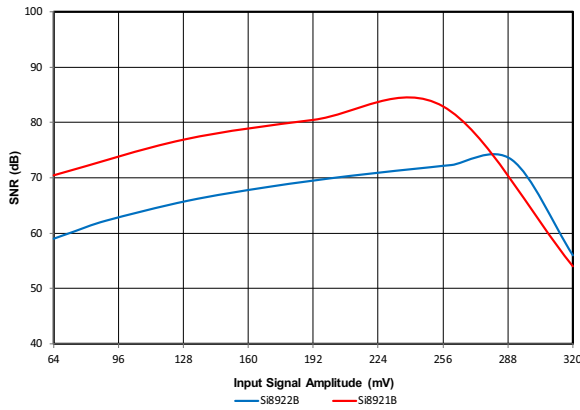

Figure 15. Si892xB Signal-to-Noise Ratio (dB) vs. Input Signal Amplitude (mV)

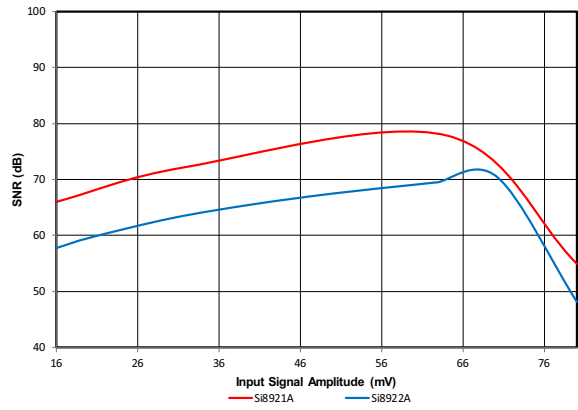

Figure 16. Si892xA Signal-to-Noise Ratio (dB) vs. Input Signal Amplitude (mV)

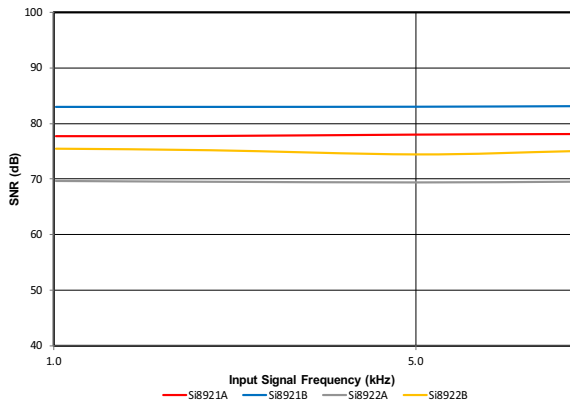

Figure 17. Signal-to-Noise Ratio (dB) vs. Input Signal Frequency (kHz)

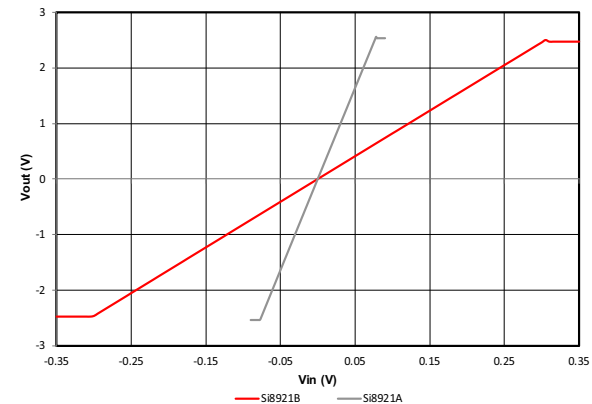

Figure 18. Si8921 Output Voltage (V) vs. Input Voltage (V)

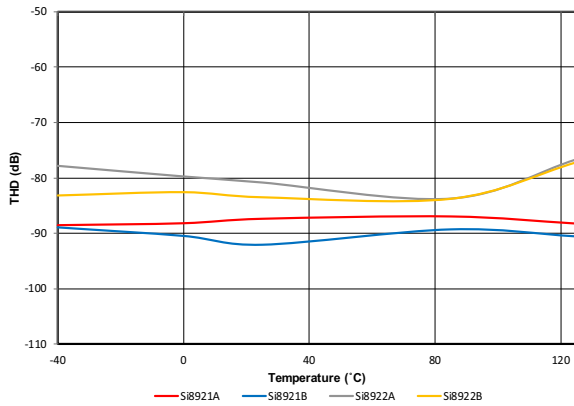

Figure 19. Total Harmonic Distortion (dB) vs. Temperature (°C)

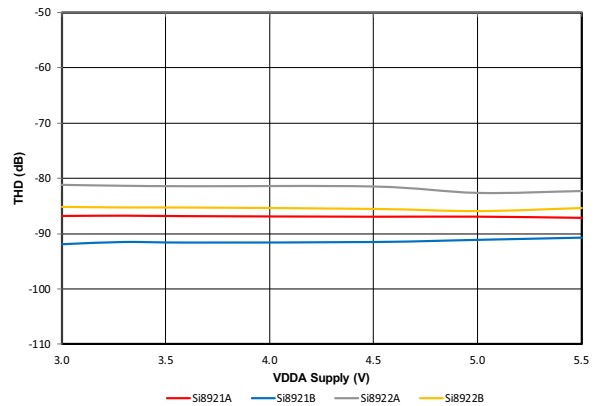

Figure 20. Total Harmonic Distortion (dB) vs. VDDA Supply (V)

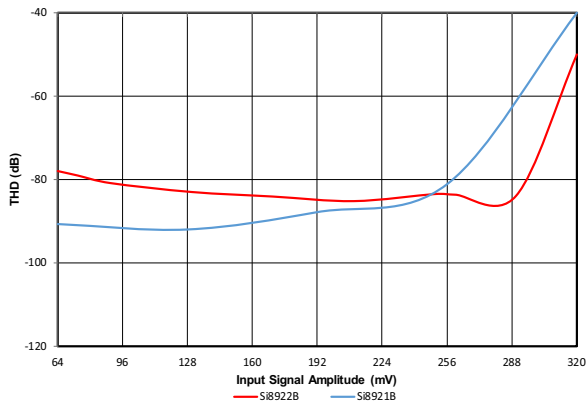

Figure 21. Si892xB Total Harmonic Distortion (dB) vs. Input Signal Amplitude (mV)

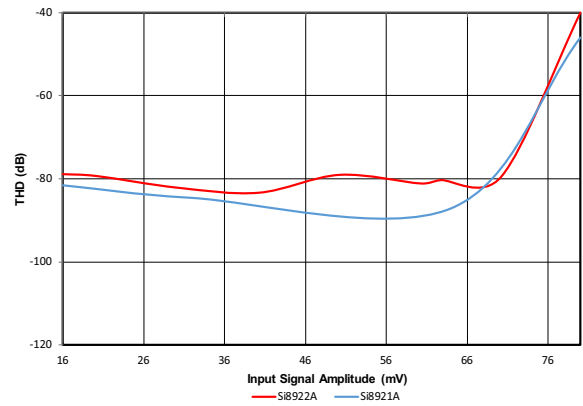

Figure 22. Si892xA Total Harmonic Distortion (dB) vs. Input Signal Amplitude (mV)

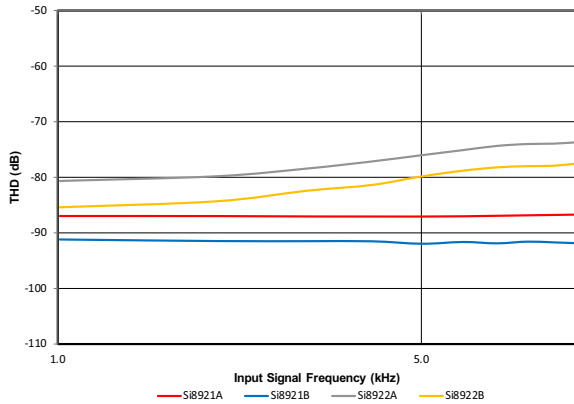

Figure 23. Total Harmonic Distortion (dB) vs. Input Signal Frequency (kHz)

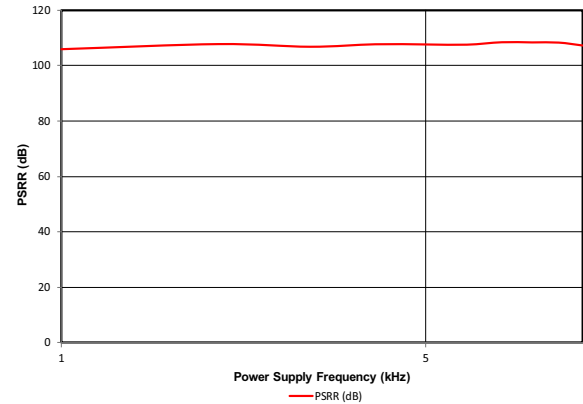

Figure 24. Power Supply Rejection Ratio vs. Power Supply Frequency (kHz)

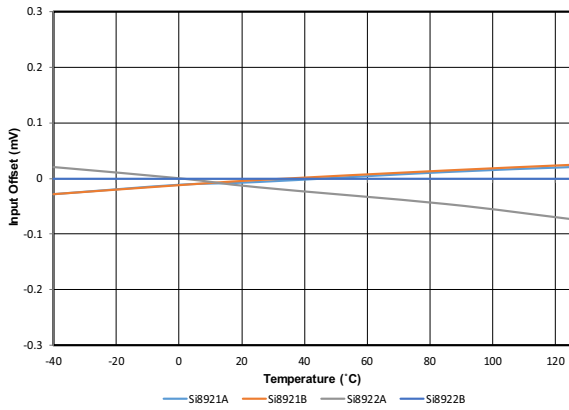

Figure 25. Input Offset (mV) vs. Temperature (°C)

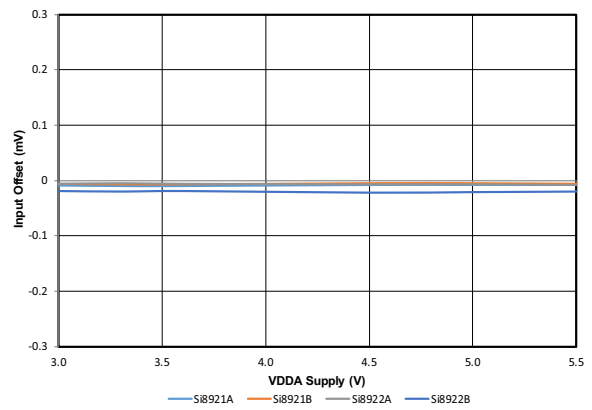

Figure 26. Input Offset (mV) vs. VDDA Supply (V)

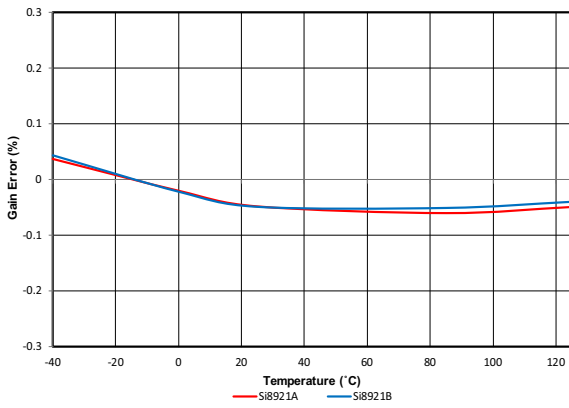

Figure 27. Gain Error (%) vs. Temperature (°C)

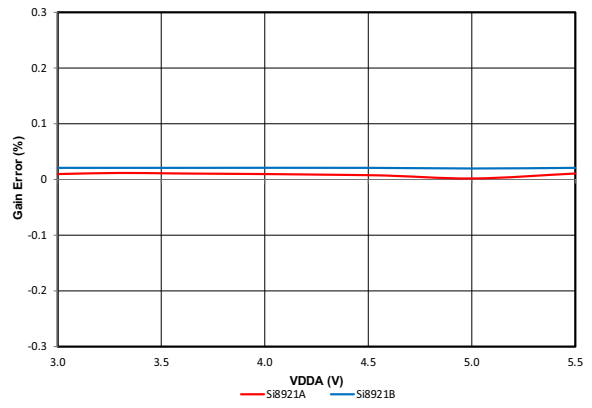

Figure 28. Gain Error (%) vs. VDDA Supply (V)

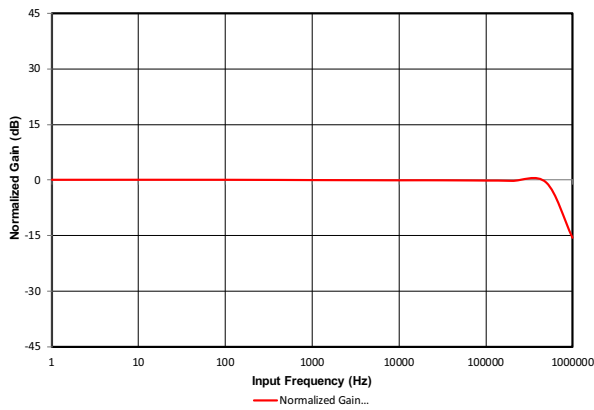

Figure 29. Amplifier Bandwidth

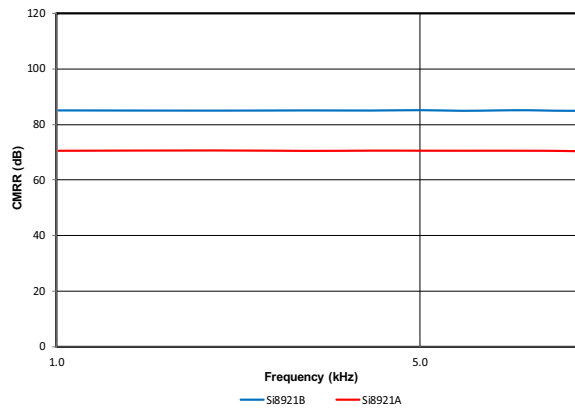

Figure 30. Common-Mode Rejection Ratio (dB) vs. Input Frequency (kHz)

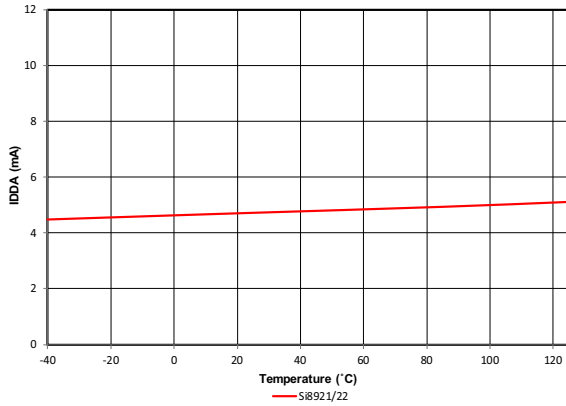

Figure 31. IDDA (mA) vs. Temperature (°C)

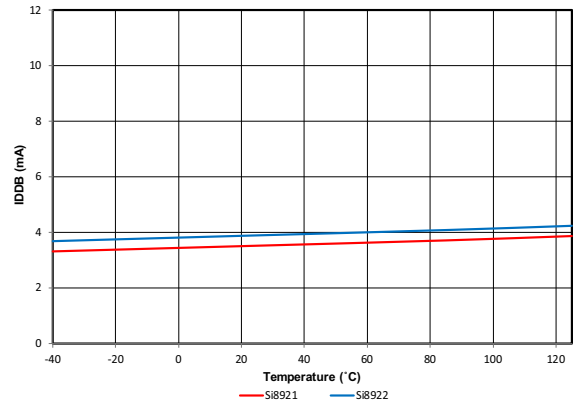

Figure 32. IDDB (mA) vs. Temperature (°C)

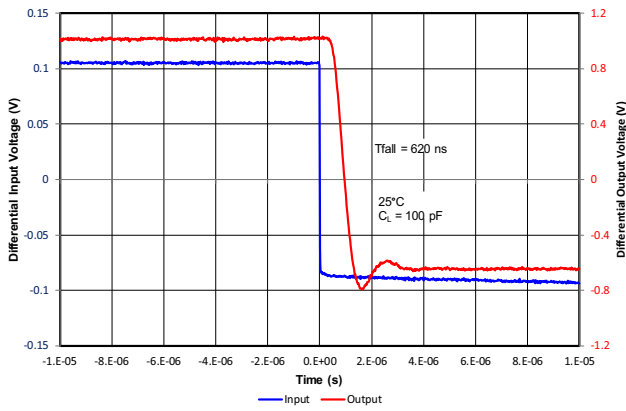

Figure 33. Si8921B High-to-Low Step Response

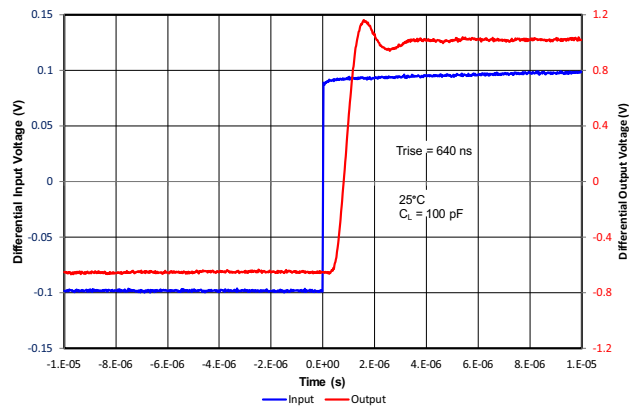

Figure 34. Si8921B Low-to-High Step Response

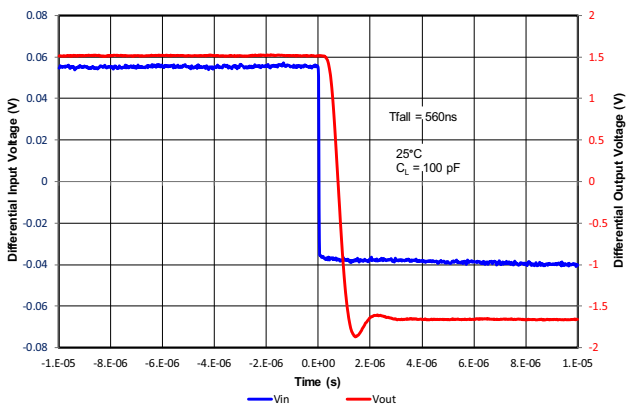

Figure 35. Si8921A High-to-Low Step Response

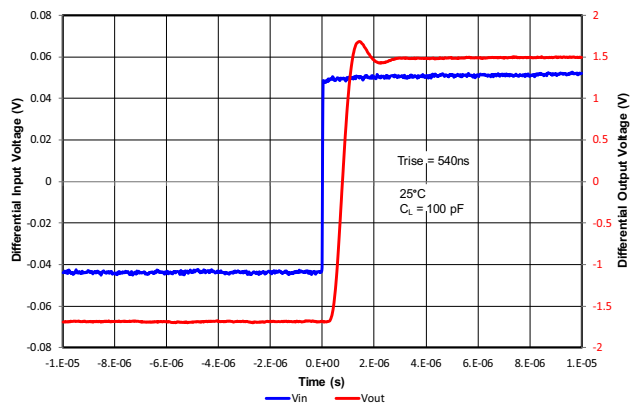

Figure 36. Si8921A Low-to-High Step Response

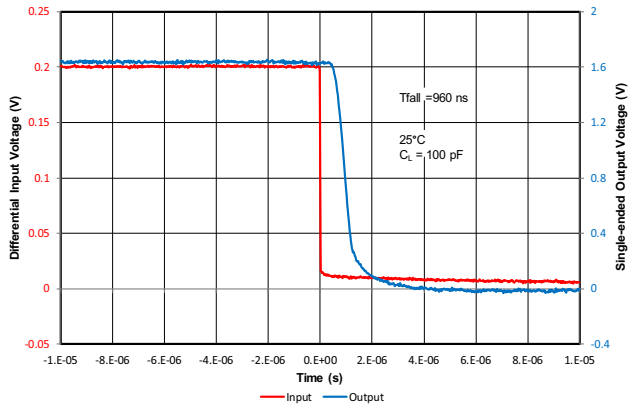

Figure 37. Si8922B High-to-Low Step Response

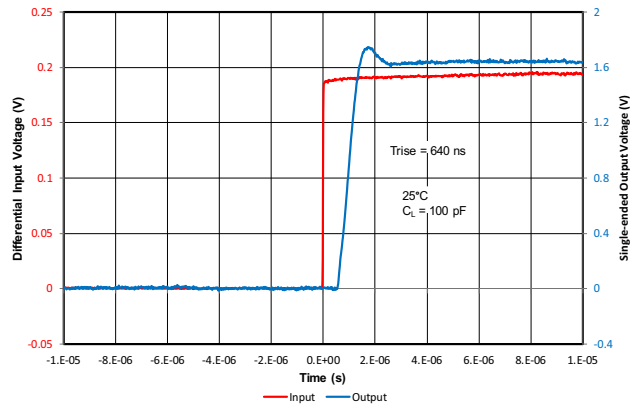

Figure 38. Si8922B Low-to-High Step Response

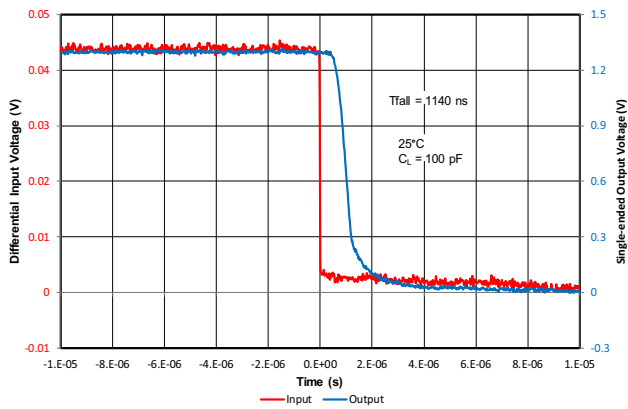

Figure 39. Si8922A High-to-Low Step Response

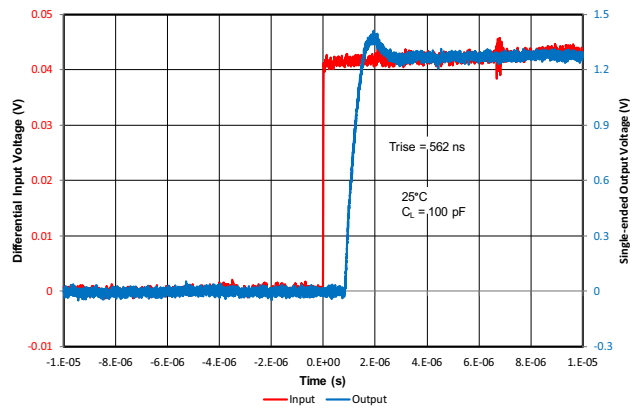

Figure 40. Si8922A Low-to-High Step Response

7. Safety Certifications and Specifications

Table 6. Regulatory Information¹

CSA
The Si8921/Si8922 is certified under CSA. For more details, see Master Contract File 232873.
62368-1: Up to 600 V _{RMS} reinforced insulation working voltage; up to 1000 V _{RMS} basic insulation working voltage.
VDE
The Si8921/Si8922 is certified under VDE. For more details, see File 5028467.
60747-17: Up to 2121 V _{peak} for reinforced insulation working voltage.
UL
The Si8921/Si8922 is certified under UL1577 component recognition program. For more details, see File E257455.
Rated up to 5000 V _{RMS} V _{ISO} isolation voltage for basic protection.
CQC
The Si8921/Si8922 is certified under GB4943.1.
Rated up to 250 V _{RMS} reinforced insulation working voltage at 5000 meters tropical climate.

1. For more information, see Section 12. [Ordering Information](#)

Table 7. Insulation and Safety-Related Specifications

Parameter	Symbol	Test Condition	Value		Unit
			WB Stretched SOIC-8	NB SOIC-8	
Nominal external air gap (clearance)	CLR		8.0	4.0	mm
Nominal external tracking (creepage)	CRP		8.0	4.0	mm
Minimum internal gap (internal clearance)	DTI		0.036	0.036	mm
Tracking resistance	PTI or CTI	IEC60112	600	600	V _{RMS}
Erosion depth	ED		0.04	0.04	mm
Resistance (input-output) ¹	R _{io}	Test voltage = 500 V, 25 °C	10 ¹²	10 ¹²	Ω
Capacitance (input-output) ¹	C _{io}	f = 1 MHz	1	1	pF

1. To determine resistance and capacitance, the Si8921/Si8922 is converted into a two-terminal device. Pins 1 to 4 are shorted together to form the first terminal, and pins 5 to 8 are shorted together to form the second terminal. The parameters are then measured between these two terminals.

Table 8. IEC 60664-1 Ratings

Parameter	Test Conditions	Specification	
		WB Stretched SOIC-8	NB SOIC-8
Material group		I	I
Overvoltage category	Rated mains voltage $\leq 150 V_{RMS}$	I-IV	I-IV
	Rated mains voltage $\leq 300 V_{RMS}$	I-IV	I-III
	Rated mains voltage $\leq 600 V_{RMS}$	I-IV	I-II
	Rated mains voltage $\leq 1000 V_{RMS}$	I-III	I

Table 9. IEC 60747-17 Insulation Characteristics¹

Parameter	Symbol	Test Condition	Characteristic		Unit
			WB Stretched SOIC-8	NB SOIC-8	
Maximum working isolation voltage	V_{IOWM}	According to Time-Dependent Dielectric Breakdown (TDDB) Test	1500	445	V_{RMS}
Maximum repetitive isolation voltage	V_{IORM}	According to Time-Dependent Dielectric Breakdown (TDDB) Test	2121	630	V_{peak}
Apparent charge	q_{pd}	Method b: At routine test (100% production) and preconditioning (type test); $V_{ini} = 1.2 \times V_{IOTM}$, $t_{ini} = 1 s$; $V_{pd(m)} = 1.875 \times V_{IORM}$, $t_m = 1 s$ (method b1) or $V_{pd(m)} = V_{ini}$, $t_m = t_{ini}$ (method b2)	≤ 5	≤ 5	pC
Maximum transient isolation voltage	V_{IOTM}	$V_{TEST} = V_{IOTM}$, $t = 60 s$ (qualification); $V_{TEST} = 1.2 \times V_{IOTM}$, $t = 1 s$ (100% production)	7070	3535	V_{peak}
Maximum surge isolation voltage	V_{IOSM}	Tested in oil with $1.3 \times V_{IMP}$ or 10 kV minimum and $1.2 \mu s/50 \mu s$ profile	10400	10400	V_{peak}
Maximum impulse voltage	V_{IMP}	Tested in air with $1.2 \mu s/50 \mu s$ profile	8000	5000	V_{peak}
Isolation resistance	R_{IO_S}	$T_{AMB} = T_S$, $V_{IO} = 500 V$	$>10^9$	$>10^9$	Ω
Pollution degree			2	2	
Climatic category			40/125/21	40/125/21	

1. This coupler is suitable for “safe electrical insulation” only within the safety ratings. Compliance with the safety ratings shall be ensured by means of suitable protective circuits.

Table 10. UL 1577 Insulation Characteristics

Parameter	Symbol	Test Condition	Characteristic		Unit
			WB Stretched SOIC-8	NB SOIC-8	
Maximum withstanding isolation voltage	V_{ISO}	$V_{TEST} = V_{ISO}$, $t = 60 s$ (qualification); $V_{TEST} = 1.2 \times V_{ISO}$, $t = 1 s$ (100% production)	5000	2500	V_{RMS}

Table 11. IEC 60747-17 Safety Limiting Values¹

Parameter	Symbol	Test Condition	Characteristic	Unit
Safety temperature	T_S		150	°C
Safety input, output or supply current (WB stretched SOIC-8)	I_S	$\theta_{JA} = 90\text{ °C/W}$ $V_{DD} = 5.5\text{ V}$ $T_J = 150\text{ °C}$ $T_A = 25\text{ °C}$	253	mA
		$\theta_{JA} = 90\text{ °C/W}$ $V_{DD} = 3.6\text{ V}$ $T_J = 150\text{ °C}$ $T_A = 25\text{ °C}$	386	mA
Safety input, output or supply current (NB SOIC-8)	I_S	$\theta_{JA} = 112\text{ °C/W}$ $V_{DD} = 5.5\text{ V}$ $T_J = 150\text{ °C}$ $T_A = 25\text{ °C}$	203	mA
		$\theta_{JA} = 112\text{ °C/W}$ $V_{DD} = 3.6\text{ V}$ $T_J = 150\text{ °C}$ $T_A = 25\text{ °C}$	310	mA
Safety input, output or total power (WB stretched SOIC-8)	P_S	$\theta_{JA} = 90\text{ °C/W}$ $T_J = 150\text{ °C}$ $T_A = 25\text{ °C}$	1389	mW
Safety input, output or total power (NB SOIC-8)	P_S	$\theta_{JA} = 112\text{ °C/W}$ $T_J = 150\text{ °C}$ $T_A = 25\text{ °C}$	1116	mW

1. Maximum value allowed in the event of a failure. Refer to the derating curves Figure 41, “WB Stretched SOIC-8 Thermal Derating Curve (Dependence of Safety Limiting Current),” on page 18 and Figure 42, “NB SOIC-8 Thermal Derating Curve (Dependence of Safety Limiting Current),” on page 19.

Table 12. Thermal Characteristics

Parameter	Symbol	WB Stretched SOIC-8	NB SOIC-8	Unit
IC Junction-to-air thermal resistance	θ_{JA}	90	112	°C/W

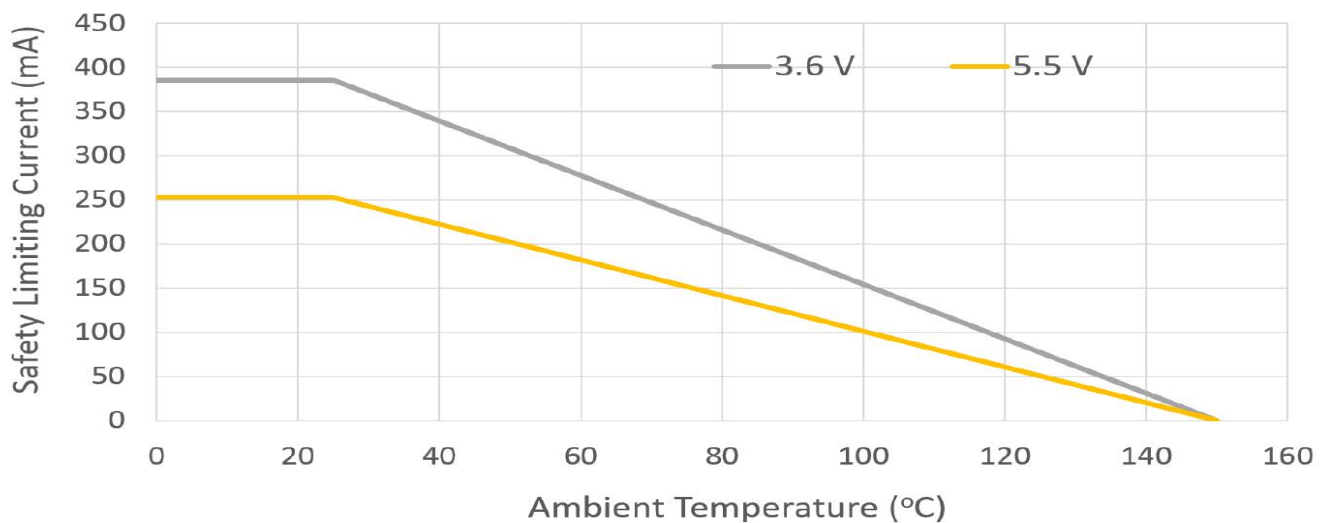

Figure 41. WB Stretched SOIC-8 Thermal Derating Curve (Dependence of Safety Limiting Current)

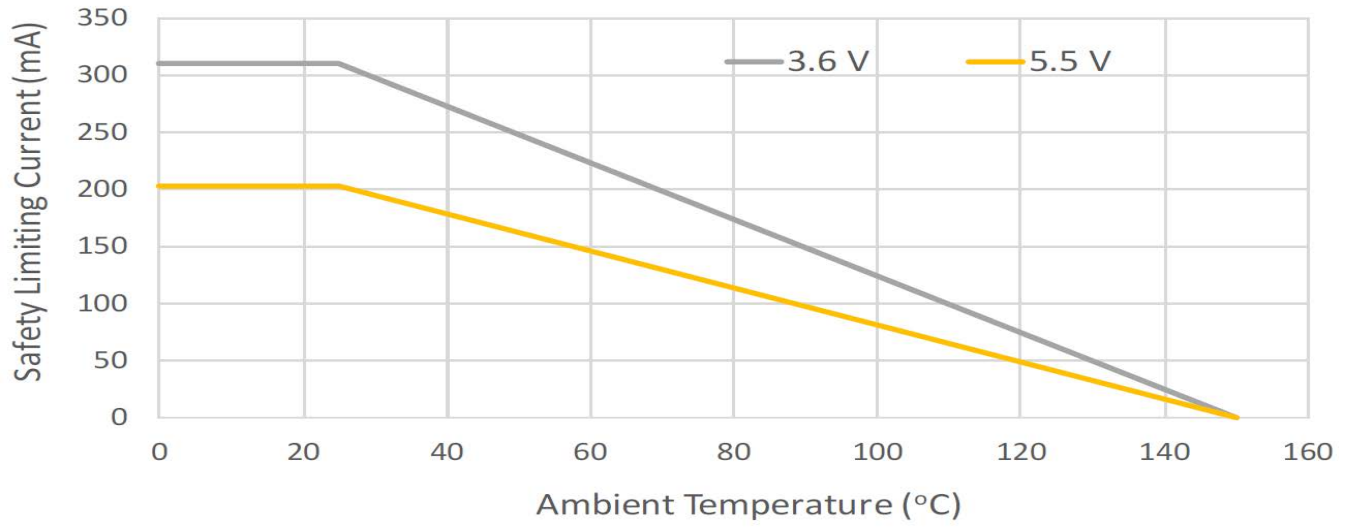

Figure 42. NB SOIC-8 Thermal Derating Curve (Dependence of Safety Limiting Current)

8. Package Handling Information

Since the device package is sensitive to moisture absorption, it is baked and vacuum packed before shipping. Instructions on the shipping container label regarding exposure to moisture after the container seal is broken must be followed. Otherwise, problems related to moisture absorption may occur when the part is subjected to high temperature during solder assembly.

The Si8921 and Si8922 devices with an -IS and -AS suffix are rated to Moisture Sensitivity Level 2 (MSL2) at 260 °C. Devices with an -IS4 and -AS4 suffix are rated to Moisture Sensitivity Level 2A (MSL2A) at 260 °C.

All devices can be used for lead or lead-free soldering. For additional information, refer to Skyworks Application Note, "PCB Design and SMT Assembly/Rework Guidelines," Document Number 101752.

Care must be taken when attaching this product, whether it is done manually or in a production solder reflow environment. Refer to Standard SMT Reflow Profiles: JEDEC Standard J-STD-020.

9. Package Dimensions

9.1. Package Outline, 8-Pin Wide Body Stretched SOIC

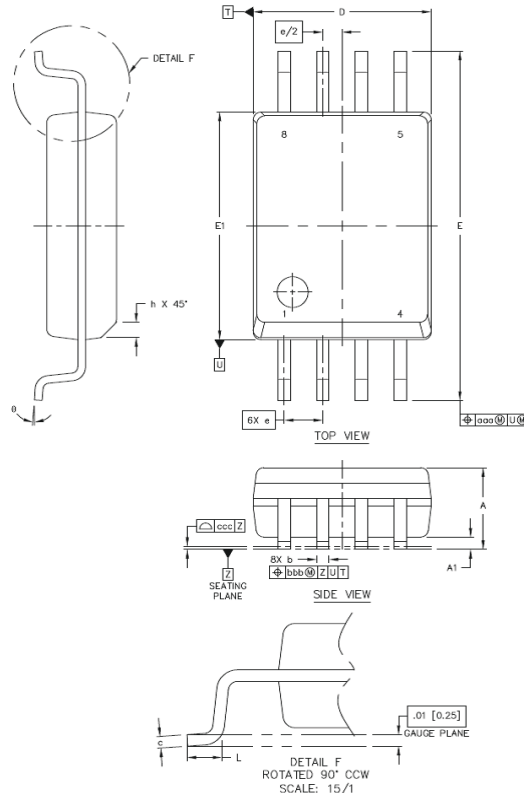

Figure 43. 8-Pin Wide Body Stretched SOIC Package

Table 13. 8-Pin Wide Body Stretched SOIC Package Dimensions

Dimension	Millimeters		Notes
	Min	Max	
A	2.49	2.79	Dimensioning and tolerancing per ANSI Y14.5M-1994. Recommended reflow profile per JEDEC J-STD-020C specification for small body, lead-free components.
A1	0.36	0.46	
b	0.30	0.51	
c	0.20	0.33	
D	5.74	5.94	
E	11.25	11.76	
E1	7.39	7.59	
e	1.27 BSC		
L	0.51	1.02	
h	0.25	0.76	
θ	0°	8°	
aaa		0.25	
bbb		0.25	
ccc		0.10	

9.2. Package Outline, 8-Pin Narrow Body SOIC

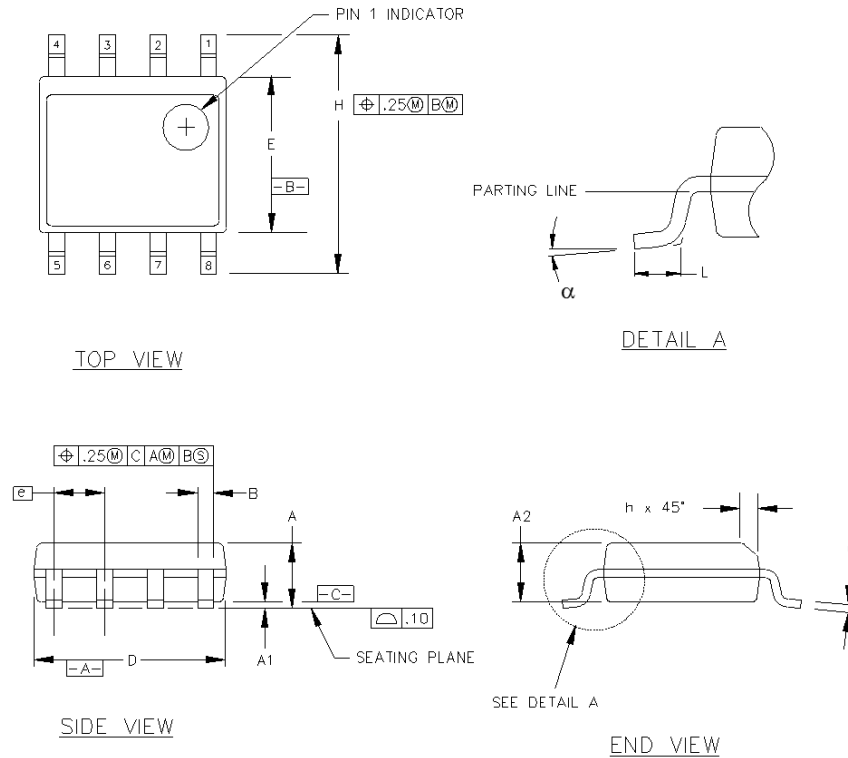

Figure 44. 8-Pin Narrow Body SOIC Package

Table 14. 8-Pin Narrow Body SOIC Package Dimensions

Dimension	Millimeters		Notes
	Min	Max	
A	1.35	1.75	Dimensioning and tolerancing per ANSI Y14.5M-1982. This drawing conforms to JEDEC Outline MS-012. Recommended card reflow profile is per the JEDEC/IPC J-STD-020B specification for small body components.
A1	0.10	0.25	
A2	1.40 REF	1.55 REF	
B	0.33	0.51	
C	0.19	0.25	
D	4.80	5.00	
E	3.80	4.00	
e	1.27 BSC		
H	5.80	6.20	
h	0.25	0.50	
L	0.40	1.27	
α	0°	8°	

9.3. Land Pattern, 8-Pin Wide Body Stretched SOIC

General Guidelines

1. All dimensions shown are at Maximum Material Condition (MMC). Least Material Condition (LMC) is calculated based on a fabrication allowance of 0.05 mm.
2. This land pattern design is based on the IPC-7351 guidelines.

Solder Mask Design

1. All metal pads are to be non-solder mask defined (NSMD).
2. Clearance between the solder mask and the metal pad is to be 60 μm minimum, all the way around the pad.

Stencil Design

1. A stainless steel, laser-cut and electro-polished stencil with trapezoidal walls should be used to assure good solder paste release.
2. The stencil thickness should be 0.125 mm (5 mils).
3. The ratio of stencil aperture to land pad size should be 1:1 for all perimeter pins.

Card Assembly

1. A No-clean, Type-3 solder paste is recommended.
2. The recommended card reflow profile is per the JEDEC/IPC J-STD-020 specification for Small Body Components.

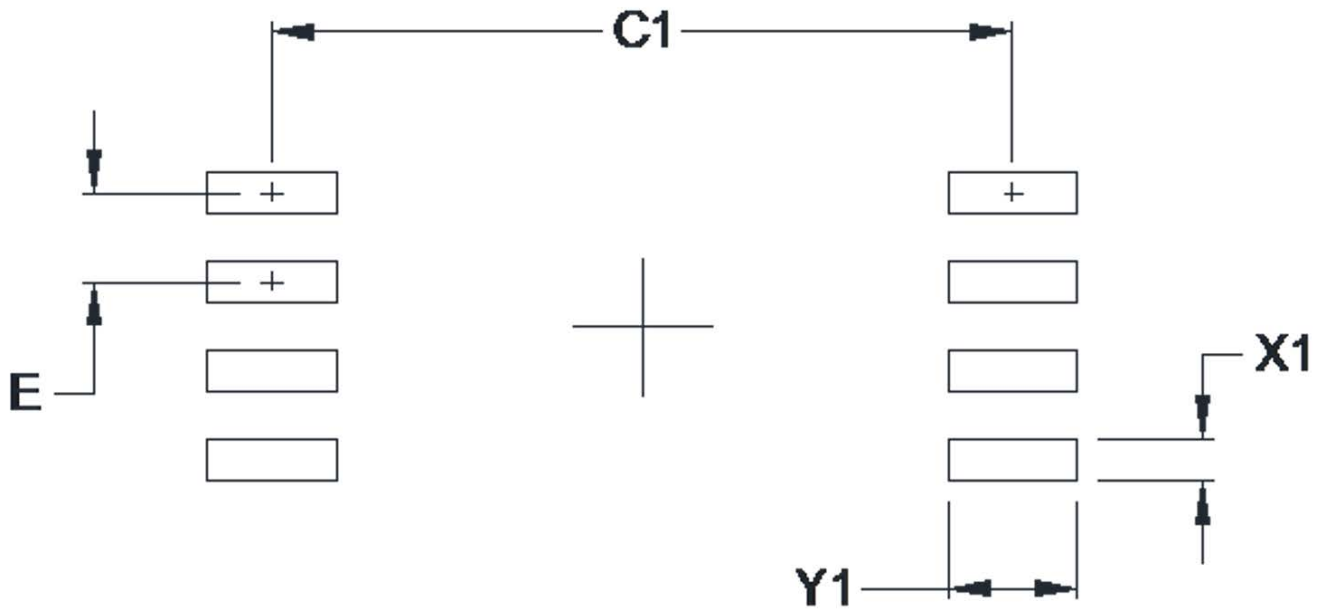

Figure 45. 8-Pin Wide Body Stretched SOIC Land Pattern

Table 15. 8-Pin Wide Body Stretched SOIC Land Pattern Dimensions¹

Dimension	(mm)
C1	10.60
E	1.27
X1	0.60
Y1	1.85

1. See General Guidelines

9.4. Land Pattern:, 8-Pin Narrow Body SOIC

General Guidelines

1. All feature sizes shown are at Maximum Material Condition (MMC) and a card fabrication tolerance of 0.05 mm is assumed.
2. This Land Pattern Design is based on IPC-7351 pattern SOIC127P600X173-8N for Density Level B (Median Land Protrusion).

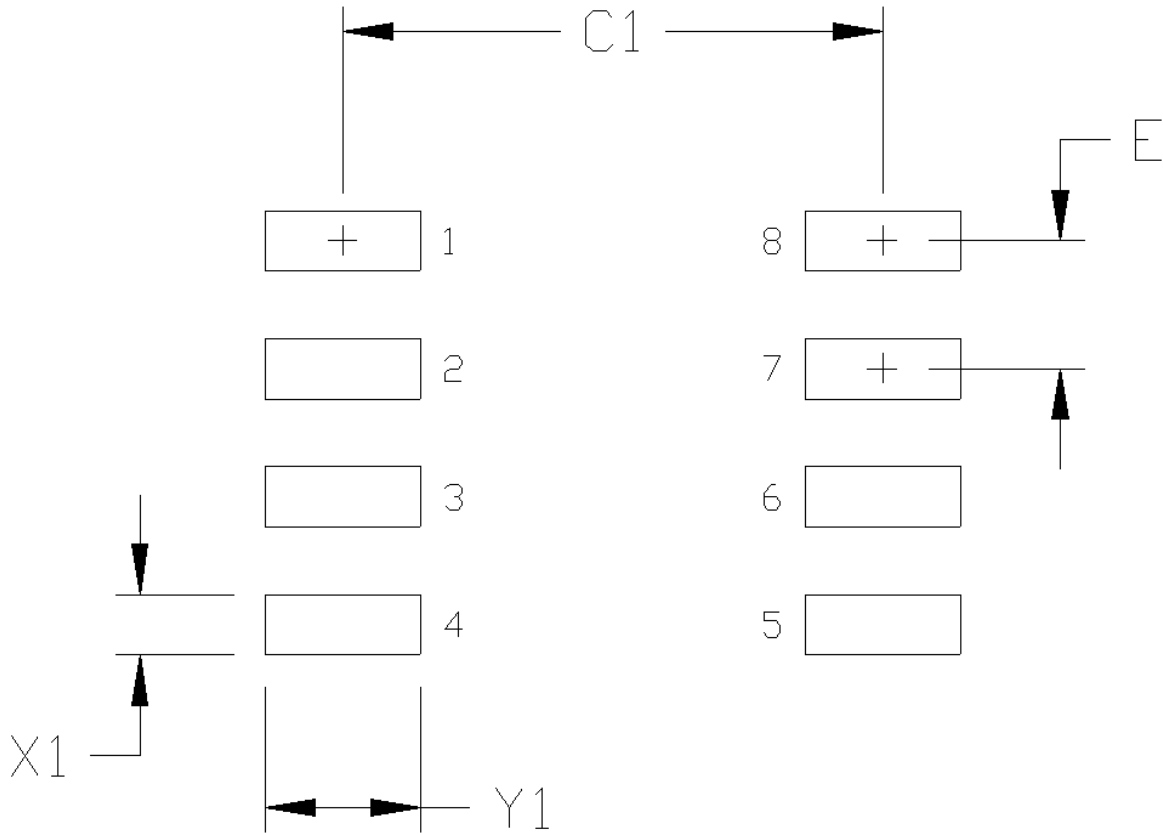

Figure 46. 8-Pin Narrow Body SOIC Land Pattern

Table 16. 8-Pin Narrow Body SOIC Land Pattern Dimensions¹

Dimension	mm
C1	5.40
E	1.27
X1	0.60
Y1	1.55

1. See General Guidelines

10. Package Marking

10.1. Top Marking, 8-Pin Wide Body Stretched SOIC

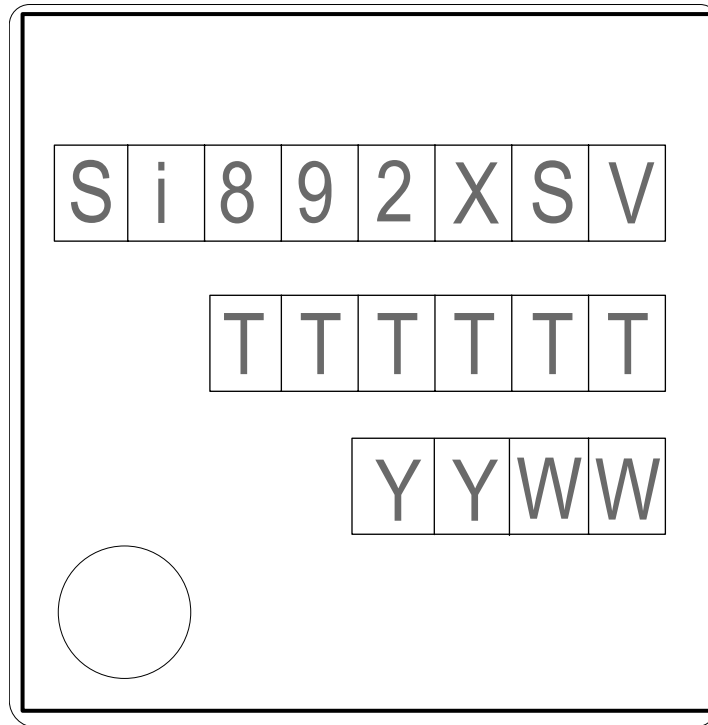

Figure 47. Si8921 Typical Package Marking, 8-Pin Wide Body Stretched SOIC

Table 17: 8-Pin Wide Body Stretched SOIC Top Marking Explanation

Line 1	Part Number	Si892x Isolator Amplifier Series X = Base part number 1 = Differential output 2 = Single-ended output S = Specified linear input range A = ± 62.5 mV for Si8921, 8 to 68.5 mV for Si8922 B = ± 250 mV for Si8921, 30 to 274 mV for Si8922 V = Insulation rating D = 5.0 kV _{RMS}
Line 2	TTTTT	Manufacturing code The first character is a letter in the range N through Z to indicate Automotive Grade
Line 3	YY = Year WW = Work Week Circle = 43 mils diameter left justified	Year and work week

10.2. Top Marking, 8-Pin Narrow Body SOIC

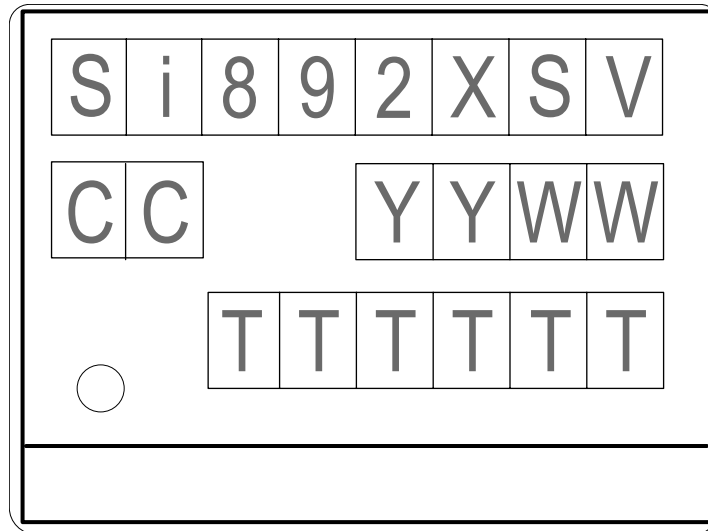
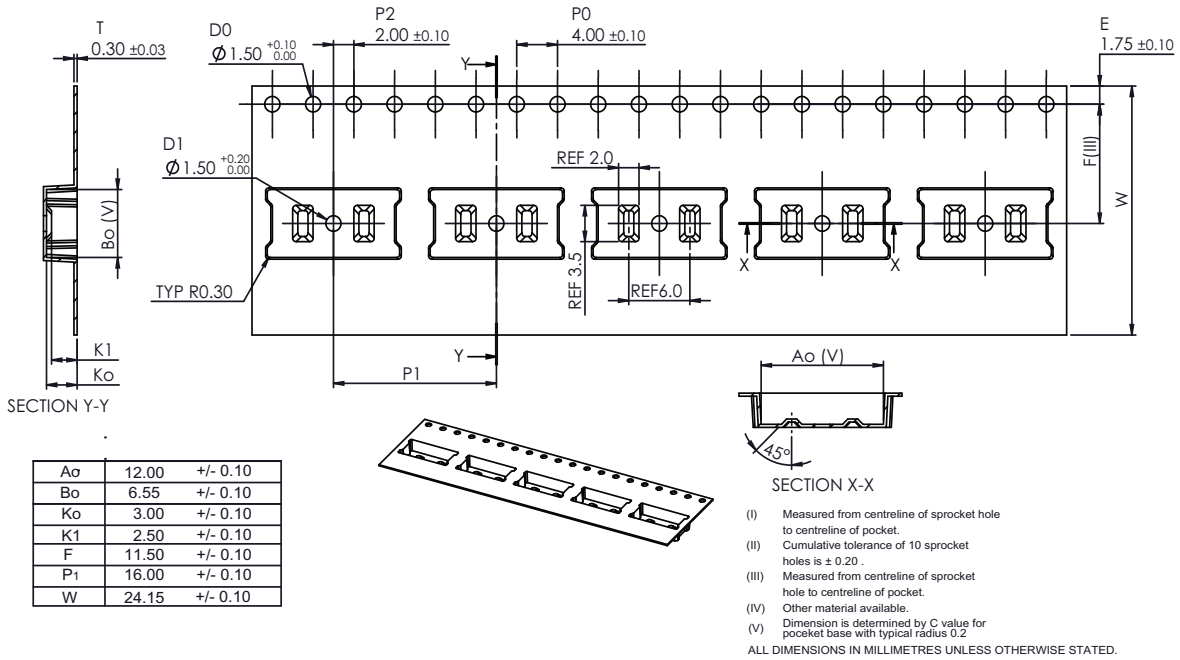

Figure 48. Si8921/22 Typical Package Marking, 8-Pin Narrow Body SOIC

Table 18. 8-Pin Narrow Body SOIC Top Marking Explanation

Line 1	Part Number	Si892x Isolator Amplifier Series X = Base part number 1 = Differential output 2 = Single-ended output S = Specified linear input range A = ±62.5 mV for Si8921, 8 to 68.5 mV for Si8922 B = ±250 mV for Si8921, 30 to 274 mV for Si8922 V = Insulation rating B = 2.5 kV _{RMS}
Line 2	CC = Country of origin ISO code abbreviation YY = Year WW = Work Week	Year and work week
Line 3	TTTTT - Manufacturing code Circle = 19.7 mils diameter left justified	Manufacturing code The first character is a letter in the range N through Z to indicate Automotive Grade

11. Tape and Reel Information



206437-049

Figure 49. Wide Body Carrier Tape Information

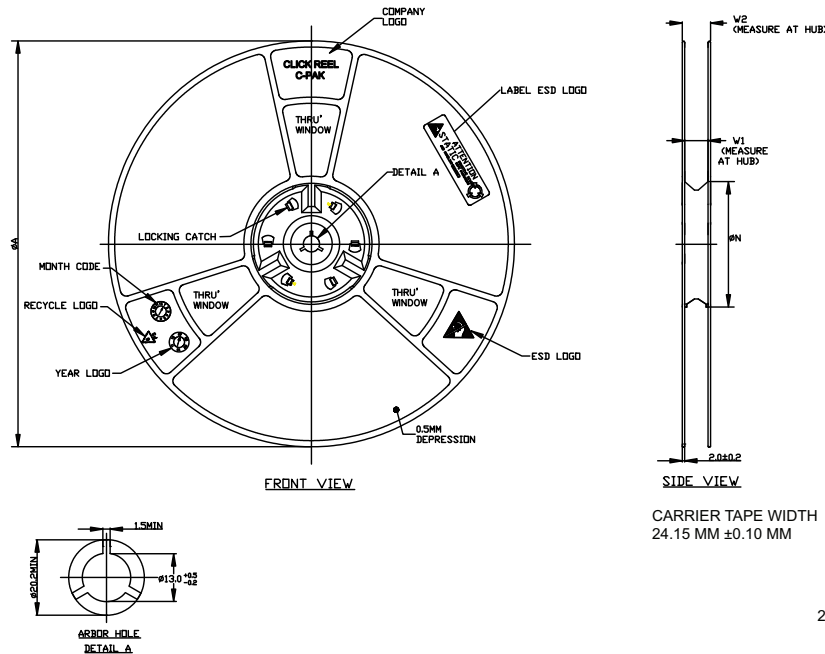

206437-050

Figure 50. Wide Body Reel Information

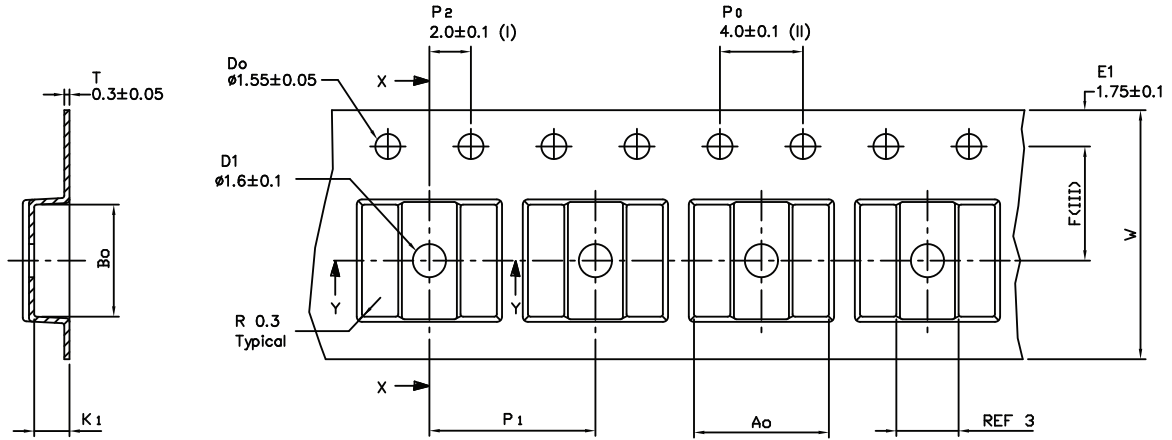

SECTION X - X

Ao	6.50 +/- 0.1
Bo	5.40 +/- 0.1
Ko	2.00 +/- 0.1
K1	1.70 +/- 0.1
F	5.50 +/- 0.1
P1	8.00 +/- 0.1
W	12.00 +0.3/-0.0

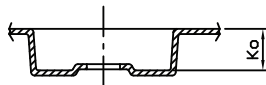

SECTION Y - Y

- (I) Measured from centreline of sprocket hole to centreline of pocket.
- (II) Cumulative tolerance of 10 sprocket holes is ± 0.20 .
- (III) Measured from centreline of sprocket hole to centreline of pocket.
- (IV) Other material available.

ALL DIMENSIONS IN MILLIMETRES UNLESS OTHERWISE STATED.

206437-051

Figure 51. Narrow Body Carrier Tape Information

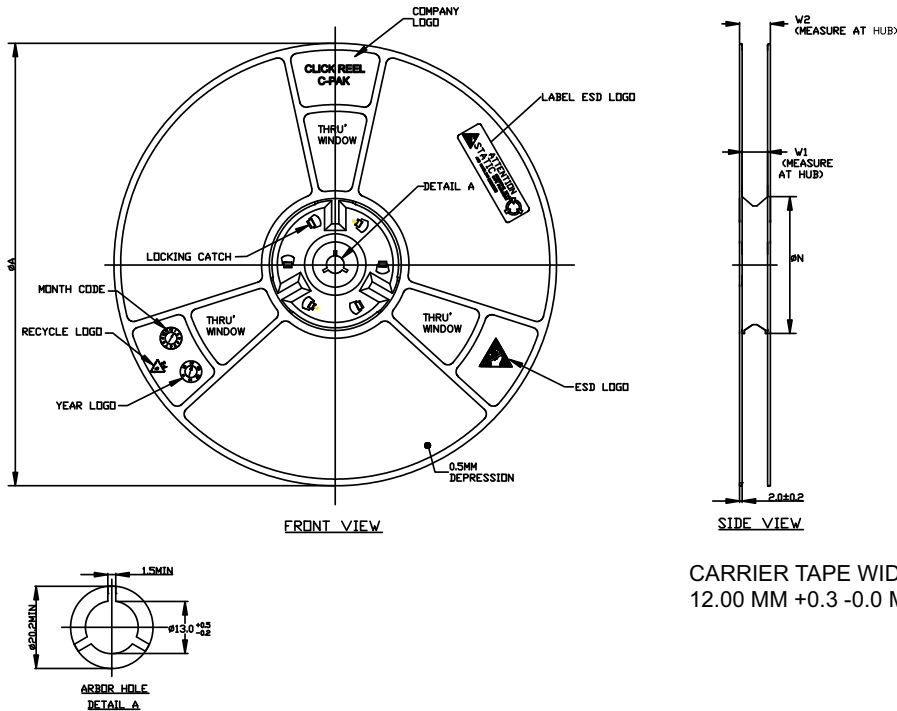

CARRIER TAPE WIDTH
12.00 MM +0.3 -0.0 MM

206437-052

Figure 52. Narrow Body Reel Information

12. Ordering Information

Industrial and Automotive Grade Ordering Part Numbers (OPNs)

Industrial-grade devices (part numbers with an “-I” in their suffix) are built using well-controlled, high-quality manufacturing flows to ensure robustness and reliability. Qualifications are compliant with JEDEC, and defect reduction methodologies are used throughout definition, design, evaluation, qualification, and mass production steps.

Automotive-grade devices (part numbers with an “-A” in their suffix) are built using automotive-specific flows at all steps in the manufacturing process to ensure robustness and low defectivity. These devices are supported with AIAG-compliant Production Part Approval Process (PPAP) documentation, and feature International Material Data System (IMDS) and China Automotive Material Data System (CAMDS) listings. Qualifications are compliant with AEC-Q100, and a zero-defect methodology is maintained throughout definition, design, evaluation, qualification, and mass production steps.

Ordering Part Number ^{1, 2, 3}	Automotive Ordering Part Number ^{1, 2, 3, 4, 5}	Ordering Options			
		Specified Input Range	Isolation Rating	Output	Package Type
Si8921AD-IS4	Si8921AD-AS4	±62.5 mV	5.0 kV _{RMS}	Differential	WB stretched SOIC-8
Si8921BD-IS4	Si8921BD-AS4	±250 mV	5.0 kV _{RMS}	Differential	WB stretched SOIC-8
Si8921AB-IS	Si8921AB-AS	±62.5 mV	2.5 kV _{RMS}	Differential	NB SOIC-8
Si8921BB-IS	Si8921BB-AS	±250 mV	2.5 kV _{RMS}	Differential	NB SOIC-8
Si8922AD-IS4	Si8922AD-AS4	8 to 68.5 mV	5.0 kV _{RMS}	Single-ended	WB stretched SOIC-8
Si8922BD-IS4	Si8922BD-AS4	30 to 274 mV	5.0 kV _{RMS}	Single-ended	WB stretched SOIC-8
Si8922AB-IS	Si8922AB-AS	8 to 68.5 mV	2.5 kV _{RMS}	Single-ended	NB SOIC-8
Si8922BB-IS	Si8922BB-AS	30 to 274 mV	2.5 kV _{RMS}	Single-ended	NB SOIC-8

1. All packages are RoHS-compliant.
2. “Si” and “SI” are used interchangeably.
3. An “R” at the end of the part number denotes tape and reel packaging option.
4. Automotive-grade devices (“-A” suffix) are identical in construction materials, topside marking, and electrical parameters to their Industrial Grade (“-I suffix”) version counterparts. Automotive-Grade products are produced utilizing full automotive process flows and additional statistical process controls throughout the manufacturing flow. The Automotive-Grade part number is included on shipping labels.
5. In the top markings of each device, the Manufacturing Code represented by “TTTTTT” contains as its first character a letter in the range N through Z to indicate Automotive Grade.

13. Revision History

Revision C

September, 2023

Updated regulatory information, updated absolute maximum note 1, and removed unneeded minimum IDD specifications.

Revision B

May, 2023

Re-formatted to new standards. Added new text for Automotive Grade products, AEC-Q100 qualification, added tape and reel information, added MSL ratings, updated THD specifications, updated specified linear input range, updated block diagrams on page 1 and updated Si8922 pin description.

Revision 206437A

December, 2022

Updated decimal-based revision number to alphanumeric code.

Revision 0.9

September, 2022

Updated Safety Approvals. Updated minimum supply currents in Electrical Specifications. Updated Regulatory Information.

Revision 0.8

June, 2021

Added Automotive OPNs and updated specified input range in Ordering Guide. Updated Current Sense Application figure. Added linearity minimum specification to Table 4.1 Electrical Specifications.

Revision 0.7

April, 2020

Numerous clarifications throughout. Updated Electrical Specifications after full characterization. Changed Si8922 Pin 6 from NC to GND.

Revision 0.51

June, 2019

Added section for Automotive Grade OPNs. Corrected error in Specified Linear Input Range. Changed DTI Specification. Corrected Si8922 Pin Diagram. Updated supply currents.

Revision 0.5

March, 2019

Updated specifications. Added narrow body SOIC-8 package.

Revision 0.1

February, 2018

Initial release.

Copyright © 2018-2023, Skyworks Solutions, Inc. All Rights Reserved.

Information in this document is provided in connection with Skyworks Solutions, Inc. ("Skyworks") products or services. These materials, including the information contained herein, are provided by Skyworks as a service to its customers and may be used for informational purposes only by the customer. Skyworks assumes no responsibility for errors or omissions in these materials or the information contained herein. Skyworks may change its documentation, products, services, specifications or product descriptions at any time, without notice. Skyworks makes no commitment to update the materials or information and shall have no responsibility whatsoever for conflicts, incompatibilities, or other difficulties arising from any future changes.

No license, whether express, implied, by estoppel or otherwise, is granted to any intellectual property rights by this document. Skyworks assumes no liability for any materials, products or information provided hereunder, including the sale, distribution, reproduction or use of Skyworks products, information or materials, except as may be provided in Skyworks' Terms and Conditions of Sale.

THE MATERIALS, PRODUCTS AND INFORMATION ARE PROVIDED "AS IS" WITHOUT WARRANTY OF ANY KIND, WHETHER EXPRESS, IMPLIED, STATUTORY, OR OTHERWISE, INCLUDING FITNESS FOR A PARTICULAR PURPOSE OR USE, MERCHANTABILITY, PERFORMANCE, QUALITY OR NON-INFRINGEMENT OF ANY INTELLECTUAL PROPERTY RIGHT; ALL SUCH WARRANTIES ARE HEREBY EXPRESSLY DISCLAIMED. SKYWORKS DOES NOT WARRANT THE ACCURACY OR COMPLETENESS OF THE INFORMATION, TEXT, GRAPHICS OR OTHER ITEMS CONTAINED WITHIN THESE MATERIALS. SKYWORKS SHALL NOT BE LIABLE FOR ANY DAMAGES, INCLUDING BUT NOT LIMITED TO ANY SPECIAL, INDIRECT, INCIDENTAL, STATUTORY, OR CONSEQUENTIAL DAMAGES, INCLUDING WITHOUT LIMITATION, LOST REVENUES OR LOST PROFITS THAT MAY RESULT FROM THE USE OF THE MATERIALS OR INFORMATION, WHETHER OR NOT THE RECIPIENT OF MATERIALS HAS BEEN ADVISED OF THE POSSIBILITY OF SUCH DAMAGE.



Skyworks products are not intended for use in medical, lifesaving or life-sustaining applications, or other equipment in which the failure of the Skyworks products could lead to personal injury, death, physical or environmental damage. Skyworks customers using or selling Skyworks products for use in such applications do so at their own risk and agree to fully indemnify Skyworks for any damages resulting from such improper use or sale.

Customers are responsible for their products and applications using Skyworks products, which may deviate from published specifications as a result of design defects, errors, or operation of products outside of published parameters or design specifications. Customers should include design and operating safeguards to minimize these and other risks. Skyworks assumes no liability for applications assistance, customer product design, or damage to any equipment resulting from the use of Skyworks products outside of Skyworks' published specifications or parameters.

Skyworks, the Skyworks symbol, Sky5®, SkyOne®, SkyBlue™, Skyworks Green™, ClockBuilder®, DSPLL®, ISOModem®, ProSLIC®, SiPHY®, and RFelC® are trademarks or registered trademarks of Skyworks Solutions, Inc. or its subsidiaries in the United States and other countries. Third-party brands and names are for identification purposes only and are the property of their respective owners. Additional information, including relevant terms and conditions, posted at www.skyworksinc.com, are incorporated by reference.

Looking for pricing, stock, or lifecycle information?

Click below to explore more details on WIN SOURCE:

-  [View S18922BB-IS on WIN SOURCE](#)
-  [Skyworks Solutions Inc. Information](#)

Optimize Your Supply Chain with WIN SOURCE Solutions

-  Global Sourcing Solution
-  Obsolete Management
-  Cost Control Management
-  Shortage Management
-  Alternative Solution
-  Excess Inventory Management