



**THE DATASHEET OF
DTJ1524S12**



15 Watts

- Regulated single & dual outputs from 3.3V to 30VDC
- Wide 4:1 input range
- Chassis mount with optional DIN rail clip
- UL62368-1 safety approvals
- EN55032 class A
- Remote On/Off & voltage trim function
- 3kVDC isolation
- -40°C to +100°C operating temperature
- Full power to 80°C
- 3 year warranty

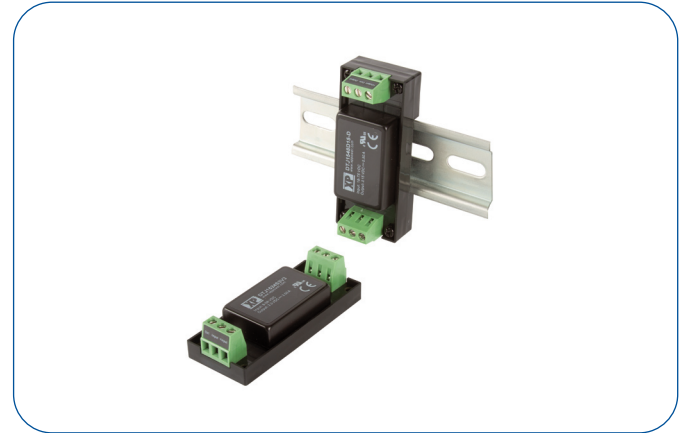

Dimensions:

DTJ15:

3.00 x 1.24 x 0.77" (76.2 x 31.4 x 19.4 mm)

The DTJ series of chassis mount DC-DC power supplies allows for easy and convenient integration into a variety of industrial and commercial applications. The DC-DC power solution is constructed using lightweight materials and includes features such as short circuit protection, input reverse polarity protection and soft start. The wide input range covers nominal voltages of 12V, 24V and 48V.

Models & Ratings

Input Voltage	Output Voltage	Output Current	Input Current ^(1,5)		Maximum Capacitive Load ⁽⁶⁾	Efficiency ⁽²⁾	Model Number ^(3,4)
			No Load	Full Load			
24V (9-36V)	3.3V	3.00 A	10 mA	510 mA	3300 µF	81%	DTJ1524S3V3
	5.0V	3.00 A	10 mA	744 mA	3300 µF	84%	DTJ1524S05
	12.0V	1.25 A	10 mA	718 mA	680 µF	87%	DTJ1524S12
	15.0V	1.00 A	15 mA	710 mA	470 µF	88%	DTJ1524S15
	±5.0V	±1.50 A	10 mA	744 mA	±2200 µF	84%	DTJ1524D05
	±12.0V	±0.63 A	15 mA	718 mA	±470 µF	87%	DTJ1524D12
48V (18-75V)	±15.0V	±0.50 A	15 mA	710 mA	±330 µF	88%	DTJ1524D15
	3.3V	3.00 A	10 mA	254 mA	3300 µF	81%	DTJ1548S3V3
	5.0V	3.00 A	10 mA	372 mA	3300 µF	84%	DTJ1548S05
	12.0V	1.25 A	10 mA	363 mA	680 µF	86%	DTJ1548S12
	15.0V	1.00 A	10 mA	359 mA	470 µF	87%	DTJ1548S15
	±5.0V	±1.50 A	8 mA	359 mA	±2200 µF	87%	DTJ1548D05
	±12.0V	±0.63 A	8 mA	351 mA	±470 µF	89%	DTJ1548D12
	±15.0V	±0.50 A	10 mA	359 mA	±330 µF	87%	DTJ1548D15

Notes

1. Input current measured at nominal input voltage.
2. Typical values.
3. For optional version fitted with DIN Clip add suffix '-D' e.g. DTJ1524S12-D.
4. For optional factory fitted heatsink add suffix '-HK' e.g. DTJ1524S12-HK or DTJ1524S12-HKD with DIN clip.
5. Input current is typically 2.0mA at nominal input voltage when output is remotely turned off.
6. Per output.

Input

Characteristic	Minimum	Typical	Maximum	Units	Notes & Conditions
Input Voltage Range	9		36	VDC	12 V & 24 V nominal input voltage
	18		75	VDC	24 V & 48 V nominal input voltage
Input Current					See Models and Ratings table
Inrush Current		35/45		A	DTJ1524 / DTJ1548 series
Reflected Ripple Current		20		mAp-p	Measured with 12µH and 47µF source values
Input Filter	Pi type				
Undervoltage Lockout	On at >8.8V. Off <8.0V				DTJ1524 series
	On at >17.5V. Off <16.0V				DTJ1548 series
Input Surge			50	VDC	DTJ1524 series for 100 ms
			100	VDC	DTJ1548 series for 100 ms
Reverse Polarity	Integrated protection				
Remote On/Off (positive logic)	On: Logic High (3.0-12 V) or open circuit pin 1.				
	Off: Logic Low (<1.2 V) or short pin 2 to pin 1.				
	Idle Current: 2 mA, typical				

Output

Characteristic	Minimum	Typical	Maximum	Units	Notes & Conditions
Output Voltage	3V3		30	V	See models and ratings table
Output Voltage Trim			±10	%	See application notes
Initial Set Accuracy			±3	%	At full load
Minimum Load	0			A	No minimum load required
Start Up Delay		30		ms	At nominal input voltage
Line Regulation			±0.5	%	From minimum to maximum input voltage
Load Regulation			±0.5/±1.0	%	0 - 100% load. single/dual with balanced load
Cross Regulation			±5	%	On dual output models with one output at 25% load and the other varied from 10% to 100% load.
Transient Response			±8/±5	% deviation	3.3V single output / All other models. Recovery to within 1% in <250 µs for a 25% load change
Ripple & Noise			75	mV pk-pk	Single output. 20MHz bandwidth with 10µF/25V MLCC
			60		Dual output. 20MHz bandwidth with 10µF/25V MLCC
Short Circuit Protection					Continuous. Trip (hiccup mode), auto recovery
Overload Protection		170		%	Trip & restart (hiccup mode)
Overvoltage Protection		140		%Vout	Internal voltage clamp
Temperature Coefficient			±0.02	%/°C	

General

Characteristic	Minimum	Typical	Maximum	Units	Notes & Conditions
Efficiency		86		%	See Models and Ratings table
Isolation	3000			VDC	For 60 s functional
Isolation Resistance	1000			MΩ	
Input to Output Capacitance		2000		pF	
Switching Frequency		270/330		kHz	3.3 & 5V single output / All other models
Mean Time Between Failure	500			kHrs	MIL-HDBK-217F, +25 °C GB
Case Material	Non conductive, black plastic UL94V-0. Power module copper case with epoxy potting UL94V-0				
Weight		0.099 (45.0)		lb (g)	DIN rail option add 0.011lbs (5.0g) Heatsink option add 0.014lbs (6.5g)

Environmental

Characteristic	Minimum	Typical	Maximum	Units	Notes & Conditions
Operating Temperature	-40		+100	°C	See derating curves
Storage Temperature	-55		+125	°C	
Case Temperature			+105	°C	
Thermal Impedance to Air	12			°C/W	With heatsink 11°C/W
Humidity	5		95	%RH	Non-condensing
Cooling					Natural convection, 20 LFM
Altitude			5000	m	Operating

EMC: Emissions

Phenomenon	Standard	Test Level	Notes & Conditions
Conducted	EN55032	Class A	
Radiated	EN55032	Class A	

EMC: Immunity

Phenomenon	Standard	Test Level	Criteria	Notes & Conditions
Immunity	EN55035			
ESD Immunity	EN61000-4-2	±6 kV Contact, ±8 kV Air	B	
Radiated Immunity	EN61000-4-3	10 V/m	A	
EFT/Burst	EN61000-4-4	±2 kV	A	Requires additional 330µF, 100V capacitor across input terminals
Surges	EN61000-4-5	±2 kV	A	
Conducted Immunity	EN61000-4-6	10 Vrms	A	
Magnetic Fields	EN61000-4-8	100 A/m	A	

Safety Approvals

Safety Agency	Safety Standard	Notes & Conditions
UL	UL60950-1/62368-1	
CE	Meets all applicable directives	
UKCA	Meets all applicable legislation	

Application Notes

Derating Curve for Convection Cooling

Without Heatsink

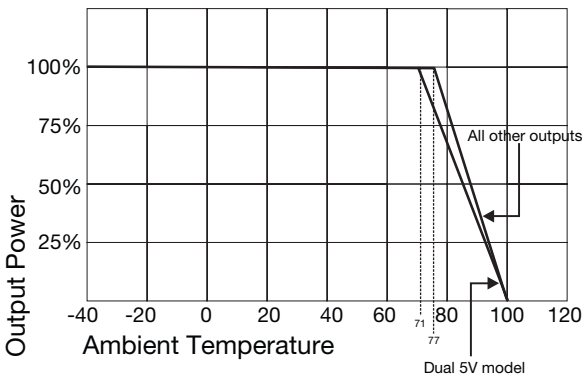

With Heatsink

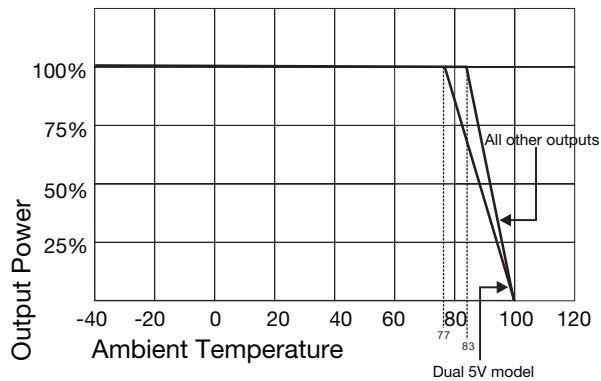

External Output Trimming

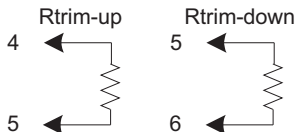

Output can be externally trimmed by using the method as below, (single output models only)

Trim Down Resistor Values

Model	1%	2%	3%	4%	5%	6%	7%	8%	9%	10%
3V3	309.0 k	165.4 k	105.6 k	72.9 k	52.3 k	38.0 k	27.6 k	19.7 k	13.5 k	8.40 k
5V	119.9 k	77.70 k	50.50 k	35.2 k	25.3 k	18.4 k	13.4 k	9.50 k	6.40 k	3.90 k
12V	345.0 k	138.1 k	79.90 k	51.5 k	34.6 k	23.4 k	15.5 k	9.50 k	4.90 k	1.26 k
15V	174.4 k	91.10 k	56.60 k	37.7 k	25.8 k	17.6 k	11.6 k	7.00 k	3.50 k	0.55 k

Trim Up Resistor Values

Model	1%	2%	3%	4%	5%	6%	7%	8%	9%	10%
3V3	537.7 k	177.1 k	96.40 k	60.8 k	40.8 k	27.9 k	19.0 k	12.4 k	7.30 k	3.40 k
5V	635.2 k	170.0 k	92.80 k	61.1 k	43.8 k	32.9 k	25.4 k	20.0 k	15.8 k	12.5 k
12V	367.4 k	179.6 k	113.6 k	79.9 k	59.5 k	45.8 k	35.9 k	28.5 k	22.7 k	18.1 k
15V	661.5 k	231.3 k	134.0 k	91.0 k	66.8 k	51.3 k	40.4 k	32.5 k	26.4 k	21.5 k

Mechanical Details

Chassis Mount

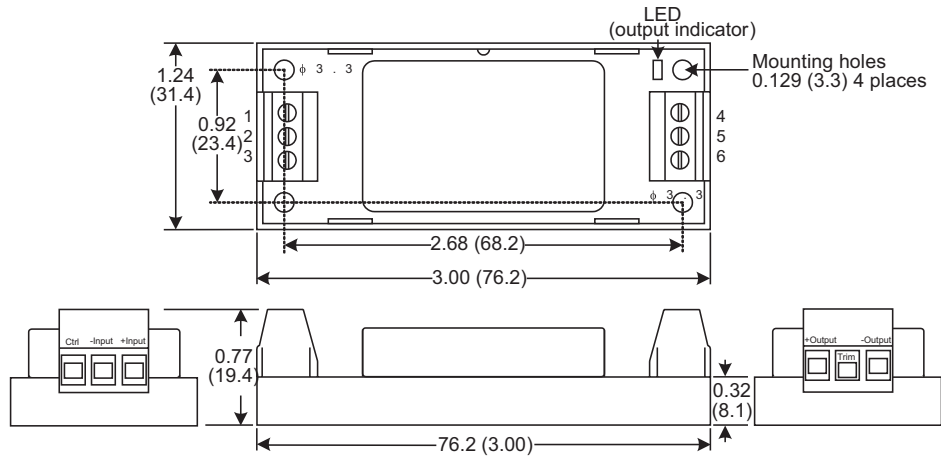

Chassis Mount with Heatsink -HK

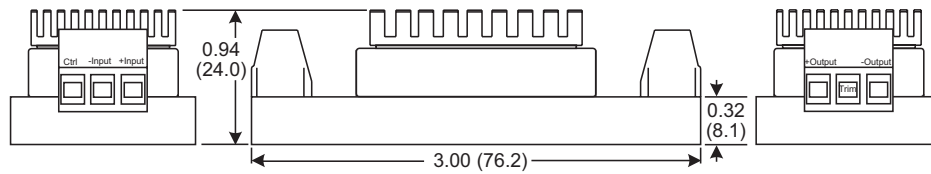

DIN Rail -D

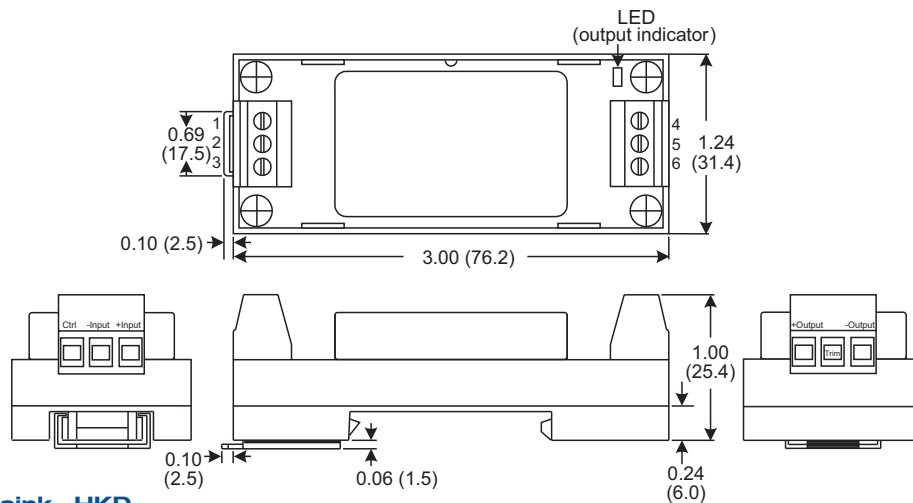

DIN Rail with Heatsink -HKD

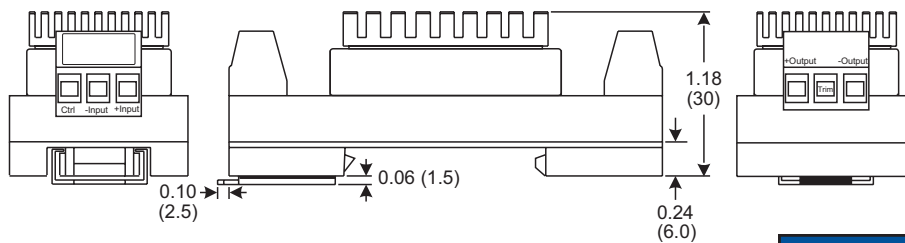



Notes

- All dimensions are in inches (mm)
- Weight: 0.099 lbs (45 g) approx
- Weight for -D version: 0.121 lbs (55 g) approx
- Terminal wire size 24 ~12 AWG
- Screw terminal torque 7 lb-in (0.79 Nm)
- Case tolerance: ± 0.02 (± 0.5)
- Mounting rail: TS35
- Heatsink is aluminium black anodic
- Heatsink weight 0.014 (6.5g)







Pin Connections		
Pin	Single Output	Dual Output
1	Remote On/Off	Remote On/Off
2	-Vin	-Vin
3	+Vin	+Vin
4	-Vout	-Vout
5	Trim	Common
6	+Vout	+Vout

Looking for pricing, stock, or lifecycle information?

Click below to explore more details on WIN SOURCE:

-  [View DTJ1524S12 on WIN SOURCE](#)
-  [XP Power Information](#)

Optimize Your Supply Chain with WIN SOURCE Solutions

-  Global Sourcing Solution
-  Obsolete Management
-  Cost Control Management
-  Shortage Management
-  Alternative Solution
-  Excess Inventory Management