



**THE DATASHEET OF
LGU1V153MELC**



LGU Snap-in Terminal Type, 105°C Standard

- Withstanding 3000 hours application of rated ripple current at 105°C.
- Compliant to the RoHS directive (2011/65/EU,(EU)2015/863).



Specifications

| Item | Performance Characteristics | | | | | | | | | |
|-------------------------------|---|---------------------|-----------|------|--------------------|---|------------|------------|------|--|
| Category Temperature Range | - 40 to + 105°C (16 to 250V) , - 25 to +105°C (315 to 450V) | | | | | | | | | |
| Rated Voltage Range | 16 to 450V | | | | | | | | | |
| Rated Capacitance Range | 47 to 47000μF | | | | | | | | | |
| Capacitance Tolerance | ±20% at 120Hz, 20°C | | | | | | | | | |
| Leakage Current | $I \leq 3\sqrt{CV}$ (μA) (After 5 minutes' application of rated voltage at 20°C) [C : Rated Capacitance (μF) V : Voltage (V)] | | | | | | | | | |
| Tangent of loss angle (tan δ) | Measurement frequency : 120Hz at 20°C | | | | | | | | | |
| | Rated voltage (V) | 16 | 25 | 35 | 50 | 63 | 80·100 | 160 to 420 | 450 | |
| | tan δ (max.) | 0.50 | 0.40 | 0.35 | 0.30 | 0.25 | 0.20 | 0.15 | 0.20 | |
| Stability at Low Temperature | Measurement frequency : 120Hz | | | | | | | | | |
| | Rated voltage (V) | | 16 to 100 | | 160 to 250 | | 315 to 450 | | | |
| | Impedance ratio (max.) | Z(-25°C) / Z(+20°C) | 4 | | 3 | | 8 | | | |
| | | Z(-40°C) / Z(+20°C) | 20 | | 12 | | — | | | |
| Endurance | The specifications listed at right shall be met when the capacitors are restored to 20°C after D.C. bias plus rated ripple current is applied for 3000 hours at 105°C, the peak voltage shall not exceed the rated voltage. | | | | Capacitance change | Within ±20% of the initial capacitance value | | | | |
| | | | | | tan δ | 200% or less than the initial specified value | | | | |
| | | | | | Leakage current | Less than or equal to the initial specified value | | | | |
| Shelf Life | After storing the capacitors under no load at 105°C for 1000 hours and then performing voltage treatment based on JIS C 5101-4 clause 4.1 at 20°C, they shall meet the characteristic requirements listed at right. | | | | Capacitance change | Within ±15% of the initial capacitance value | | | | |
| | | | | | tan δ | 150% or less than the initial specified value | | | | |
| | | | | | Leakage current | Less than or equal to the initial specified value | | | | |
| Marking | Printed with white color letter on black sleeve. | | | | | | | | | |

Drawing

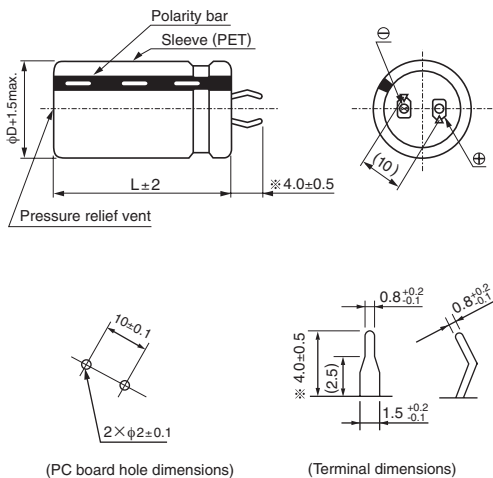

Type numbering system (Example : 200V 680μF)

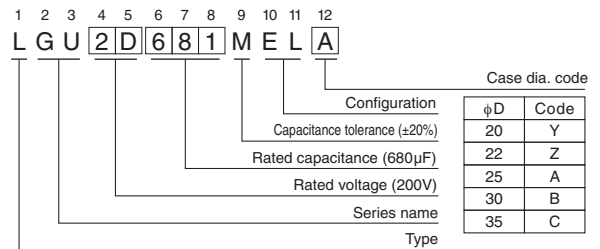

※ Other terminations available upon request.
Please refer to the Guidelines for Aluminum Electrolytic Capacitors.

Frequency coefficient of rated ripple current

| Frequency (Hz) | 50 | 60 | 120 | 300 | 1k | 10k | 50k or more | |
|----------------|-------------|------|------|------|------|------|-------------|------|
| Coeff. | 16 to 100V | 0.88 | 0.90 | 1.00 | 1.07 | 1.15 | 1.15 | 1.15 |
| | 160 to 250V | 0.81 | 0.85 | 1.00 | 1.17 | 1.32 | 1.45 | 1.50 |
| | 315 to 450V | 0.77 | 0.82 | 1.00 | 1.16 | 1.30 | 1.41 | 1.43 |

● Dimension table in next page.



■ Dimensions

| 16V (1C) | | | | |
|-----------|----------------|----------------------|----------------------|--------------|
| Cap. (μF) | Size φD×L (mm) | Rated ripple (mArms) | Leakage Current (mA) | Code |
| 6800 | 22 × 25 | 1750 | 0.98 | LGU1C682MELZ |
| 8200 | 22 × 30 | 2000 | 1.08 | LGU1C822MELZ |
| 10000 | 22 × 30 | 2100 | 1.20 | LGU1C103MELZ |
| | 25 × 25 | 2050 | 1.20 | LGU1C103MELA |
| 12000 | 22 × 35 | 2310 | 1.31 | LGU1C123MELZ |
| | 25 × 30 | 2300 | 1.31 | LGU1C123MELA |
| | 30 × 25 | 2380 | 1.31 | LGU1C123MELB |
| 15000 | 22 × 40 | 2680 | 1.46 | LGU1C153MELZ |
| | 25 × 35 | 2680 | 1.46 | LGU1C153MELA |
| | 30 × 30 | 2570 | 1.46 | LGU1C153MELB |
| 18000 | 22 × 45 | 2980 | 1.60 | LGU1C183MELZ |
| | 25 × 40 | 3160 | 1.60 | LGU1C183MELA |
| | 30 × 30 | 3000 | 1.60 | LGU1C183MELB |
| 22000 | 25 × 45 | 3400 | 1.77 | LGU1C223MELA |
| | 30 × 35 | 3390 | 1.77 | LGU1C223MELB |
| | 35 × 30 | 3250 | 1.77 | LGU1C223MELC |
| 27000 | 25 × 50 | 3850 | 1.97 | LGU1C273MELA |
| | 30 × 40 | 3830 | 1.97 | LGU1C273MELB |
| | 35 × 30 | 3740 | 1.97 | LGU1C273MELC |
| 33000 | 30 × 45 | 4300 | 2.17 | LGU1C333MELB |
| | 35 × 35 | 4270 | 2.17 | LGU1C333MELC |
| 39000 | 30 × 50 | 4810 | 2.36 | LGU1C393MELB |
| | 35 × 40 | 4800 | 2.36 | LGU1C393MELC |
| 47000 | 35 × 45 | 5530 | 2.60 | LGU1C473MELC |

| 25V (1E) | | | | |
|-----------|----------------|----------------------|----------------------|--------------|
| Cap. (μF) | Size φD×L (mm) | Rated ripple (mArms) | Leakage Current (mA) | Code |
| 4700 | 22 × 25 | 1610 | 1.02 | LGU1E472MELZ |
| 5600 | 22 × 30 | 1800 | 1.12 | LGU1E562MELZ |
| 6800 | 22 × 30 | 1910 | 1.23 | LGU1E682MELZ |
| | 25 × 25 | 1910 | 1.23 | LGU1E682MELA |
| 8200 | 22 × 35 | 2140 | 1.35 | LGU1E822MELZ |
| | 25 × 30 | 2340 | 1.35 | LGU1E822MELA |
| | 30 × 25 | 2250 | 1.35 | LGU1E822MELB |
| 10000 | 22 × 40 | 2650 | 1.50 | LGU1E103MELZ |
| | 25 × 35 | 2610 | 1.50 | LGU1E103MELA |
| | 30 × 30 | 2610 | 1.50 | LGU1E103MELB |
| 12000 | 22 × 45 | 2690 | 1.64 | LGU1E123MELZ |
| | 25 × 40 | 2810 | 1.64 | LGU1E123MELA |
| | 30 × 30 | 2740 | 1.64 | LGU1E123MELB |
| 15000 | 25 × 45 | 3270 | 1.83 | LGU1E153MELA |
| | 30 × 35 | 3130 | 1.83 | LGU1E153MELB |
| | 35 × 30 | 3260 | 1.83 | LGU1E153MELC |
| 18000 | 25 × 50 | 3540 | 2.01 | LGU1E183MELA |
| | 30 × 40 | 3560 | 2.01 | LGU1E183MELB |
| | 35 × 35 | 3840 | 2.01 | LGU1E183MELC |
| 22000 | 30 × 45 | 4240 | 2.22 | LGU1E223MELB |
| | 35 × 35 | 3960 | 2.22 | LGU1E223MELC |
| 27000 | 35 × 45 | 4750 | 2.46 | LGU1E273MELC |
| 33000 | 35 × 50 | 5500 | 2.72 | LGU1E333MELC |

| 35V (1V) | | | | |
|-----------|----------------|----------------------|----------------------|--------------|
| Cap. (μF) | Size φD×L (mm) | Rated ripple (mArms) | Leakage Current (mA) | Code |
| 3300 | 22 × 25 | 1450 | 1.01 | LGU1V332MELZ |
| 3900 | 22 × 30 | 1690 | 1.10 | LGU1V392MELZ |
| 4700 | 22 × 35 | 2020 | 1.21 | LGU1V472MELZ |
| | 25 × 25 | 1780 | 1.21 | LGU1V472MELA |
| 5600 | 22 × 35 | 2130 | 1.32 | LGU1V562MELZ |
| | 25 × 30 | 2040 | 1.32 | LGU1V562MELA |
| | 30 × 25 | 2120 | 1.32 | LGU1V562MELB |
| 6800 | 22 × 40 | 2410 | 1.46 | LGU1V682MELZ |
| | 25 × 35 | 2310 | 1.46 | LGU1V682MELA |
| | 30 × 25 | 2310 | 1.46 | LGU1V682MELB |
| 8200 | 22 × 50 | 2850 | 1.60 | LGU1V822MELZ |
| | 25 × 40 | 2730 | 1.60 | LGU1V822MELA |
| | 30 × 30 | 2750 | 1.60 | LGU1V822MELB |
| 10000 | 25 × 45 | 3050 | 1.77 | LGU1V103MELA |
| | 30 × 35 | 3050 | 1.77 | LGU1V103MELB |
| | 25 × 50 | 3370 | 1.94 | LGU1V123MELA |
| 12000 | 30 × 40 | 3280 | 1.94 | LGU1V123MELB |
| | 35 × 30 | 3200 | 1.94 | LGU1V123MELC |
| | 30 × 45 | 3740 | 2.17 | LGU1V153MELB |
| 15000 | 35 × 35 | 3690 | 2.17 | LGU1V153MELC |
| | 18000 | 35 × 40 | 4370 | 2.38 |
| 22000 | 35 × 50 | 4920 | 2.63 | LGU1V223MELC |

| 50V (1H) | | | | |
|-----------|----------------|----------------------|----------------------|--------------|
| Cap. (μF) | Size φD×L (mm) | Rated ripple (mArms) | Leakage Current (mA) | Code |
| 1800 | 22 × 25 | 1340 | 0.90 | LGU1H182MELZ |
| 2700 | 22 × 30 | 1700 | 1.10 | LGU1H272MELZ |
| | 25 × 25 | 1700 | 1.10 | LGU1H272MELA |
| 3300 | 22 × 35 | 1980 | 1.21 | LGU1H332MELZ |
| | 25 × 30 | 2000 | 1.21 | LGU1H332MELA |
| 3900 | 22 × 40 | 2250 | 1.32 | LGU1H392MELZ |
| | 25 × 30 | 2280 | 1.32 | LGU1H392MELA |
| | 30 × 25 | 2220 | 1.32 | LGU1H392MELB |
| 4700 | 22 × 45 | 2560 | 1.45 | LGU1H472MELZ |
| | 25 × 35 | 2610 | 1.45 | LGU1H472MELA |
| | 30 × 30 | 2580 | 1.45 | LGU1H472MELB |
| 5600 | 22 × 50 | 2890 | 1.58 | LGU1H562MELZ |
| | 25 × 40 | 2810 | 1.58 | LGU1H562MELA |
| | 30 × 30 | 2950 | 1.58 | LGU1H562MELB |
| 6800 | 25 × 45 | 3370 | 1.74 | LGU1H682MELA |
| | 30 × 35 | 3390 | 1.74 | LGU1H682MELB |
| | 35 × 30 | 3310 | 1.74 | LGU1H682MELC |
| 8200 | 30 × 40 | 3710 | 1.92 | LGU1H822MELB |
| | 35 × 35 | 3660 | 1.92 | LGU1H822MELC |
| 10000 | 30 × 50 | 4090 | 2.12 | LGU1H103MELB |
| | 35 × 40 | 4070 | 2.12 | LGU1H103MELC |
| 12000 | 35 × 45 | 4560 | 2.32 | LGU1H123MELC |
| 15000 | 35 × 50 | 4770 | 2.59 | LGU1H153MELC |

Rated ripple current (mArms) at 105°C 120Hz



■ Dimensions

| 63V (1J) | | | | |
|-----------|----------------|----------------------|----------------------|--------------|
| Cap. (μF) | Size φD×L (mm) | Rated ripple (mArms) | Leakage Current (mA) | Code |
| 1200 | 22 × 25 | 1250 | 0.82 | LGU1J122MELZ |
| 1500 | 22 × 30 | 1470 | 0.92 | LGU1J152MELZ |
| | 25 × 25 | 1440 | 0.92 | LGU1J152MELA |
| 1800 | 22 × 30 | 1580 | 1.01 | LGU1J182MELZ |
| | 25 × 25 | 1520 | 1.01 | LGU1J182MELA |
| 2200 | 22 × 35 | 1820 | 1.11 | LGU1J222MELZ |
| | 25 × 30 | 1750 | 1.11 | LGU1J222MELA |
| 2700 | 22 × 40 | 2070 | 1.23 | LGU1J272MELZ |
| | 25 × 35 | 2110 | 1.23 | LGU1J272MELA |
| | 30 × 25 | 1930 | 1.23 | LGU1J272MELB |
| 3300 | 22 × 45 | 2330 | 1.36 | LGU1J332MELZ |
| | 25 × 35 | 2270 | 1.36 | LGU1J332MELA |
| | 30 × 30 | 2240 | 1.36 | LGU1J332MELB |
| 3900 | 25 × 40 | 2540 | 1.48 | LGU1J392MELA |
| | 30 × 35 | 2550 | 1.48 | LGU1J392MELB |
| 4700 | 25 × 50 | 2970 | 1.63 | LGU1J472MELA |
| | 30 × 40 | 2900 | 1.63 | LGU1J472MELB |
| | 35 × 30 | 2830 | 1.63 | LGU1J472MELC |
| 5600 | 30 × 40 | 3280 | 1.78 | LGU1J562MELB |
| | 35 × 35 | 3240 | 1.78 | LGU1J562MELC |
| 6800 | 30 × 50 | 3730 | 1.96 | LGU1J682MELB |
| | 35 × 40 | 3710 | 1.96 | LGU1J682MELC |
| 8200 | 35 × 45 | 4160 | 2.15 | LGU1J822MELC |
| 10000 | 35 × 50 | 4690 | 2.38 | LGU1J103MELC |

| 80V (1K) | | | | |
|-----------|----------------|----------------------|----------------------|--------------|
| Cap. (μF) | Size φD×L (mm) | Rated ripple (mArms) | Leakage Current (mA) | Code |
| 820 | 22 × 25 | 1110 | 0.76 | LGU1K821MELZ |
| 1000 | 22 × 25 | 1290 | 0.84 | LGU1K102MELZ |
| 1200 | 22 × 30 | 1440 | 0.92 | LGU1K122MELZ |
| | 25 × 25 | 1390 | 0.92 | LGU1K122MELA |
| 1500 | 22 × 30 | 1610 | 1.03 | LGU1K152MELZ |
| | 25 × 25 | 1620 | 1.03 | LGU1K152MELA |
| 1800 | 22 × 35 | 1830 | 1.13 | LGU1K182MELZ |
| | 25 × 30 | 1860 | 1.13 | LGU1K182MELA |
| | 30 × 25 | 1810 | 1.13 | LGU1K182MELB |
| 2200 | 22 × 40 | 2090 | 1.25 | LGU1K222MELZ |
| | 25 × 35 | 2010 | 1.25 | LGU1K222MELA |
| | 30 × 25 | 2100 | 1.25 | LGU1K222MELB |
| 2700 | 25 × 40 | 2430 | 1.39 | LGU1K272MELA |
| | 30 × 30 | 2430 | 1.39 | LGU1K272MELB |
| 3300 | 25 × 45 | 2760 | 1.54 | LGU1K332MELA |
| | 30 × 35 | 2780 | 1.54 | LGU1K332MELB |
| | 35 × 30 | 2710 | 1.54 | LGU1K332MELC |
| 3900 | 25 × 50 | 2920 | 1.67 | LGU1K392MELA |
| | 30 × 40 | 3120 | 1.67 | LGU1K392MELB |
| | 35 × 30 | 3070 | 1.67 | LGU1K392MELC |
| 4700 | 30 × 45 | 3520 | 1.83 | LGU1K472MELB |
| | 35 × 35 | 3500 | 1.83 | LGU1K472MELC |
| 5600 | 30 × 50 | 3800 | 2.00 | LGU1K562MELB |
| | 35 × 40 | 3870 | 2.00 | LGU1K562MELC |
| 6800 | 35 × 45 | 4190 | 2.21 | LGU1K682MELC |

| 100V (2A) | | | | |
|-----------|----------------|----------------------|----------------------|--------------|
| Cap. (μF) | Size φD×L (mm) | Rated ripple (mArms) | Leakage Current (mA) | Code |
| 560 | 22 × 25 | 1070 | 0.70 | LGU2A561MELZ |
| 820 | 22 × 30 | 1350 | 0.85 | LGU2A821MELZ |
| | 25 × 25 | 1350 | 0.85 | LGU2A821MELA |
| 1000 | 22 × 30 | 1540 | 0.94 | LGU2A102MELZ |
| | 25 × 30 | 1560 | 0.94 | LGU2A102MELA |
| 1200 | 22 × 40 | 1740 | 1.03 | LGU2A122MELZ |
| | 25 × 30 | 1760 | 1.03 | LGU2A122MELA |
| | 30 × 25 | 1710 | 1.03 | LGU2A122MELB |
| 1500 | 22 × 45 | 1990 | 1.16 | LGU2A152MELZ |
| | 25 × 35 | 2030 | 1.16 | LGU2A152MELA |
| | 30 × 30 | 2000 | 1.16 | LGU2A152MELB |
| 1800 | 25 × 40 | 2280 | 1.27 | LGU2A182MELA |
| | 30 × 35 | 2270 | 1.27 | LGU2A182MELB |
| 2200 | 25 × 50 | 2570 | 1.40 | LGU2A222MELA |
| | 30 × 35 | 2590 | 1.40 | LGU2A222MELB |
| | 35 × 30 | 2520 | 1.40 | LGU2A222MELC |
| 2700 | 30 × 45 | 2940 | 1.55 | LGU2A272MELB |
| | 35 × 35 | 2900 | 1.55 | LGU2A272MELC |
| 3300 | 30 × 50 | 3320 | 1.72 | LGU2A332MELB |
| | 35 × 40 | 3310 | 1.72 | LGU2A332MELC |
| 3900 | 35 × 45 | 3690 | 1.87 | LGU2A392MELC |
| 4700 | 35 × 50 | 4140 | 2.05 | LGU2A472MELC |

| 160V (2C) | | | | |
|-----------|----------------|----------------------|----------------------|--------------|
| Cap. (μF) | Size φD×L (mm) | Rated ripple (mArms) | Leakage Current (mA) | Code |
| 270 | 20 × 25 | 1100 | 0.62 | LGU2C271MELY |
| 330 | 20 × 30 | 1200 | 0.68 | LGU2C331MELY |
| 390 | 20 × 30 | 1300 | 0.74 | LGU2C391MELY |
| | 22 × 25 | 1300 | 0.74 | LGU2C391MELZ |
| 470 | 20 × 35 | 1340 | 0.82 | LGU2C471MELY |
| | 22 × 30 | 1550 | 0.82 | LGU2C471MELZ |
| | 25 × 25 | 1550 | 0.82 | LGU2C471MELA |
| 560 | 20 × 40 | 1500 | 0.89 | LGU2C561MELY |
| | 22 × 35 | 1670 | 0.89 | LGU2C561MELZ |
| | 25 × 30 | 1670 | 0.89 | LGU2C561MELA |
| | 30 × 25 | 1670 | 0.89 | LGU2C561MELB |
| 680 | 20 × 45 | 1700 | 0.98 | LGU2C681MELY |
| | 22 × 40 | 1820 | 0.98 | LGU2C681MELZ |
| | 25 × 30 | 1820 | 0.98 | LGU2C681MELA |
| 820 | 30 × 25 | 1820 | 0.98 | LGU2C681MELB |
| | 22 × 45 | 2040 | 1.08 | LGU2C821MELZ |
| | 25 × 35 | 2040 | 1.08 | LGU2C821MELA |
| | 30 × 30 | 2040 | 1.08 | LGU2C821MELB |
| 1000 | 35 × 25 | 2040 | 1.08 | LGU2C821MELC |
| | 22 × 50 | 2250 | 1.20 | LGU2C102MELZ |
| | 25 × 40 | 2250 | 1.20 | LGU2C102MELA |
| | 30 × 30 | 2250 | 1.20 | LGU2C102MELB |
| 1200 | 35 × 25 | 2250 | 1.20 | LGU2C102MELC |
| | 25 × 45 | 2490 | 1.31 | LGU2C122MELA |
| | 30 × 35 | 2490 | 1.31 | LGU2C122MELB |
| | 35 × 30 | 2490 | 1.31 | LGU2C122MELC |
| 1500 | 30 × 40 | 2840 | 1.46 | LGU2C152MELB |
| | 35 × 30 | 2840 | 1.46 | LGU2C152MELC |
| 1800 | 30 × 45 | 3320 | 1.60 | LGU2C182MELB |
| | 35 × 35 | 3000 | 1.60 | LGU2C182MELC |
| 2200 | 35 × 45 | 3500 | 1.77 | LGU2C222MELC |
| 2700 | 35 × 50 | 4000 | 1.97 | LGU2C272MELC |

Rated ripple current (mArms) at 105°C 120Hz

LGU

■ Dimensions

| 180V (2Z) | | | | |
|-----------|------------------|-------------------------|-------------------------|--------------|
| Cap.(μF) | Size φD×L(mm) | Rated ripple (mArms) | Leakage Current (mA) | Code |
| 220 | 20 × 25 | 1000 | 0.59 | LGU2Z221MELY |
| 270 | 20 × 30 | 1100 | 0.66 | LGU2Z271MELY |
| 330 | 20 × 30 | 1200 | 0.73 | LGU2Z331MELY |
| | 22 × 25 | 1200 | 0.73 | LGU2Z331MELZ |
| 390 | 20 × 35 | 1300 | 0.79 | LGU2Z391MELY |
| | 22 × 30 | 1350 | 0.79 | LGU2Z391MELZ |
| | 25 × 25 | 1350 | 0.79 | LGU2Z391MELA |
| 470 | 20 × 40 | 1400 | 0.87 | LGU2Z471MELY |
| | 22 × 35 | 1500 | 0.87 | LGU2Z471MELZ |
| | 25 × 30 | 1500 | 0.87 | LGU2Z471MELA |
| | 30 × 25 | 1500 | 0.87 | LGU2Z471MELB |
| 560 | 20 × 45 | 1550 | 0.95 | LGU2Z561MELY |
| | 22 × 40 | 1670 | 0.95 | LGU2Z561MELZ |
| | 25 × 30 | 1670 | 0.95 | LGU2Z561MELA |
| | 30 × 25 | 1670 | 0.95 | LGU2Z561MELB |
| 680 | 22 × 45 | 1780 | 1.04 | LGU2Z681MELZ |
| | 25 × 35 | 1780 | 1.04 | LGU2Z681MELA |
| | 30 × 30 | 1780 | 1.04 | LGU2Z681MELB |
| | 35 × 25 | 1780 | 1.04 | LGU2Z681MELC |
| 820 | 22 × 50 | 2040 | 1.15 | LGU2Z821MELZ |
| | 25 × 40 | 2040 | 1.15 | LGU2Z821MELA |
| | 30 × 30 | 2040 | 1.15 | LGU2Z821MELB |
| | 35 × 25 | 2040 | 1.15 | LGU2Z821MELC |
| 1000 | 25 × 45 | 2300 | 1.27 | LGU2Z102MELA |
| | 30 × 35 | 2300 | 1.27 | LGU2Z102MELB |
| | 35 × 30 | 2300 | 1.27 | LGU2Z102MELC |
| 1200 | 25 × 50 | 2550 | 1.39 | LGU2Z122MELA |
| | 30 × 40 | 2550 | 1.39 | LGU2Z122MELB |
| | 35 × 30 | 2550 | 1.39 | LGU2Z122MELC |
| 1500 | 30 × 45 | 2900 | 1.55 | LGU2Z152MELB |
| | 35 × 35 | 2900 | 1.55 | LGU2Z152MELC |
| 1800 | 35 × 45 | 3300 | 1.70 | LGU2Z182MELC |
| 2200 | 35 × 50 | 3650 | 1.88 | LGU2Z222MELC |

| 200V (2D) | | | | |
|-----------|------------------|-------------------------|-------------------------|--------------|
| Cap.(μF) | Size φD×L(mm) | Rated ripple (mArms) | Leakage Current (mA) | Code |
| 220 | 20 × 25 | 1000 | 0.62 | LGU2D221MELY |
| 270 | 20 × 30 | 1100 | 0.69 | LGU2D271MELY |
| | 22 × 25 | 1100 | 0.69 | LGU2D271MELZ |
| 330 | 20 × 35 | 1200 | 0.77 | LGU2D331MELY |
| | 22 × 30 | 1250 | 0.77 | LGU2D331MELZ |
| | 25 × 25 | 1250 | 0.77 | LGU2D331MELA |
| 390 | 20 × 40 | 1310 | 0.83 | LGU2D391MELY |
| | 22 × 30 | 1350 | 0.83 | LGU2D391MELZ |
| | 25 × 25 | 1350 | 0.83 | LGU2D391MELA |
| 470 | 20 × 45 | 1450 | 0.91 | LGU2D471MELY |
| | 22 × 35 | 1500 | 0.91 | LGU2D471MELZ |
| | 25 × 30 | 1500 | 0.91 | LGU2D471MELA |
| | 30 × 25 | 1500 | 0.91 | LGU2D471MELB |
| 560 | 20 × 50 | 1580 | 1.00 | LGU2D561MELY |
| | 22 × 40 | 1670 | 1.00 | LGU2D561MELZ |
| | 25 × 30 | 1670 | 1.00 | LGU2D561MELA |
| | 30 × 25 | 1670 | 1.00 | LGU2D561MELB |
| 680 | 22 × 45 | 1780 | 1.10 | LGU2D681MELZ |
| | 25 × 35 | 1780 | 1.10 | LGU2D681MELA |
| | 30 × 30 | 1780 | 1.10 | LGU2D681MELB |
| | 35 × 25 | 1780 | 1.10 | LGU2D681MELC |
| 820 | 25 × 45 | 2040 | 1.21 | LGU2D821MELA |
| | 30 × 30 | 2040 | 1.21 | LGU2D821MELB |
| | 35 × 25 | 2040 | 1.21 | LGU2D821MELC |
| 1000 | 25 × 50 | 2300 | 1.34 | LGU2D102MELA |
| | 30 × 35 | 2300 | 1.34 | LGU2D102MELB |
| | 35 × 30 | 2300 | 1.34 | LGU2D102MELC |
| 1200 | 30 × 40 | 2650 | 1.46 | LGU2D122MELB |
| | 35 × 35 | 2650 | 1.46 | LGU2D122MELC |
| 1500 | 30 × 50 | 3080 | 1.64 | LGU2D152MELB |
| | 35 × 40 | 3080 | 1.64 | LGU2D152MELC |
| 1800 | 35 × 45 | 3480 | 1.80 | LGU2D182MELC |
| 2200 | 35 × 50 | 3780 | 1.98 | LGU2D222MELC |

| 220V (2P) | | | | |
|-----------|------------------|-------------------------|-------------------------|--------------|
| Cap.(μF) | Size φD×L(mm) | Rated ripple (mArms) | Leakage Current (mA) | Code |
| 180 | 20 × 25 | 900 | 0.59 | LGU2P181MELY |
| 220 | 20 × 30 | 1000 | 0.66 | LGU2P221MELY |
| | 22 × 25 | 1000 | 0.66 | LGU2P221MELZ |
| 270 | 20 × 35 | 1150 | 0.73 | LGU2P271MELY |
| | 22 × 30 | 1150 | 0.73 | LGU2P271MELZ |
| 330 | 20 × 40 | 1250 | 0.80 | LGU2P331MELY |
| | 22 × 35 | 1250 | 0.80 | LGU2P331MELZ |
| | 25 × 25 | 1250 | 0.80 | LGU2P331MELA |
| 390 | 20 × 45 | 1400 | 0.87 | LGU2P391MELY |
| | 22 × 35 | 1400 | 0.87 | LGU2P391MELZ |
| | 25 × 30 | 1400 | 0.87 | LGU2P391MELA |
| 470 | 20 × 50 | 1450 | 0.96 | LGU2P471MELY |
| | 22 × 40 | 1450 | 0.96 | LGU2P471MELZ |
| | 25 × 35 | 1450 | 0.96 | LGU2P471MELA |
| | 30 × 25 | 1450 | 0.96 | LGU2P471MELB |
| 560 | 22 × 45 | 1700 | 1.05 | LGU2P561MELZ |
| | 25 × 40 | 1700 | 1.05 | LGU2P561MELA |
| | 30 × 30 | 1700 | 1.05 | LGU2P561MELB |
| 680 | 25 × 45 | 1780 | 1.16 | LGU2P681MELA |
| | 30 × 35 | 1780 | 1.16 | LGU2P681MELB |
| | 35 × 25 | 1780 | 1.16 | LGU2P681MELC |
| 820 | 25 × 50 | 2100 | 1.27 | LGU2P821MELA |
| | 30 × 40 | 2100 | 1.27 | LGU2P821MELB |
| | 35 × 30 | 2100 | 1.27 | LGU2P821MELC |
| 1000 | 30 × 45 | 2400 | 1.40 | LGU2P102MELB |
| | 35 × 35 | 2400 | 1.40 | LGU2P102MELC |
| 1200 | 30 × 50 | 2600 | 1.54 | LGU2P122MELB |
| | 35 × 40 | 2600 | 1.54 | LGU2P122MELC |
| 1500 | 35 × 45 | 3000 | 1.72 | LGU2P152MELC |

| 250V (2E) | | | | |
|-----------|------------------|-------------------------|-------------------------|--------------|
| Cap.(μF) | Size φD×L(mm) | Rated ripple (mArms) | Leakage Current (mA) | Code |
| 150 | 20 × 25 | 790 | 0.58 | LGU2E151MELY |
| 180 | 20 × 30 | 900 | 0.63 | LGU2E181MELY |
| 220 | 20 × 30 | 1000 | 0.70 | LGU2E221MELY |
| | 22 × 25 | 1000 | 0.70 | LGU2E221MELZ |
| 270 | 20 × 35 | 1100 | 0.77 | LGU2E271MELY |
| | 22 × 35 | 1180 | 0.77 | LGU2E271MELZ |
| | 25 × 25 | 1180 | 0.77 | LGU2E271MELA |
| 330 | 20 × 40 | 1200 | 0.86 | LGU2E331MELY |
| | 22 × 40 | 1300 | 0.86 | LGU2E331MELZ |
| | 25 × 30 | 1300 | 0.86 | LGU2E331MELA |
| | 30 × 25 | 1300 | 0.86 | LGU2E331MELB |
| 390 | 20 × 50 | 1450 | 0.93 | LGU2E391MELY |
| | 22 × 45 | 1490 | 0.93 | LGU2E391MELZ |
| | 25 × 35 | 1490 | 0.93 | LGU2E391MELA |
| 470 | 30 × 25 | 1490 | 0.93 | LGU2E391MELB |
| | 22 × 50 | 1650 | 1.02 | LGU2E471MELZ |
| | 25 × 40 | 1650 | 1.02 | LGU2E471MELA |
| 560 | 30 × 30 | 1650 | 1.02 | LGU2E471MELB |
| | 35 × 25 | 1650 | 1.02 | LGU2E471MELC |
| | 25 × 45 | 1800 | 1.12 | LGU2E561MELA |
| | 30 × 35 | 1800 | 1.12 | LGU2E561MELB |
| 680 | 35 × 25 | 1800 | 1.12 | LGU2E561MELC |
| | 25 × 50 | 2000 | 1.23 | LGU2E681MELA |
| | 30 × 40 | 2000 | 1.23 | LGU2E681MELB |
| 820 | 35 × 30 | 2000 | 1.23 | LGU2E681MELC |
| | 30 × 45 | 2300 | 1.35 | LGU2E821MELB |
| 1000 | 35 × 35 | 2300 | 1.35 | LGU2E821MELC |
| | 30 × 50 | 2470 | 1.50 | LGU2E102MELB |
| 1200 | 35 × 40 | 2470 | 1.50 | LGU2E102MELC |
| | 35 × 45 | 2600 | 1.64 | LGU2E122MELC |
| 1500 | 35 × 50 | 3000 | 1.83 | LGU2E152MELC |

Rated ripple current (mArms) at 105°C 120Hz

CAT.8100M



■ Dimensions

| 315V (2F) | | | | |
|-----------|------------------|-------------------------|-------------------------|--------------|
| Cap.(μF) | Size φD×L(mm) | Rated ripple (mArms) | Leakage Current (mA) | Code |
| 82 | 20 × 25 | 640 | 0.48 | LGU2F820MELY |
| 100 | 20 × 30 | 690 | 0.53 | LGU2F101MELY |
| 120 | 20 × 30 | 750 | 0.58 | LGU2F121MELY |
| | 22 × 25 | 750 | 0.58 | LGU2F121MELZ |
| 150 | 20 × 35 | 820 | 0.65 | LGU2F151MELY |
| | 22 × 30 | 820 | 0.65 | LGU2F151MELZ |
| | 25 × 25 | 820 | 0.65 | LGU2F151MELA |
| 180 | 20 × 40 | 900 | 0.71 | LGU2F181MELY |
| | 22 × 35 | 920 | 0.71 | LGU2F181MELZ |
| | 25 × 25 | 920 | 0.71 | LGU2F181MELA |
| 220 | 20 × 50 | 1000 | 0.78 | LGU2F221MELY |
| | 22 × 40 | 1040 | 0.78 | LGU2F221MELZ |
| | 25 × 30 | 1040 | 0.78 | LGU2F221MELA |
| | 30 × 25 | 1040 | 0.78 | LGU2F221MELB |
| 270 | 22 × 45 | 1160 | 0.87 | LGU2F271MELY |
| | 25 × 35 | 1160 | 0.87 | LGU2F271MELA |
| | 30 × 25 | 1160 | 0.87 | LGU2F271MELB |
| 330 | 22 × 50 | 1330 | 0.96 | LGU2F331MELZ |
| | 25 × 40 | 1330 | 0.96 | LGU2F331MELA |
| | 30 × 30 | 1330 | 0.96 | LGU2F331MELB |
| | 35 × 25 | 1330 | 0.96 | LGU2F331MELC |
| 390 | 25 × 45 | 1470 | 1.05 | LGU2F391MELA |
| | 30 × 35 | 1470 | 1.05 | LGU2F391MELB |
| | 35 × 30 | 1470 | 1.05 | LGU2F391MELC |
| 470 | 25 × 50 | 1700 | 1.15 | LGU2F471MELA |
| | 30 × 40 | 1700 | 1.15 | LGU2F471MELB |
| | 35 × 30 | 1700 | 1.15 | LGU2F471MELC |
| 560 | 30 × 45 | 2050 | 1.26 | LGU2F561MELB |
| | 35 × 35 | 2050 | 1.26 | LGU2F561MELC |
| 680 | 30 × 50 | 2170 | 1.38 | LGU2F681MELB |
| | 35 × 40 | 2170 | 1.38 | LGU2F681MELC |
| 820 | 35 × 45 | 2200 | 1.52 | LGU2F821MELC |

| 400V (2G) | | | | |
|-----------|------------------|-------------------------|-------------------------|--------------|
| Cap.(μF) | Size φD×L(mm) | Rated ripple (mArms) | Leakage Current (mA) | Code |
| 56 | 20 × 25 | 510 | 0.44 | LGU2G560MELY |
| 68 | 20 × 30 | 560 | 0.49 | LGU2G680MELY |
| 82 | 20 × 30 | 640 | 0.54 | LGU2G820MELY |
| | 22 × 25 | 640 | 0.54 | LGU2G820MELZ |
| 100 | 20 × 35 | 700 | 0.60 | LGU2G101MELY |
| | 22 × 30 | 700 | 0.60 | LGU2G101MELZ |
| | 25 × 25 | 700 | 0.60 | LGU2G101MELA |
| 120 | 20 × 40 | 750 | 0.65 | LGU2G121MELY |
| | 22 × 35 | 750 | 0.65 | LGU2G121MELZ |
| | 25 × 25 | 750 | 0.65 | LGU2G121MELA |
| 150 | 20 × 45 | 830 | 0.73 | LGU2G151MELY |
| | 22 × 40 | 880 | 0.73 | LGU2G151MELZ |
| | 25 × 30 | 880 | 0.73 | LGU2G151MELA |
| | 30 × 25 | 880 | 0.73 | LGU2G151MELB |
| 180 | 22 × 45 | 980 | 0.80 | LGU2G181MELZ |
| | 25 × 35 | 980 | 0.80 | LGU2G181MELA |
| | 30 × 30 | 980 | 0.80 | LGU2G181MELB |
| | 35 × 25 | 980 | 0.80 | LGU2G181MELC |
| 220 | 22 × 50 | 1100 | 0.88 | LGU2G221MELZ |
| | 25 × 40 | 1100 | 0.88 | LGU2G221MELA |
| | 30 × 30 | 1100 | 0.88 | LGU2G221MELB |
| | 35 × 25 | 1100 | 0.88 | LGU2G221MELC |
| 270 | 25 × 45 | 1220 | 0.98 | LGU2G271MELA |
| | 30 × 35 | 1220 | 0.98 | LGU2G271MELB |
| | 35 × 30 | 1220 | 0.98 | LGU2G271MELC |
| 330 | 25 × 50 | 1440 | 1.08 | LGU2G331MELA |
| | 30 × 40 | 1440 | 1.08 | LGU2G331MELB |
| | 35 × 30 | 1440 | 1.08 | LGU2G331MELC |
| 390 | 30 × 45 | 1600 | 1.18 | LGU2G391MELB |
| | 35 × 35 | 1600 | 1.18 | LGU2G391MELC |
| 470 | 30 × 50 | 1900 | 1.30 | LGU2G471MELB |
| | 35 × 40 | 1900 | 1.30 | LGU2G471MELC |
| 560 | 35 × 45 | 2120 | 1.41 | LGU2G561MELC |



| 420V (W6) | | | | |
|-----------|------------------|-------------------------|-------------------------|--------------|
| Cap.(μF) | Size φD×L(mm) | Rated ripple (mArms) | Leakage Current (mA) | Code |
| 56 | 20 × 25 | 510 | 0.46 | LGUW6560MELY |
| 68 | 20 × 30 | 560 | 0.50 | LGUW6680MELY |
| 82 | 20 × 35 | 640 | 0.55 | LGUW6820MELY |
| | 22 × 25 | 640 | 0.55 | LGUW6820MELZ |
| 100 | 20 × 35 | 700 | 0.61 | LGUW6101MELY |
| | 22 × 30 | 700 | 0.61 | LGUW6101MELZ |
| | 25 × 25 | 700 | 0.61 | LGUW6101MELA |
| 120 | 20 × 40 | 750 | 0.67 | LGUW6121MELY |
| | 22 × 35 | 750 | 0.67 | LGUW6121MELZ |
| | 25 × 30 | 750 | 0.67 | LGUW6121MELA |
| 150 | 20 × 50 | 880 | 0.75 | LGUW6151MELY |
| | 22 × 40 | 880 | 0.75 | LGUW6151MELZ |
| | 25 × 35 | 880 | 0.75 | LGUW6151MELA |
| | 30 × 25 | 880 | 0.75 | LGUW6151MELB |
| 180 | 22 × 45 | 950 | 0.82 | LGUW6181MELZ |
| | 25 × 35 | 950 | 0.82 | LGUW6181MELA |
| | 30 × 30 | 950 | 0.82 | LGUW6181MELB |
| 220 | 22 × 50 | 1100 | 0.91 | LGUW6221MELZ |
| | 25 × 45 | 1100 | 0.91 | LGUW6221MELA |
| | 30 × 35 | 1100 | 0.91 | LGUW6221MELB |
| | 35 × 25 | 1100 | 0.91 | LGUW6221MELC |
| 270 | 25 × 50 | 1220 | 1.01 | LGUW6271MELA |
| | 30 × 40 | 1220 | 1.01 | LGUW6271MELB |
| | 35 × 30 | 1220 | 1.01 | LGUW6271MELC |
| 330 | 30 × 45 | 1450 | 1.11 | LGUW6331MELB |
| | 35 × 35 | 1450 | 1.11 | LGUW6331MELC |
| 390 | 30 × 50 | 1550 | 1.21 | LGUW6391MELB |
| | 35 × 40 | 1550 | 1.21 | LGUW6391MELC |
| 470 | 35 × 45 | 1900 | 1.33 | LGUW6471MELC |
| 560 | 35 × 50 | 2150 | 1.45 | LGUW6561MELC |

| 450V (2W) | | | | |
|-----------|------------------|-------------------------|-------------------------|--------------|
| Cap.(μF) | Size φD×L(mm) | Rated ripple (mArms) | Leakage Current (mA) | Code |
| 47 | 20 × 25 | 390 | 0.43 | LGU2W470MELY |
| 56 | 20 × 30 | 510 | 0.47 | LGU2W560MELY |
| 68 | 20 × 35 | 560 | 0.52 | LGU2W680MELY |
| | 20 × 35 | 640 | 0.57 | LGU2W820MELY |
| 82 | 22 × 30 | 640 | 0.57 | LGU2W820MELZ |
| | 25 × 25 | 640 | 0.57 | LGU2W820MELA |
| | 20 × 45 | 690 | 0.63 | LGU2W101MELY |
| 100 | 22 × 35 | 690 | 0.63 | LGU2W101MELZ |
| | 25 × 30 | 690 | 0.63 | LGU2W101MELA |
| | 20 × 50 | 750 | 0.69 | LGU2W121MELY |
| 120 | 22 × 40 | 800 | 0.69 | LGU2W121MELZ |
| | 25 × 30 | 800 | 0.69 | LGU2W121MELA |
| | 30 × 25 | 800 | 0.69 | LGU2W121MELB |
| | 22 × 45 | 880 | 0.77 | LGU2W151MELZ |
| 150 | 25 × 35 | 880 | 0.77 | LGU2W151MELA |
| | 30 × 30 | 880 | 0.77 | LGU2W151MELB |
| | 22 × 50 | 1000 | 0.85 | LGU2W181MELZ |
| 180 | 25 × 40 | 1000 | 0.85 | LGU2W181MELA |
| | 30 × 30 | 1000 | 0.85 | LGU2W181MELB |
| | 25 × 45 | 1120 | 0.94 | LGU2W221MELA |
| 220 | 30 × 35 | 1120 | 0.94 | LGU2W221MELB |
| | 35 × 30 | 1120 | 0.94 | LGU2W221MELC |
| 270 | 30 × 40 | 1280 | 1.04 | LGU2W271MELB |
| | 35 × 35 | 1280 | 1.04 | LGU2W271MELC |
| 330 | 30 × 50 | 1450 | 1.15 | LGU2W331MELB |
| | 35 × 40 | 1450 | 1.15 | LGU2W331MELC |
| 390 | 35 × 40 | 1500 | 1.25 | LGU2W391MELC |
| 470 | 35 × 50 | 1850 | 1.37 | LGU2W471MELC |







Rated ripple current (mArms) at 105°C 120Hz

Looking for pricing, stock, or lifecycle information?

Click below to explore more details on WIN SOURCE:

-  [View LGU1V153MELC on WIN SOURCE](#)
-  [Nichicon Information](#)

Optimize Your Supply Chain with WIN SOURCE Solutions

-  Global Sourcing Solution
-  Obsolete Management
-  Cost Control Management
-  Shortage Management
-  Alternative Solution
-  Excess Inventory Management