



**THE DATASHEET OF  
TL59CF100Q**





# SERIES TL59/TL58 SWITCHES

## TACT SWITCHES RADIAL LEAD

TACT SWITCHES

NAVIGATION SWITCHES

PUSHBUTTON SWITCHES

TOGGLE SWITCHES

ROCKER SWITCHES

SLIDE SWITCHES

SNAP-ACTION SWITCHES

DIP SWITCHES

KEYLOCK SWITCHES

ROTARY SWITCHES

DETECTOR SWITCHES

CAP. OPTIONS

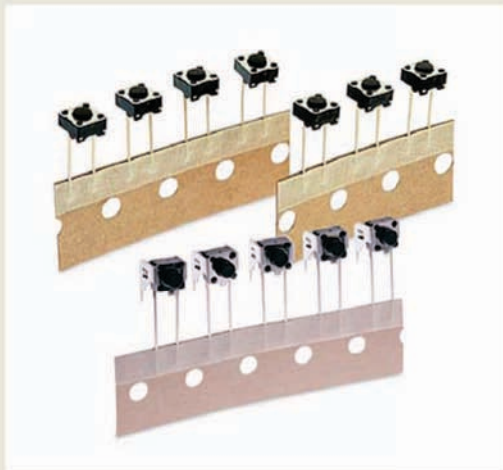

### SPECIFICATIONS

Contact Rating:	50mA @ 12 VDC
Life Expectancy:	100,000 cycles
Contact Resistance:	100mΩ max., typical @ 2-4 VDC 100mA for both silver plated contacts
Insulation Resistance:	100MΩ min.
Dielectric Strength:	250 VAC
Actuation Force:	100 ± 50 gf, 160 ± 50 gf, 260 ± 50 gf
Operating Temperature:	-20°C to 70°C
Travel:	0.25 Typ

### FEATURES & BENEFITS

- ▶ Designed for automatic feed
- ▶ Radial lead packaging

### APPLICATIONS/MARKETS

- ▶ Telecommunications
- ▶ Consumer Electronics
- ▶ Audio/visual
- ▶ Medical
- ▶ Testing/instrumentation
- ▶ Computer/servers/peripherals

### HOW TO ORDER

SERIES	MODEL NO.	ACTUATOR ("L" Dimension)	OPERATING FORCE	CONTACT MATERIAL
TL	59	N = 4.3mm A = 5.0mm B = 9.5mm C = 8.0mm F = 7.0mm E = 7.3mm P = 8.5mm SP = 2.8mm <input type="checkbox"/>	F100 F160 F260	Q = Silver

- Square Snap-on Actuator Head  
"L" Dimension is 7.5mm

TL	58 Right Angle	V = 3.85mm W = 3.15mm X = 4.75mm	F100 F160 F260	Q = Silver
----	-------------------	--	----------------------	------------

▶ ▶ ▶ Example Ordering Number  
 TL-59-N-F160-Q

Specifications subject to change without notice.



### TL 59

#### STANDARD RADIAL LEAD

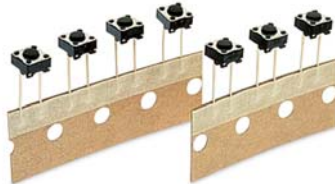

Actuator Length (L) in mm		
N = 4.3	C = 8.0	P = 8.5
A = 5.0	F = 7.0	SP = 2.8 □
B = 9.5	E = 7.3	

Operating Force	
F100	= 100 ± 50gf
F160	= 160 ± 50gf
F260	= 260 ± 50gf

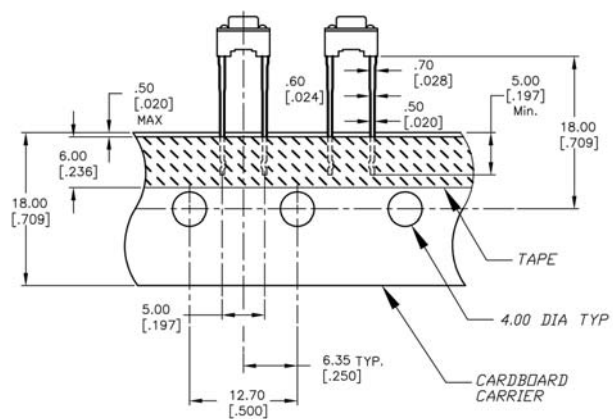
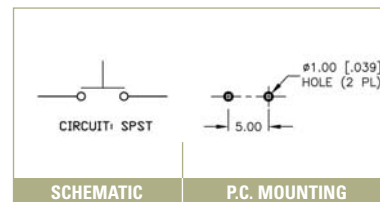
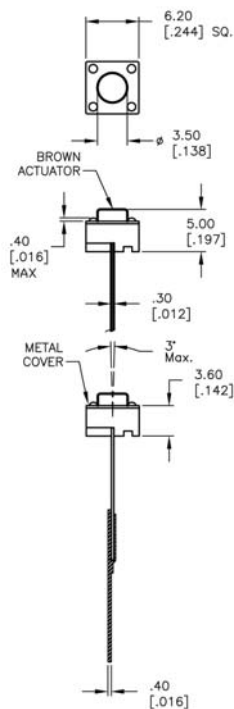

### TL 58

#### RIGHT ANGLE RADIAL LEAD

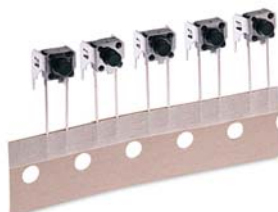

Actuator Length (L) in mm	
V	= 3.85
W	= 3.15
X	= 4.75

Operating Force	
F100	= 100 ± 50gf
F160	= 160 ± 50gf
F260	= 260 ± 50gf

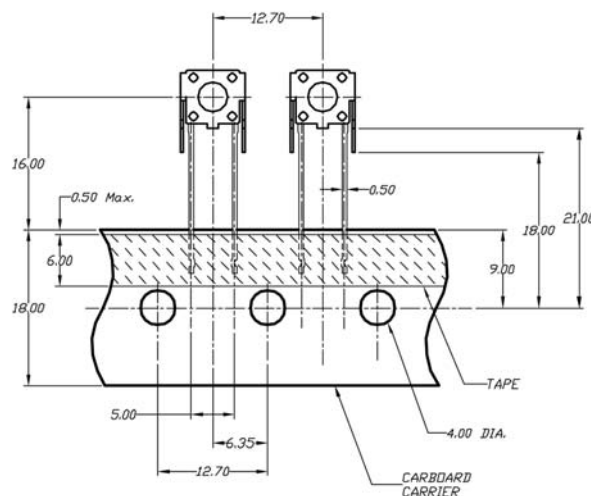
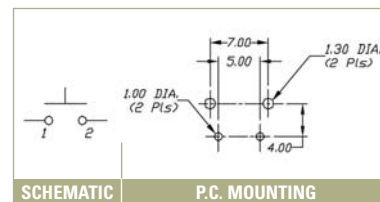
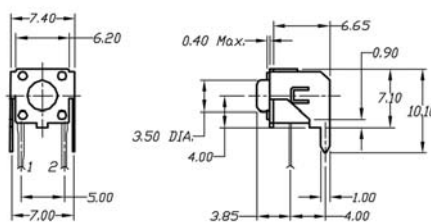

TACT SWITCHES

NAVIGATION SWITCHES

PUSHBUTTON SWITCHES

TOGGLE SWITCHES

ROCKER SWITCHES

SLIDE SWITCHES

SNAP-ACTION SWITCHES

DIP SWITCHES

KEYLOCK SWITCHES



ROTARY SWITCHES

DETECTOR SWITCHES





CAP OPTIONS

## Looking for pricing, stock, or lifecycle information?

Click below to explore more details on WIN SOURCE:

-  [View TL59CF100Q on WIN SOURCE](#)
-  [E-Switch Information](#)

## Optimize Your Supply Chain with WIN SOURCE Solutions

-  Global Sourcing Solution
-  Obsolete Management
-  Cost Control Management
-  Shortage Management
-  Alternative Solution
-  Excess Inventory Management