



**THE DATASHEET OF
QSB35048S48**



QSB Series



- Wide Input Range
- Industry Standard Packages
- -40 °C to +100 °C Operating Temperature
- High Power Density
- Base Plate Cooled
- Remote On/Off & Remote Sense
- 3 Year Warranty

Specification

Input

Input Voltage Range	• See tables
Input Current	• See tables
Input Reverse Voltage Protection	• None
Input Filter	• Pi network
Undervoltage Lockout	• QSB75-150: 24 Vin - turn on 8.8 V, turn off 8.0 V for 9-36 V, QSB200: 24 Vin - turn on 9.6 V, turn off 8.8 V, QSB75-200: 48 Vin - turn on 17.0 V, turn off 16.0 V, QSB350: 24 Vin - turn on 17.0 V, turn off 16.0 V, QSB350: 48 Vin - turn on 35.0 V, turn off 33.0 V
Input Surge	• 24 Vin: 50 VDC for 100 ms 48 Vin: 100 VDC for 100 ms

Output

Output Voltage Trim	• $\pm 10\%$, see application notes
Initial Set Accuracy	• $\pm 1.5\%$ max
Line Regulation	• $\pm 0.2\%$ max measured from high line to low line
Load Regulation	• $\pm 0.2\%$ max measured from 0-100% load
Transient Response	• 5% max deviation, recovery to within 1% in 500 μ s, 25% step load change
Ripple & Noise	• 3.3 & 5 V models: 100 mV pk-pk 12 & 15 V models: 150 mV pk-pk 24 V & 28 V models: 280 mV max pk-pk 20 MHz bandwidth (see note 1)
Overvoltage Protection	• 115-140%
Short Circuit Protection	• Continuous
Thermal Shutdown	• Case temperature > 105 °C
Temperature Coefficient	• $\pm 0.03\%/^{\circ}\text{C}$
Current Limit	• 110-140% nominal output for 75 & 150 W 110-160% nominal output for 100 W 110-150% nominal output for 200 W 105-140% nominal output for 350 W
Remote On/Off	• See notes 2 & 3
Remote Sense	• Compensates up to 10% of Vout nominal, total of output trim and remote sense

General

Efficiency	• See tables
Isolation Voltage	• 1500 VDC Input to Output 1500 VDC Input to Case 1500 VDC Output to Case
Isolation Resistance	• $10^7 \Omega$
Isolation Capacitance	• QSB75-200: 100 pF typical, QSB350: 1000 pF typical
Switching Frequency	• QSB75: 300 kHz typical QSB100, 150 & 200: 250 kHz typical QSB350 (3V3 & 5 V): 300 kHz typical QSB350 (12, 24 & 28 V): 330 kHz typical
Power Density	• QSB75: 45.4 W/in ³ , QSB100: 60.5 W/in ³ , QSB150: 57.2 W/in ³ , QSB200: 70.3 W/in ³ , QSB350: 123.0 W/in ³
MTBF	• QSB75 & 100: 730 kHrs QSB150 & 200: 1 MHrs QSB350: 658 kHrs typical to MIL-HDBK-217F at 25 °C, GB

Environmental

Operating Base Plate Temperature	• -40 °C to +100 °C, see derating curves
Storage Temperature	• -55 °C to +105 °C
Operating Humidity	• Up to 90% non-condensing
Cooling	• Base plate cooled, see derating curves

EMC & Safety

Emissions	• EN55022, level A conducted with external components, see test reports for further details
ESD Immunity	• EN61000-4-2, level 2, Perf Criteria B
Radiated Immunity	• EN61000-4-3, 3 V/m, Perf Criteria A
EFT/Burst	• EN61000-4-4, level 1, Perf Criteria A
Surge	• EN61000-4-5, level 1, Perf Criteria A
Conducted Immunity	• EN61000-4-6, 3 V rms Perf Criteria A
Safety Approvals	• UL60950-1

Models and Ratings

QSB75/100 XP

Input Voltage	Output Voltage	Output Current	Input Current ⁽⁴⁾		Efficiency	Model Number ⁽³⁾
			No Load	Full Load		
9-36 VDC (24 V nominal)	3.3 V	12.00 A	50 mA	2.04 A	81.0%	QSB7524S3V3
	5.0 V	12.00 A	50 mA	2.98 A	84.0%	QSB7524S05
	12.0 V	6.25 A	50 mA	3.64 A	86.0%	QSB7524S12
	15.0 V	5.00 A	50 mA	3.64 A	86.0%	QSB7524S15
	24.0 V	3.12 A	50 mA	3.63 A	86.0%	QSB7524S24
18-75 VDC (48 V nominal)	3.3 V	12.00 A	30 mA	1.10 A	82.0%	QSB7548S3V3
	5.0 V	12.00 A	30 mA	1.47 A	85.0%	QSB7548S05
	12.0 V	6.25 A	30 mA	1.82 A	86.0%	QSB7548S12
	15.0 V	5.00 A	30 mA	1.80 A	87.0%	QSB7548S15
	24.0 V	3.12 A	30 mA	1.80 A	87.0%	QSB7548S24
9-36 VDC (24 V nominal)	3.3 V	30.00 A	120 mA	4.80 A	86.0%	QSB10024S3V3
	5.0 V	20.00 A	120 mA	4.82 A	86.5%	QSB10024S05
	12.0 V	8.30 A	80 mA	4.80 A	86.5%	QSB10024S12
	15.0 V	6.70 A	80 mA	4.84 A	86.5%	QSB10024S15
	24.0 V	4.17 A	80 mA	4.79 A	87.0%	QSB10024S24
18-75 VDC (48 V nominal)	3.3 V	30.00 A	60 mA	2.37 A	88.0%	QSB10048S3V3
	5.0 V	20.00 A	60 mA	2.37 A	88.0%	QSB10048S05
	12.0 V	8.30 A	30 mA	2.36 A	88.0%	QSB10048S12
	15.0 V	6.70 A	30 mA	2.38 A	88.0%	QSB10048S15
	24.0 V	4.17 A	30 mA	2.37 A	88.0%	QSB10048S24

Notes

- Ripple & noise is measured with a 10 μ F tantalum capacitor and 1.0 μ F ceramic capacitor across output.
- Logic compatibility: Ref to -ve input. Module On = open circuit. Module Off = <0.8 VDC.
- Add suffix 'N' to the model number to receive the unit with negative logic Remote On/Off.
- Input current specified at 24 V for 9-36 VDC and 48 V for 18-75 VDC models.

Mechanical Details

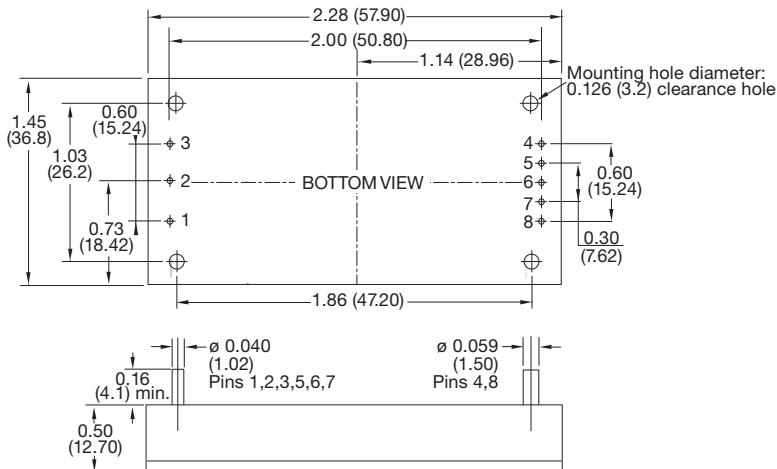

PIN CONNECTIONS	
Pin	Function
1	+Vin
2	Remote On/Off
3	-Vin
4	-Vout
5	-Sense
6	Trim
7	+Sense
8	+Vout

Notes

- Dimensions are in inches (mm)
- Tolerances: X.XX = ± 0.02 (X.X = ± 0.5)
X.XXX = ± 0.01 (X.XX = ± 0.25)
- Weight: 0.15 lbs (66 g) approx

Thermal Resistance Information

Derating Curve

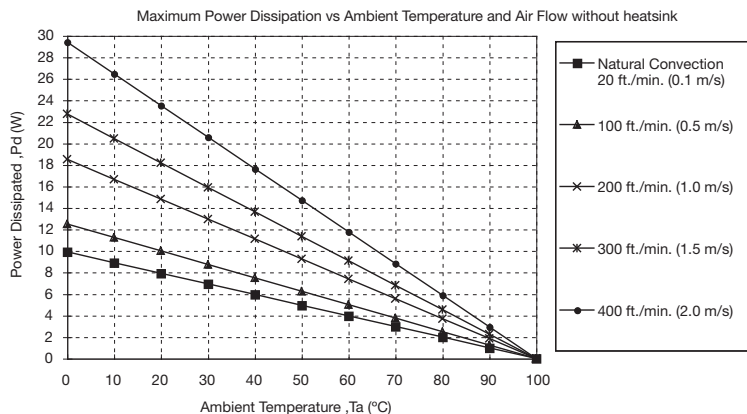

Air Flow Rate	Typical R _{ca}
Natural Convection 20 ft. / min (0.1 ms)	10.1 °C/W
100 ft./min (0.5 ms)	8.0 °C/W
200 ft./min (1.0 ms)	5.4 °C/W
300 ft./min (1.5 ms)	4.4 °C/W
400 ft./min (2.0 ms)	3.4 °C/W

R_{ca} = Thermal resistance case to ambient



Models & Ratings

Input Voltage	Output Voltage	Output Current	Input Current ⁽⁴⁾		Efficiency	Model Number ⁽³⁾
			No Load	Full Load		
9-36 VDC (24 V nominal)	3.3 V	30.00 A	200 mA	4.75 A	87.0%	QSB15024S3V3
	5.0 V	30.00 A	200 mA	7.19 A	87.0%	QSB15024S05
	12.0 V	12.50 A	100 mA	7.10 A	88.0%	QSB15024S12
	15.0 V	10.00 A	100 mA	7.19 A	87.0%	QSB15024S15
	24.0 V	6.50 A	100 mA	7.34 A	88.0%	QSB15024S24
18-75 VDC (48 V nominal)	3.3 V	30.00 A	100 mA	2.34 A	88.0%	QSB15048S3V3
	5.0 V	30.00 A	100 mA	3.47 A	90.0%	QSB15048S05
	12.0 V	12.50 A	50 mA	3.44 A	91.0%	QSB15048S12
	15.0 V	10.00 A	50 mA	3.47 A	90.0%	QSB15048S15
	24.0 V	6.50 A	50 mA	3.61 A	90.0%	QSB15048S24
10-36 VDC (24 V nominal)	3.3 V	50.00 A	150 mA	7.90 A	87.0%	QSB20024S3V3
	5.0 V	40.00 A	150 mA	9.58 A	87.0%	QSB20024S05
	12.0 V	16.70 A	100 mA	9.71 A	86.0%	QSB20024S12
	15.0 V	13.30 A	100 mA	9.67 A	86.0%	QSB20024S15
	24.0 V	8.30 A	100 mA	9.54 A	87.0%	QSB20024S24
	48.0 V	4.20 A	60 mA	9.77 A	86.0%	QSB20024S48
18-75 VDC (48 V nominal)	3.3 V	40.00 A	80 mA	3.13 A	88.0%	QSB20048S3V3
	5.0 V	40.00 A	80 mA	4.69 A	89.0%	QSB20048S05
	12.0 V	16.70 A	60 mA	4.74 A	88.0%	QSB20048S12
	15.0 V	13.30 A	60 mA	4.72 A	88.0%	QSB20048S15
	24.0 V	8.30 A	60 mA	7.72 A	88.0%	QSB20048S24
	48.0 V	4.20 A	50 mA	4.83 A	87.0%	QSB20048S48
18-36 VDC (24 V nominal)	3.3 V	70.0 A	130 mA	10.94 A	88.0 %	QSB35024S3V3
	5.0 V	70.0 A	250 mA	16.29 A	89.5 %	QSB35024S05
	12.0 V	29.2 A	220 mA	15.96 A	91.5%	QSB35024S12
	24.0 V	14.6 A	40 mA	16.22 A	90.0%	QSB35024S24
	28.0 V	12.5 A	50 mA	16.03 A	91.0%	QSB35024S28 ⁽⁶⁾
	48.0 V	7.3 A	60 mA	16.22 A	90.0%	QSB35024S48 ⁽⁶⁾
36-75 VDC (48 V nominal)	3.3 V	70.0 A	80 mA	5.41 A	89.0%	QSB35048S3V3
	5.0 V	70.0 A	120 mA	8.01 A	91.0%	QSB35048S05
	12.0 V	29.2 A	100 mA	7.89 A	92.5%	QSB35048S12
	24.0 V	14.6 A	40 mA	7.98 A	91.5%	QSB35048S24
	28.0 V	12.5 A	30 mA	7.88 A	92.5%	QSB35048S28 ⁽⁶⁾
	48.0 V	7.3 A	60 mA	7.93 A	92.0%	QSB35048S48 ⁽⁶⁾

Notes

- Ripple & noise is measured with a 10 μF tantalum capacitor and 1.0 μF ceramic capacitor across output.
- Logic compatibility: Ref to -ve input. Module On = open circuit. Module Off = <0.8 VDC.
- Add suffix 'N' to the model number to receive the unit with negative logic Remote On/Off.
- Input current specified at 24 V for 10-36 VDC models and 48 V for 18-75 VDC models.
- Add an external capacitor of 100 μF minimum to the output terminals, in order to maintain the specified regulation.

Mechanical Details

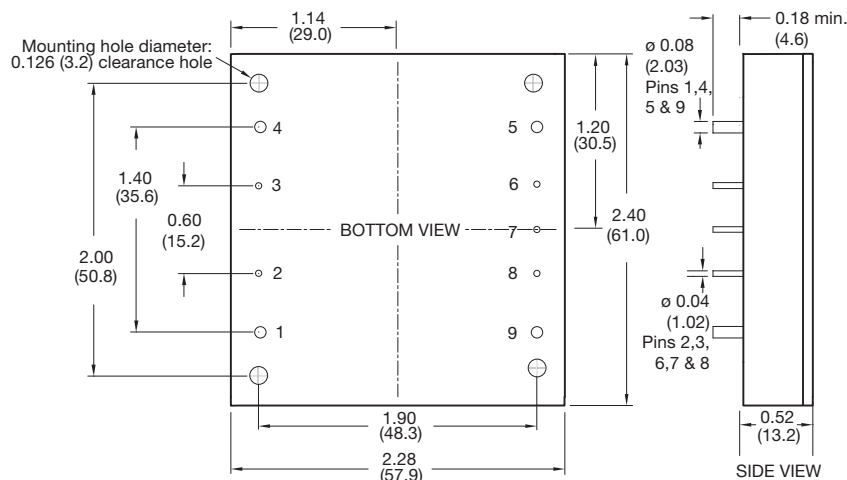

PIN CONNECTIONS	
Pin	Function
1	+Vin
2	Remote On/Off
3	Case
4	-Vin
5	-Vout
6	-Sense
7	Trim
8	+Sense
9	+Vout

Notes

- Dimensions are in inches (mm)
- Tolerances: X.XX = ±0.02 (X.X = ±0.5)
X.XXX = ±0.01 (X.XX = ±0.25)
- Weight: 0.25 lbs (114 g) approx



Derating Curve

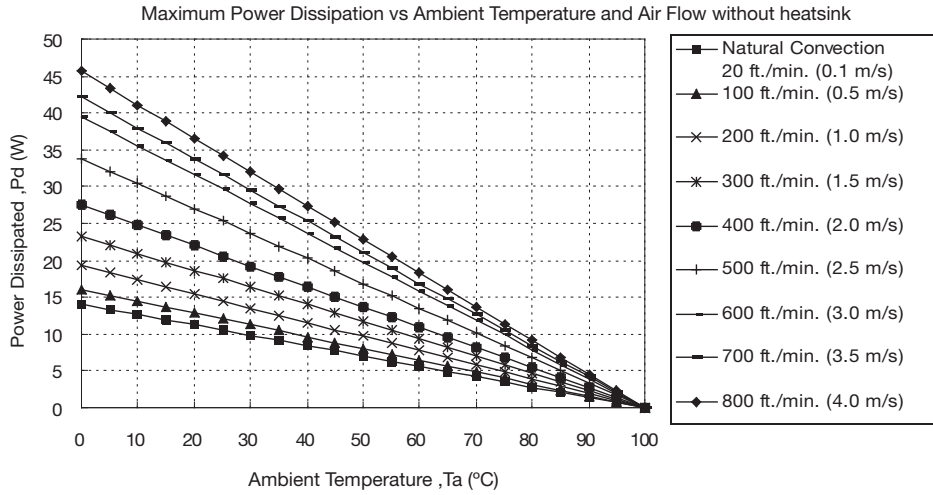

Air Flow Rate	Typical R _{ca}
Natural Convection	7.12 °C/W
20 ft./min (0.1 ms)	6.21 °C/W
100 ft./min (0.5 ms)	5.17 °C/W
200 ft./min (1.0 ms)	4.29 °C/W
300 ft./min (1.5 ms)	3.64 °C/W
400 ft./min (2.0 ms)	2.96 °C/W
500 ft./min (2.5 ms)	2.53 °C/W
600 ft./min (3.0 ms)	2.37 °C/W
700 ft./min (3.5 ms)	2.37 °C/W
800 ft./min (4.0 ms)	2.19 °C/W

R_{ca} = Thermal resistance case to ambient

Application Notes

Output Voltage Trim - QSB75 & QSB150 Series

Voltage trim up

Connect trim resistor R_{trim} between Trim pin and -Sense pin.

$$R \text{ trim up} = \left(\frac{R1 \left(Vr - Vf \left(\frac{R2}{R2 + R3} \right) \right)}{Vdes - Vnom} \right) - \frac{R2 \times R3}{R2 + R3} \text{ (k}\Omega\text{)}$$

Voltage trim down

Connect trim resistor R_{trim} between Trim pin and +Sense pin

$$R \text{ trim down} = \frac{R1 \times (Vdes - Vr)}{Vnom - Vdes} - R2 \text{ (k}\Omega\text{)}$$

Where: R trim up/down is the external resistor in kΩ. Vnom is the nominal output voltage. Vdes is the desired output voltage. R1, R2, R3 and Vr are internal to the unit and are defined in the table below.

Output Voltage (V)	R1 (kΩ)	R2 (kΩ)	R3 (kΩ)	Vr (V)	Vf (V)
3.3V	3.00	12.0	4.3	1.24	0.46
5.0V	2.32	3.3	0.0	2.5	0.0
12.0V	9.10	51.0	5.1	2.5	0.46
15.0V	12.0	56.0	8.25	2.5	0.46
24.0V	20.0	100.0	7.5	2.5	0.46

Output Voltage Trim - QSB100, QSB200 & QSB350 Series

Voltage trim down - Connect trim resistor R_{trim} between Trim pin and -Sense pin

$$R \text{ trim down} = \left(\frac{511}{\Delta\%} - 10.22 \right) \text{ k}\Omega$$

For Vo: 48 V

$$R \text{ trim down} = \left(\frac{200}{\Delta\%} - 40 \right) \text{ k}\Omega$$

Where: $\Delta\% = \left(\frac{Vnom - Vdes}{Vnom} \right) \times 100$

Voltage trim up - Voltage trim up, Connect trim resistor R_{trim} between Trim pin and +Sense pin.

$$R \text{ trim up} = \left(\frac{5.11 Vnom (100 + \Delta\%)}{1.225 \times \Delta\%} - \frac{511}{\Delta\%} - 10.22 \right) \text{ k}\Omega$$

For Vo: 48 V

$$R \text{ trim up} = \left(\frac{20 Vnom (100 + \Delta\%)}{1.225 \times \Delta\%} - \frac{2000}{\Delta\%} - 40 \right) \text{ k}\Omega$$

Where: $\Delta\% = \left(\frac{Vdes - Vnom}{Vnom} \right) \times 100$

Value	QSB100/200	QSB350
k	1.225	1.24







Looking for pricing, stock, or lifecycle information?

Click below to explore more details on WIN SOURCE:

 [View QSB35048S48](#) on WIN SOURCE

 [XP Power](#) Information

Optimize Your Supply Chain with WIN SOURCE Solutions

-  Global Sourcing Solution
-  Obsolete Management
-  Cost Control Management
-  Shortage Management
-  Alternative Solution
-  Excess Inventory Management