



**THE DATASHEET OF  
IMM0512S05**



### 5 Watts

- Regulated Single & Dual Outputs from 3.3 VDC to  $\pm 15$  VDC
- World Wide Medical Certification
- 2:1 Input Range
- Ultra Compact SIP9 Package
- 1500 VAC Isolation
- 1 x MOPP at 250VAC
- Remote On/Off
- -20 °C to +100 °C Operation
- Full Load to +60 °C
- 3 Year Warranty

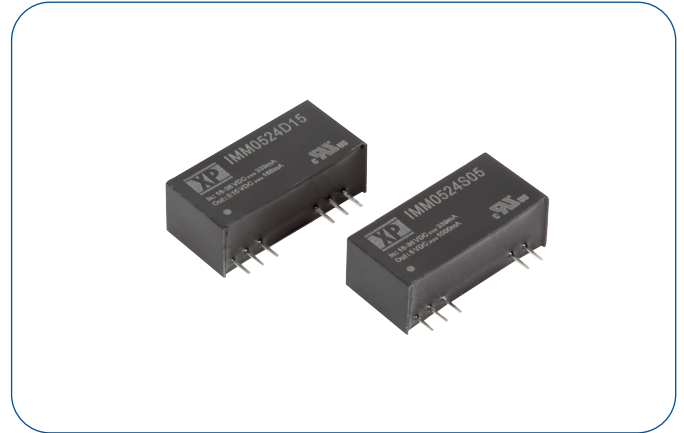

#### Dimensions:

##### IMM05:

1.02 x 0.36 x 0.49" (26.0 x 9.3 x 12.5 mm)

The IMM05 series of dc-dc converter offers an ultra compact 5W solution facilitating an isolation barrier between input and output with low leakage current required for medical BF & CF applications.

### Models & Ratings

Input Voltage VDC	Output Voltage VDC	Output Current mA	Input current		Maximum capacitive load $\mu$ F	Model Number
			No Load	Full Load		
5V (4.5-9.0V)	3.3V	1200 mA	105 mA	1100 mA	2200 $\mu$ F	IMM0505S3V3
	5.0V	1000 mA	105 mA	1372 mA	1000 $\mu$ F	IMM0505S05
	12.0V	416 mA	105 mA	1353 mA	470 $\mu$ F	IMM0505S12
	15.0V	333 mA	105 mA	1354 mA	330 $\mu$ F	IMM0505S15
	$\pm 12.0$ V	$\pm 208$ mA	105 mA	1387 mA	$\pm 220$ $\mu$ F	IMM0505D12
	$\pm 15.0$ V	$\pm 166$ mA	105 mA	1383 mA	$\pm 168$ $\mu$ F	IMM0505D15
12V (9.0-18.0V)	3.3V	1200 mA	55 mA	550 mA	2200 $\mu$ F	IMM0512S3V3
	5.0V	1000 mA	55 mA	678 mA	1000 $\mu$ F	IMM0512S05
	12.0V	416 mA	55 mA	676 mA	470 $\mu$ F	IMM0512S12
	15.0V	333 mA	55 mA	677 mA	330 $\mu$ F	IMM0512S15
	$\pm 12.0$ V	$\pm 208$ mA	55 mA	676 mA	$\pm 220$ $\mu$ F	IMM0512D12
	$\pm 15.0$ V	$\pm 166$ mA	55 mA	675 mA	$\pm 168$ $\mu$ F	IMM0512D15
24V (18.0-36.0V)	3.3V	1200 mA	30 mA	275 mA	2200 $\mu$ F	IMM0524S3V3
	5.0V	1000 mA	30 mA	339 mA	1000 $\mu$ F	IMM0524S05
	12.0V	416 mA	30 mA	334 mA	470 $\mu$ F	IMM0524S12
	15.0V	333 mA	30 mA	334 mA	330 $\mu$ F	IMM0524S15
	$\pm 12.0$ V	$\pm 208$ mA	30 mA	338 mA	$\pm 220$ $\mu$ F	IMM0524D12
	$\pm 15.0$ V	$\pm 166$ mA	30 mA	337 mA	$\pm 168$ $\mu$ F	IMM0524D15

### Notes

Full load input current measured at minimum input voltage.

### Mechanical Details

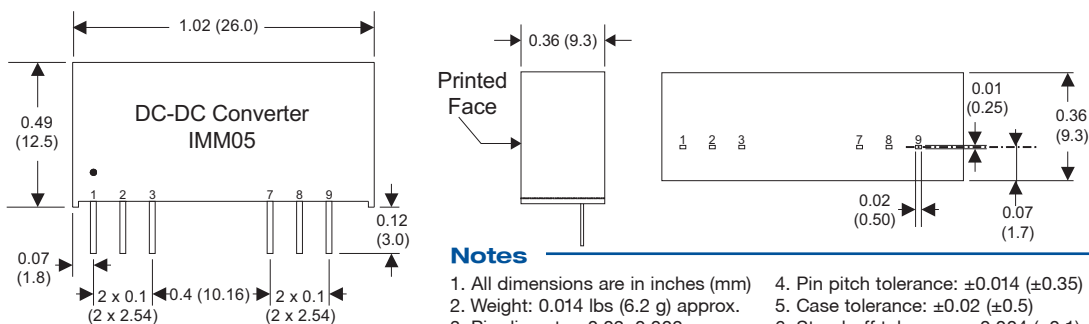

#### Notes

1. All dimensions are in inches (mm)
2. Weight: 0.014 lbs (6.2 g) approx.
3. Pin diameter: 0.02 $\pm$ 0.002 (0.5 $\pm$ 0.05)
4. Pin pitch tolerance:  $\pm 0.014$  ( $\pm 0.35$ )
5. Case tolerance:  $\pm 0.02$  ( $\pm 0.5$ )
6. Stand-off tolerance:  $\pm 0.004$  ( $\pm 0.1$ )

Pin Connections		
Pin	Single	Dual
1	+Vin	+Vin
2	-Vin	-Vin
3	Remote On/Off	Remote On/Off
7	No Pin	-Vout
8	-Vout	Common
9	+Vout	+Vout

### Input

Characteristic	Minimum	Typical	Maximum	Units	Notes & Conditions
Input Voltage Range	4.5		9	VDC	5 V nominal
	9		18		12 V nominal
	18		36		24 V nominal
Inrush Current		3.5		A	5 V nominal
		1.5			12 V nominal
		0.7			24 V nominal
Input Reflected Ripple Current		30		mA pk-pk	Through 12 $\mu$ H inductor and 47 $\mu$ F capacitor
Input Surge			15	VDC for 100 ms	5 V nominal
			25		12 V nominal
			50		24 V nominal
Input Current Remote On/Off		2.5		mA	Idle current at $V_{in}$ nominal

### Output

Characteristic	Minimum	Typical	Maximum	Units	Notes & Conditions
Output Voltage	3.3		30	VDC	See Models and Ratings table
Initial Set Accuracy			$\pm 2$	%	At full load
Minimum Load	0			%	No minimum load required
Line Regulation			$\pm 0.5$	%	From min to max input voltage
Load Regulation			$\pm 2.0$	%	From 0-100% load
Cross Regulation			$\pm 5$	%	On dual output models, when one output is at 25% load and other is varied from 10% load to full load
Transient Response Deviation			4	%	Deviation recovering to within 1% in 500 $\mu$ s for 25% load change at 0.1 A/ $\mu$ s
Ripple & Noise			75	mV, pk-pk	20 MHz bandwidth. Measured using 0.1 $\mu$ F ceramic capacitor
Short Circuit Protection					Continuous fold-back mode, with auto recovery
Maximum Capacitive Load					See Models and Ratings table
Temperature Coefficient			0.03	%/ $^{\circ}$ C	
Overload Protection		140		%	Of nominal output current at nominal input voltage
Remote On/Off	Output is on if remote on/off (pin 3) is open Output turns off if 2-4 mA is applied to remote on/off (pin 3). See application note.				

### General

Characteristic	Minimum	Typical	Maximum	Units	Notes & Conditions
Efficiency		82		%	
Isolation: Input to Output	1500			VAC	At 250 VAC working voltage, basic insulation, 1 x MOPP, 60 s
Switching Frequency	177		1300	kHz	
Isolation Resistance	$10^9$			$\Omega$	
Isolation Capacitance			27	pF	
Leakage Current			2	$\mu$ A	
Power Density			28	W/in <sup>3</sup>	
Mean Time Between Failure	630			KHrs	MIL-HDBK-217F, +25 $^{\circ}$ C GB
Weight		0.014 (6.2)		lb (g)	
Case Material	Non conductive black plastic				
Potting Material	Epoxy (UL94V-0 rated)				
Pin Material	C5191R-H matte tin coated				
Solder Process			260	$^{\circ}$ C	Waveflow. 0.05" (1.5mm) from case, 10 seconds max.

### Environmental

Characteristic	Minimum	Typical	Maximum	Units	Notes & Conditions
Operating Temperature	-20		+100	$^{\circ}$ C	Derate from 100% load at +60 $^{\circ}$ C to 50% at +80 $^{\circ}$ C
Storage Temperature	-40		+125	$^{\circ}$ C	
Case Temperature			+105	$^{\circ}$ C	
Humidity Op and Store	5		95	%RH	Non-condensing
Cooling					Natural convection
Altitude			5000	m	Transport altitude 10 km
Temperature Coefficient		$\pm 0.03$		%/ $^{\circ}$ C	

### EMC: Emissions

Phenomenon	Standard	Test Level	Notes & Conditions
Conducted	EN55011	Class B	See Application Note
Radiated	EN55011	Class B	

### EMC: Immunity

Phenomenon	Standard	Test Level	Criteria	Notes & Conditions
Medical Device EMC	EN60601-1-2	2015		
ESD Immunity	EN61000-4-2	±15 kV	A	Air Discharge
Radiated Immunity	EN61000-4-3	10 Vrms	A	
EFT/Burst	EN61000-4-4	2 kV	A	External input filter required, see applications note
Surge	EN61000-4-5	2 kV	A	External input filter required, see applications note
Conducted Immunity	EN61000-4-6	10 V rms	A	
Magnetic Fields	EN61000-4-8	30 A/m	A	

### Safety Approvals

Safety Agency	Safety Standard	Notes & Conditions
UL	ANSI/AMMI ES60601-1	
CSA	CSA C22.2 No. 60601-1	
TUV	EN60601-1	
CB	IEC/EN60601-1	
CE	Meets all applicable directives	
UKCA	Meets all applicable legislation	

### Application Note

#### External Filter for Surge and EFT

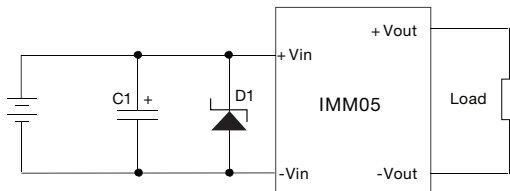

Model	C1	D1
IMM0505	220 $\mu$ F/100 V	TVS, 16 V, 3 kW
IMM0512	220 $\mu$ F/100 V	TVS, 26 V, 3 kW
IMM0524	220 $\mu$ F/100 V	TVS, 51 V, 3 kW

#### EMI Filter Conducted Emissions

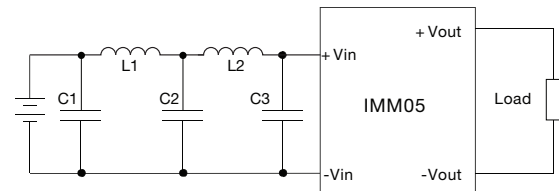

Model	C1	C2	C3	L1	L2
IMM0505	1210, 22 $\mu$ F/25 V	1210, 22 $\mu$ F/25 V	1210, 22 $\mu$ F/25 V	10 $\mu$ H	10 $\mu$ H
IMM0512	2220, 22 $\mu$ F/50 V	2220, 22 $\mu$ F/50 V		12 $\mu$ H	12 $\mu$ H
IMM0524	2220, 22 $\mu$ F/50 V	2220, 22 $\mu$ F/50 V		22 $\mu$ H	22 $\mu$ H

#### Remote On/Off

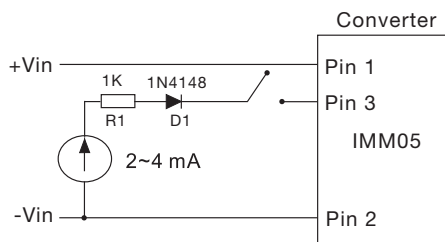

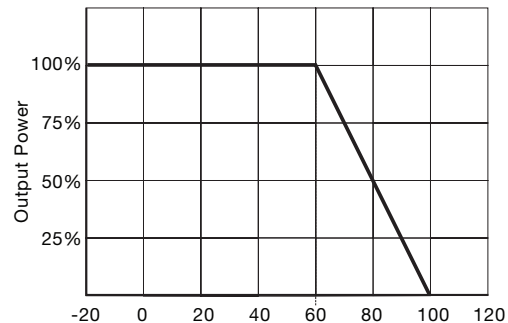

#### Derating Curve









## Looking for pricing, stock, or lifecycle information?

Click below to explore more details on WIN SOURCE:

-  [View IMM0512S05 on WIN SOURCE](#)
-  [XP Power Information](#)

## Optimize Your Supply Chain with WIN SOURCE Solutions

-  Global Sourcing Solution
-  Obsolete Management
-  Cost Control Management
-  Shortage Management
-  Alternative Solution
-  Excess Inventory Management