



**THE DATASHEET OF  
SST-10-UV-A130-G385-00**



# SST-10-UV

## Surface Mount LED

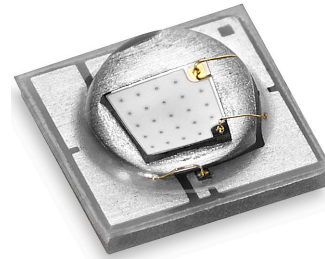

### Features

- High Power UV LED with peak wavelengths 365 nm, 385 nm, 395 nm, 405 nm and 415 nm
- Industry standard 3.5 mm x 3.5 mm package
- 130° viewing angle
- Low Thermal Resistance : 1.4 °C/W
- Built-in ESD Protection
- Environmentally friendly: REACH, RoHS and Halogen compliant



### Applications

- Curing- inks, coating and adhesives
- Photocatalytic air/water purification
- Medical and Analytic instrumentation
- Diagnostics
- Fluorescence Imaging
- Antimicrobial surface disinfection

### Table of Contents

Ordering Information. ....	2
Binning Structure. ....	3
Absolute Maximum Ratings . . . . .	4
Device Characteristics . . . . .	5
Angular Distribution and Typical Spectrum. ....	8
Soldering Profile. ....	9
Mechanical Dimensions. ....	10
Tape and Reel Outline . . . . .	12
Shipping Label . . . . .	13
Notes . . . . .	14
Revision History . . . . .	15



## Ordering Information

### Ordering Part Numbers<sup>1</sup>

Color	Wavelength Range (nm)	Luminous Flux		Wavelength Bins	Solder Pad	Ordering Part Number
		Min. Flux Bin	Min. Flux			
UV	365-375	F	810 mW	365, 370	A	SST-10-UV-A130-F365-00
					B	SST-10-UV-B130-F365-00
		G	900 mW		A	SST-10-UV-A130-G365-00
					B	SST-10-UV-B130-G365-00
	380-390	G	900 mW	380, 385	A	SST-10-UV-A130-G385-00
					B	SST-10-UV-B130-G385-00
		H	990 mW		A	SST-10-UV-A130-H385-00
					B	SST-10-UV-B130-H385-00
	390-400	G	900 mW	390, 395	A	SST-10-UV-A130-G395-00
					B	SST-10-UV-B130-G395-00
		H	990 mW		A	SST-10-UV-A130-H395-00
					B	SST-10-UV-B130-H395-00
	400-410	G	900 mW	400, 405	A	SST-10-UV-A130-G405-00
					B	SST-10-UV-B130-G405-00
	410-420	G	900 mW	410, 415	A	SST-10-UV-A130-G415-00
					B	SST-10-UV-B130-G415-00

### Part Number Nomenclature

SST

10

UV

X130

<FWWW-00>

Product Family	Chip Area	Color	Package Configuration <sup>1</sup>	Bin Kit <sup>2,3</sup>
SST: Surface Mount package	10: 1 mm <sup>2</sup>	UV: Ultraviolet	A130: "A" solder pad layout and 130° lens B130: "B" solder pad layout and 130° lens	Refer to ordering part numbers in this document

**Note:**

1. Refer to drawings on page 10 & 11 for details on "A" and "B" solder pad layouts.
2. A Bin Kit represents a group of flux and wavelength bins that are shippable for a given ordering part number. Individual bins are not orderable.
3. Flux Bin listed is minimum bin shipped - higher bins may be included at Luminus' discretion.



## Binning Structure

SST-10-UV LEDs are specified for flux peak wavelength and voltage at a drive current of 500 mA with a 20 ms pulse at 25°C and placed into one of the following Flux, Peak Wavelength and Forward Voltage Bins.

### Flux Bins

Color	Power Flux Bin (F)	Minimum Flux (mW)	Maximum Flux (mW)
UV	F	810	900
	G	900	990
	H	990	1080
	I	1080	1170
	J	1170	1260
	K	1260	1350

### Peak Wavelength Bins

Color	Wavelength Bin (WWW)	Minimum Wavelength (nm)	Maximum Wavelength (nm)
UV	365	365	370
	370	370	375
	380	380	385
	385	385	390
	390	390	395
	395	395	400
	400	400	405
	405	405	410
	410	410	415
	415	415	420

### Forward Voltage Bins

Color	Voltage Bin	Minimum Voltage (V)	Maximum Voltage (V)
UV	V0	2.8	3.0
	V1	3.0	3.2
	V2	3.2	3.4
	V3	3.4	3.6
	V4	3.6	3.8
	V5	3.8	4.0

**Note:**

1. Luminus maintains a +/- 6% tolerance on flux measurements.



## Absolute Maximum Ratings

	Symbol	Values	Unit
Absolute Maximum Forward Current (CW)	$I_{f365}$	1	A
	$I_{f385-415}$	1.5	
Storage Temperature	$T_{smin}$	-40	°C
	$T_{smax}$	100	
Junction Temperature	$T_{jmax}$	100	°C
ESD sensitivity ANSI/ESDA/JEDEC JS-001 (HBM, Class 2)	$V_{ESD}$	6000	V

**Note:**

1. For reference only.
2. SST-10-UV LEDs are designed for operation to an absolute maximum current as specified above. Product lifetime data is specified at or below maximum drive current. Sustained operation beyond absolute maximum currents will result in a reduction of device life time . Actual device lifetimes will also depend on junction temperature and operation beyond maximum junction temperature is not recommended. Contact Luminus for lifetime derating curves and for further information. In pulsed operation, rise time from 10-90% of forward current should be longer than 0.5 μseconds.



## Device Characteristics<sup>1</sup>

Optical and Electrical Characteristics	Symbol	Value					Unit
Emitting Area	$A_E$	1.0					mm <sup>2</sup>
Test Drive Current	$I_f$	500					mA
Viewing Angle	$2\Phi_{1/2}$	130					degree
Peak Wavelength Range	$\lambda$	365-375	380-390	390-400	400-410	410-415	nm
Peak Wavelength (Typ)	$\lambda_p$	370	385	395	405	415	nm
Forward Voltage	$V_{f\ min}$	2.8	2.8	2.8	2.8	2.8	V
	$V_f$	3.7	3.4	3.3	3.3	3.2	
	$V_{f\ max}$	4.0	4.0	4.0	4.0	4.0	
Peak Radiometric Flux <sup>2</sup>	$\Phi_E$	875	1015	1015	930	930	mW
FWHM- Spectral bandwidth at 50% of $\Phi_V$	$\Delta\lambda_{1/2}$	10	10	10	10	10	nm

**Note:**

- While SST-10-UV devices are tested at 500 mA, they can be driven at CW currents ranging from 200 mA to 1.5 A and at duty cycles ranging from 1% to 100%. Drive current and duty cycle should be adjusted as necessary to maintain the junction temperature desired to meet application lifetime requirements..
- Typical radiometric flux is for reference only. Minimum flux values are guaranteed based on the bin kit ordered. For product roadmap and future performance of devices, contact Luminus.



### Relative Radiometric Flux - 365 nm/385 nm/395 nm/405 nm

Forward current:  $\phi_v/\phi_v(500\text{ mA}), T_c = 25^\circ\text{C}$

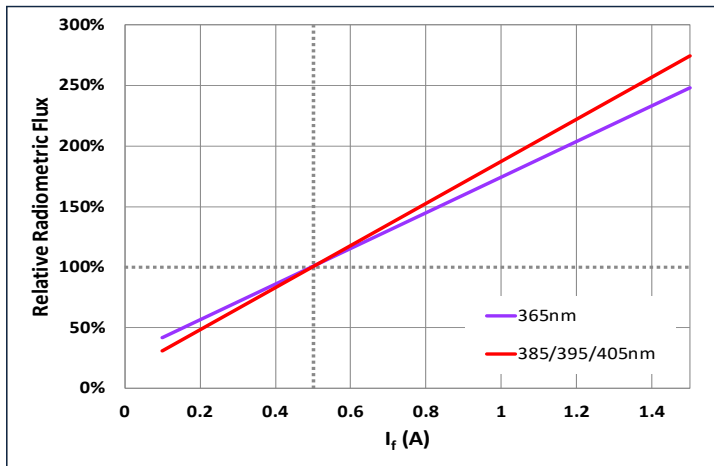

Temperature:  $\phi_v/\phi_v(25^\circ\text{C}), I_f = 500\text{ mA}$

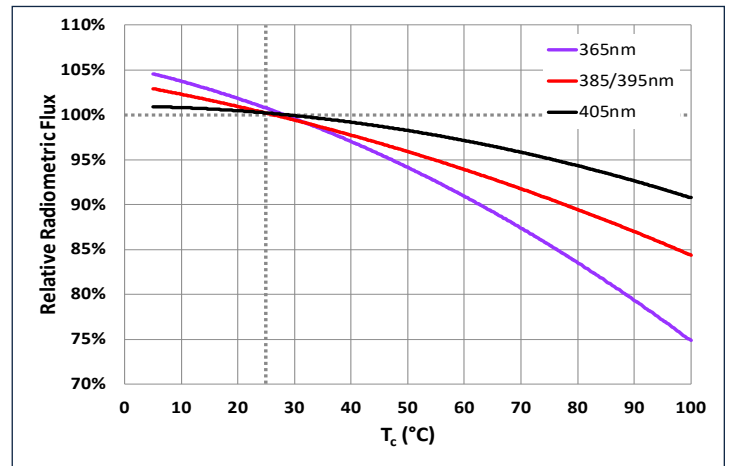

### Forward Voltage - 365 nm/385 nm/395 nm/405 nm

Forward current:  $V_f = V(I_f), T_c = 25^\circ\text{C}$

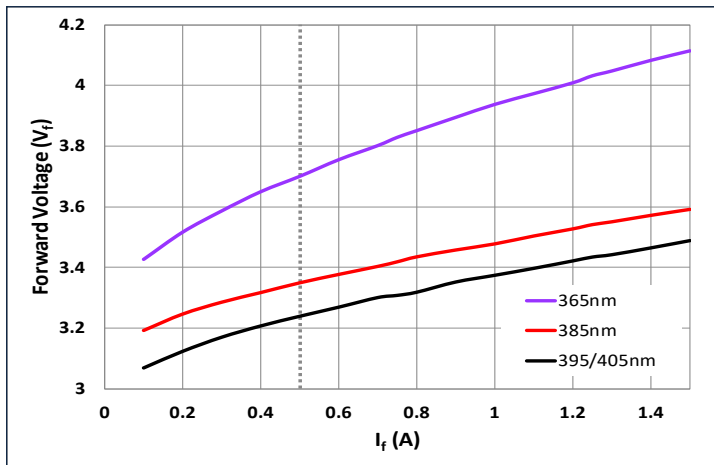

Temperature:  $\Delta V_f = V(T_c) - V(25^\circ\text{C}), I_f = 500\text{ mA}$

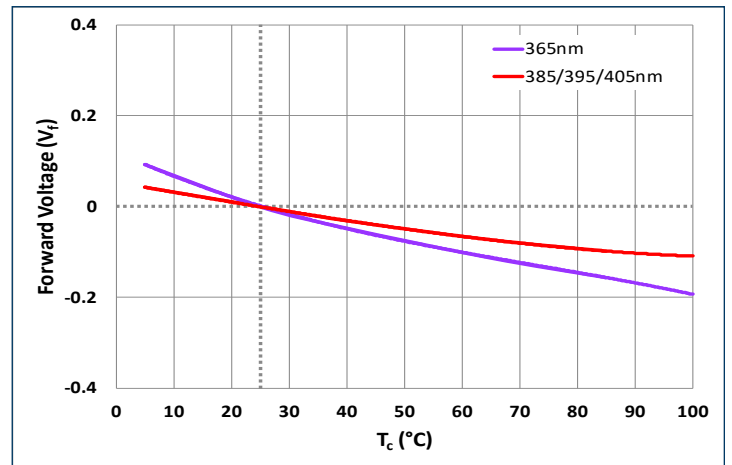

### Peak Wavelength Shift - 365 nm/385 nm/395 nm/405 nm

Forward current:  $\Delta\lambda_p = \lambda_p(I_f) - \lambda_p(500\text{ mA}), T_c = 25^\circ\text{C}$

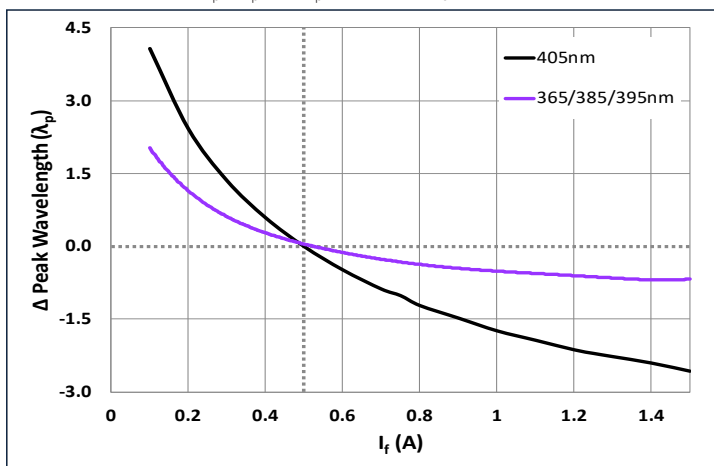

Temperature:  $\Delta\lambda_p = \lambda_p(T_c) - \lambda_p(25^\circ\text{C}), I_f = 500\text{ mA}$

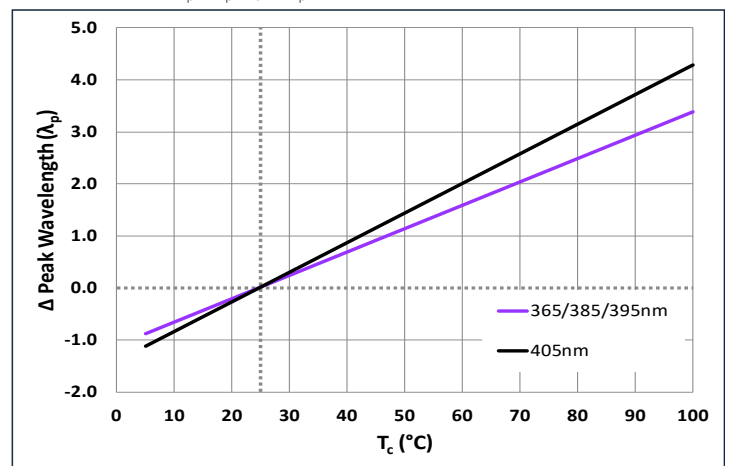



### Relative Radiometric Flux - 415 nm

Forward current:  $\phi_v/\phi_v(500\text{ mA}), T_c = 25^\circ\text{C}$

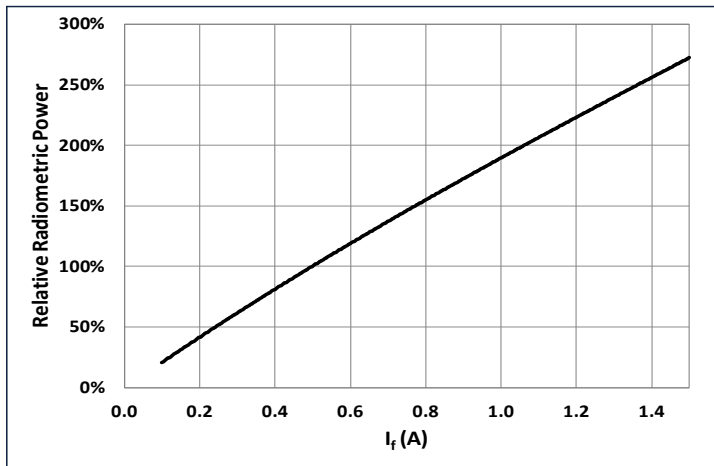

Temperature:  $\phi_v/\phi_v(25^\circ\text{C}), I_f = 500\text{ mA}$

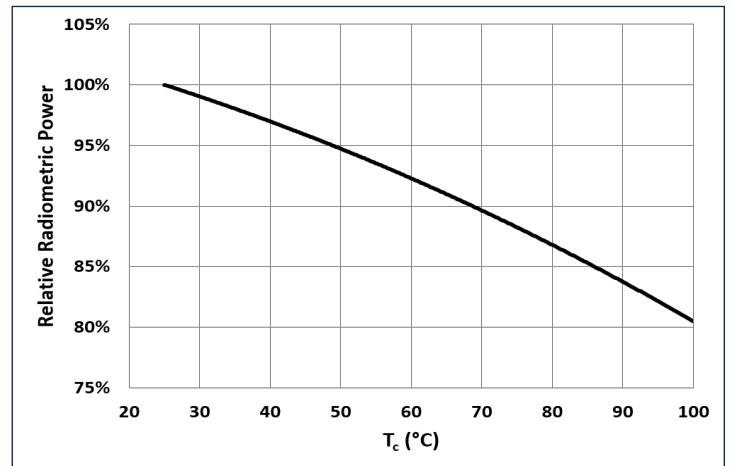

### Forward Voltage - 415 nm

Forward current:  $V_f = V(I_f), T_c = 25^\circ\text{C}$

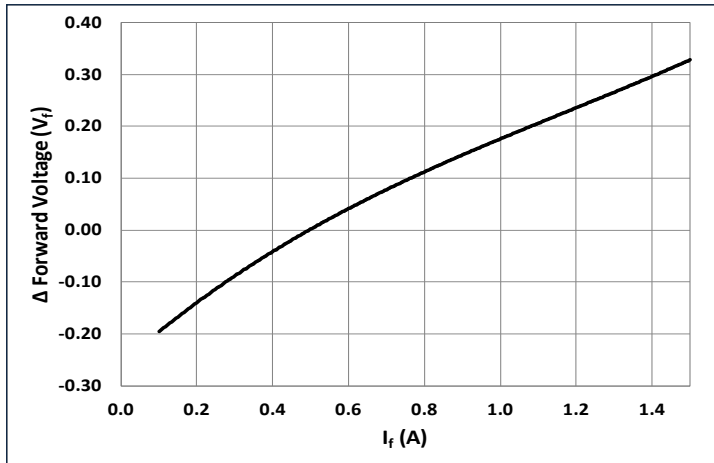

Temperature:  $\Delta V_f = V(T_c) - V(25^\circ\text{C}), I_f = 500\text{ mA}$

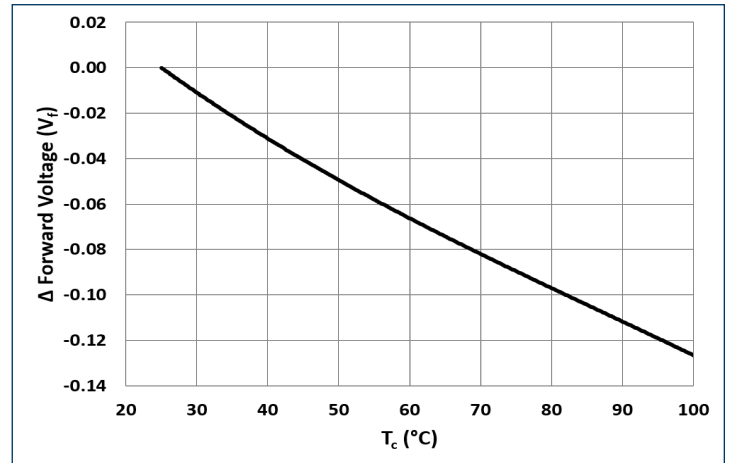

### Peak Wavelength Shift - 415 nm

Forward current:  $\Delta\lambda_p = \lambda_p(I_f) - \lambda_p(500\text{ mA}), T_c = 25^\circ\text{C}$

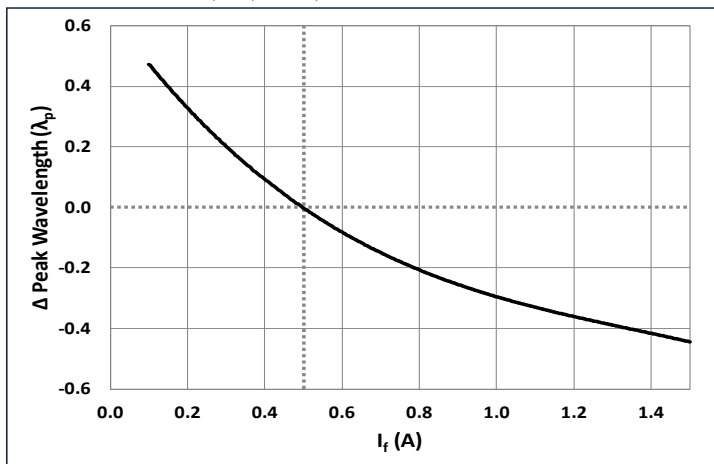

Temperature:  $\Delta\lambda_p = \lambda_p(T_c) - \lambda_p(25^\circ\text{C}), I_f = 500\text{ mA}$

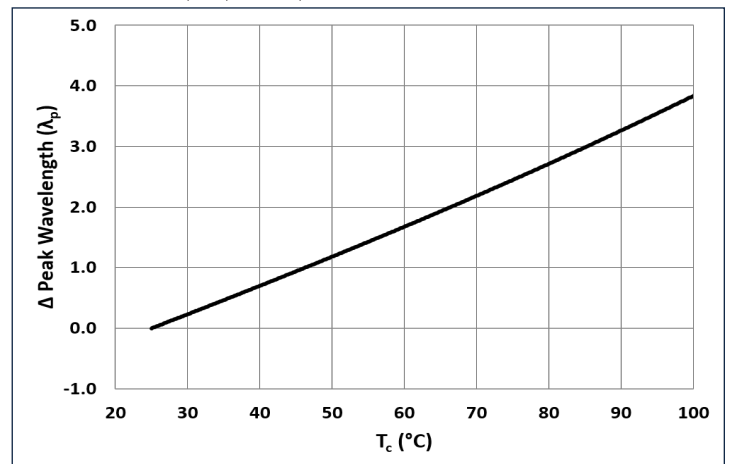



## Angular Distribution and Typical Spectrum

### Angular Intensity Distribution

$$I_{\text{ref}} = f(\Phi); T_c = 25^\circ\text{C}$$

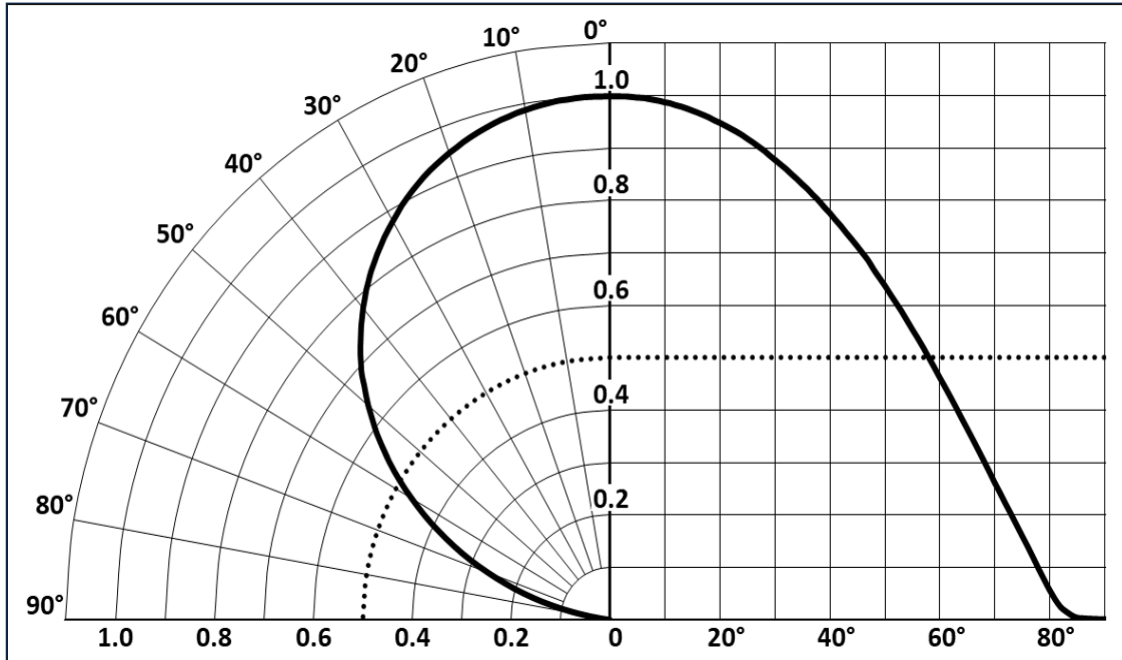

### Typical Spectrum

$$\Phi_{\text{ref}} = f(\lambda); I_f = 500 \text{ mA}; T_c = 25^\circ\text{C}$$

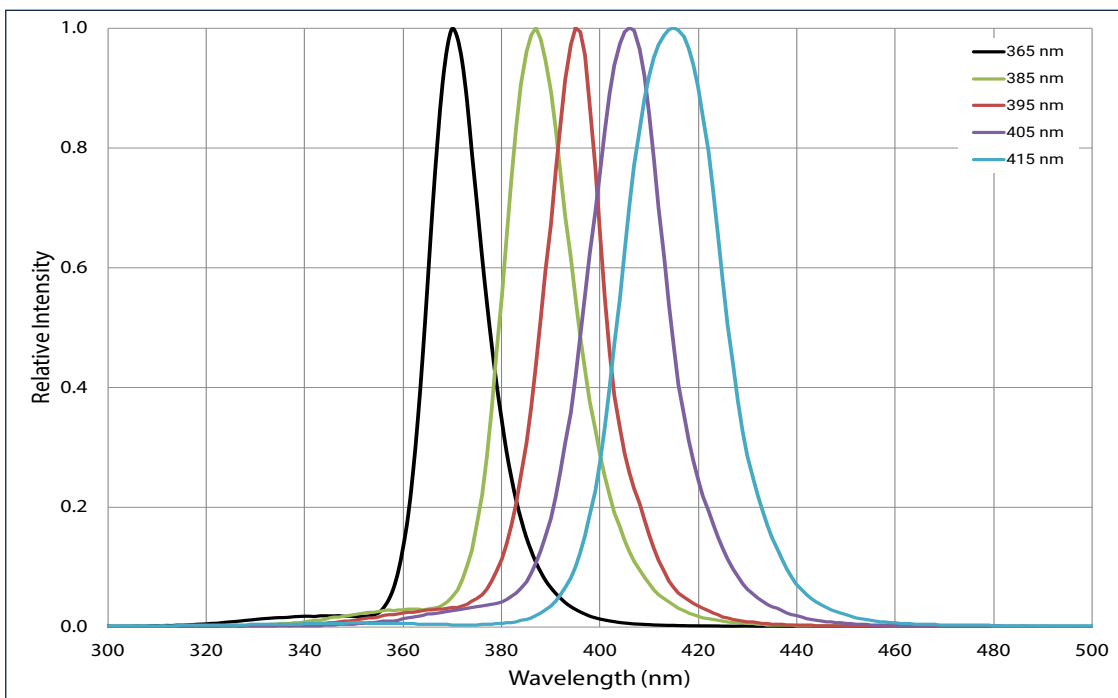



## Soldering Profile

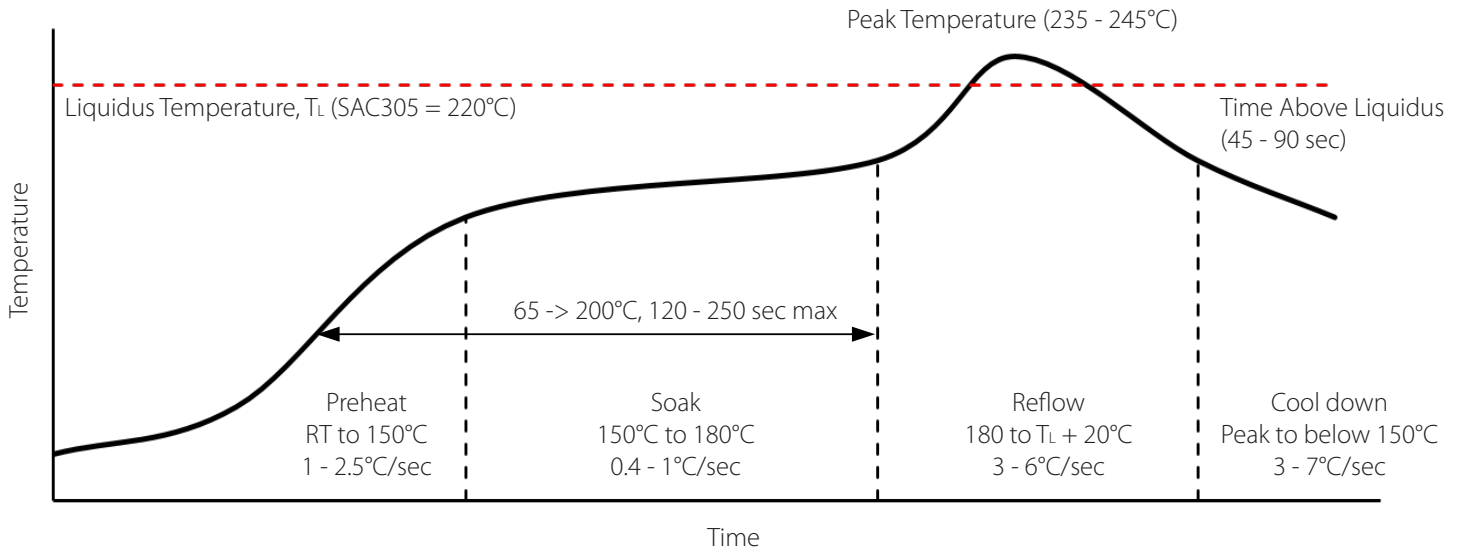

SMT Rework Guideline	Manual Hotplate Reflow	Hot Air Gun Reflow
Heating Time	< 60 sec	
Hotplate Temperature	< 245°C	< 150°C

**Note:**

- Product complies to Moisture Sensitivity Level 1 (MSL 1).
- The numbers in the table are specific to SAC305. Luminus recommends using an SAC305 solder paste with a no-clean flux for RoHS compliant products.
- During the pick and place process, axial forces on the dome (or window) should not exceed 0.5 Newtons (N).
- Use of a multi-zone IR reflow oven with a nitrogen blanket is recommended.
- Time-temperature profile of the reflow process showing the four functional profile zones are defined in IPC-7801. Temperature is referenced to the center of the PCB.
- Luminus recommends to use the solder paste data sheet information as a starting point in time-temperature process development.
- These are general guidelines. Consult the solder paste manufacturer's datasheet for guidelines specific to the alloy and flux combination used in your application.  
For more information, please refer to:  
<https://luminusdevices.zendesk.com/hc/en-us/articles/360060306692-How-do-I-Reflow-Solder-Luminus-SMD-Components->
- For any technical questions about soldering process, please contact Luminus at techsupport@luminus.com.



## Mechanical Dimensions - A130 package

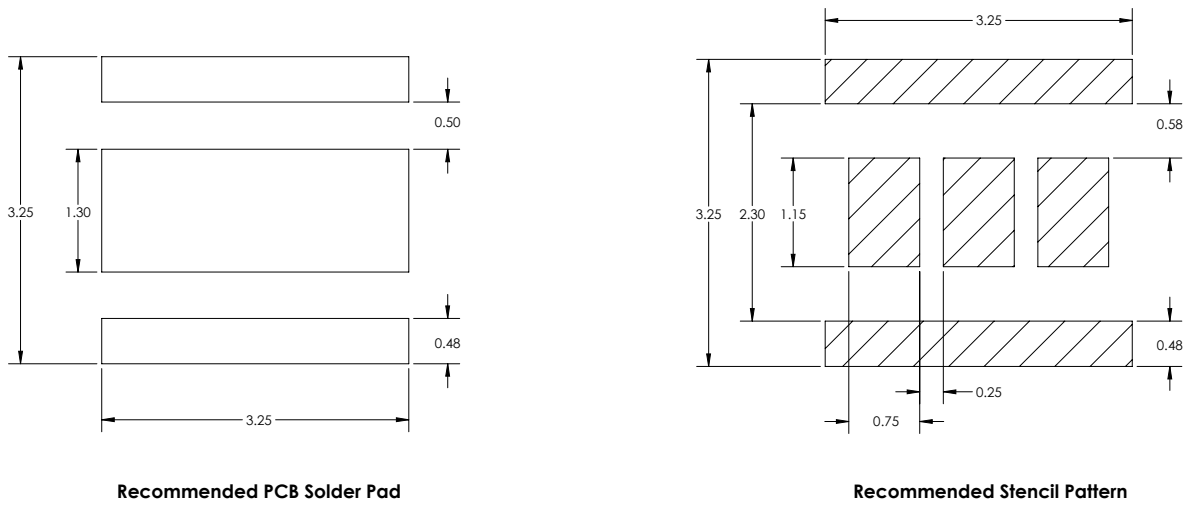
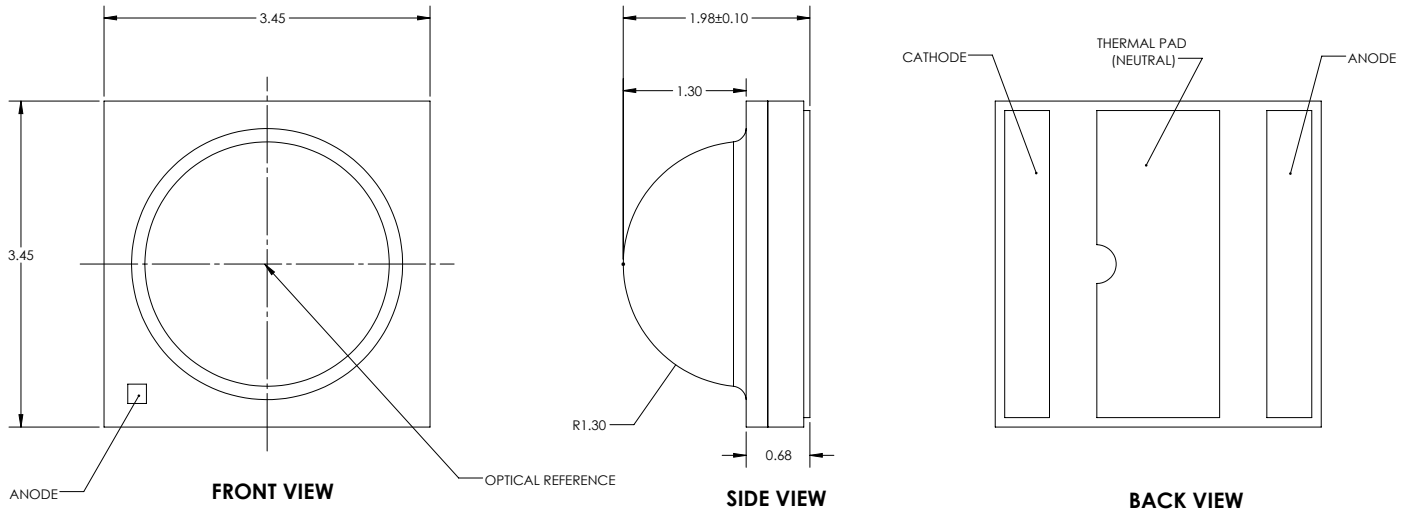



## Mechanical Dimensions - B130 package

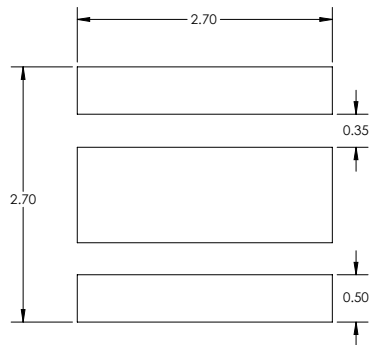
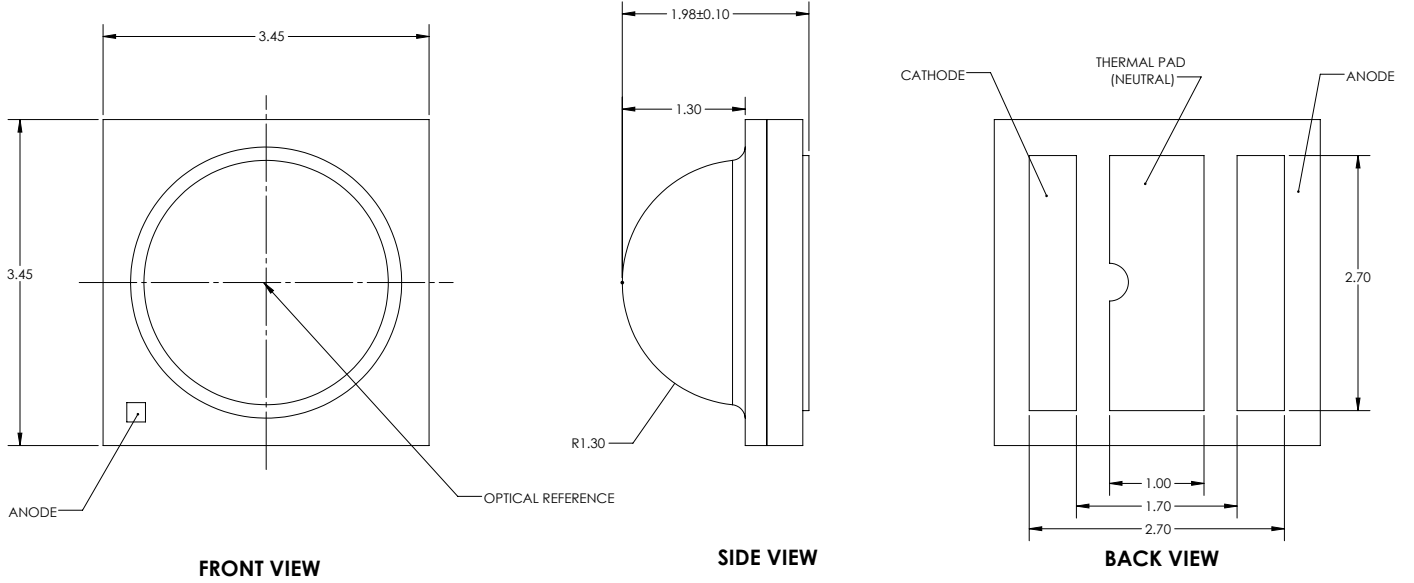

Recommended PCB Solder Pad

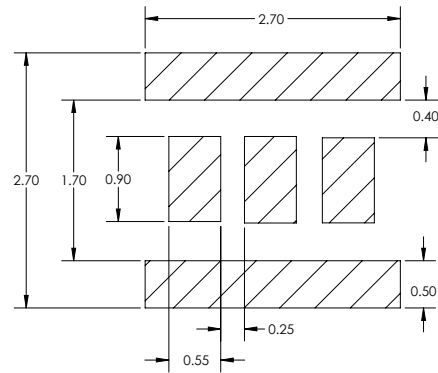

Recommended Stencil Pattern



## Tape and Reel Outline

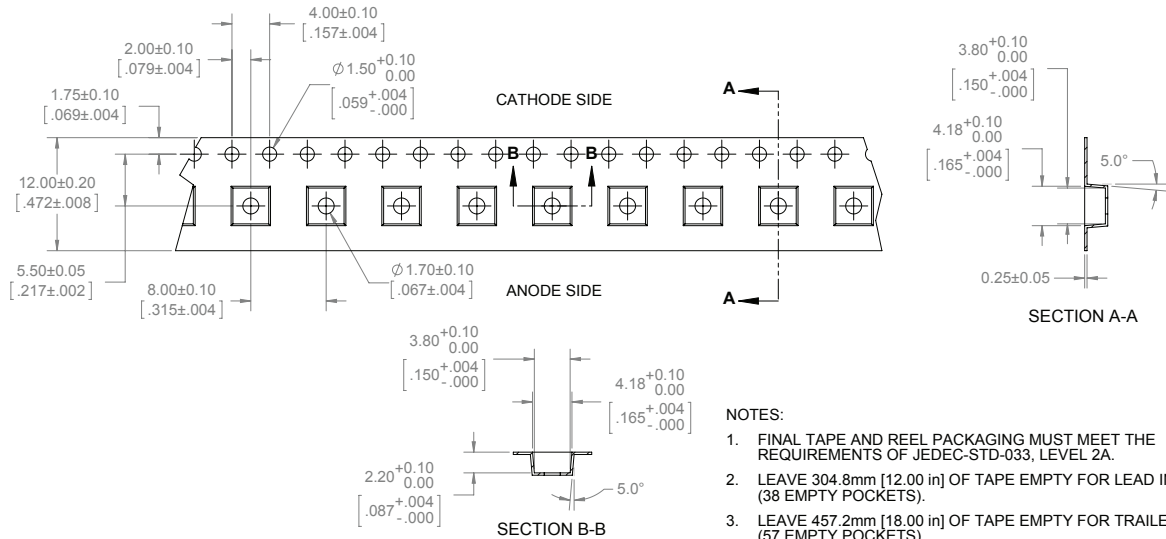

- NOTES:**
1. FINAL TAPE AND REEL PACKAGING MUST MEET THE REQUIREMENTS OF JEDEC-STD-033, LEVEL 2A.
  2. LEAVE 304.8mm [12.00 in] OF TAPE EMPTY FOR LEAD IN (38 EMPTY POCKETS).
  3. LEAVE 457.2mm [18.00 in] OF TAPE EMPTY FOR TRAILER (57 EMPTY POCKETS).
  4. MUST COMPLY TO EIA-481-C-2003

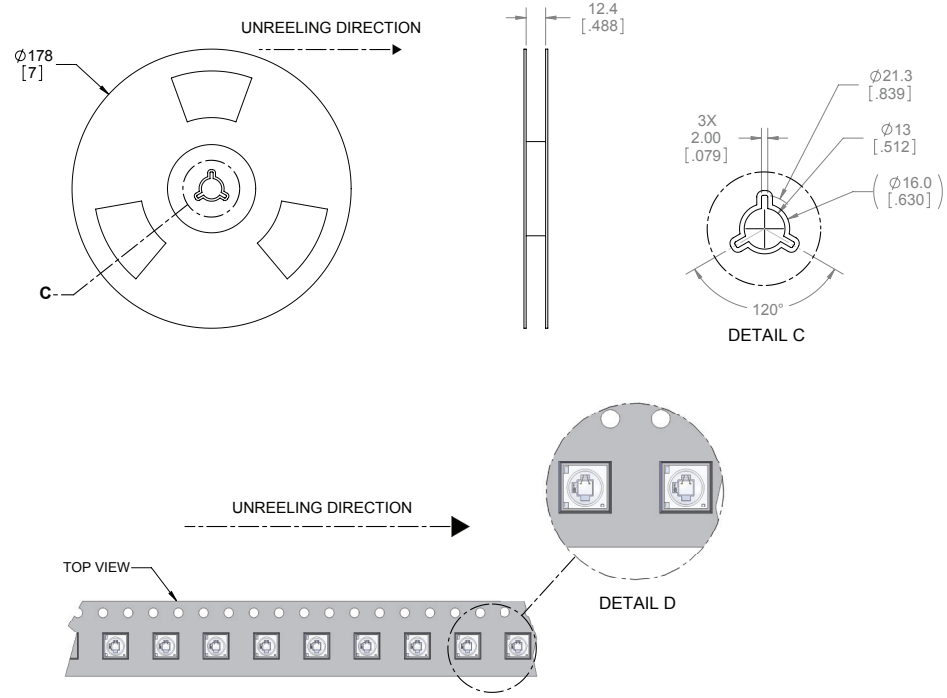



## Shipping Label

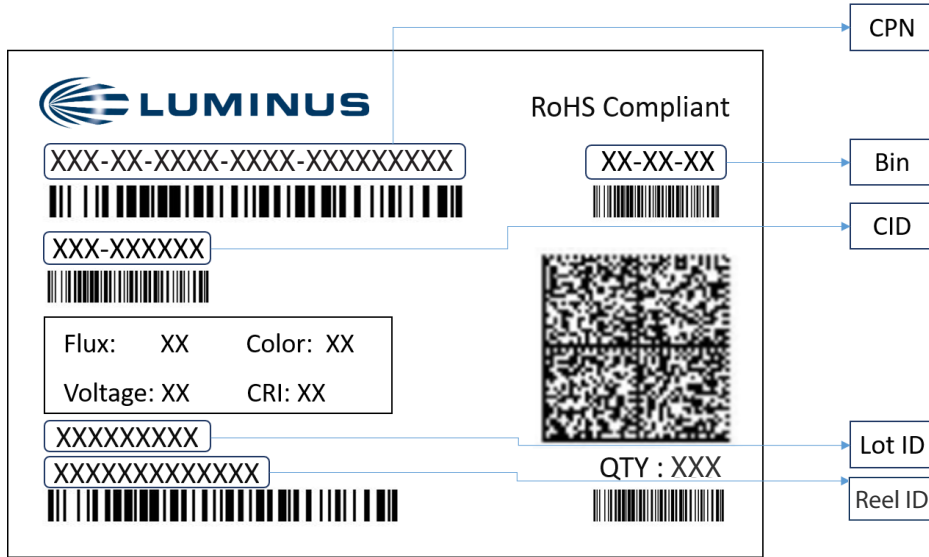

### Label Fields:

- CPN: Luminus ordering part number
- CID: Customer's part number
- QTY: Quantity of devices in pack
- Flux: Bin as defined on page 3
- Voltage: NA
- Color: Bin as defined on page 3
- CRI: NA

### Packing Configuration:

- 500 pieces per pack with 1 reel
- Partial pack or tray may be shipped
- Each pack is enclosed in anti-static bag
- Shipping label is placed on top of each pack



## Notes

### Static Electricity

This product is sensitive to static electricity, and care should be taken when handling them. Static electricity or surge voltage will damage the LEDs. It is recommended to wear an anti-electrostatic wristband or anti-electrostatic gloves when handling the LEDs. All devices, equipment and machinery must be properly grounded. It is recommended that measures be taken to isolate LED processing equipment from potential sources of voltage surges.

Reference: APN-002815 Electrical Stress Damage to LEDs and How to Prevent It

### Eye Safety

SST-10-UV LEDs are short wavelength, UV LEDs. During operation, the LED emits high intensity UVA radiation, which is harmful to skin and eyes. UV light is also hazardous to skin and may cause cancer. Avoid exposure to deep UV light when LED is operational.

Precautions must be taken to avoid looking directly at the UV light without the use of UV light protective glasses. Do not look directly at the front or at the LED's lens when LED is operational.

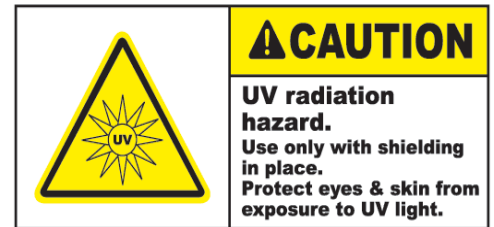
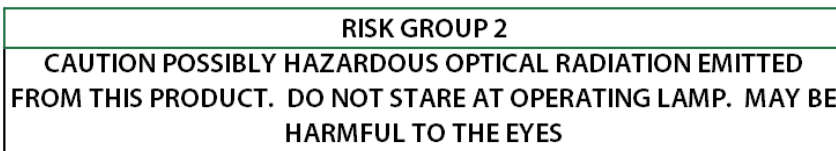

Integration of this LED package into LED sources (arrays, lamps or luminaires) or addition of reflective or magnifying optics may change the expected photobiological safety characteristics of such devices. The assigned risk group classification of the LED package may not necessarily indicate the risk group classification of the LED light source.

### Operating Conditions

In order to ensure the correct functioning of these LEDs, compliance to maximum allowed specifications is important. UV LEDs are particularly sensitive to drive currents that exceed the max operating specifications and may be damaged by such drive currents. The use of current regulated drive circuits is strongly recommended when operating these devices. Customers should also provide adequate thermal management to ensure LEDs do not exceed maximum recommended temperatures. Operating LEDs at temperatures in excess of specification will result in damage and possibly complete failure of the device.

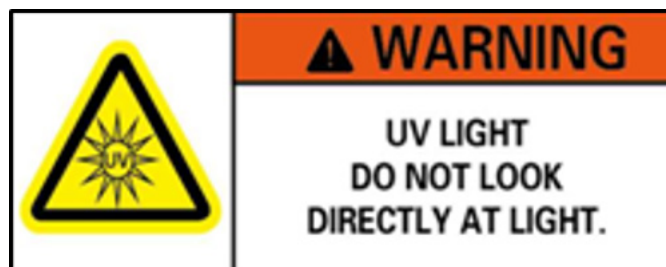



## Revision History

Rev	Date	Description of Change
01	06/01/2018	Initial release.
02	08/31/2018	Added "B130" version: updated ordering part numbers, characterization graphs and mechanical drawings.
03	06/29/2021	Corrected drawings - add Vf bins - fix typos.
04	07/19/2022	Updated ordering bin codes.
05	03/21/2023	Added 415 nm CPNs and LIVT curves. Updated template and editorial correction.

## Looking for pricing, stock, or lifecycle information?

Click below to explore more details on WIN SOURCE:

- [View SST-10-UV-A130-G385-00 on WIN SOURCE](#)
- [Luminus Devices Inc. Information](#)

## Optimize Your Supply Chain with WIN SOURCE Solutions

- ✓ Global Sourcing Solution
- ✓ Obsolete Management
- ✓ Cost Control Management
- ✓ Shortage Management
- ✓ Alternative Solution
- ✓ Excess Inventory Management