



**THE DATASHEET OF  
EAPL4508RGBA0**



### SMD ■ Full Color Side View LEDs (Height 0.8mm) EAPL4508RGBA0

PRELIMINARY



#### Features

- White package.
- Optical indicator.
- Colorless clear window.
- Ideal for backlight and light pipe application.
- Inter reflector.
- Wide viewing angle.
- Suitable for vapor-phase reflow, Infrared reflow and wave solder processes.
- Computable with automatic placement equipment.
- Available on tape and reel (12mm Tape)
- Pb-free
- The product itself will remain within RoHS compliant version.

#### Description

This series is available in soft red, green and blue. Due to the package design, the LED has wide viewing angle and optimized light coupling by inter reflector. This feature makes the ideal for light pipe application. The low current requirement makes this device ideal for portable equipment or any other application where power is at a premium.

#### Applications

- Telecommunication: indicator and backlighting in telephone and fax.
- Flat backlight for LCD's, switches and symbols.
- Light pipe application.
- General use.

## Device Selection Guide

Chip Materials	Emitted Color	Resin Color
AlGaInP	Brilliant Red	Water Clear
InGaN	Brilliant Green	Water Clear
InGaN	Blue	Water Clear

## Absolute Maximum Ratings (Ta=25°C)

Parameter	Symbol	Rating	Unit
Reverse Voltage	$V_R$	5	V
Forward Current	$I_F$	RS	50
		GH/B7	30
Peak Forward Current (Duty 1/10 @1KHz)	$I_{FP}$	100	mA
Power Dissipation	$P_d$	RS	130
		GH/B7	110
Junction Temperature	$T_j$	115	°C
Operating Temperature	$T_{opr}$	-40 ~ +85	°C
Storage Temperature	$T_{stg}$	-40 ~ +90	°C
Thermal Resistance	$R_{th\ J-A}$	500	K/W
	$R_{th\ J-S}$	300	K/W
ESD (Classification acc. AEC Q101)	$ESD_{HBM}$	2000	V
	$ESD_{MM}$	200	V
Soldering Temperature	$T_{sol}$	Reflow Soldering : 260 °C for 10 sec. Hand Soldering : 350 °C for 3 sec.	

### Electro-Optical Characteristics (Ta=25°C)

Parameter	Symbol	Min.	Typ.	Max.	Unit	Condition	
Luminous Intensity	I <sub>v</sub>	RS	200	-----	800	mcd	I <sub>F</sub> =20mA
		GH	500	-----	1300		
		B7	100	-----	550		
Viewing Angle	2θ <sub>1/2</sub>	-----	120	-----	deg	I <sub>F</sub> =20mA	
Peak Wavelength	λ <sub>p</sub>	RS	-----	632	-----	nm	I <sub>F</sub> =20mA
		GH	-----	518	-----		
		B7	-----	468	-----		
Dominant Wavelength	λ <sub>d</sub>	RS	619	-----	629	nm	I <sub>F</sub> =20mA
		GH	525	-----	535		
		B7	455	-----	465		
Spectrum Radiation Bandwidth	Δλ	RS	-----	20	-----	nm	I <sub>F</sub> =20mA
		GH	-----	36	-----		
		B7	-----	26	-----		
Forward Voltage	V <sub>F</sub>	RS	1.7	-----	2.6	V	I <sub>F</sub> =20mA
		GH	2.7	-----	3.7		
		B7	2.7	-----	3.7		
Reverse Current	I <sub>R</sub>	RS	-----	-----	50	μA	V <sub>R</sub> =5V
		GH	-----	-----	50	μA	V <sub>R</sub> =5V
		B7	-----	-----	50	μA	V <sub>R</sub> =5V

Note:

1. Tolerance of Luminous Intensity: ±11%
2. Tolerance of Dominant Wavelength: ±1nm
3. Tolerance of Forward Voltage: ±0.1V

### Typical Electro-Optical Characteristics Curves

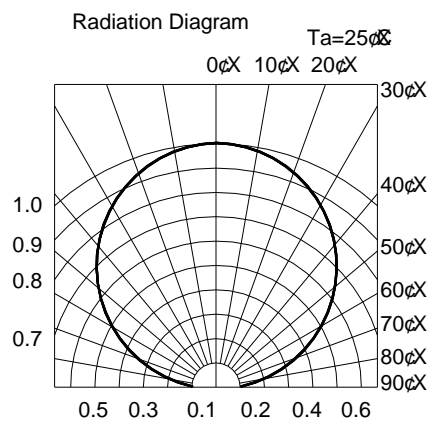
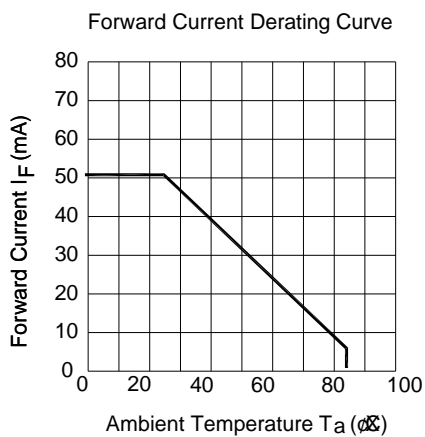
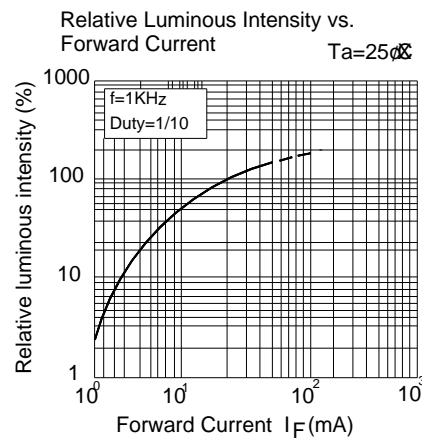
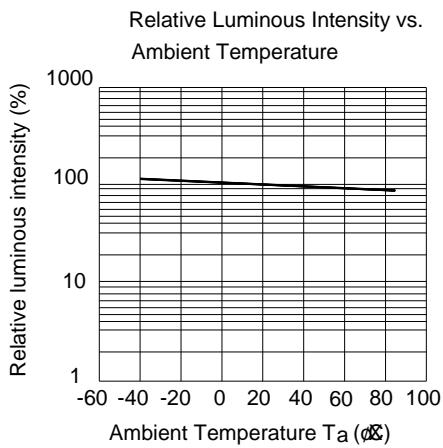
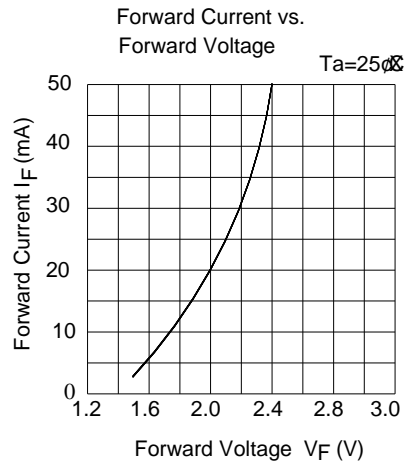
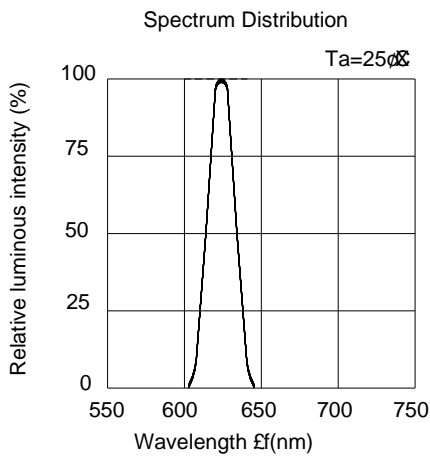

### Typical Electro-Optical Characteristics Curves

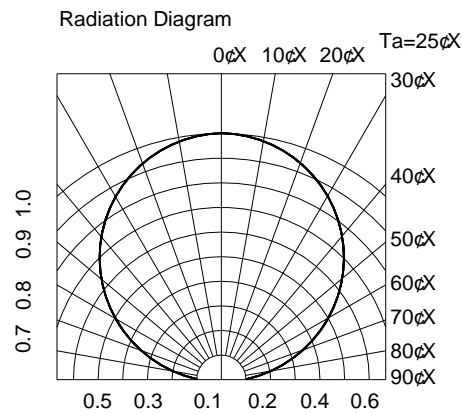
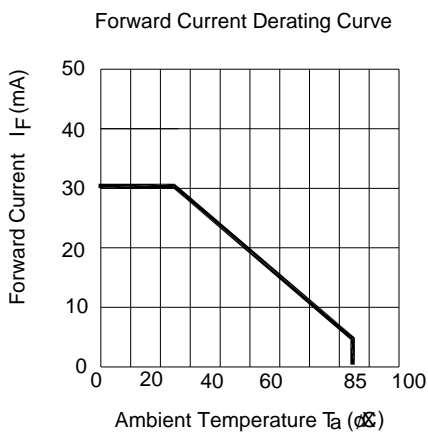
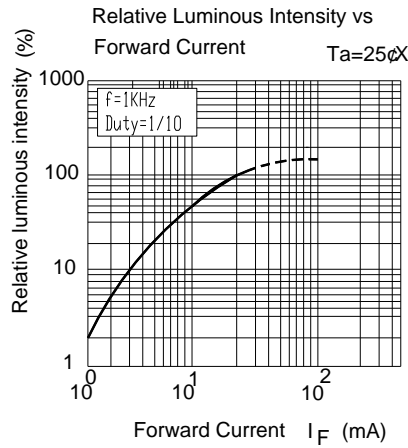
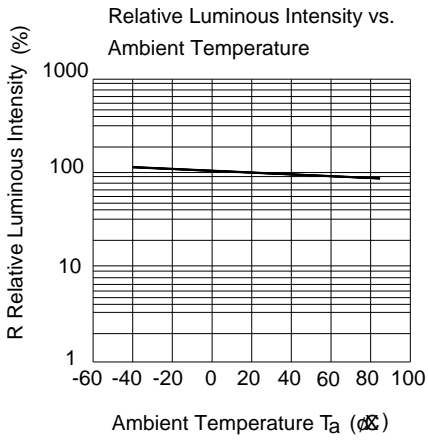
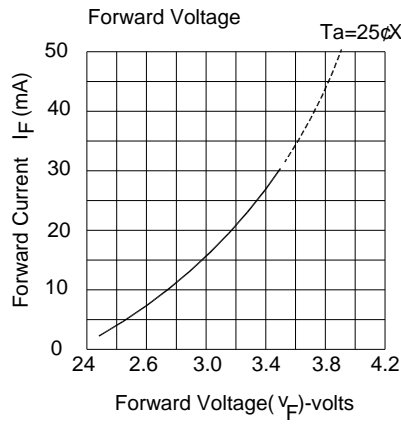
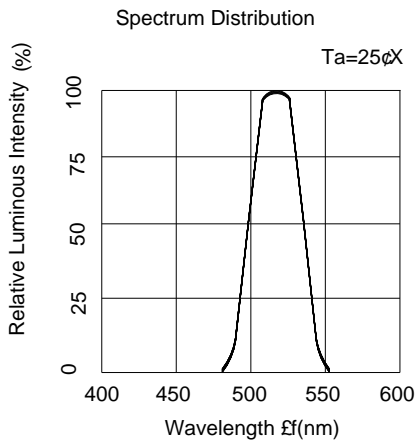

### Typical Electro-Optical Characteristics Curves

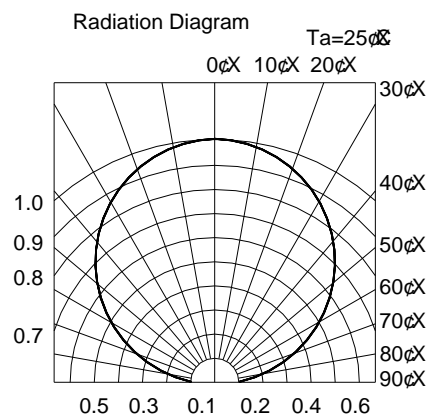
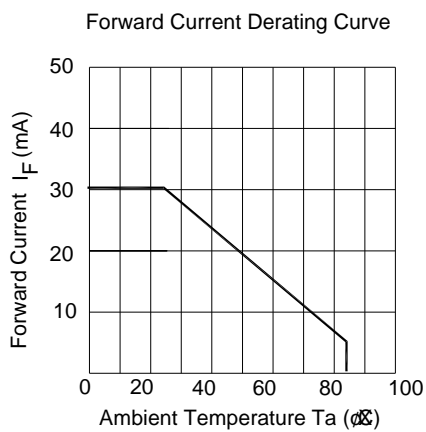
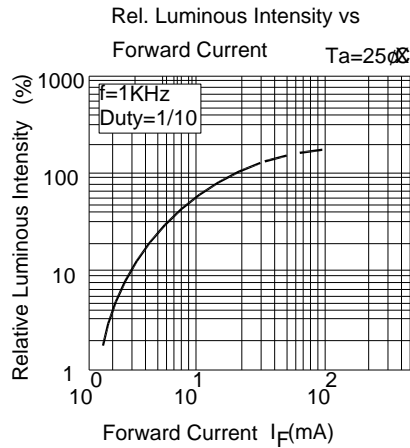
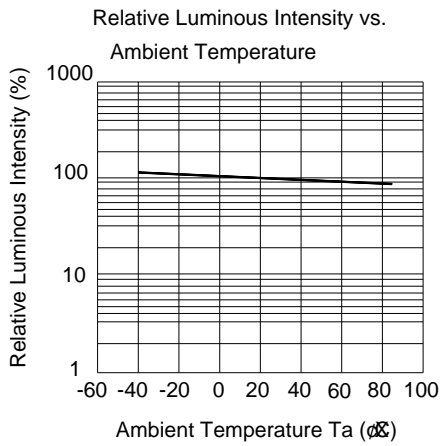
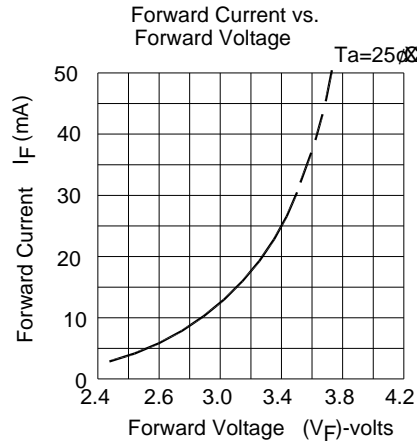
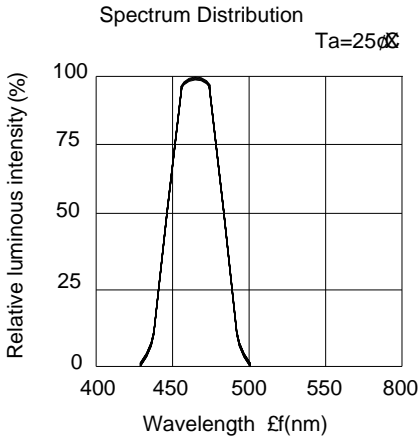

**Package Dimension**

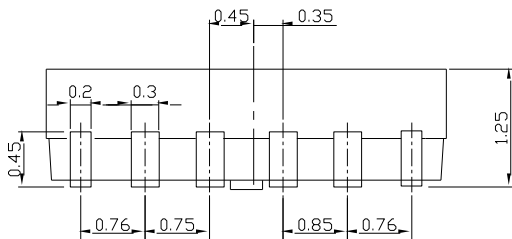
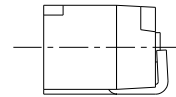
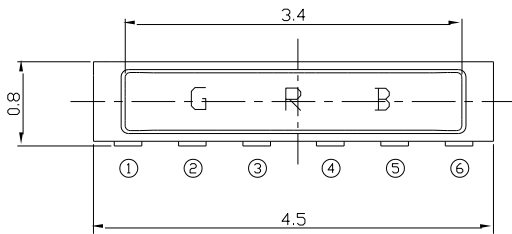
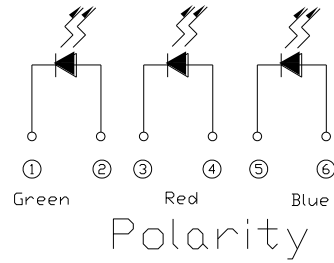
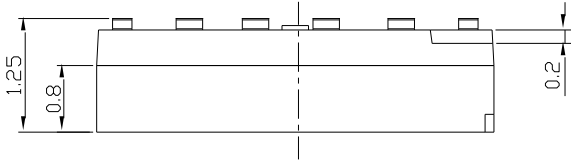

Recommended soldering pad design

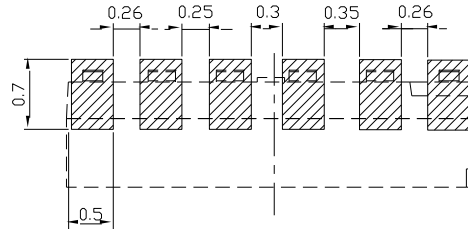

Note: Tolerances unless mentioned  $\pm 0.1\text{mm}$ . Unit = mm

## Moisture Resistant Packing Materials

### Label Explanation



- CPN: Customer's Product Number
- P/N: Product Number
- QTY: Packing Quantity
- CAT: Luminous Intensity Rank
- HUE: Dom. Wavelength Rank
- REF: Forward Voltage Rank
- LOT No: Lot Number

### Reel Dimensions

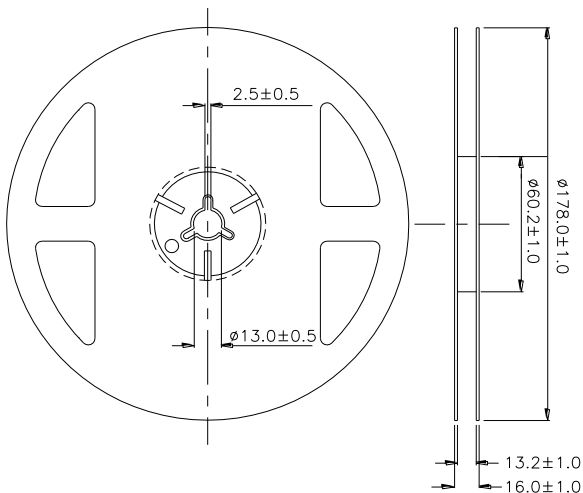

### Carrier Tape Dimensions: Loaded Quantity 2000 pcs Per Reel

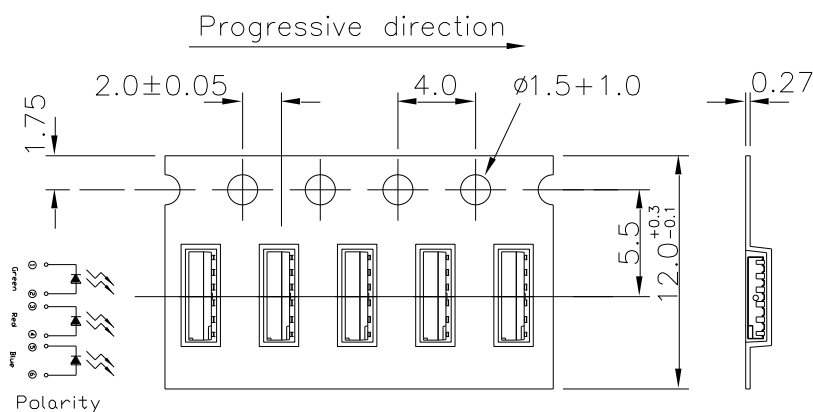

Note: Tolerances unless mentioned  $\pm 0.1$ mm. Unit = mm

### Moisture Resistant Packing Process

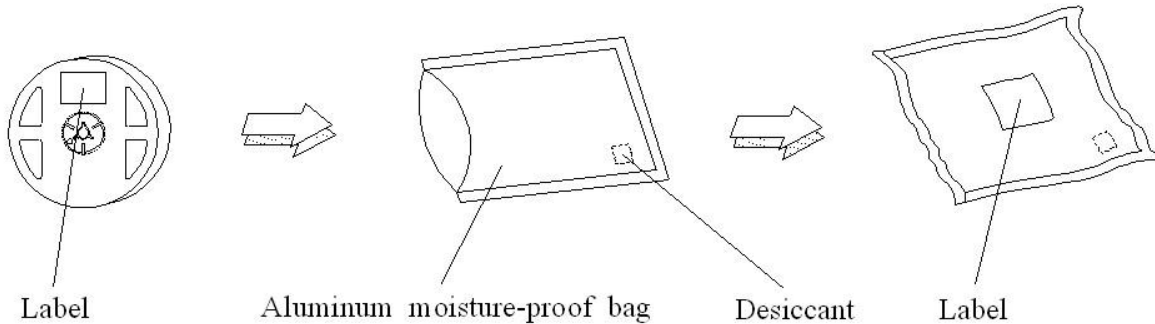

Note: Tolerances unless mentioned  $\pm 0.1\text{mm}$ . Unit = mm

### Precautions for Use

#### 1. Over-current-proof

1.1 Customer must apply resistors for protection, otherwise slight voltage shift will cause big current change ( Burn out will happen ).

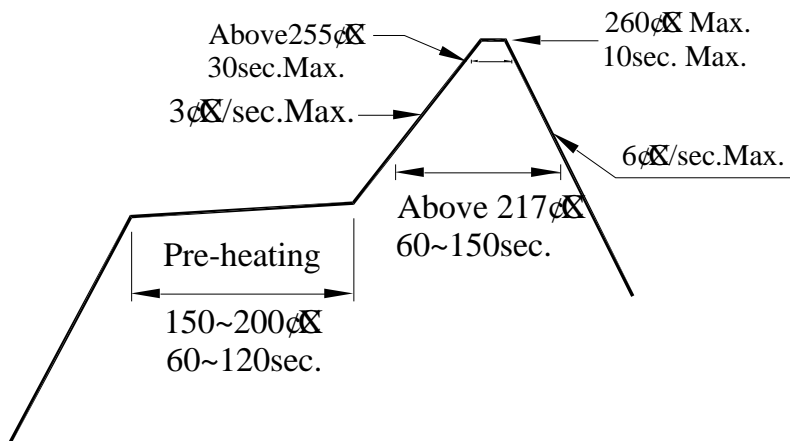

#### 2. Storage

- 2.1 Moisture proof bag should only be opened immediately prior to usage.
- 2.2 Environment should be less than 30°C and 60% RH when moisture proof bag is opened.
- 2.3 After opening the package MSL Conditions stated on page 1 of this spec should not be exceeded.
- 2.4 If the moisture sensitivity card indicates higher than acceptable moisture, the component should be baked at min. 60deg +/-5deg for 24 hours.

#### 3. Soldering Condition

- 3.1 Pb-free solder temperature profile
- 3.2 Reflow soldering should not be done more than two times.
- 3.3 When soldering, do not put stress on the LEDs during heating.
- 3.4 After soldering, do not warp the circuit board.

#### 4. Soldering Iron

Each terminal is to go to the tip of soldering iron temperature less than 350°C for 3 seconds within once in less

than the soldering iron capacity 25W. Leave two seconds and more intervals, and do soldering of each terminal. Be careful because the damage of the product is often started at the time of the hand solder.

#### 5. Repairing

Repair should not be done after the LEDs have been soldered. When repairing is unavoidable, a double-head soldering iron should be used (as below figure). It should be confirmed beforehand whether the characteristics of the LEDs will or will not be damaged by repairing.

### Application Restrictions

High reliability applications such as military/aerospace, automotive safety/security systems, and medical equipment may require different product. If you have any concerns, please contact Everlight before using this product in your application. This specification guarantees the quality and performance of the product as an individual component. Do not use this product beyond the specification described in this document.

### Revision History

Rev.	Modified date	File modified contents
1	2014/05/08	New Spec

## Looking for pricing, stock, or lifecycle information?

Click below to explore more details on WIN SOURCE:

- ⊖ [View EAPL4508RGB A0 on WIN SOURCE](#)
- ⊖ [Everlight Electronics Co Ltd Information](#)

## Optimize Your Supply Chain with WIN SOURCE Solutions

- ✓ Global Sourcing Solution
- ✓ Obsolete Management
- ✓ Cost Control Management
- ✓ Shortage Management
- ✓ Alternative Solution
- ✓ Excess Inventory Management