



**THE DATASHEET OF
S89R11DAC1-12**



S89R/S90R series

Bistable, Impulse Relay 15 and 20 Amp Industrial Rating Continuous Coil Rating

File E22575

File LR15734

Users should thoroughly review the technical data before selecting a product part number. It is recommended that users also seek out the pertinent approvals files of the agencies/laboratories and review them to ensure the product meets the requirements for a given application.

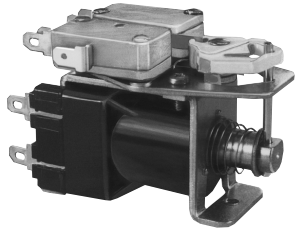

S89R

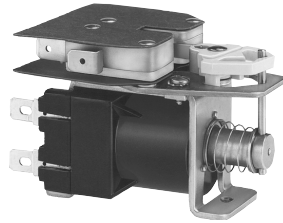

S90R

Features

- Low cost, bistable impulse relay.
- Operates on 75ms min. pulse.
- Used in garage door controls, motor reversing and lighting controls.
- S89R available with plastic cover and octal plug-in base.

Contact Data @ 25°C

Ratings: S89R: 15 amps, 1/2 HP, 125/250VAC; 5 amps, 125VAC, tungsten filament lamp load; 1/2 amp, 125VDC; 1/4 amp, 250VDC.

Expected Life: 100,000 operations, mechanical; 50,000 operations at rated loads.

Ratings: S90R:

Load	Minimum Life
20A, 120VAC or 7.5A, 277VAC, Tungsten.	10,000 Cycles
15A, 125VAC or 7A, 277VAC, Fluorescent.	10,000 Cycles
20A, 277VAC, 75-80% PF.	50,000 Cycles
1 HP, 125VAC, 50/60 Hz.	50,000 Cycles
2 HP, 250VAC, 50/60 Hz.	50,000 Cycles
12 FLA, 60 LRA, 120VAC.	50,000 Cycles
8 FLA, 48 LRA, 240VAC.	50,000 Cycles
Pilot Duty, 360VA, 125/250VAC.	50,000 Cycles

Coil Data @ 25°C

Nominal Power:

DC Coils: 6.33 Watts @ +25°C.

AC Coils: 9VA @ +25°C.

Insulation: Class B (130°C).

Initial Breakdown Voltage: 1,500V rms, 60 Hz.

Must-Operate Voltage:

DC Coils: 75% of nominal voltage @ +25°C.

AC Coils: 85% of nominal voltage @ +25°C.

Coil Data

Nominal Voltage	Resistance DC Ohms ±15% @ +25°C	Nominal Current mA
24VAC	8.7	375
120VAC	260	75
240VAC	1084	38
6VDC	5.8	1035
12VDC	22.5	533
24VDC	92	260

Environmental Data

Temperature Range: -10°C to +60°C.

Mechanical Data

Weight: 7.75 oz. (241g) approximately.

Ordering Information

Typical Part No. ▶	S89R	5	A	B	D	1	-24
1. Basic Series: S89R = 15A S90R = 20A							
2. Contact Arrangement: 5 = SPDT 11 = DPDT 17 = 4PDT							
3. Coil Input: A = AC D = DC							
4. Coil Terminal Style: A = .187" (4.75mm) Quick connect/solder. B = .250" (6.35mm) Quick connect/solder. P = Dust cover with octal plug-in base. (S89R only.)							
5. Switch Terminal Style: C = .187" (4.75mm) Quick connect.* D = .250" (6.35mm) Quick connect. P = Dust cover with octal plug-in base.* * S89R only.							
6. Switch Terminal Configuration: 1 = Style 1 (See outline drawings.)							
7. Coil Voltage: 24, 120, 240VAC 6, 12, 24VDC							

Our authorized distributors are more likely to maintain the following items in stock for immediate delivery.

S89R5ABD1-24	S89R11AAC1-24	S89R11ABD1-120	S89R11DAC1-24	S90R5ABD1-120
S89R5ABD1-120	S89R11AAC1-120	S89R11APP1-120	S89R11DBD1-12	S90R11ABD1-24
S89R5DBD1-12	S89R11ABD1-24	S89R11DAC1-12	S89R11DBD1-24	S90R11ABD1-120

Outline Dimensions

Open Relays

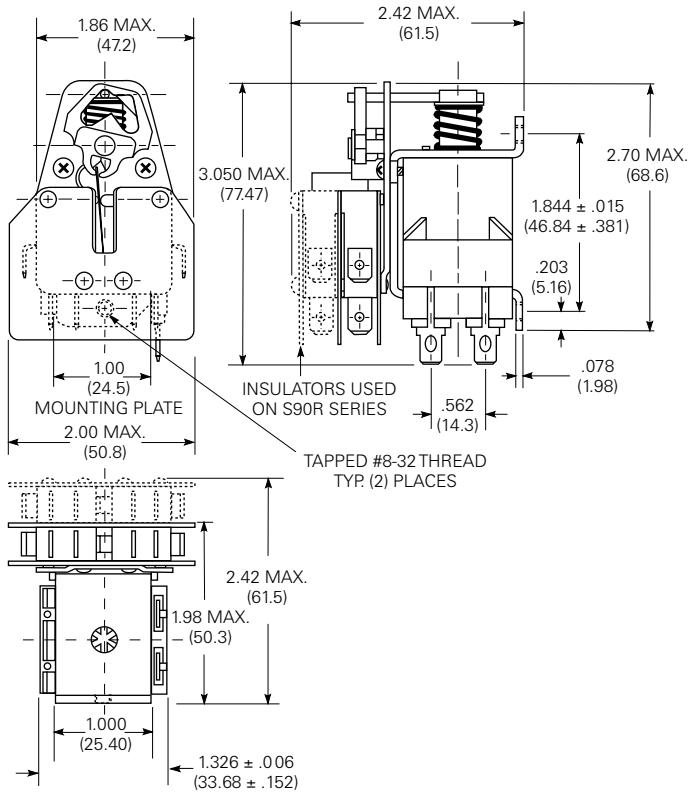

Enclosed Relays
S89 Series

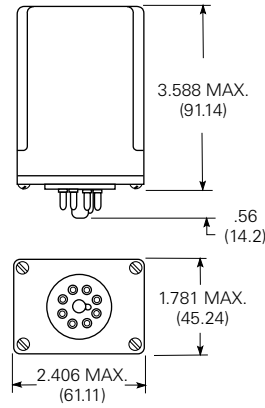

Wiring Diagram

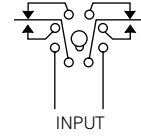

Switch Terminal Configuration

Style 1

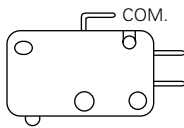

Switch Terminal Style

C = .187" (4.75mm) Quick-connect
D = .250" (6.35mm) Quick-connect

.187" (4.75mm) Quick Connect S89R **.250" (6.35mm) Quick Connect S89R S90R**

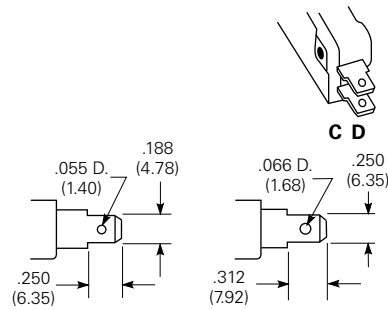

Looking for pricing, stock, or lifecycle information?

Click below to explore more details on WIN SOURCE:

 [View S89R11DAC1-12 on WIN SOURCE](#)

 [TE Connectivity](#) Information

Optimize Your Supply Chain with WIN SOURCE Solutions

-  Global Sourcing Solution
-  Obsolete Management
-  Cost Control Management
-  Shortage Management
-  Alternative Solution
-  Excess Inventory Management