



**THE DATASHEET OF
636L3C024M57600**



Model 636

HCMOS Clock Oscillator

Features

- Ceramic Surface Mount Package
- Operating Temperature Range to -40°C to +105°C
- Fundamental and 3rd Overtone Crystal Designs
- Frequency Range 1.0 – 160MHz
- +1.8V, +2.5V, +3.3V and +5.0V Operation
- Output Enable Standard
- Tape and Reel Packaging, EIA-481

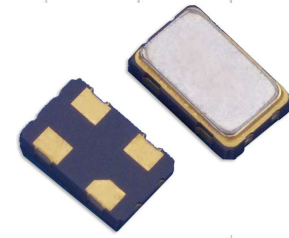

Part Dimensions:
5.0 × 3.2 × 1.3mm • 55.317mg

Standard Frequencies

* See Page 6 for common frequencies.
Check with factory for availability of frequencies not listed.

Applications

- Internet of Things [IoT, IIoT]
- Microcontrollers and FPGAs
- Wireless Communication
- Networking Equipment
- Data Communications
- Computers and Peripherals
- Ethernet/GbE/SyncE
- Portable Devices
- Test and Measurement

Description

CTS Model 636 is a low cost, ultra-low voltage clock oscillator supporting HCMOS output. Employing the latest IC technology, M636 has excellent stability and low phase jitter performance.

Ordering Information

Model	Supply Voltage	Frequency Stability	Temperature Range	Frequency Code [MHz]																																							
636	L	3	I	XXXMXXXXX																																							
	<table border="1"> <thead> <tr> <th>Code</th> <th>Voltage</th> </tr> </thead> <tbody> <tr> <td>M</td> <td>+1.8Vdc</td> </tr> <tr> <td>N</td> <td>+2.5Vdc</td> </tr> <tr> <td>L</td> <td>+3.3Vdc</td> </tr> <tr> <td>S</td> <td>+5.0Vdc</td> </tr> </tbody> </table>	Code	Voltage	M	+1.8Vdc	N	+2.5Vdc	L	+3.3Vdc	S	+5.0Vdc		<table border="1"> <thead> <tr> <th>Code</th> <th>Temp. Range</th> <th>Code</th> <th>Temp. Range</th> </tr> </thead> <tbody> <tr> <td>C</td> <td>-20°C to +70°C</td> <td>I</td> <td>-40°C to +85°C</td> </tr> <tr> <td>D</td> <td>-30°C to +85°C</td> <td>G</td> <td>-40°C to +105°C²</td> </tr> </tbody> </table>	Code	Temp. Range	Code	Temp. Range	C	-20°C to +70°C	I	-40°C to +85°C	D	-30°C to +85°C	G	-40°C to +105°C ²	<table border="1"> <thead> <tr> <th>Code</th> <th>Stability</th> <th>Code</th> <th>Stability</th> </tr> </thead> <tbody> <tr> <td>6</td> <td>±20ppm¹</td> <td>4</td> <td>±30ppm</td> </tr> <tr> <td>5</td> <td>±25ppm</td> <td>3</td> <td>±50ppm</td> </tr> </tbody> </table>	Code	Stability	Code	Stability	6	±20ppm ¹	4	±30ppm	5	±25ppm	3	±50ppm	<table border="1"> <thead> <tr> <th>Code</th> <th>Frequency</th> </tr> </thead> <tbody> <tr> <td colspan="2">Product Frequency Code³</td> </tr> </tbody> </table>	Code	Frequency	Product Frequency Code ³	
Code	Voltage																																										
M	+1.8Vdc																																										
N	+2.5Vdc																																										
L	+3.3Vdc																																										
S	+5.0Vdc																																										
Code	Temp. Range	Code	Temp. Range																																								
C	-20°C to +70°C	I	-40°C to +85°C																																								
D	-30°C to +85°C	G	-40°C to +105°C ²																																								
Code	Stability	Code	Stability																																								
6	±20ppm ¹	4	±30ppm																																								
5	±25ppm	3	±50ppm																																								
Code	Frequency																																										
Product Frequency Code ³																																											

Notes:

- 1] Consult factory for availability of 6I Stability/Temperature combination.
- 2] Available with stability codes 4 and 3.
- 3] Frequency is recorded with 3 leading digits before and 5 significant digits after the "M" [including zeroes].
[Ex. 3.579545MHz = 003M57954; 14.31818MHz = 014M31818; 25MHz = 025M00000; 125MHz = 125M00000]

**Not all performance combinations and frequencies may be available.
Contact your local CTS Representative or CTS Customer Service for availability.**

This product is specified for use only in standard commercial applications. Supplier disclaims all express and implied warranties and liability in connection with any use of this product in any non-commercial applications or in any application that may expose the product to conditions that are outside of the tolerances provided in its specification.



Electrical Specifications

Operating Conditions

PARAMETER	SYMBOL	CONDITIONS	MIN	TYP	MAX	UNIT
Maximum Supply Voltage	V _{CC}	-	-0.5	-	7.0	V
Supply Voltage	V _{CC}	±10%	1.62	1.8	1.98	V
			2.25	2.5	2.75	
			2.97	3.3	3.63	
			4.50	5.0	5.50	
Supply Current	I _{CC}	Typical @ Nominal V _{CC} , C _L = 15 pF, T _A = +25°C				
		@ +1.8V, 1.0MHz to <60MHz	-	2	4	
		@ +1.8V, 60MHz to <100MHz	-	5	15	mA
		@ +1.8V, 100MHz to 160MHz	-	8	25	
		@ +2.5V, 1.0MHz to <60MHz	-	3	10	
		@ +2.5V, 60MHz to <100MHz	-	8	20	mA
		@ +2.5V, 100MHz to 160MHz	-	12	30	
		@ +3.3V, 1.0MHz to <60MHz	-	3	15	
		@ +3.3V, 60MHz to <100MHz	-	9	25	mA
		@ +3.3V, 100MHz to 160MHz	-	16	35	
		@ +5.0V, 1.0MHz to <60MHz	-	8	20	
		@ +5.0V, 60MHz to <100MHz	-	12	30	mA
@ +5.0V, 100MHz to 106.25MHz	-	20	40			
Output Load	C _L	-	-	-	15	pF
Operating Temperature	T _A	-	-20		+70	°C
			-30	+25	+85	
			-40		+85	
			-40		+105	
Storage Temperature	T _{STG}	-	-55	-	+125	°C

Frequency Stability

PARAMETER	SYMBOL	CONDITIONS	MIN	TYP	MAX	UNIT
Frequency Range	f _O	-		1.0 - 160		MHz
Frequency Stability [Note 1]	Δf/f _O	-		20, 25, 30, 50		±ppm
Aging	Δf/f ₂₅	First Year @ +25°C, nominal V _{CC}	-3	-	3	ppm

1.] Inclusive of initial tolerance at time of shipment, changes in supply voltage, load, temperature and 1st year aging.

Electrical Specifications

Output Parameters

PARAMETER	SYMBOL	CONDITIONS	MIN	TYP	MAX	UNIT
Output Type	-	-		HCMOS		-
Output Voltage Levels	V_{OH}	Logic '1' Level, CMOS Load	$0.9V_{CC}$	-	-	V
	V_{OL}	Logic '0' Level, CMOS Load	-	-	$0.1V_{CC}$	
Output Current Levels	I_{OH}	$V_{OH} = 90\%V_{CC}$ [+1.8V,+2.5V,+3.3V,+5.0V]	-	-	-4, -4, -8, -16	mA
	I_{OL}	$V_{OL} = 10\%V_{CC}$ [+1.8V,+2.5V,+3.3V,+5.0V]	-	-	+4, +4, +8, +16	
Output Duty Cycle	SYM	@ 50% Level	45	-	55	%
Rise and Fall Time [Note 2]	T_R, T_F	@ 10%/90% Levels, Nominal V_{CC} , $C_L = 15pF$				
		@ +1.8V, 1.0MHz to <20MHz	-	-	3	
		@ +1.8V, 20MHz to <125MHz	-	-	3	ns
		@ +1.8V, 125MHz to 160MHz	-	-	3	
		@ +2.5V or +3.3V, 1.0MHz to <20MHz	-	-	5	
		@ +2.5V or +3.3V, 20MHz to <125MHz	-	-	4	ns
		@ +2.5V or +3.3V, 125MHz to 160MHz	-	-	3	
		@ +5.0V, 1.0MHz to <20MHz	-	-	5	
@ +5.0V, 20MHz to <125MHz	-	-	4	ns		
@ +5.0V, 125MHz to 106.25MHz	-	-	3			
Start Up Time	T_S	Application of V_{CC}	-	2	5	ms
Enable Function		Standby				
Enable Input Voltage	V_{IH}	Pin 1 Logic '1', Output Enabled	$0.7V_{CC}$	-	-	V
Disable Input Voltage	V_{IL}	Pin 1 Logic '0', Output Standby	-	-	$0.3V_{CC}$	V
Standby Current	I_{STB}	Pin 1 Logic '0', Output Standby	-	-	15	μA
Enable Time	T_{PLZ}	Pin 1 Logic '1', Output Enabled	-	-	5	ms
Phase Jitter, RMS [Note 3]	t_{jrms}	Bandwidth 12kHz - 20MHz	-	0.5	<1	ps

2.] Parameters are worst case and account for comprehensive range of product specification. Performance may vary by application and must be validated by end user.

3.] For frequencies 10MHz - 40MHz, the measurement Bandwidth is 12kHz - 5MHz.

Enable Truth Table

Pin 1	Pin 4
Logic '1'	Output Enabled
Open	Output Enabled
Logic '0'	Output Disabled, High Impedance

Test Circuit

HCMOS

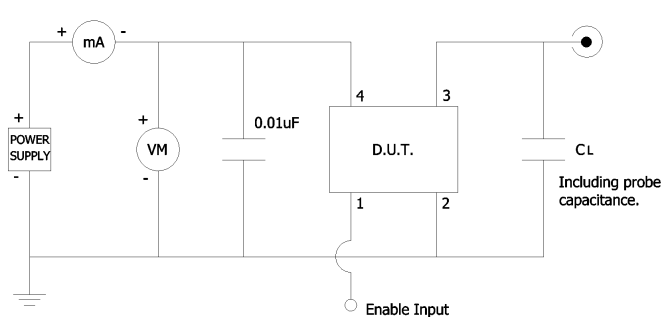

Output Waveform

HCMOS

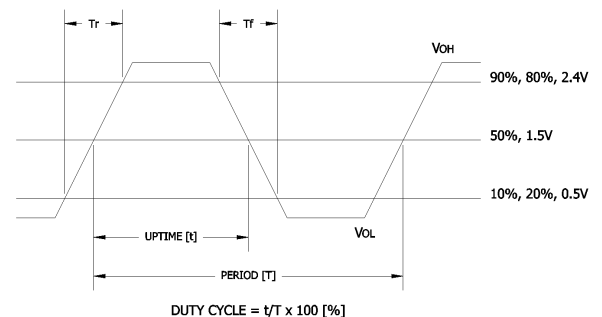

Mechanical Specifications

Package Drawing

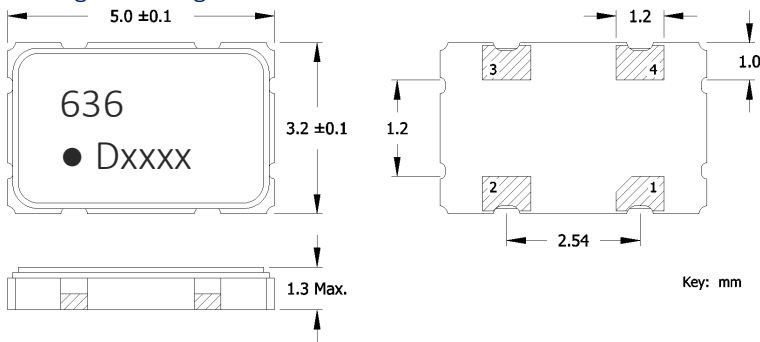

Marking Information

1. 636 – CTS Model.
2. D – Date Code. See Table I for codes.
3. xxxx – Frequency Code.
3-digits, frequencies below 100MHz
4-digits, frequencies 100MHz or greater
[See document 016-1454-0, Frequency Code Tables.]

Recommended Pad Layout

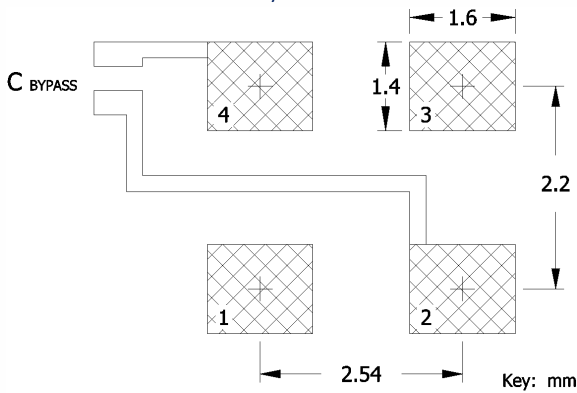

Notes

1. JEDEC termination code (e4). Barrier-plating is nickel [Ni] with gold [Au] flash plate.
2. Reflow conditions per JEDEC J-STD-020; +260°C maximum, 20 seconds.
3. MSL = 1.

Pin Assignments

Pin	Symbol	Function
1	EOH	Enable
2	GND	Circuit & Package Ground
3	Output	RF Output
4	V _{CC}	Supply Voltage

Table I - Date Code, Beginning year 2021

YEAR \ MONTH					JAN	FEB	MAR	APR	MAY	JUN	JUL	AUG	SEP	OCT	NOV	DEC
					2021	2025	2029	2033	2037	A	B	C	D	E	F	G
2022	2026	2030	2034	2038	N	P	Q	R	S	T	U	V	W	X	Y	Z
2023	2027	2031	2035	2039	a	b	c	d	e	f	g	h	j	k	l	m
2024	2028	2032	2036	2040	n	p	q	r	s	t	u	v	w	x	y	z





Addendum

Common Frequencies – MHz

FREQUENCY	FREQUENCY CODE	FREQUENCY	FREQUENCY CODE	FREQUENCY	FREQUENCY CODE	FREQUENCY	FREQUENCY CODE
1.544000	001M54400	12.288000	012M28800	25.000000	025M00000	37.400000	037M40000
3.072000	003M07200	13.000000	013M00000	26.000000	026M00000	38.400000	038M40000
3.200000	003M20000	14.318180	014M31818	27.000000	027M00000	40.000000	040M00000
3.686400	003M68640	14.745600	014M74560	27.120000	027M12000	48.000000	048M00000
4.000000	004M00000	15.625000	015M62500	28.636360	028M63636	50.000000	050M00000
6.000000	006M00000	16.000000	016M00000	29.491200	029M49120	54.000000	054M00000
7.372800	007M37280	19.200000	019M20000	30.000000	030M00000	80.000000	080M00000
8.000000	008M00000	20.000000	020M00000	30.720000	030M72000	100.000000	100M00000
10.000000	010M00000	24.000000	024M00000	32.000000	032M00000	125.000000	125M00000
12.000000	012M00000	24.576000	024M57600	33.000000	033M00000	160.000000	160M00000

Looking for pricing, stock, or lifecycle information?

Click below to explore more details on WIN SOURCE:

-  [View 636L3C024M57600 on WIN SOURCE](#)
-  [CTS-Frequency Controls Information](#)

Optimize Your Supply Chain with WIN SOURCE Solutions

-  Global Sourcing Solution
-  Obsolete Management
-  Cost Control Management
-  Shortage Management
-  Alternative Solution
-  Excess Inventory Management