



**THE DATASHEET OF
HH18N102F500CT**



APPROVAL SHEET

MULTILAYER CERAMIC CAPACITORS

High Q / Low ESR Series (HH)

0201 to 0805 Sizes

NP0 Dielectric

Halogen Free & RoHS Compliance



*Contents in this sheet are subject to change without prior notice.

Multilayer Ceramic Capacitors

1. INTRODUCTION

MLCC consists of a conducting material and electrodes. To manufacture a chip-type SMT and achieve miniaturization, high density and high efficiency, ceramic condensers are used.

WTC HH series MLCC is used at high frequencies generally have a small temperature coefficient of capacitance, typical within the $\pm 30\text{ppm}/^\circ\text{C}$ required for NP0 (COG) classification and have excellent conductivity internal electrode. Thus, WTC HH series MLCC will be with the feature of low ESR and high Q characteristics.

2. FEATURES

- a. High Q and low ESR performance at high frequency.
- b. Quality improvement of telephone calls for low power loss and better performance.

3. APPLICATIONS

- a. Mobile telecommunication: Mobile phone, WLAN.
- b. RF module: Power amplifier, VCO.
- c. Tuners.

4. HOW TO ORDER

<u>HH</u>	<u>15</u>	<u>N</u>	<u>100</u>	<u>G</u>	<u>500</u>	<u>C</u>	<u>I</u>
<u>Series</u>	<u>Size</u>	<u>Dielectric</u>	<u>Capacitance</u>	<u>Tolerance</u>	<u>Rated voltage</u>	<u>Termination</u>	<u>Packaging</u>
HH=High Q/ Low ESR	03=0201 (0603) 15=0402 (1005) 18=0603 (1608) 21=0805 (2012)	N=NP0 (COG)	Two significant digits followed by no. of zeros. And R is in place of decimal point. eg.: R47=0.47pF 0R5=0.5pF 1R0=1.0pF 100=10x10 ⁰ =10pF	A=±0.05pF B=±0.1pF C=±0.25pF D=±0.5pF F=±1% G=±2% J=±5%	Two significant digits followed by no. of zeros. And R is in place of decimal point. 100=10 VDC 160=16 VDC 250=25 VDC 500=50 VDC 101=100 VDC 201=200 VDC 251=250 VDC 501=500 VDC 631=630 VDC	C=Cu/Ni/Sn	T=7" reeled G=13" reeled

Multilayer Ceramic Capacitors

5. EXTERNAL DIMENSIONS

Size Inch (mm)	L (mm)	W (mm)	T (mm)/Symbol	Remark	M _B (mm)
0201 (0603)	0.6±0.03	0.3±0.03	0.3±0.03	L #	0.15±0.05
0402 (1005)	1.00±0.05	0.50±0.05	0.50±0.05	N #	0.25 +0.05/-0.10
0603 (1608)	1.60±0.10	0.80±0.10	0.80±0.07	S	0.40±0.15
	1.60 +0.15/-0.10	0.80 +0.15/-0.10	0.80 +0.15/-0.10	X	
0805 (2012)	2.00±0.15	1.25±0.10	0.60±0.10	A	0.50±0.20
			0.80±0.10	B	
			1.25±0.10	D #	

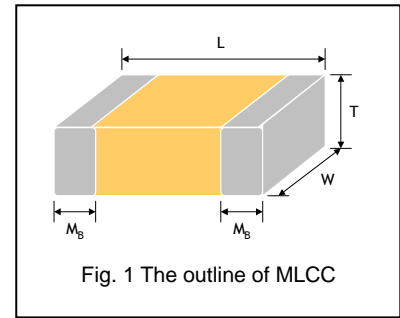

Reflow soldering only is recommended.

6. GENERAL ELECTRICAL DATA

Dielectric	NP0
Size	0201, 0402, 0603, 0805
Capacitance*	0.1pF to 3300pF
Capacitance tolerance	Cap≤5pF ^{#1} : A (±0.05pF), B (±0.1pF), C (±0.25pF) 5pF<Cap<10pF: C (±0.25pF), D (±0.5pF) Cap≥10pF: F (±1%), G (±2%), J (±5%)
Rated voltage (WVDC)	10V, 16V, 25V, 50V, 100V, 200V, 250V, 500V, 630V
Q*	Cap<30pF: Q≥400+20C Cap≥30pF: Q≥1000
Insulation resistance at U _r	≥10GΩ or R _x C≥100Ω·F whichever is smaller.
Operating temperature	-55 to +125°C
Capacitance change	±30ppm
Termination	Ni/Sn (lead-free termination)

#1: NP0, 0.1pF product only provide B tolerance

* Measured at the conditions of 25°C ambient temperature and 30~70% related humidity.

Apply 1.0±0.2V_{rms}, 1.0MHz±10% for Cap≤1000pF and 1.0±0.2V_{rms}, 1.0kHz±10% for Cap>1000pF.

7. PACKAGING DIMENSION AND QUANTITY

Size	Thickness (mm)/Symbol		Paper tape		Plastic tape	
			7" reel	13" reel	7" reel	13" reel
0201	0.30±0.03	L	15,000	70,000	-	-
0402	0.50±0.05	N	10,000	50,000	-	-
0603	0.80±0.07	S	4,000	15,000	-	-
	0.80 +0.15/-0.10	X				
0805	0.60±0.10	A	4,000	15,000	-	-
	0.80±0.10	B				
	1.25±0.10	D	-	-	3,000	10,000

Unit: pieces

Multilayer Ceramic Capacitors

8. CAPACITANCE RANGE

DIELECTRIC		NP0																			
SIZE		0201					0402				0603					0805					
Rated Voltage		10	16	25	50	100	16	25	50	100	16	25	50	100	200	50	100	200	250	500	630
Capacitance	0.1pF (0R1)						N	N	N	N											
	0.2pF (0R2)						N	N	N	N											
	0.3pF (0R3)	L	L	L	L	L	N	N	N	N											
	0.4pF (0R4)	L	L	L	L	L	N	N	N	N											
	0.5pF (0R5)	L	L	L	L	L	N	N	N	N	S	S	S	S	S	B	B				
	0.6pF (0R6)	L	L	L	L	L	N	N	N	N	S	S	S	S	S	B	B				
	0.7pF (0R7)	L	L	L	L	L	N	N	N	N	S	S	S	S	S	B	B				
	0.8pF (0R8)	L	L	L	L	L	N	N	N	N	S	S	S	S	S	B	B				
	0.9pF (0R9)	L	L	L	L	L	N	N	N	N	S	S	S	S	S	B	B				
	1.0pF (1R0)	L	L	L	L	L	N	N	N	N	S	S	S	S	S	B	B	B	B	B	B
	1.2pF (1R2)	L	L	L	L	L	N	N	N	N	S	S	S	S	S	B	B	B	B	B	B
	1.5pF (1R5)	L	L	L	L	L	N	N	N	N	S	S	S	S	S	B	B	B	B	B	B
	1.6pF (1R6)					L															
	1.8pF (1R8)	L	L	L	L	L	N	N	N	N	S	S	S	S	S	B	B	B	B	B	B
	2.2pF (2R2)	L	L	L	L	L	N	N	N	N	S	S	S	S	S	B	B	B	B	B	B
	2.7pF (2R7)	L	L	L	L	L	N	N	N	N	S	S	S	S	S	B	B	B	B	B	B
	3.0pF (3R0)					L															
	3.3pF (3R3)	L	L	L	L	L	N	N	N	N	S	S	S	S	S	B	B	B	B	B	B
	3.9pF (3R9)	L	L	L	L	L	N	N	N	N	S	S	S	S	S	B	B	B	B	B	B
	4.7pF (4R7)	L	L	L	L	L	N	N	N	N	S	S	S	S	S	B	B	B	B	B	B
	5.6pF (5R6)	L	L	L	L	L	N	N	N	N	S	S	S	S	S	B	B	B	B	B	B
	6.8pF (6R8)	L	L	L	L	L	N	N	N	N	S	S	S	S	S	B	B	B	B	B	B
	8.2pF (8R2)	L	L	L	L	L	N	N	N	N	S	S	S	S	S	B	B	B	B	B	B
	10pF (100)	L	L	L	L	L	N	N	N	N	S	S	S	S	S	B	B	B	B	B	B
	12pF (120)	L	L	L	L	L	N	N	N	N	S	S	S	S		B	B	B	B	B	B
	15pF (150)	L	L	L	L	L	N	N	N	N	S	S	S	S		B	B	B	B	B	B
	18pF (180)	L	L	L	L	L	N	N	N	N	S	S	S	S		B	B	B	B	B	B
	22pF (220)	L	L	L	L	L	N	N	N	N	S	S	S	S		B	B	B	B	B	B
	27pF (270)	L	L	L	L	L	N	N	N	N	S	S	S	S		B	B	B	B	B	B
	33pF (330)	L	L	L	L	L	N	N	N	N	S	S	S	S		B	B	B	B	B	B
	39pF (390)						N	N	N	N	S	S	S	S		B	B	B	B	B	B
	47pF (470)						N	N	N	N	S	S	S	S		B	B	B	B	B	B
	56pF (560)						N	N	N	N	S	S	S	S		B	B	B	B	B	B
68pF (680)						N	N	N	N	S	S	S	S		B	B	B	B	B	B	
82pF (820)						N	N	N	N	S	S	S	S		B	B	B	B	B	B	
100pF (101)						N	N	N	N	S	S	S	S		B	B	B	B	B	B	
120pF (121)						N	N	N	N	S	S	S	S		D	D	D	D	D	D	
150pF (151)						N	N	N	N	S	S	S	S		D	D	D	D	D	D	
180pF (181)						N	N	N	N	S	S	S	S				D	D	D	D	
220pF (221)						N	N	N	N	S	S	S	S				D	D	D	D	
270pF (271)						N	N	N		S	S	S	S				D	D	D	D	
330pF (331)						N	N	N		S	S	S	S				D	D	D	D	
390pF (391)						N	N	N		S	S	S	S				D	D	D	D	
470pF (471)						N	N	N		S	S	S	S								
560pF (561)										S	S	S	S								
680pF (681)										S	S	S	S								
820pF (821)										S	S	S	S								
1,000pF (102)										S	S	S	S								
1,200pF (122)										X	X	X									
1,500pF (152)										X	X	X									
1,800pF (182)										X	X	X									
2,200pF (222)										X	X	X									
2,700pF (272)										X	X	X									
3,300pF (332)										X	X	X									

- The letter in cell is expressed the symbol of product thickness.
- For more information about products with special capacitance or other data, please contact WTC local representative.

Multilayer Ceramic Capacitors

9. ELECTRICAL CHARACTERISTICS

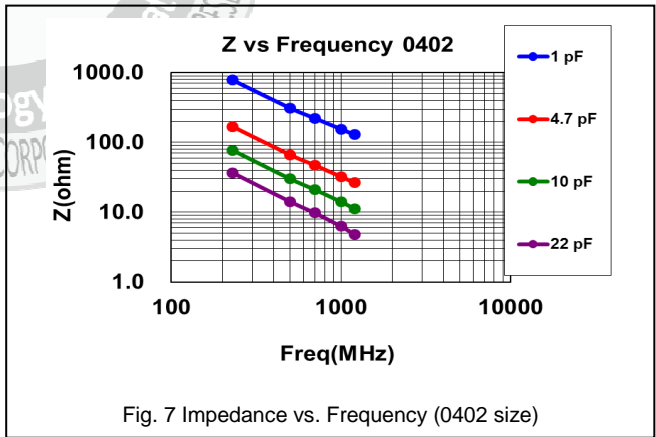
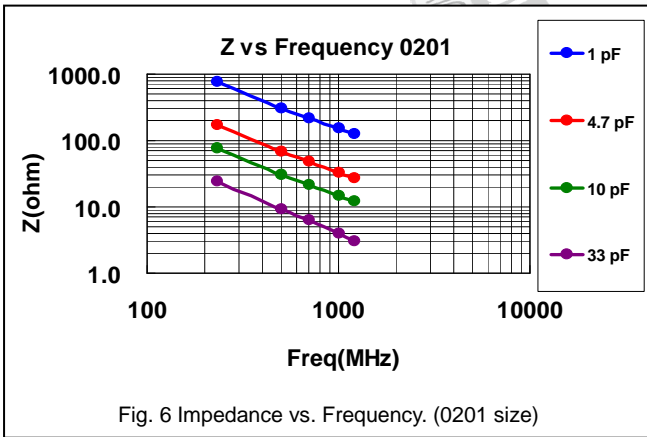
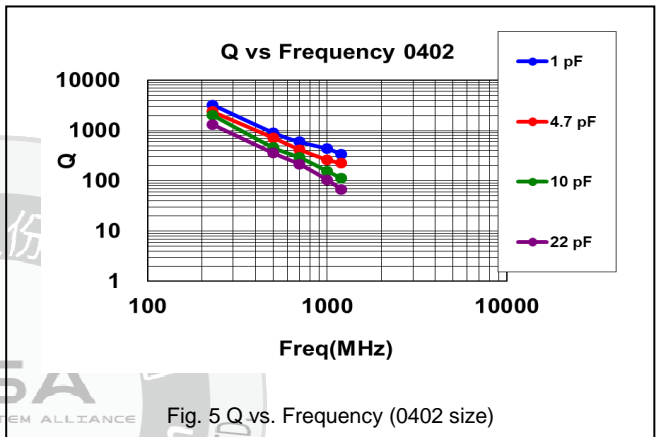
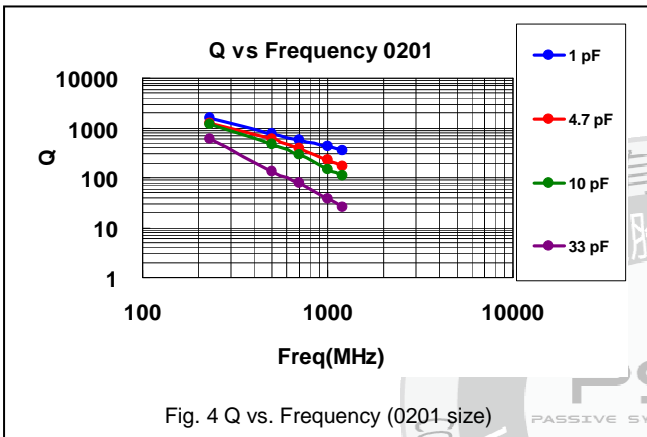
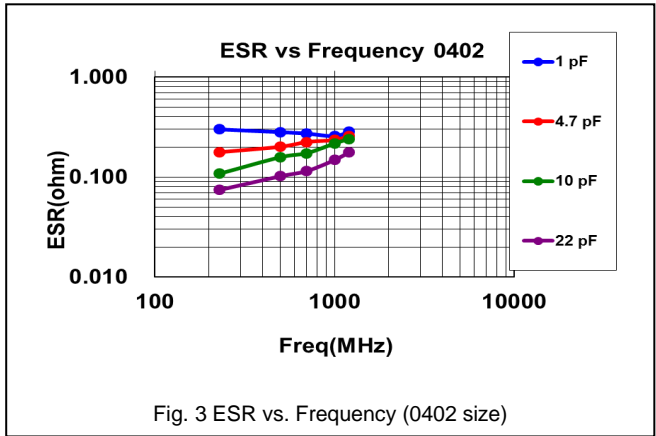
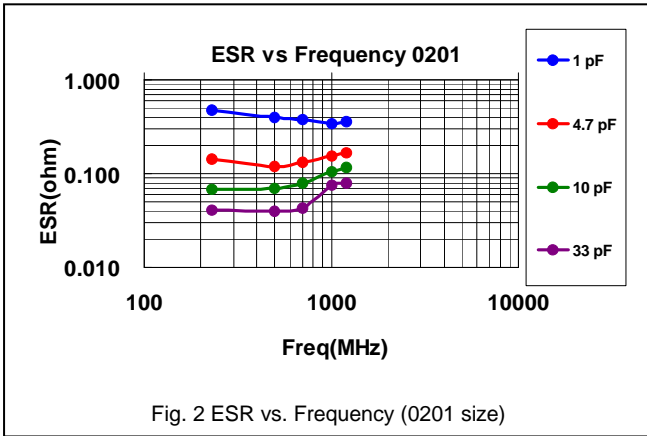

Multilayer Ceramic Capacitors

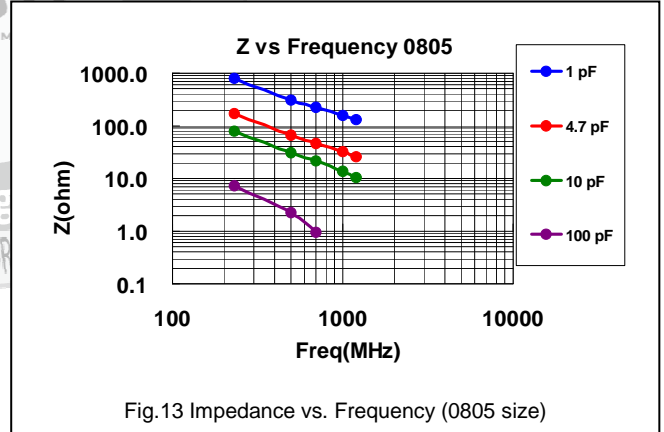
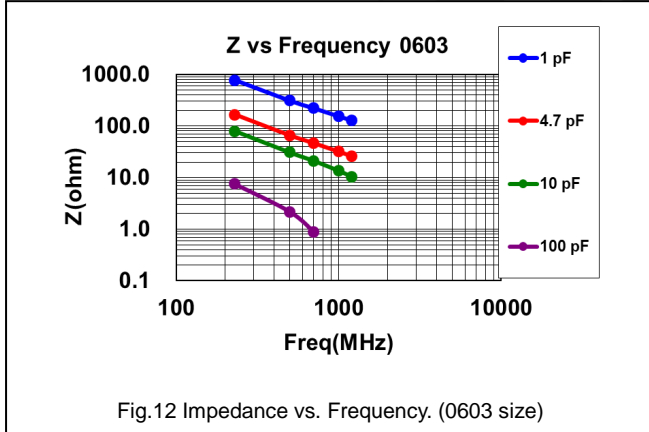
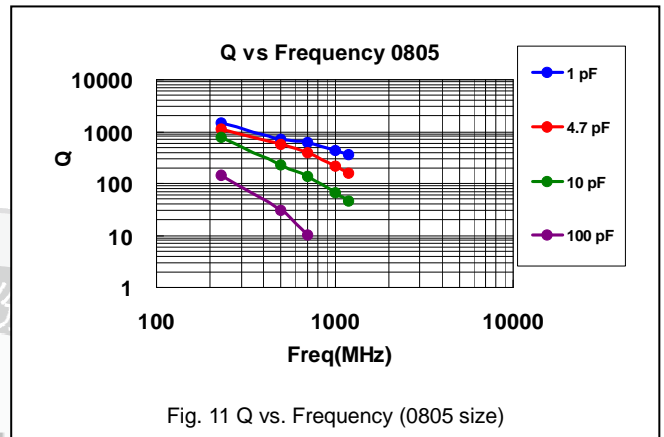
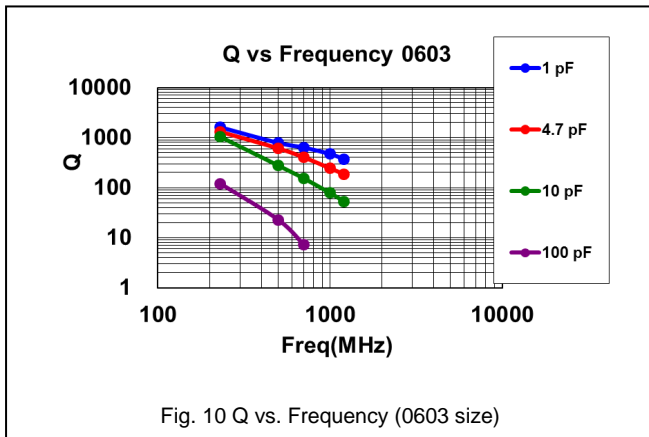
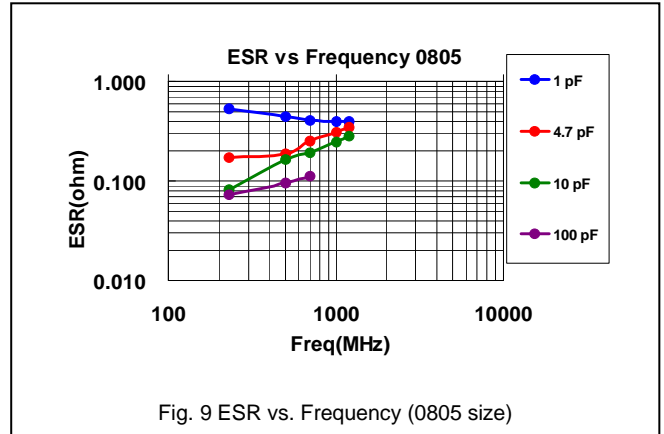
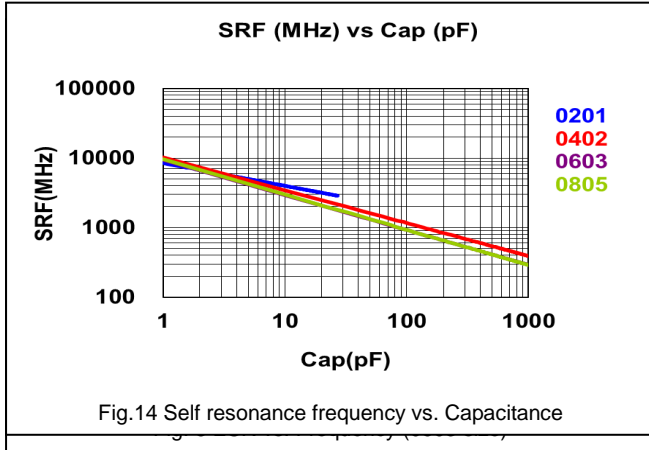

Multilayer Ceramic Capacitors

10. RELIABILITY TEST CONDITIONS AND REQUIREMENTS

No.	Item	Test Conditions	Requirements
1.	Visual and Mechanical	---	* No remarkable defect. * Dimensions to conform to individual specification sheet.
2.	Capacitance	* Test temp.: Room Temperature.	* Shall not exceed the limits given in the detailed spec.
3.	Q/ D.F. (Dissipation Factor)	* Cap≤1000pF, 1.0±0.2Vrms, 1MHz±10% * Cap>1000pF, 1.0±0.2Vrms, 1KHz±10% * At 25°C ambient temperature.	* NP0: Cap≥30pF, Q≥1000; Cap<30pF, Q≥400+20C
4.	Dielectric Strength	* To apply voltage: (≤100V) 250% of rated voltage. * Duration: 1 to 5 sec. * Charge and discharge current less than 50mA. * To apply voltage: 200V~300V ≥2 times VDC 500V~999V ≥1.5 times VDC * Cut-off, set at 10mA * TEST= 15 sec. * RAMP=0	* No evidence of damage or flash over during test.
5.	Insulation Resistance	* Test temp.: Room Temperature. * Rated voltage:<200V * To apply rated voltage for max. 120 sec. * Test temp.: Room Temperature. * Rated voltage:200~630V * To apply rated voltage (500V max.) for 60 sec.	* ≥10GΩ * ≥10GΩ or RxC≥100Ω-F whichever is smaller
6.	Temperature Coefficient	* With no electrical load. * Operating temperature: -55~125°C at 25°C	* Capacitance change: within ±30ppm/°C
7.	Adhesive Strength of Termination	* Pressurizing force : 2N (0201) and 5N (≤0603) and 10N (>0603) * Test time: 10±1 sec.	* No remarkable damage or removal of the terminations.
8.	Vibration Resistance	* Vibration frequency: 10~55 Hz/min. * Total amplitude: 1.5mm * Test time: 6 hrs. (Two hrs each in three mutually perpendicular directions.) * Cap./DF(Q) Measurement to be made after de-aging at 150°C for 1hr then set for 24±2 hrs at room temp.	* No remarkable damage. * Cap change and Q/D.F.: To meet initial spec.
9.	Solderability	* Solder temperature: 235±5°C * Dipping time: 2±0.5 sec.	* 95% min. coverage of all metalized area.
10.	Bending Test	* The middle part of substrate shall be pressurized by means of the pressurizing rod at a rate of about 1 mm per second until the deflection becomes 1 mm and then the pressure shall be maintained for 5±1 sec. * Measurement to be made after keeping at room temp. for 24±2 hrs.	* No remarkable damage. * Cap change: within ±5.0% or ±0.5pF whichever is larger. (This capacitance change means the change of capacitance under specified flexure of substrate from the capacitance measured before the test.)
11.	Resistance to Soldering Heat	* Solder temperature: 260±5°C * Dipping time: 10±1 sec * Preheating: 120 to 150°C for 1 minute before immerse the capacitor in a eutectic solder. * Cap. / DF(Q) / I.R. Measurement to be made after de-aging at 150°C for 1hr then set for 24±2 hrs at room temp .	* No remarkable damage. * Cap change: within ±2.5% or ±0.25pF whichever is larger. * Q/D.F., I.R. and dielectric strength: To meet initial requirements. * 25% max. leaching on each edge.

* "Room condition" Temperature: 15 to 35°C, Relative humidity: 25 to 75%, Atmospheric pressure: 86 to 106kPa.

Multilayer Ceramic Capacitors

No.	Item	Test Condition	Requirements															
12.	Temperature Cycle	<p>* Conduct the five cycles according to the temperatures and time.</p> <table border="1"> <thead> <tr> <th>Step</th> <th>Temp. (°C)</th> <th>Time (min.)</th> </tr> </thead> <tbody> <tr> <td>1</td> <td>Min. operating temp. +0/-3</td> <td>30±3</td> </tr> <tr> <td>2</td> <td>Room temp.</td> <td>2~3</td> </tr> <tr> <td>3</td> <td>Max. operating temp. +3/-0</td> <td>30±3</td> </tr> <tr> <td>4</td> <td>Room temp.</td> <td>2~3</td> </tr> </tbody> </table> <p>* Cap. / DF(Q) / I.R. Measurement to be made after de-aging at 150°C for 1hr then set for 24±2 hrs at room temp.</p>	Step	Temp. (°C)	Time (min.)	1	Min. operating temp. +0/-3	30±3	2	Room temp.	2~3	3	Max. operating temp. +3/-0	30±3	4	Room temp.	2~3	<p>No remarkable damage.</p> <p>Cap change : within ±2.5% or ±0.25pF whichever is larger.</p> <p>* Q/D.F., I.R. and dielectric strength: To meet initial requirements.</p>
Step	Temp. (°C)	Time (min.)																
1	Min. operating temp. +0/-3	30±3																
2	Room temp.	2~3																
3	Max. operating temp. +3/-0	30±3																
4	Room temp.	2~3																
13.	Humidity (Damp Heat) Steady State	<p>* Test temp.: 40±2°C</p> <p>* Humidity: 90~95% RH</p> <p>* Test time: 500+24/-0hrs.</p> <p>* Cap. / DF(Q) / I.R. Measurement to be made after de-aging at 150°C for 1hr then set for 24±2 hrs at room temp.</p>	<p>* No remarkable damage.</p> <p>* Cap change: within ±5.0% or ±0.5pF whichever is larger.</p> <p>* Q/D.F. value: NP0: Cap≥30pF, Q≥350; 10pF≤Cap<30pF, Q≥275+2.5C Cap<10pF; Q≥200+10C</p> <p>* I.R.: ≥1GΩ or RxC≥50Ω-F whichever is smaller.</p>															
14.	Humidity (Damp Heat) Load	<p>* Test temp.: 40±2°C</p> <p>* Humidity: 90~95%RH</p> <p>* Test time: 500+24/-0 hrs.</p> <p>* To apply voltage : rated voltage (Max. 500V)</p> <p>* Cap. / DF(Q) / I.R. Measurement to be made after de-aging at 150°C for 1hr then set for 24±2 hrs at room temp.</p>	<p>* No remarkable damage.</p> <p>* Cap change: within ±7.5% or ±0.75pF whichever is larger.</p> <p>* Q/D.F. value: NP0: Cap≥30pF, Q≥200; Cap<30pF, Q≥100+10/3C</p> <p>* I.R.: ≥500MΩ or RxC≥25Ω-F whichever is smaller.</p>															
15.	High Temperature Load (Endurance)	<p>* Test temp.: NP0: 125±3°C</p> <p>* To apply voltage: (1) <500V: 200% of rated voltage. (2) 500V: 150% of rated voltage. (3) ≥630V: 120% of rated voltage.</p> <p>* Test time: 1000+24/-0 hrs.</p> <p>* Cap. / DF(Q) / I.R. Measurement to be made after de-aging at 150°C for 1hr then set for 24±2 hrs at room temp.</p>	<p>* No remarkable damage.</p> <p>* Cap change: within ±3.0% or ±0.3pF whichever is larger.</p> <p>* Q/D.F. value: NP0: Cap≥30pF, Q≥350 10pF≤Cap<30pF, Q≥275+2.5C Cap<10pF, Q≥200+10C</p> <p>* I.R.: ≥1GΩ or RxC≥50Ω-F whichever is smaller.</p>															

* "Room condition" Temperature: 15 to 35°C, Relative humidity: 25 to 75%, Atmospheric pressure: 86 to 106kPa.

Multilayer Ceramic Capacitors

APPENDIXES

▣ Tape & reel dimensions

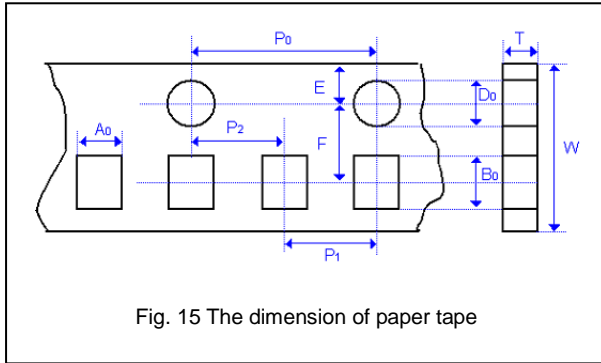

Fig. 15 The dimension of paper tape

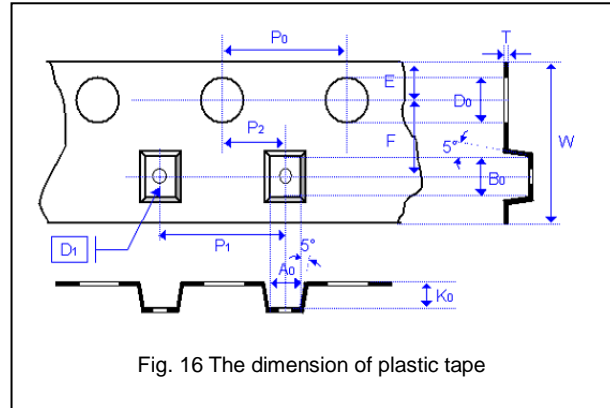

Fig. 16 The dimension of plastic tape

Size	0201	0402	0603	0805		
Thickness	L	N	S, X	A	B	C, D, I
A ₀	0.40 +/-0.10	0.70 +/-0.20	1.05 +/-0.30	1.50 +/-0.20	1.50 +/-0.20	< 1.80
B ₀	0.70 +/-0.10	1.20 +/-0.20	1.80 +/-0.30	2.30 +/-0.20	2.30 +/-0.20	< 2.70
T	≤ 0.55	≤ 0.80	≤ 1.20	≤ 1.15	≤ 1.20	0.23 +/-0.1
K ₀	-	-	-	-	-	< 2.00
W	8.00 +/-0.30	8.00 +/-0.30	8.00 +/-0.30	8.00 +/-0.30	8.00 +/-0.30	8.00 +/-0.30
P ₀	4.00 +/-0.10	4.00 +/-0.10	4.00 +/-0.10	4.00 +/-0.10	4.00 +/-0.10	4.00 +/-0.10
10xP ₀	40.00 +/-0.10	40.00 +/-0.10	40.00 +/-0.20	40.00 +/-0.20	40.00 +/-0.20	40.00 +/-0.20
P ₁	2.00 +/-0.05	2.00 +/-0.05	4.00 +/-0.10	4.00 +/-0.10	4.00 +/-0.10	4.00 +/-0.10
P ₂	2.00 +/-0.05	2.00 +/-0.05	2.00 +/-0.05	2.00 +/-0.05	2.00 +/-0.05	2.00 +/-0.05
D ₀	1.50 +0.1/-0	1.50 +0.1/-0	1.50 +0.1/-0	1.50 +0.1/-0	1.50 +0.1/-0	1.50 +0.1/-0
D ₁	-	-	-	-	-	1.00 +/-0.10
E	1.75 +/-0.10	1.75 +/-0.10	1.75 +/-0.10	1.75 +/-0.10	1.75 +/-0.10	1.75 +/-0.10
F	3.50 +/-0.05	3.50 +/-0.05	3.50 +/-0.05	3.50 +/-0.05	3.50 +/-0.05	3.50 +/-0.05

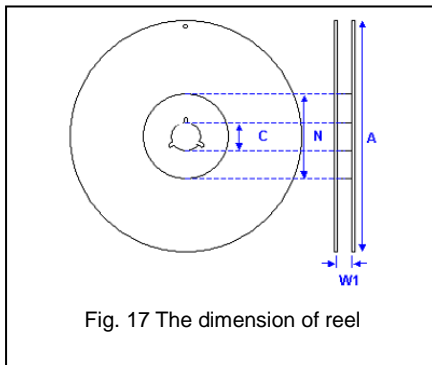
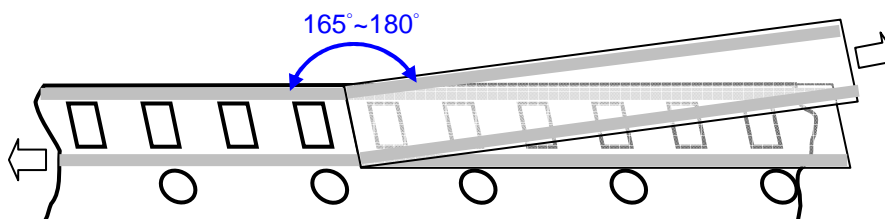

Fig. 17 The dimension of reel

Size	0201, 0402, 0603, 0805		
Reel size	7"	10"	13"
C	13.0±0.5	13.0±0.5	13.0±0.5
W ₁	10.0±1.5	10.0±1.5	10.0±1.5
A	178.0±2.0	250.0±2.0	330.0±2.0
N	60.0+1.0/-0	50 min	50 min

▣ Peeling force (EIA-481)

Peel-off force should be in the range of 10 grams to 100 grams at a peel-off speed of 300±10 mm/min.



Multilayer Ceramic Capacitors

Example of customer label

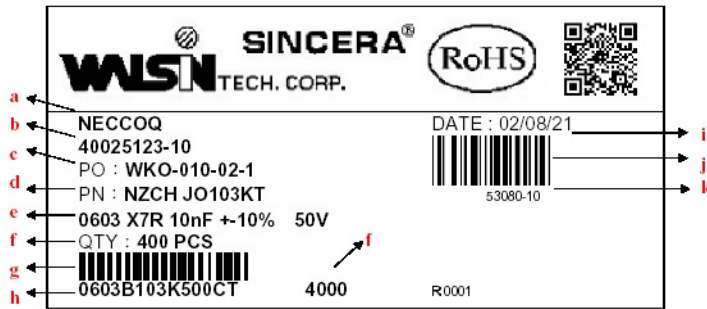

- a. Customer name
- b. WTC order series and item number
- c. Customer P/O
- d. Customer P/N
- e. Description of product
- f. Quantity
- g. Bar code including quantity & WTC P/N or customer
- h. WTC P/N
- i. Shipping date
- j. Order bar code including series and item numbers
- k. Serial number of label

*Customized label is available upon request

Constructions

No.	Name	NPO
①	Ceramic material	CaZrO ₃ based
②	Inner electrode	Ni
③	Termination	Inner layer Cu
④		Middle layer Ni
⑤		Outer layer Sn

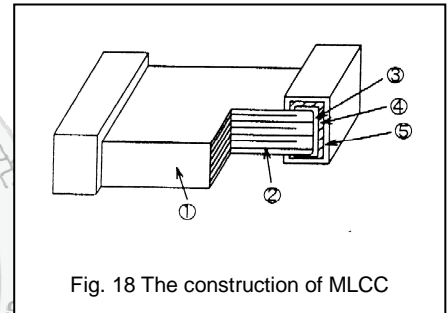

Fig. 18 The construction of MLCC

Storage and handling conditions

- (1) To store products at 5 to 40°C ambient temperature and 20 to 70% related humidity conditions; MSL Level 1.
- (2) The product is recommended to be used within one year after shipment. Check solderability in case of shelf life extension is needed.

Cautions:

- a. The corrosive gas reacts on the terminal electrodes of capacitors, and results in the poor solderability. Do not store the capacitors in the ambience of corrosive gas (e.g., hydrogen sulfide, sulfur dioxide, chlorine, ammonia gas etc.)
- b. In corrosive atmosphere, solderability might be degraded, and silver migration might occur to cause low reliability.
- c. Due to the dewing by rapid humidity change, or the photochemical change of the terminal electrode by direct sunlight, the solderability and electrical performance may deteriorate. Do not store capacitors under direct sunlight or dewing condition. To store products on the shelf and avoid exposure to moisture.

Multilayer Ceramic Capacitors

Recommended soldering conditions

The lead-free termination MLCCs are not only to be used on SMT against lead-free solder paste, but also suitable against lead-containing solder paste. If the optimized solder joint is requested, increasing soldering time, temperature and concentration of N₂ within oven are recommended.

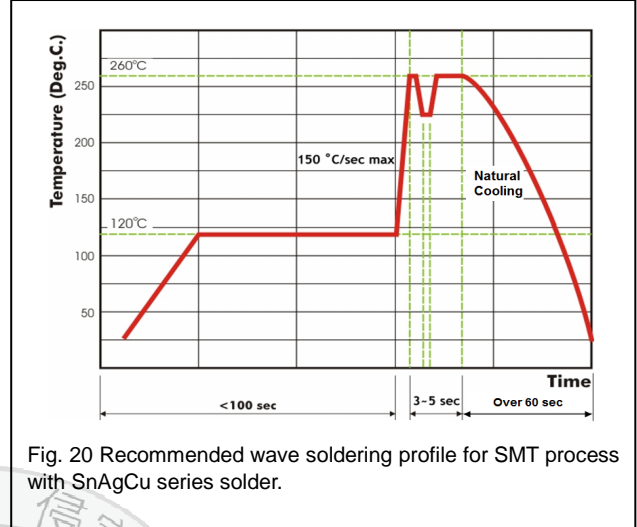
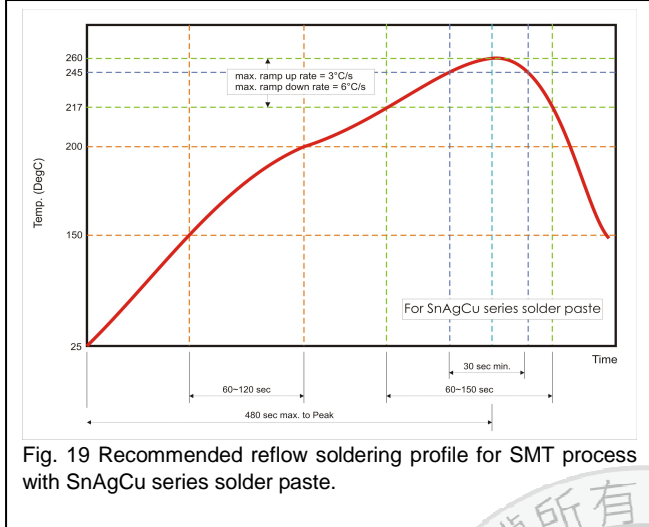

Looking for pricing, stock, or lifecycle information?

Click below to explore more details on WIN SOURCE:

- ⊖ [View HH18N102F500CT on WIN SOURCE](#)
- ⊖ [Walsin Technology Corporation Information](#)

Optimize Your Supply Chain with WIN SOURCE Solutions

- ✓ Global Sourcing Solution
- ✓ Obsolete Management
- ✓ Cost Control Management
- ✓ Shortage Management
- ✓ Alternative Solution
- ✓ Excess Inventory Management