



**THE DATASHEET OF  
IKFW75N65EH5XKSA1**



## TRENCHSTOP™ 5 Advanced Isolation

High speed 5 IGBT in TRENCHSTOP™ 5 technology copacked with RAPID 1 fast and soft antiparallel diode

**Features and Benefits:**

TRENCHSTOP™ 5 technology offering

- Best-in-Class efficiency in hard switching and resonant topologies
- Plug and play replacement of previous generation IGBTs
- 650V breakdown voltage
- Low gate charge  $Q_G$
- Very soft, fast recovery antiparallel diode
- Maximum junction temperature 175°C
- 2500V<sub>RMS</sub> electrical isolation, 50/60Hz, t=1min
- 100% tested isolated mounting surface
- Pb-free lead plating; RoHS compliant
- Complete product spectrum and PSpice Models:  
<http://www.infineon.com/igbt/>

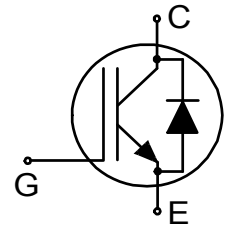

Fully isolated package TO-247

**Potential Applications:**

- Residential and Commercial Aircon PFC
- Welding converters
- Mid to high range switching frequency converters

**Product Validation:**

Qualified for industrial applications according to the relevant tests of JEDEC47/20/22

**Key Performance and Package Parameters**

Type	$V_{CE}$	$I_C$	$V_{CEsat}, T_{vj}=25^{\circ}C$	$T_{vjmax}$	Marking	Package
IKFW75N65EH5	650V	60A	1.65V	175°C	K75EEH5	PG-HSIP247-3-2

### Table of Contents

Description .....	1
Table of Contents .....	2
Maximum Ratings .....	3
Thermal Resistance .....	3
Electrical Characteristics .....	4
Electrical Characteristics Diagrams .....	6
Package Drawing .....	12
Testing Conditions .....	13
Revision History .....	14
Disclaimer .....	15

## TRENCHSTOP™ 5 Advanced Isolation

## Maximum Ratings

For optimum lifetime and reliability, Infineon recommends operating conditions that do not exceed 80% of the maximum ratings stated in this datasheet.

Parameter	Symbol	Value	Unit
Collector-emitter voltage, $T_{vj} \geq 25^{\circ}\text{C}$	$V_{CE}$	650	V
DC collector current, limited by $T_{vjmax}$ $T_h = 25^{\circ}\text{C}$ value limited by bondwire $T_h = 65^{\circ}\text{C}$ $T_h = 65^{\circ}\text{C}$	$I_C$	80.0 66.0 104.0 <sup>1)</sup>	A
Pulsed collector current, $t_p$ limited by $T_{vjmax}$	$I_{Cpuls}$	240.0	A
Turn off safe operating area $V_{CE} \leq 650\text{V}$ , $T_{vj} \leq 175^{\circ}\text{C}$ , $t_p = 1\mu\text{s}$	-	240.0	A
Diode forward current, limited by $T_{vjmax}$ $T_h = 25^{\circ}\text{C}$ value limited by bondwire $T_h = 65^{\circ}\text{C}$	$I_F$	80.0 74.0	A
Diode pulsed current, $t_p$ limited by $T_{vjmax}$	$I_{Fpuls}$	240.0	A
Gate-emitter voltage Transient Gate-emitter voltage ( $t_p \leq 10\mu\text{s}$ , $D < 0.010$ )	$V_{GE}$	$\pm 20$ $\pm 30$	V
Power dissipation $T_h = 25^{\circ}\text{C}$ Power dissipation $T_h = 65^{\circ}\text{C}$	$P_{tot}$	148.0 109.0	W
Operating junction temperature	$T_{vj}$	-40...+175	$^{\circ}\text{C}$
Storage temperature	$T_{stg}$	-55...+150	$^{\circ}\text{C}$
Soldering temperature, wave soldering 1.6mm (0.063in.) from case for 10s		260	$^{\circ}\text{C}$
Mounting torque, M3 screw Maximum of mounting processes: 3	$M$	0.6	Nm
Isolation voltage RMS, $f = 50/60\text{Hz}$ , $t = 1\text{min}^{2)}$	$V_{isol}$	2500	V

## Thermal Resistance

Parameter	Symbol	Conditions	Value			Unit
			min.	typ.	max.	
<b><math>R_{th}</math> Characteristics</b>						
IGBT thermal resistance, <sup>3)</sup> junction - heatsink	$R_{th(j-h)}$		-	0.86	1.01	K/W
Diode thermal resistance, <sup>3)</sup> junction - heatsink	$R_{th(j-h)}$		-	0.97	1.14	K/W
Thermal resistance junction - ambient	$R_{th(j-a)}$		-	-	65	K/W

<sup>1)</sup> Equivalent current rating in TO-247-3 at  $T_h = 65^{\circ}\text{C}$  using reference insulation material: 152 $\mu\text{m}$ , 0.9 W/mK, standard polyimide based reinforced carrier insulator

<sup>2)</sup> For a proper handling and assembly of the advanced isolation device in the application refer to the note at the package drawing.

<sup>3)</sup> At force on body  $F = 500\text{N}$ ,  $T_a = 25^{\circ}\text{C}$

## TRENCHSTOP™ 5 Advanced Isolation

Electrical Characteristic, at  $T_{vj} = 25^{\circ}\text{C}$ , unless otherwise specified

Parameter	Symbol	Conditions	Value			Unit
			min.	typ.	max.	
<b>Static Characteristic</b>						
Collector-emitter breakdown voltage	$V_{(BR)CES}$	$V_{GE} = 0\text{V}, I_C = 0.50\text{mA}$	650	-	-	V
Collector-emitter saturation voltage	$V_{CESat}$	$V_{GE} = 15.0\text{V}, I_C = 60.0\text{A}$ $T_{vj} = 25^{\circ}\text{C}$ $T_{vj} = 175^{\circ}\text{C}$	- -	1.65 1.95	2.10 -	V
Diode forward voltage	$V_F$	$V_{GE} = 0\text{V}, I_F = 60.0\text{A}$ $T_{vj} = 25^{\circ}\text{C}$ $T_{vj} = 175^{\circ}\text{C}$	- -	1.45 1.39	1.70 -	V
Gate-emitter threshold voltage	$V_{GE(th)}$	$I_C = 0.60\text{mA}, V_{CE} = V_{GE}$	3.2	4.0	4.8	V
Zero gate voltage collector current	$I_{CES}$	$V_{CE} = 650\text{V}, V_{GE} = 0\text{V}$ $T_{vj} = 25^{\circ}\text{C}$ $T_{vj} = 175^{\circ}\text{C}$	- -	- -	40 2000	$\mu\text{A}$
Gate-emitter leakage current	$I_{GES}$	$V_{CE} = 0\text{V}, V_{GE} = 20\text{V}$	-	-	100	nA
Transconductance	$g_{fs}$	$V_{CE} = 20\text{V}, I_C = 60.0\text{A}$	-	72.0	-	S

Electrical Characteristic, at  $T_{vj} = 25^{\circ}\text{C}$ , unless otherwise specified

Parameter	Symbol	Conditions	Value			Unit
			min.	typ.	max.	
<b>Dynamic Characteristic</b>						
Input capacitance	$C_{ies}$	$V_{CE} = 25\text{V}, V_{GE} = 0\text{V}$ $f = 1000\text{kHz}$	-	3600	-	pF
Output capacitance	$C_{oes}$		-	105	-	
Reverse transfer capacitance	$C_{res}$		-	13	-	
Gate charge	$Q_G$	$V_{CC} = 520\text{V}, I_C = 60.0\text{A},$ $V_{GE} = 15\text{V}$	-	144.0	-	nC
Internal emitter inductance measured 5mm (0.197 in.) from case	$L_E$		-	13.0	-	nH

## Switching Characteristic, Inductive Load

Parameter	Symbol	Conditions	Value			Unit
			min.	typ.	max.	
<b>IGBT Characteristic, at <math>T_{vj} = 25^{\circ}\text{C}</math></b>						
Turn-on delay time	$t_{d(on)}$	$T_{vj} = 25^{\circ}\text{C},$ $V_{CC} = 400\text{V}, I_C = 60.0\text{A},$ $V_{GE} = 0.0/15.0\text{V},$ $R_{G(on)} = 12.0\Omega, R_{G(off)} = 12.0\Omega,$ $L_{\sigma} = 30\text{nH}, C_{\sigma} = 30\text{pF}$ $L_{\sigma}, C_{\sigma}$ from Fig. E Energy losses include "tail" and diode reverse recovery.	-	30	-	ns
Rise time	$t_r$		-	35	-	ns
Turn-off delay time	$t_{d(off)}$		-	206	-	ns
Fall time	$t_f$		-	42	-	ns
Turn-on energy	$E_{on}$		-	1.80	-	mJ
Turn-off energy	$E_{off}$		-	0.60	-	mJ
Total switching energy	$E_{ts}$		-	2.40	-	mJ

## TRENCHSTOP™ 5 Advanced Isolation

Diode Characteristic, at  $T_{vj} = 25^{\circ}\text{C}$ 

Diode reverse recovery time	$t_{rr}$	$T_{vj} = 25^{\circ}\text{C}$ , $V_R = 400\text{V}$ , $I_F = 60.0\text{A}$ , $di_F/dt = 1000\text{A}/\mu\text{s}$	-	75	-	ns
Diode reverse recovery charge	$Q_{rr}$		-	1.40	-	$\mu\text{C}$
Diode peak reverse recovery current	$I_{rrm}$		-	23.5	-	A
Diode peak rate of fall of reverse recovery current during $t_b$	$di_{rr}/dt$		-	-1150	-	$\text{A}/\mu\text{s}$

## Switching Characteristic, Inductive Load

Parameter	Symbol	Conditions	Value			Unit
			min.	typ.	max.	

IGBT Characteristic, at  $T_{vj} = 150^{\circ}\text{C}$ 

Turn-on delay time	$t_{d(on)}$	$T_{vj} = 150^{\circ}\text{C}$ , $V_{CC} = 400\text{V}$ , $I_C = 60.0\text{A}$ , $V_{GE} = 0.0/15.0\text{V}$ , $R_{G(on)} = 12.0\Omega$ , $R_{G(off)} = 12.0\Omega$ , $L\sigma = 30\text{nH}$ , $C\sigma = 30\text{pF}$ $L\sigma$ , $C\sigma$ from Fig. E Energy losses include "tail" and diode reverse recovery.	-	29	-	ns
Rise time	$t_r$		-	36	-	ns
Turn-off delay time	$t_{d(off)}$		-	228	-	ns
Fall time	$t_f$		-	36	-	ns
Turn-on energy	$E_{on}$		-	2.40	-	mJ
Turn-off energy	$E_{off}$		-	0.72	-	mJ
Total switching energy	$E_{ts}$		-	3.12	-	mJ

Diode Characteristic, at  $T_{vj} = 150^{\circ}\text{C}$ 

Diode reverse recovery time	$t_{rr}$	$T_{vj} = 150^{\circ}\text{C}$ , $V_R = 400\text{V}$ , $I_F = 60.0\text{A}$ , $di_F/dt = 1000\text{A}/\mu\text{s}$	-	118	-	ns
Diode reverse recovery charge	$Q_{rr}$		-	3.40	-	$\mu\text{C}$
Diode peak reverse recovery current	$I_{rrm}$		-	36.5	-	A
Diode peak rate of fall of reverse recovery current during $t_b$	$di_{rr}/dt$		-	-1700	-	$\text{A}/\mu\text{s}$

TRENCHSTOP™ 5 Advanced Isolation

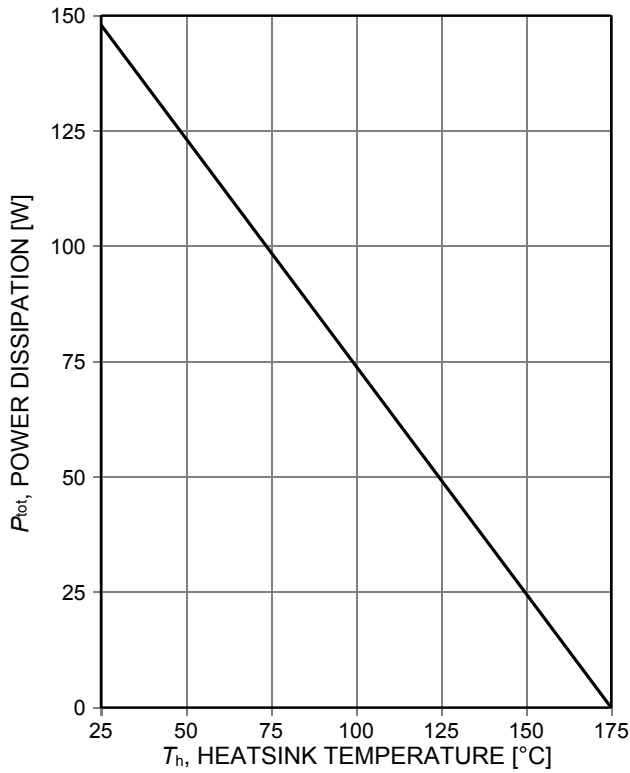

Figure 1. Power dissipation as a function of heatsink temperature ( $T_j \leq 175^\circ\text{C}$ )

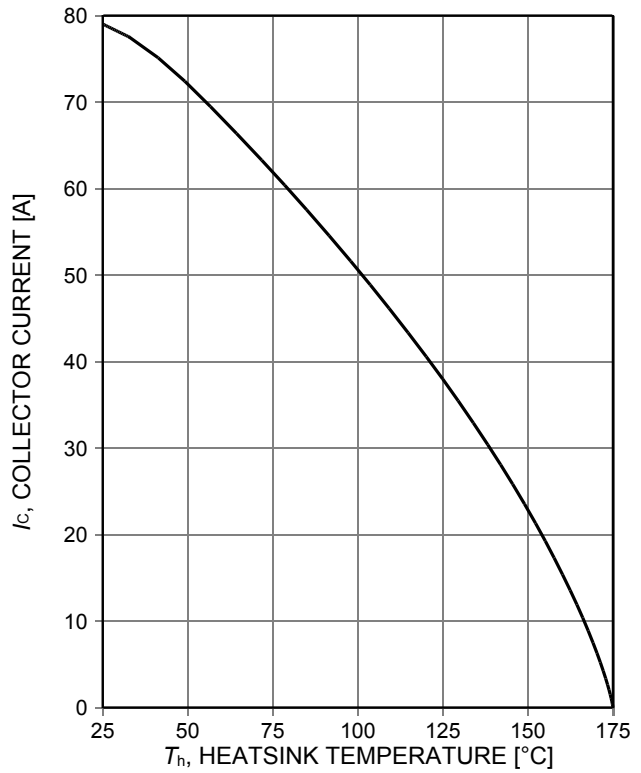

Figure 2. Collector current as a function of heatsink temperature ( $V_{GE} \geq 15\text{V}$ ,  $T_j \leq 175^\circ\text{C}$ )

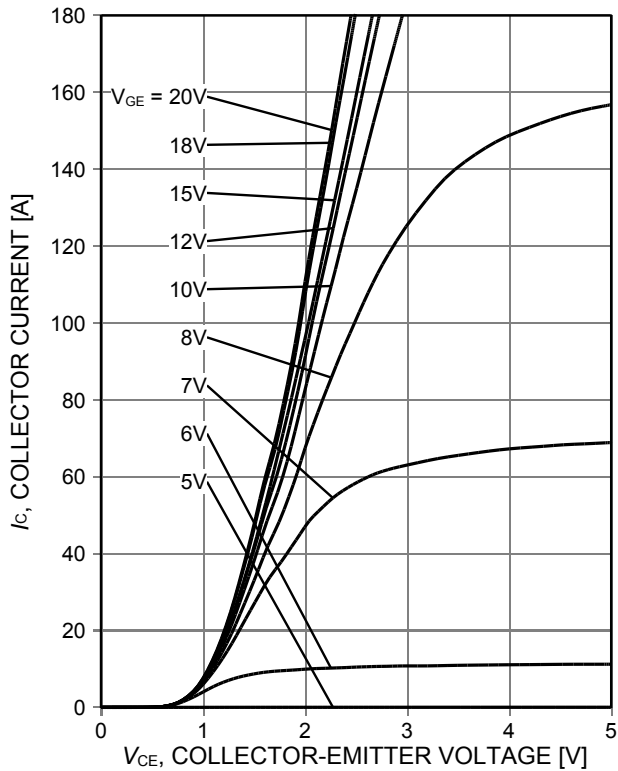

Figure 3. Typical output characteristic ( $T_j = 25^\circ\text{C}$ )

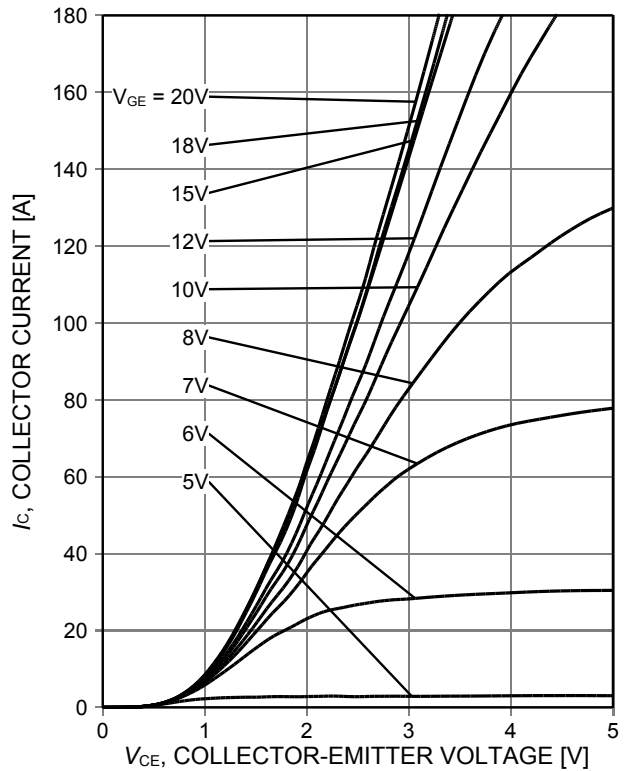

Figure 4. Typical output characteristic ( $T_j = 175^\circ\text{C}$ )

TRENCHSTOP™ 5 Advanced Isolation

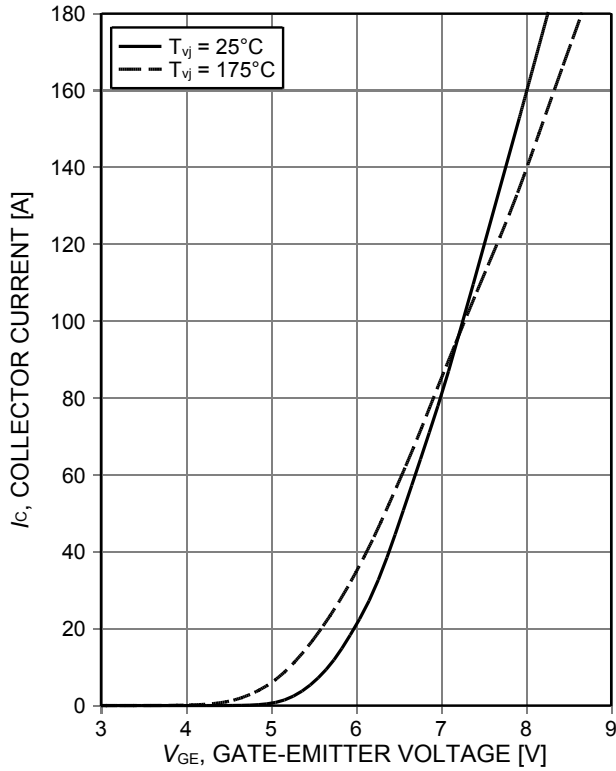

Figure 5. Typical transfer characteristic ( $V_{CE}=20V$ )

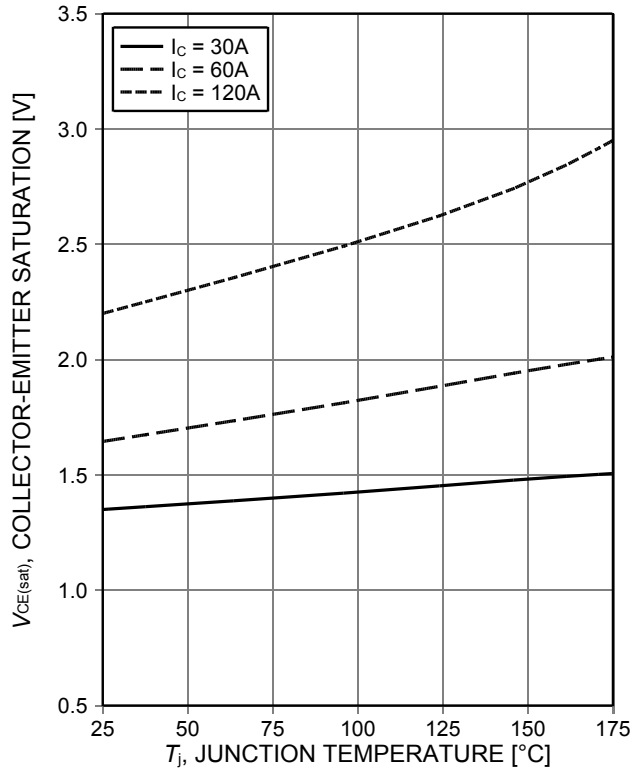

Figure 6. Typical collector-emitter saturation voltage as a function of junction temperature ( $V_{GE}=15V$ )

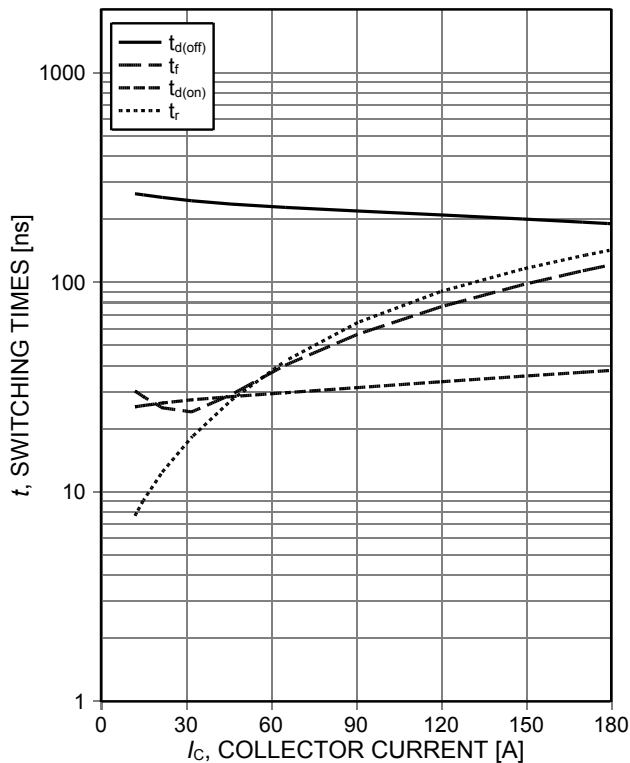

Figure 7. Typical switching times as a function of collector current (ind. load,  $T_j=150^\circ C$ ,  $V_{CE}=400V$ ,  $V_{GE}=0/15V$ ,  $R_G=12\Omega$ , test circuit in Fig. E)

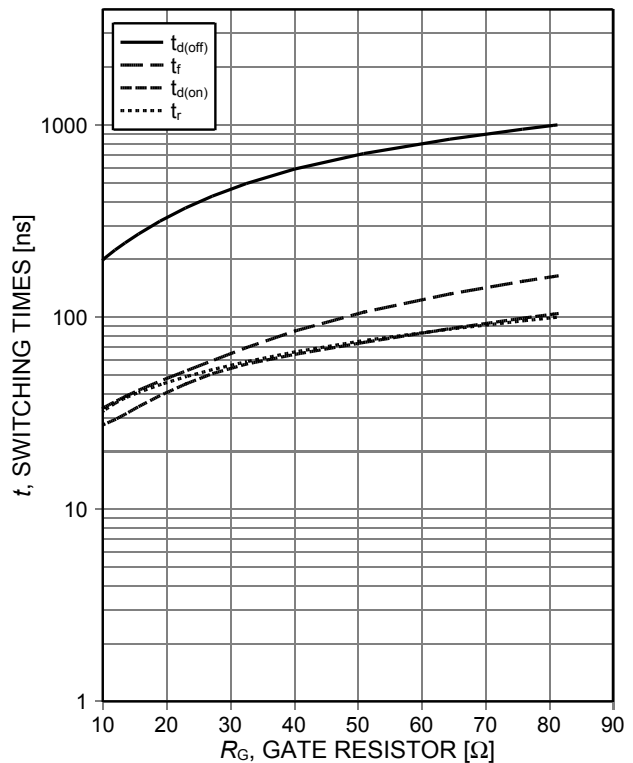

Figure 8. Typical switching times as a function of gate resistor (ind. load,  $T_j=150^\circ C$ ,  $V_{CE}=400V$ ,  $V_{GE}=0/15V$ ,  $I_C=60A$ , test circuit in Fig. E)

TRENCHSTOP™ 5 Advanced Isolation

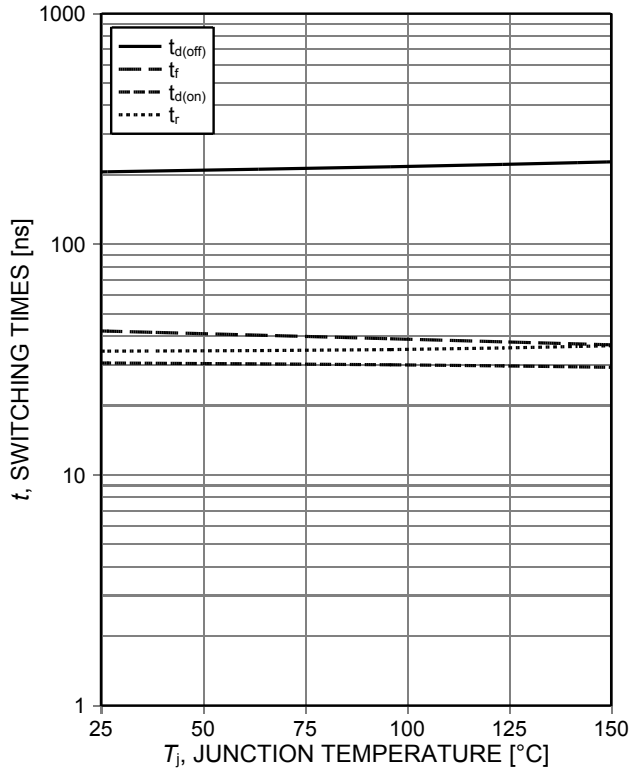

Figure 9. Typical switching times as a function of junction temperature (ind. load,  $V_{CE}=400V$ ,  $V_{GE}=0/15V$ ,  $I_C=60A$ ,  $r_G=12\Omega$ , test circuit in Fig. E)

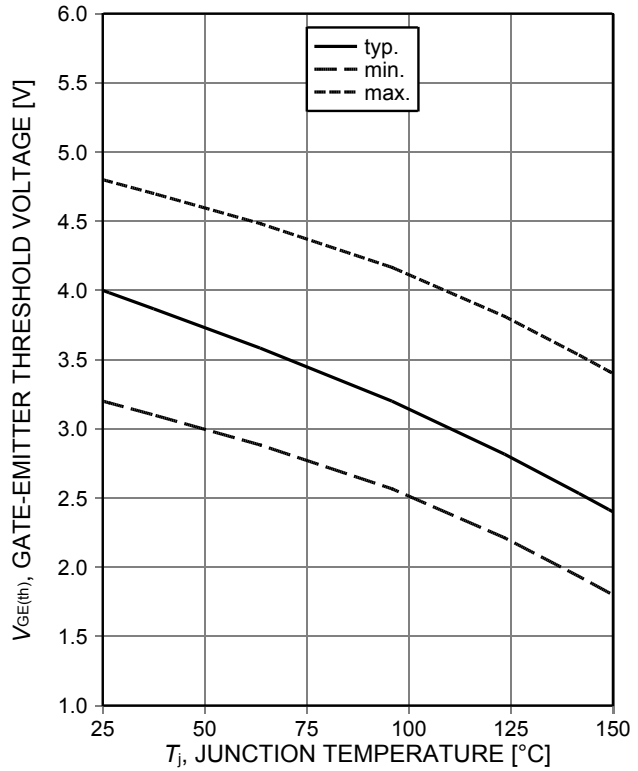

Figure 10. Gate-emitter threshold voltage as a function of junction temperature ( $I_C=0.6mA$ )

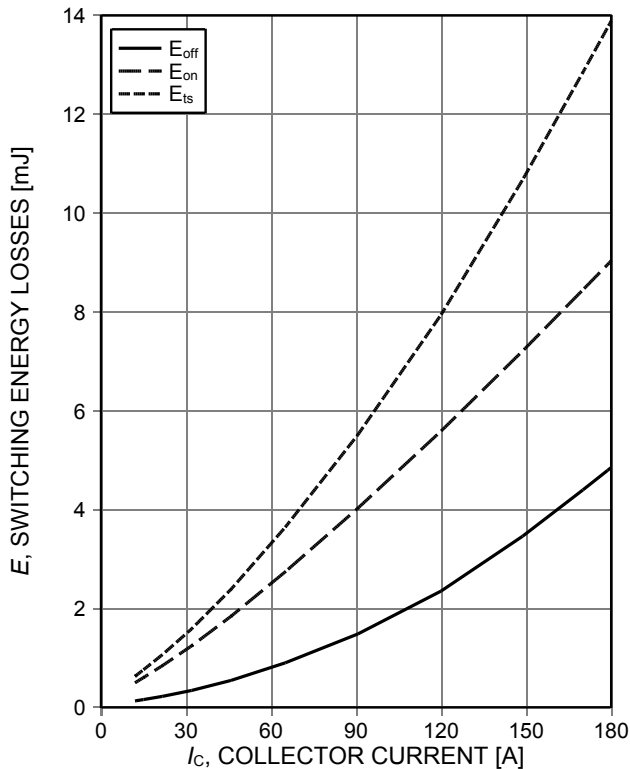

Figure 11. Typical switching energy losses as a function of collector current (ind. load,  $T_j=150^\circ C$ ,  $V_{CE}=400V$ ,  $V_{GE}=0/15V$ ,  $R_G=12\Omega$ , test circuit in Fig. E)

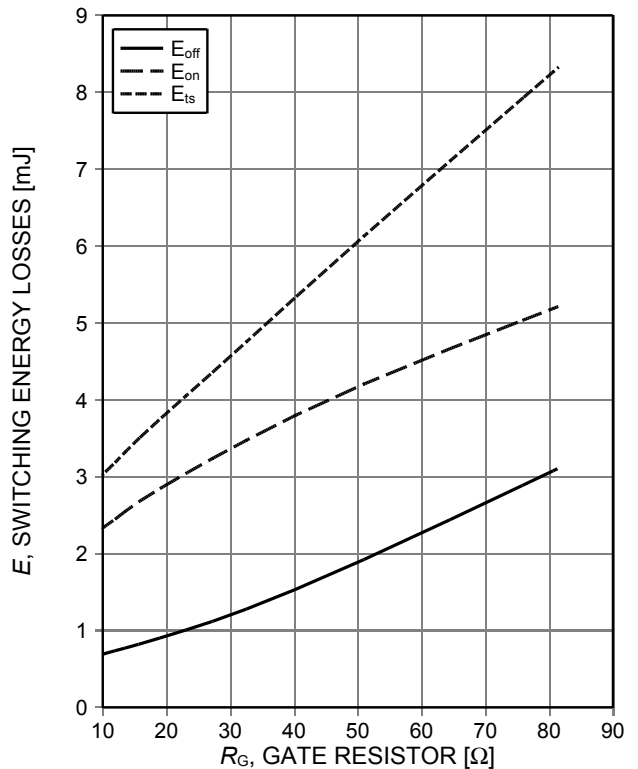

Figure 12. Typical switching energy losses as a function of gate resistor (ind. load,  $T_j=150^\circ C$ ,  $V_{CE}=400V$ ,  $V_{GE}=0/15V$ ,  $I_C=60A$ , test circuit in Fig. E)

TRENCHSTOP™ 5 Advanced Isolation

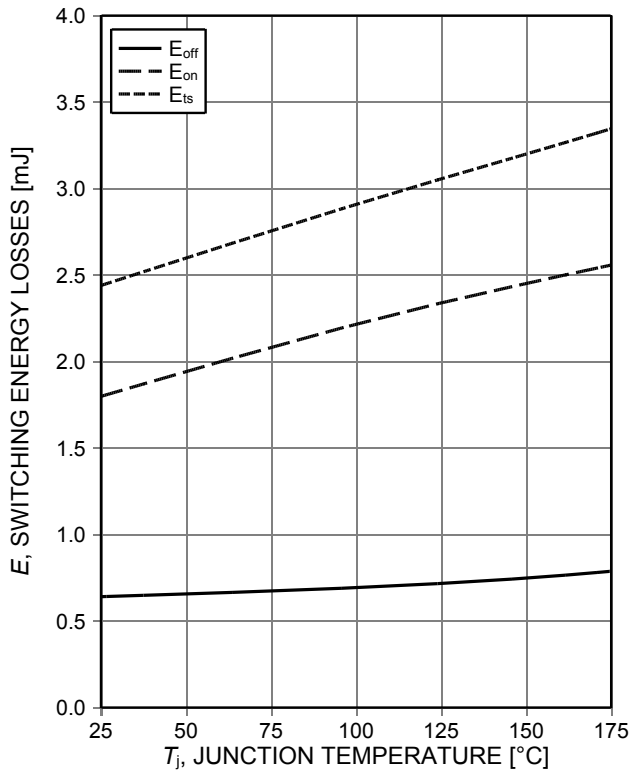

Figure 13. Typical switching energy losses as a function of junction temperature (ind load,  $V_{CE}=400V$ ,  $V_{GE}=0/15V$ ,  $I_C=60A$ ,  $R_G=12\Omega$ , test circuit in Fig. E)

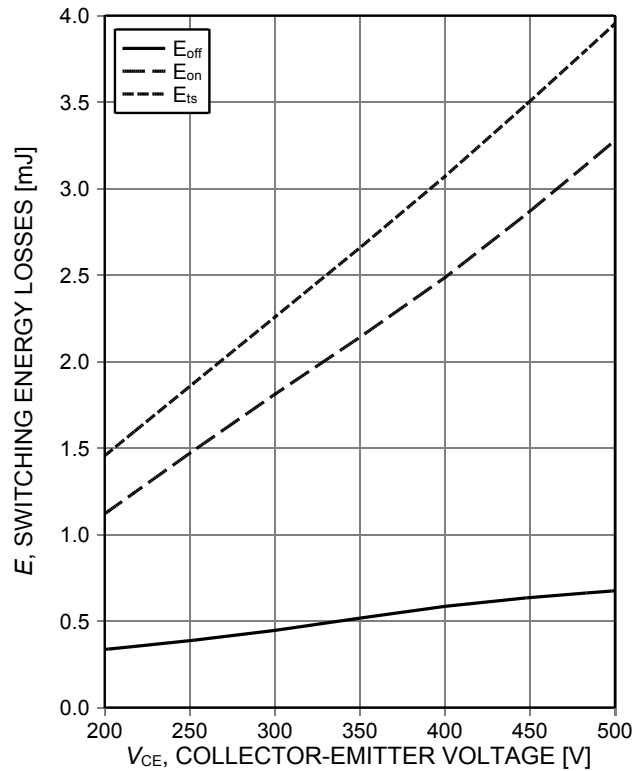

Figure 14. Typical switching energy losses as a function of collector emitter voltage (ind load,  $T_j=150^\circ C$ ,  $V_{GE}=0/15V$ ,  $I_C=60A$ ,  $R_G=12\Omega$ , test circuit in Fig. E)

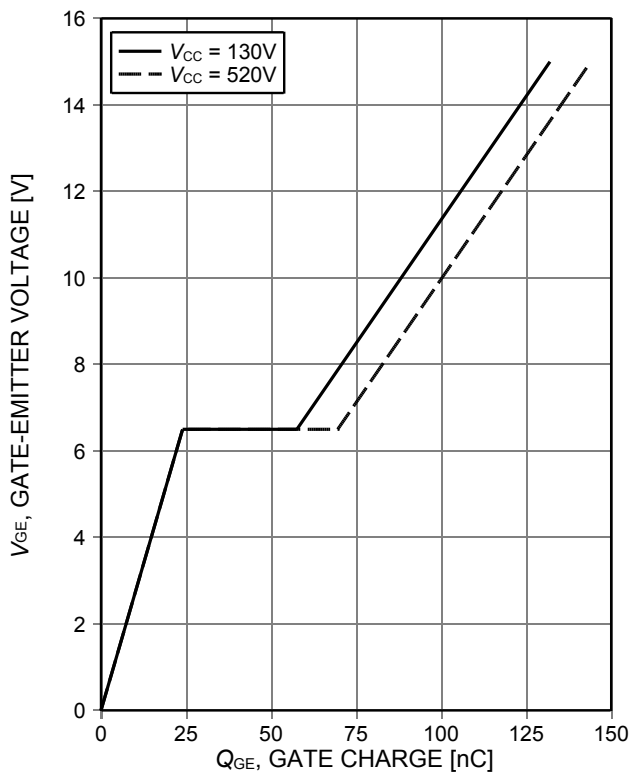

Figure 15. Typical gate charge ( $I_C=60A$ )

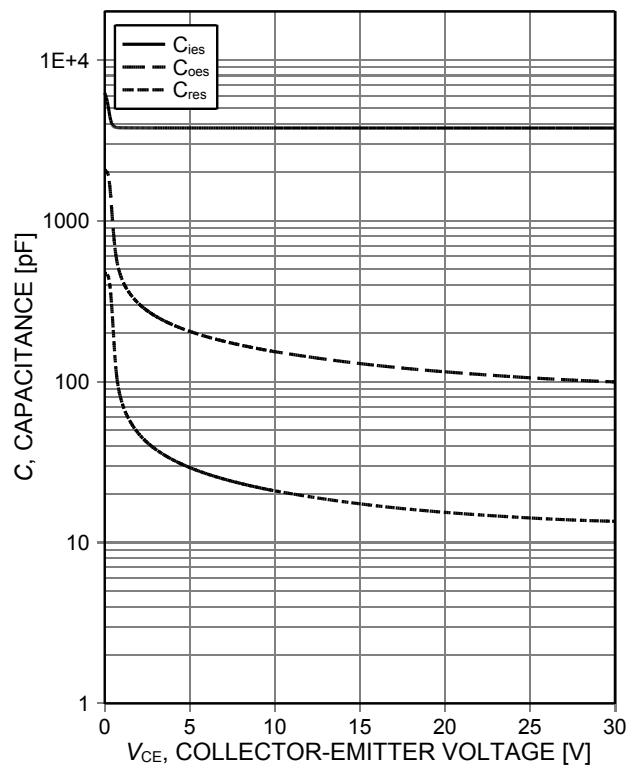

Figure 16. Typical capacitance as a function of collector-emitter voltage ( $V_{GE}=0V$ ,  $f=1MHz$ )

TRENCHSTOP™ 5 Advanced Isolation

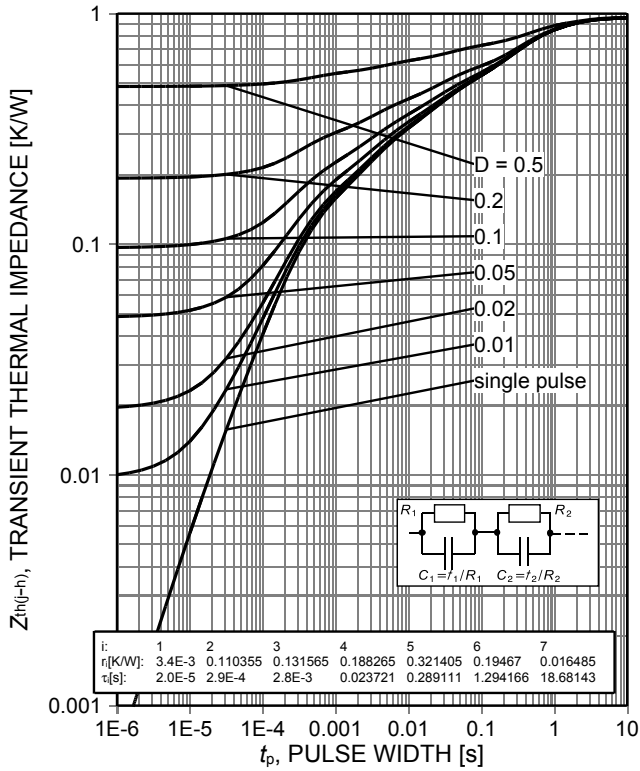

Figure 17. IGBT transient thermal impedance as a function of pulse width ( $D=t_p/T$ )

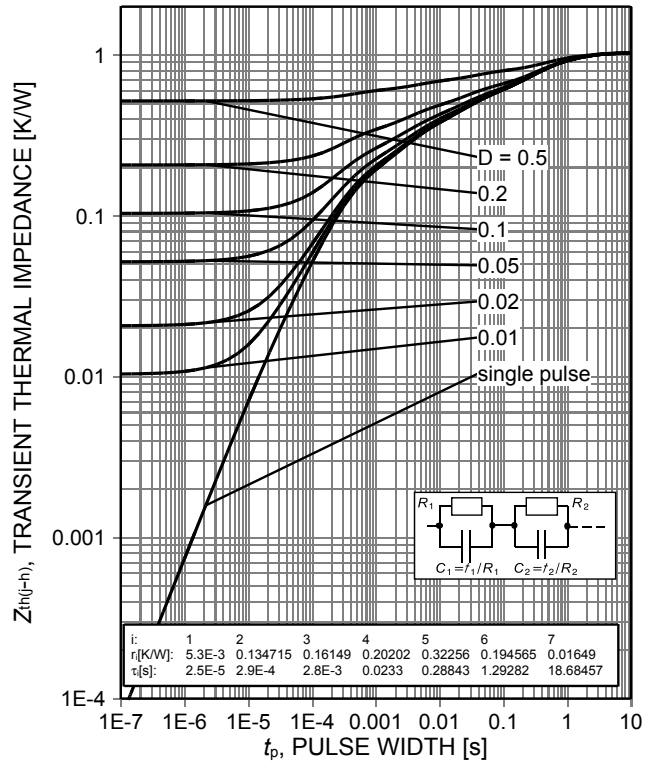

Figure 18. Diode transient thermal impedance as a function of pulse width ( $D=t_p/T$ )

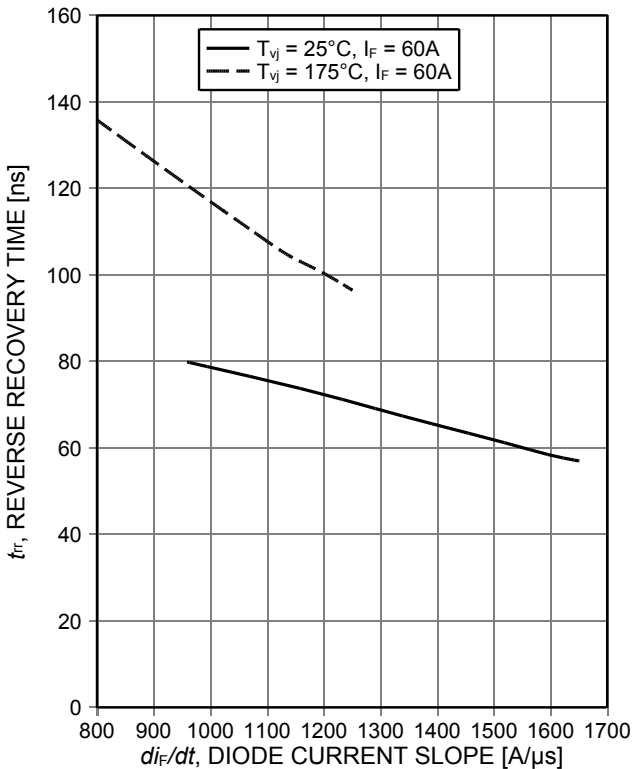

Figure 19. Typical reverse recovery time as a function of diode current slope ( $V_R=400V$ )

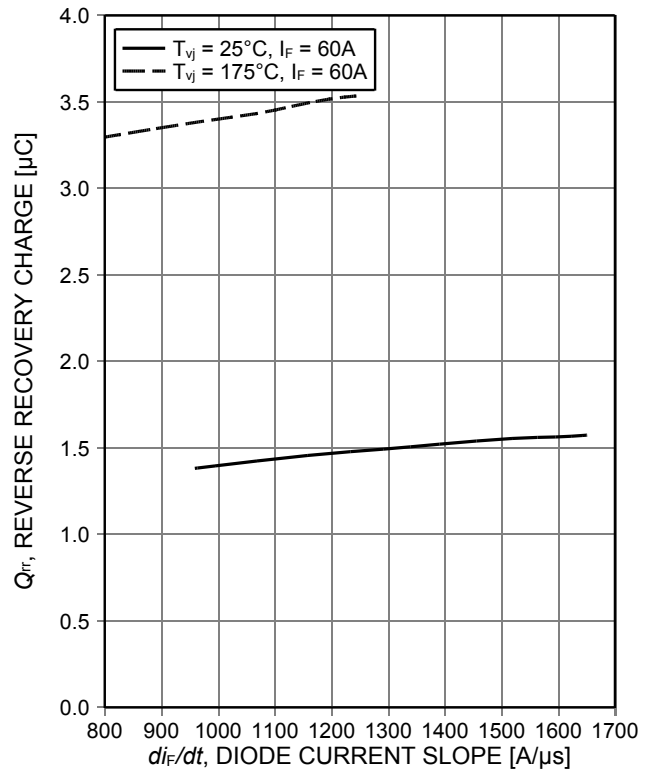

Figure 20. Typical reverse recovery charge as a function of diode current slope ( $V_R=400V$ )

TRENCHSTOP™ 5 Advanced Isolation

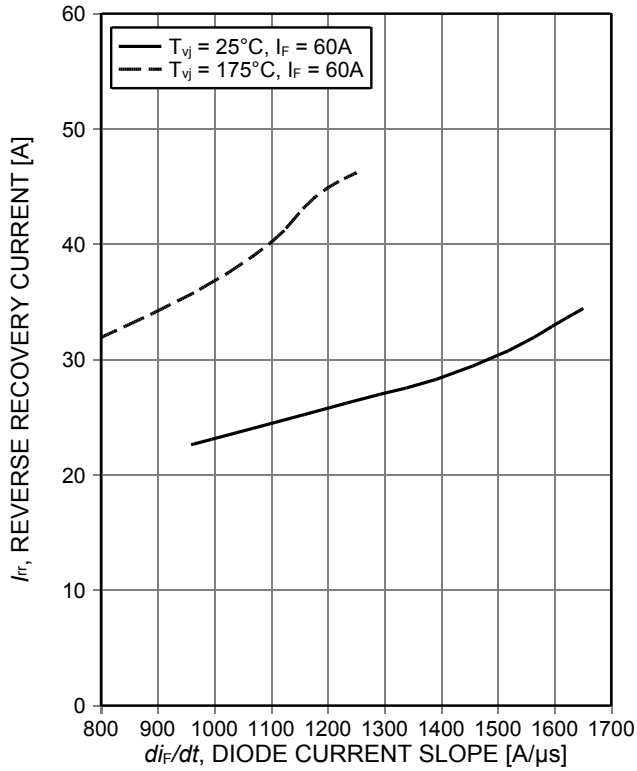

Figure 21. Typical reverse recovery current as a function of diode current slope (V<sub>R</sub>=400V)

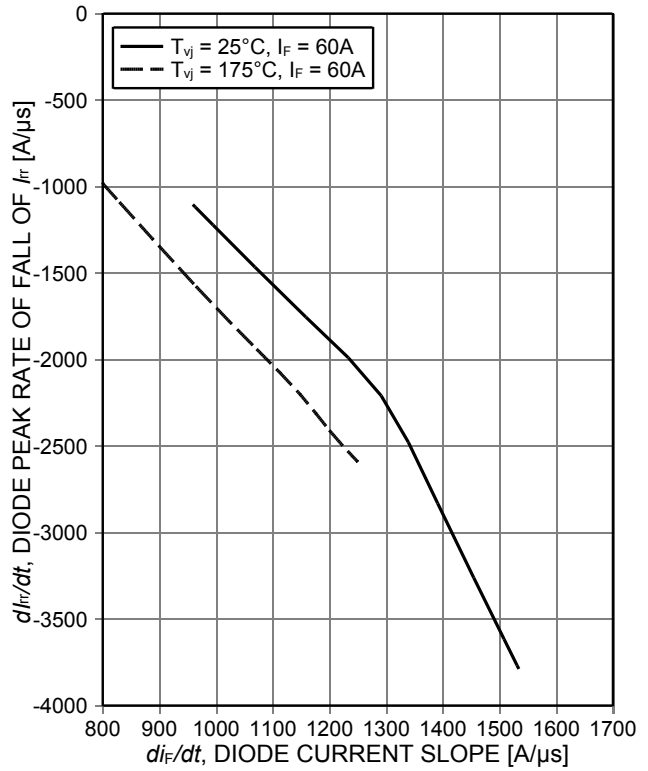

Figure 22. Typical diode peak rate of fall of reverse recovery current as a function of diode current slope (V<sub>R</sub>=400V)

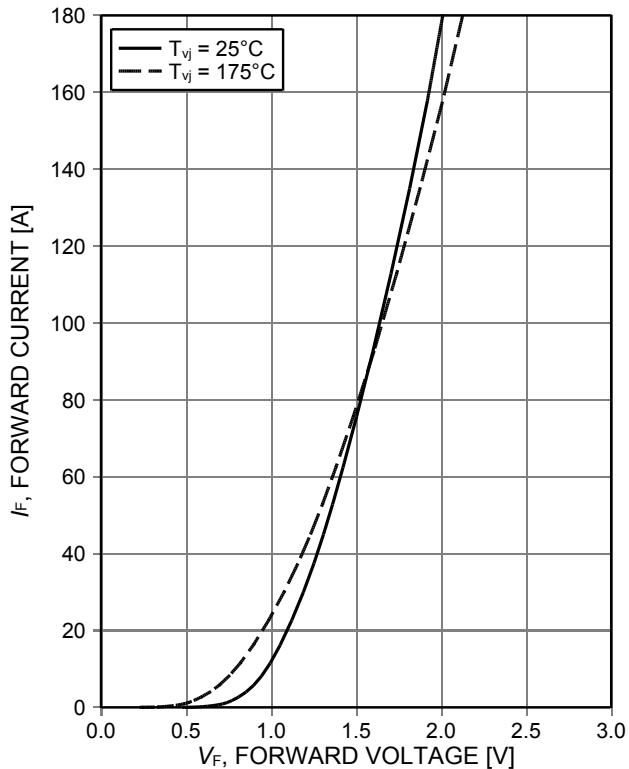

Figure 23. Typical diode forward current as a function of forward voltage

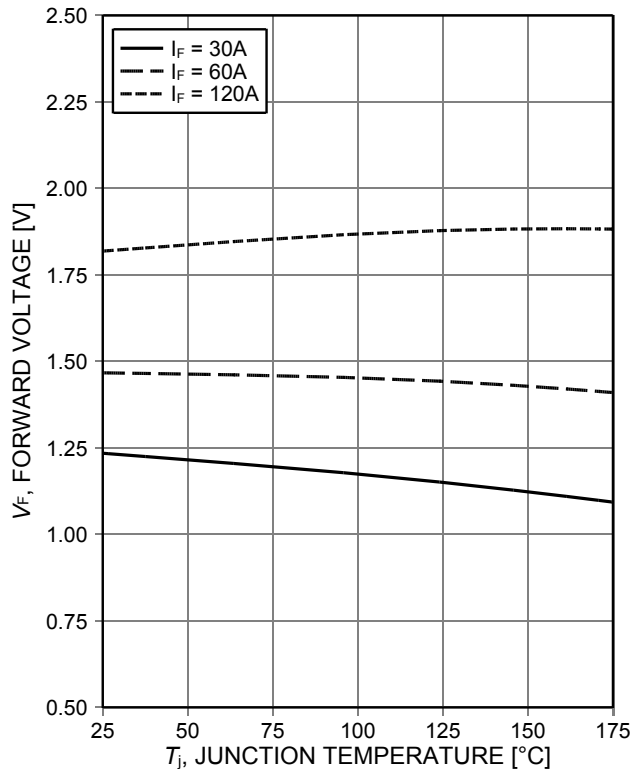
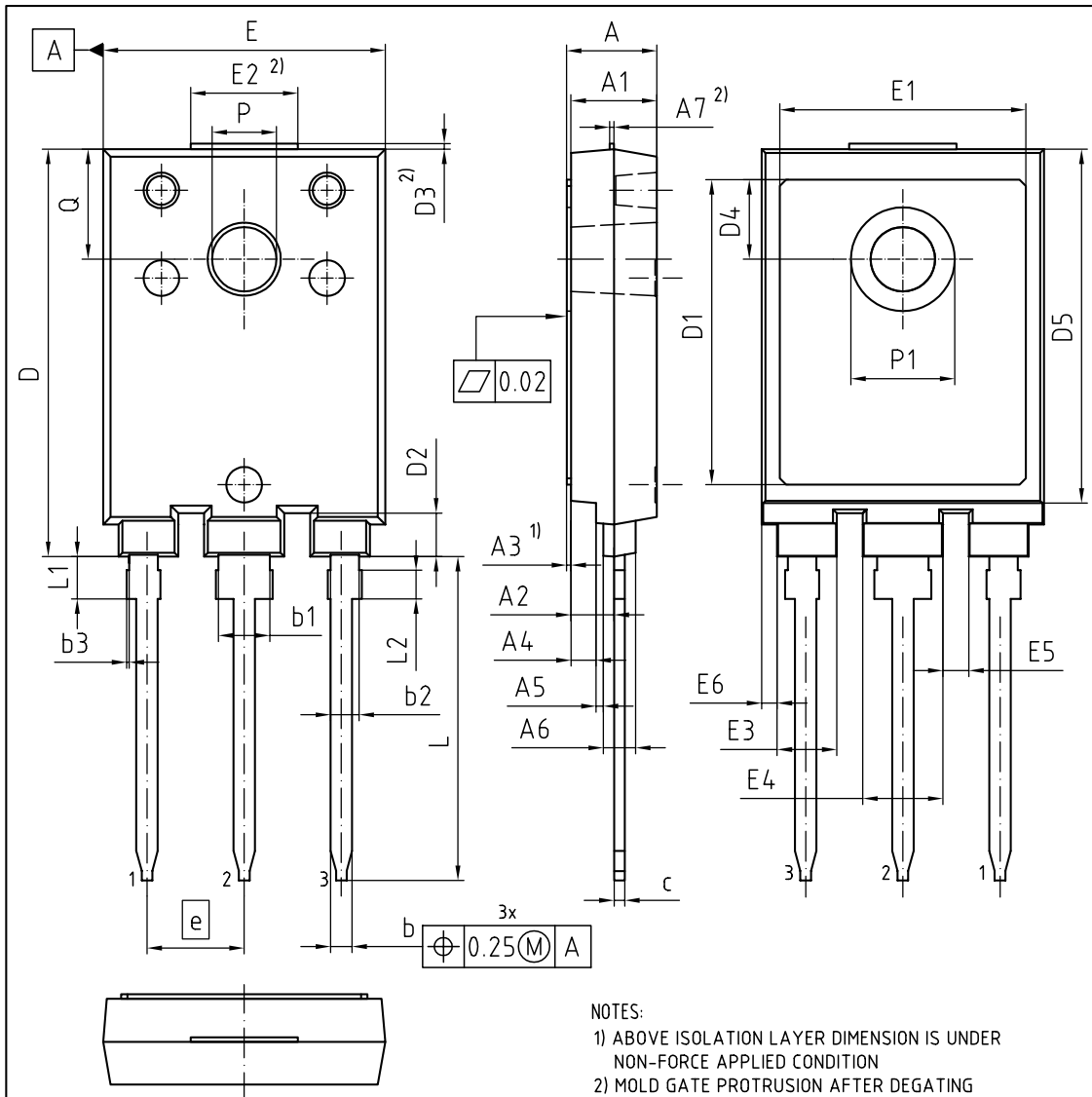

Figure 24. Typical diode forward voltage as a function of junction temperature

**PG-HSIP247-3-2**



NOTES:  
 1) ABOVE ISOLATION LAYER DIMENSION IS UNDER NON-FORCE APPLIED CONDITION  
 2) MOLD GATE PROTRUSION AFTER DEGATING  
 ALL METAL SURFACES TIN PLATED EXCEPT AREA OF CUT

DIMENSIONS	MILLIMETERS		DIMENSIONS	MILLIMETERS	
	MIN.	MAX.		MIN.	MAX.
A	-	5.18	e	5.44	
A1	4.70	4.90	E	15.70	15.90
A2	2.16	2.66	E1	13.68	13.88
A3	0.20	0.28	E2	(6.00)	
A4	1.30	1.50	E3	3.24	3.44
A5	0.31	0.51	E4	4.39	4.59
A6	1.70	1.90	E5	(1.45)	
A7	(0.25)		E6	0.76	0.96
b	1.10	1.30	L	18.01	18.21
b1	(2.88)		L1	2.26	2.46
b2	(1.60)		L2	1.50	1.70
b3	-	0.15	P	3.50	3.70
c	0.50	0.70	P1	5.70	5.90
D	22.70	22.90	Q	6.06	6.26
D1	16.96	17.16			
D2	2.34	2.54			
D3	-	0.30			
D4	4.35	4.55			
D5	19.70	19.90			

<b>DOCUMENT NO.</b> Z8B00195711
<b>REVISION</b> 01
<b>SCALE 3:1</b> 0 1 2 3 4 5 6 7 8mm 
<b>EUROPEAN PROJECTION</b> 
<b>ISSUE DATE</b> 28.06.2019

Testing Conditions

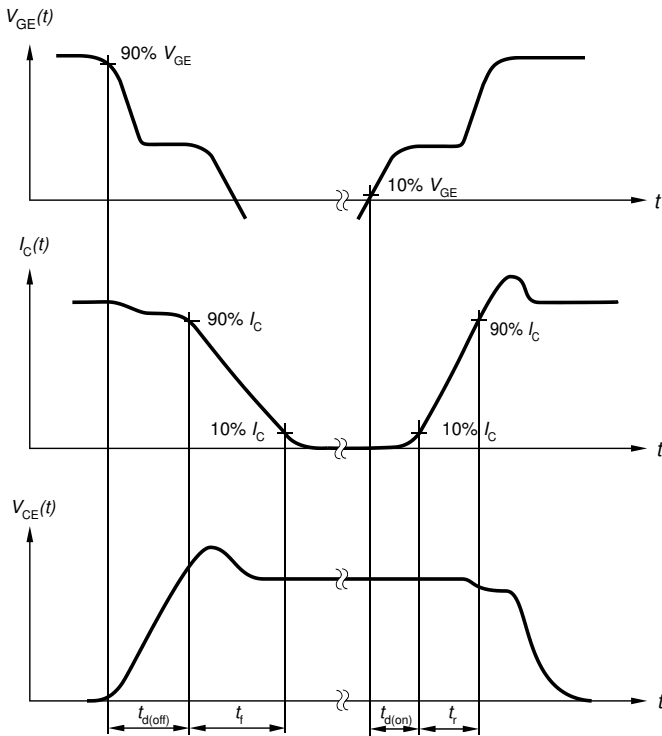

Figure A. Definition of switching times

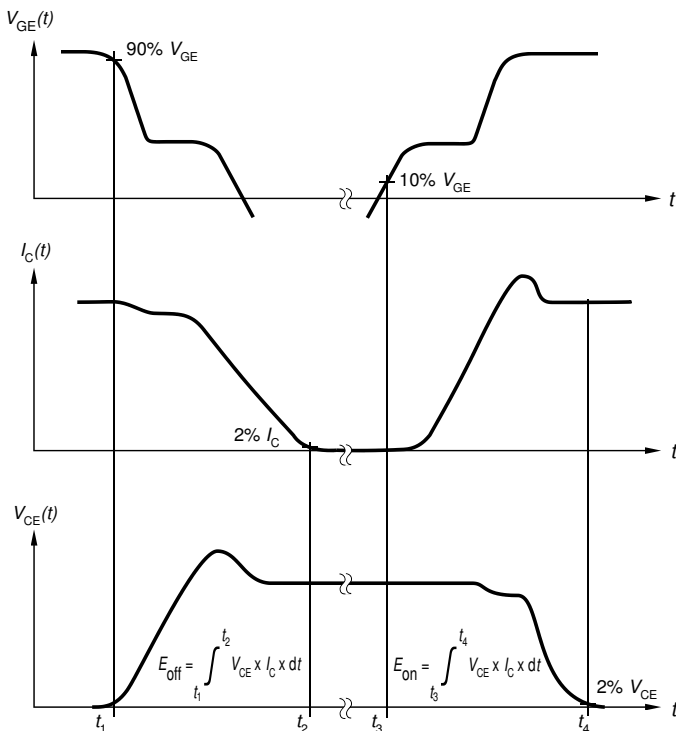

Figure B. Definition of switching losses

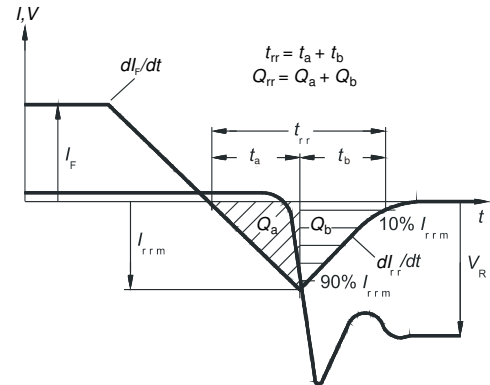

Figure C. Definition of diode switching characteristics

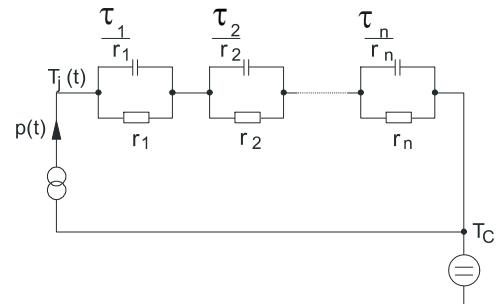

Figure D. Thermal equivalent circuit

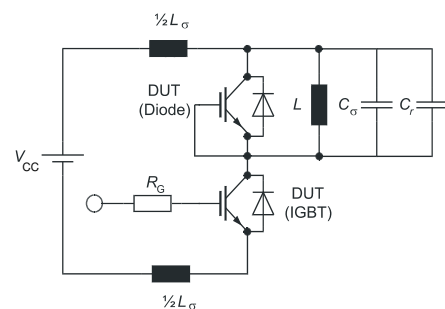

Figure E. Dynamic test circuit  
Parasitic inductance  $L_{\sigma}$ ,  
parasitic capacitor  $C_{\sigma}$ ,  
relief capacitor  $C_r$ ,  
(only for ZVT switching)

## Revision History

---

IKFW75N65EH5

**Revision: 2020-07-24, Rev. 2.1**

---

Previous Revision

---

Revision	Date	Subjects (major changes since last revision)
2.1	2020-07-24	Final Data Sheet

## Trademarks

All referenced product or service names and trademarks are the property of their respective owners.

**Published by**  
**Infineon Technologies AG**  
**81726 München, Germany**  
**© Infineon Technologies AG 2020.**  
**All Rights Reserved.**

## Important Notice

The information given in this document shall in no event be regarded as a guarantee of conditions or characteristics ("Beschaffenheitsgarantie"). With respect to any examples, hints or any typical values stated herein and/or any information regarding the application of the product, Infineon Technologies hereby disclaims any and all warranties and liabilities of any kind, including without limitation warranties of non-infringement of intellectual property rights of any third party.

In addition, any information given in this document is subject to customer's compliance with its obligations stated in this document and any applicable legal requirements, norms and standards concerning customer's products and any use of the product of Infineon Technologies in customer's applications.

The data contained in this document is exclusively intended for technically trained staff. It is the responsibility of customer's technical departments to evaluate the suitability of the product for the intended application and the completeness of the product information given in this document with respect to such application.

For further information on the product, technology, delivery terms and conditions and prices please contact your nearest Infineon Technologies office ([www.infineon.com](http://www.infineon.com)).

Please note that this product is not qualified according to the AEC Q100 or AEC Q101 documents of the Automotive Electronics Council.



## Warnings

Due to technical requirements products may contain dangerous substances. For information on the types in question please contact your nearest Infineon Technologies office.

Except as otherwise explicitly approved by Infineon Technologies in a written document signed by authorized representatives of Infineon Technologies, Infineon Technologies' products may not be used in any applications where a failure of the product or any consequences of the use thereof can reasonably be expected to result in personal injury.

## Looking for pricing, stock, or lifecycle information?

Click below to explore more details on WIN SOURCE:

-  [View IKFW75N65EH5XKSA1 on WIN SOURCE](#)
-  [Infineon Technologies Information](#)

## Optimize Your Supply Chain with WIN SOURCE Solutions

-  Global Sourcing Solution
-  Obsolete Management
-  Cost Control Management
-  Shortage Management
-  Alternative Solution
-  Excess Inventory Management