



**THE DATASHEET OF
FH12-10S-0.5SVA(54)**



0.5mm and 1mm Pitch FPC/FFC Connectors

FH12 Series

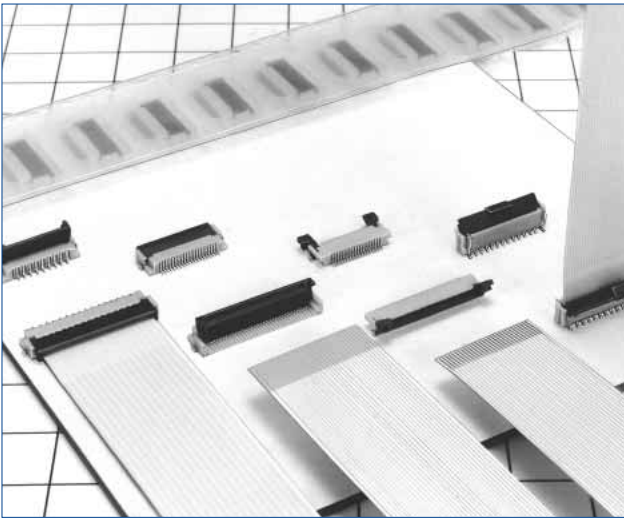

■ Features

1. Rotating one-touch ZIF mechanism

The one-touch rotating ZIF mechanism is easier to operate and works with a light force.

2. Clear tactile click

A clear tactile click is delivered upon the successful completion of the mating process.

3. Supports high density mounting

The FH12's one-touch ZIF system requires less space than a slide locking connector and can be mounted in the center of the PCB.

4. Top & Bottom Contact and Vertical Mount type

There are three connection types available : top contact, bottom contact and a Vertical mount.

5. 1mm pitch product

In addition to the 0.5mm pitch connector, we also offer a 1mm pitch connector.

6. Reinforced actuator

The FH12S version in 30, 40, 45, 50, and 53 pin counts are offered with a reinforced actuator that provides an extra measure of security against actuator breakage.

Rotating one-touch ZIF mechanism

①



②



③



Product Specifications

Rating	Current rating : 0.5A DC(Notes 1)	Operating Temperature Range : -40 to +85°C (Note 2)	Storage Temperature Range : -10 to +50°C (Note 3)
	Voltage rating : 50V AC	Operating Humidity Range : Relative humidity, 90% max. (Not dewed)	Storage Humidity Range : Relative humidity, 90% max. (Not dewed)

Adaptive FPC/FFC contact specifications	t=0.3±0.05 Gold plated
---	------------------------

Item	Specification	Conditions
1. Insulation resistance	500MΩ minimum	100V DC
2. Withstanding voltage	No flashover or insulation breakdown.	150V AC/1 minute
3. Contact resistance	50mΩ maximum	1mA
4. Durability (Insertion/withdrawal)	Contact resistance : 50mΩ maximum No damage, cracks, or parts dislocation.	20 cycles
5. Vibration	No electrical discontinuity of 1μs or more Contact resistance : 50mΩ maximum. No damage, cracks, or parts dislocation.	Frequency : 10 to 55Hz, single amplitude of 0.75mm, for 10 cycles in 3 axial directions
6. Shock	No electrical discontinuity of 1μs or more Contact resistance : 50mΩ maximum. No damage, cracks, or parts dislocation.	Acceleration of 981m/s ² , 6ms duration, sine half-wave waveform, 3 cycles in each of the 3 axis
7. Humidity(Steady state)	Contact resistance : 50mΩ maximum. Insulation resistance : 50MΩ minimum. No damage, cracks, or parts dislocation.	96 hours at 40°C and humidity of 90% to 95%
8. Temperature Cycle	Contact resistance : 50mΩ maximum. Insulation resistance : 50MΩ minimum. No damage, cracks, or parts dislocation.	Temperature : -40°C → 15 to 35°C → 85°C → 15 to 35°C, Time: 30 → 2 to 3 → 30 → 2 to 3(minutes) 5 cycles
9. Resistance to Soldering heat	No deformation of components affecting performance.	Reflow : At the recommended temperature profile Manual soldering : 350±10°C for 5 seconds

Note 1 : When passing the current through all of the contacts, use 70% of the current rating.

Note 2 : Includes temperature rise caused by current flow.

Note 3 : The term "storage" refers to products stored for long period of time prior to mounting and use. Operating Temperature Range and Humidity range covers nonconducting condition of installed connectors in storage, shipment or during transportation.

Materials / Finish

Part	Material	Finish	Remarks
Insulator	Polyamide, LCP(60 pos.)	Color : Beige	UL94V-0
	PPS	Color : Dark brown	
Contact	Phosphor bronze	Gold plated	_____
Metal Fittings	Brass	Tin plated	_____

Product Number Structure

Refer to the chart below when determining the product specifications from the product number.
Please select from the product numbers listed in this catalog when placing orders.

FH 12 A - 10 (4) S A - 0.5 SH ()**

①
②
③
④
⑤
⑥
⑦
⑧
⑨
⑩

① Series Name : FH	⑥ Contact alignment : Single
② Series No. : 12	⑦ Eccentric direction : Blank : standard type A : Eccentric type
③ Blank : standard type A : Top contact type S : Type with strengthened flip-lock actuator	
④ Standard type : Number of contacts Eccentric type : Number of contacts in 0.5mm housing	⑧ Contacts Pitch : 0.5mm, 1mm
⑤ Standard type : Blank Eccentric type : Number of contacts	⑨ Contact type SH : SMT horizontal mounting type SVA : SMT vertical mounting type
	⑩ Plating specification (54) : Selective gold plated (55) : Gold plated (1)(98) : Gold plated 500 pieces/reel

Series Configuration

Pitch	Bottom Contact Type	Top Contact Type	Vertical mounting Type		
0.5mm	 <p>FH12- ** S-0.5SH P.4</p> <p>Number of contacts 6, 8, 10, 11, 12, 13, 14, 15, 16, 17, 18, 19, 20, 22, 24, 25, 26, 28, 30, 32, 33, 34, 35, 36, 40, 45, 50, 53</p>	 <p>FPC insertion port</p> <p>FPC/FFC conductive surface</p>	 <p>FPC/FFC conductive surface(bottom side)</p>		
	<p>Type with Strengthened Lock Lever</p>			<p>FH12A- ** S-0.5SH P.6</p> <p>Number of contacts 10, 12, 15, 16, 18, 20, 22, 24, 26, 28, 29, 30, 32, 33, 34, 36, 40, 42, 45, 50</p>	<p>FH12- ** S-0.5SVA P.7</p> <p>Number of contacts 6, 10, 12, 13, 15, 16, 17, 18, 20, 22, 24, 26, 30, 32, 33, 34, 36, 40, 45, 49, 50, 60</p>
	<p>FH12S- ** S-0.5SH P.5</p> <p>Number of contacts 30, 40, 45, 50, 53</p>				
1mm	 <p>Standard FH12- ** S-1SH P.8</p> <p>Eccentric FH12- ** (***) SA-1SH</p> <p>Standard</p> <p>Number of contacts 5, 6, 7, 8, 9, 11, 12, 16, 17, 22, 26</p> <p>Eccentric</p> <p>Number of contacts 4, 6, 8, 10, 11, 14, 19, 24</p>		 <p>FPC/FFC conductive surface(bottom side)</p> <p>FH12- ** S-1SVA P.9</p> <p>Number of contacts 6, 7, 8, 16, 20, 22, 24</p>		

0.5mm Pitch Bottom Contact Type



- Note 1 : The coplanarity of each terminal lead within specified dimension is 0.1mm Max.
- Note 2 : Packaged on tape and reel only. Check packaging specification.
- Note 3 : Slight variations in color of the plastic compounds do not affect form, fit or function of the connector.
- Note 4 : After reflow, the terminal plating may change color, however this does not represent a quality issue.
- Note ⑤ : If there is no problem with the connector height, we recommend the type with the strengthened Flip-lock actuator (FH12S-*S-0.5SH). Standard type connector height : 2mm Connector height of type with strengthened Flip-lock actuator : 2.4mm

Unit : mm

Part No.	HRS No.	No. of Contacts	A	B	C	D
FH12-6S-0.5SH(**)	586-0582-5 **	6	2.5	6.1	7.1	3.57
FH12-8S-0.5SH(**)	586-0744-5 **	8	3.5	7.1	8.1	4.57
FH12-10S-0.5SH(**)	586-0522-3 **	10	4.5	8.1	9.1	5.57
FH12-11S-0.5SH(**)	586-0600-5 **	11	5.0	8.6	9.6	6.07
FH12-12S-0.5SH(**)	586-0704-0 **	12	5.5	9.1	10.1	6.57
FH12-13S-0.5SH(**)	586-0549-0 **	13	6.0	9.6	10.6	7.07
FH12-14S-0.5SH(**)	586-0533-0 **	14	6.5	10.1	11.1	7.57
FH12-15S-0.5SH(**)	586-0523-6 **	15	7.0	10.6	11.6	8.07
FH12-16S-0.5SH(**)	586-0531-4 **	16	7.5	11.1	12.1	8.57
FH12-17S-0.5SH(**)	586-0606-1 **	17	8.0	11.6	12.6	9.07
FH12-18S-0.5SH(**)	586-0530-1 **	18	8.5	12.1	13.1	9.57
FH12-19S-0.5SH(**)	586-0534-2 **	19	9.0	12.6	13.6	10.07
FH12-20S-0.5SH(**)	586-0524-9 **	20	9.5	13.1	14.1	10.57
FH12-22S-0.5SH(**)	586-0532-7 **	22	10.5	14.1	15.1	11.57
FH12-24S-0.5SH(**)	586-0521-0 **	24	11.5	15.1	16.1	12.57
FH12-25S-0.5SH(**)	586-0692-3 **	25	12.0	15.6	16.6	13.07
FH12-26S-0.5SH(**)	586-0576-2 **	26	12.5	16.1	17.1	13.57
FH12-28S-0.5SH(**)	586-0612-4 **	28	13.5	17.1	18.1	14.57
Note ⑤ FH12-30S-0.5SH(**)	586-0525-1 **	30	14.5	18.1	19.1	15.57
FH12-32S-0.5SH(**)	586-0681-7 **	32	15.5	19.1	20.1	16.57
FH12-33S-0.5SH(**)	586-0520-8 **	33	16.0	19.6	20.6	17.07
FH12-34S-0.5SH(**)	586-0617-8 **	34	16.5	20.1	21.1	17.57
FH12-35S-0.5SH(**)	586-0740-4 **	35	17.0	20.6	21.6	18.07
FH12-36S-0.5SH(**)	586-0526-4 **	36	17.5	21.1	22.1	18.57
Note ⑤ FH12-40S-0.5SH(**)	586-0527-7 **	40	19.5	23.1	24.1	20.57
Note ⑤ FH12-45S-0.5SH(**)	586-0528-0 **	45	22.0	25.6	26.6	23.07
Note ⑤ FH12-50S-0.5SH(**)	586-0529-2 **	50	24.5	28.1	29.1	25.57
Note ⑤ FH12-53S-0.5SH(**)	586-0595-7 **	53	26.0	29.6	30.6	27.07

Note 1 : Embossed tape reel packaging (2,000 pcs/reel, 500 pcs/reel). Order by number of reels.

0.5mm Pitch Bottom Contact Type with Strengthened Flip-lock Actuator

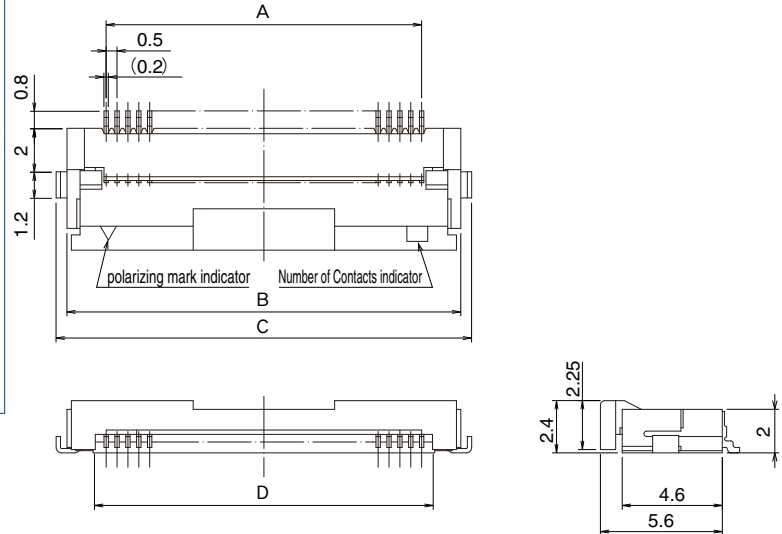
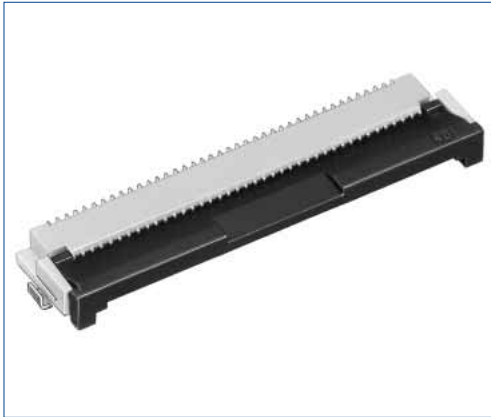

- Note 1 : The coplanarity of each terminal lead within specified dimension is 0.1mm Max.
- Note 2 : Packaged on tape and reel only. Check packaging specification.
- Note 3 : Slight variations in color of the plastic compounds do not affect form, fit or function of the connector.
- Note 4 : After reflow, the terminal plating may change color, however this does not represent a quality issue.

Unit : mm

Part No.	HRS No.	No. of Contacts	A	B	C	D
FH12S-30S-0.5SH(**)	586-0667-6 **	30	14.5	18.1	19.1	15.57
FH12S-40S-0.5SH(**)	586-0640-0 **	40	19.5	23.1	24.1	20.57
FH12S-45S-0.5SH(**)	586-0665-0 **	45	22.0	25.6	26.6	23.07
FH12S-50S-0.5SH(**)	586-0642-5 **	50	24.5	28.1	29.1	25.57
FH12S-53S-0.5SH(**)	586-0691-0 **	53	26.0	29.6	30.6	27.07

- Note 1 : Embossed tape reel packaging (2,000 pcs/reel, 500 pcs/reel).
Order by number of reels.

0.5mm Pitch Top Contact Type



- Note 1 : The coplanarity of each terminal lead within specified dimension is 0.1mm Max.
- Note 2 : Packaged on tape and reel only. Check packaging specification.
- Note 3 : Slight variations in color of the plastic compounds do not affect form, fit or function of the connector.
- Note 4 : After reflow, the terminal plating may change color, however this does not represent a quality issue.

Unit : mm

Part No.	HRS No.	No. of Contacts	A	B	C	D	E
FH12A-10S-0.5SH(**)	586-0550-9 **	10	9.1	8.35	4.5	9.5	5.57
FH12A-12S-0.5SH(**)	586-0696-4 **	12	10.1	9.35	5.5	10.5	6.57
FH12A-15S-0.5SH(**)	586-0551-1 **	15	11.6	10.85	7.0	12.0	8.07
FH12A-16S-0.5SH(**)	586-0552-4 **	16	12.1	11.35	7.5	12.5	8.57
FH12A-18S-0.5SH(**)	586-0553-7 **	18	13.1	12.35	8.5	13.5	9.57
FH12A-20S-0.5SH(**)	586-0554-0 **	20	14.1	13.35	9.5	14.5	10.57
FH12A-22S-0.5SH(**)	586-0686-0 **	22	15.1	14.35	10.5	15.5	11.57
FH12A-24S-0.5SH(**)	586-0555-2 **	24	16.1	15.35	11.5	16.5	12.57
FH12A-26S-0.5SH(**)	586-0663-5 **	26	17.1	16.35	12.5	17.5	13.57
FH12A-28S-0.5SH(**)	586-0725-0 **	28	18.1	17.35	13.5	18.5	14.57
FH12A-29S-0.5SH(**)	586-0585-3 **	29	18.6	17.85	14.0	19.0	15.07
FH12A-30S-0.5SH(**)	586-0556-5 **	30	19.1	18.35	14.5	19.5	15.57
FH12A-32S-0.5SH(**)	586-0687-3 **	32	20.1	19.35	15.5	20.5	16.57
FH12A-33S-0.5SH(**)	586-0570-6 **	33	20.6	19.85	16.0	21.0	17.07
FH12A-34S-0.5SH(**)	586-0670-0 **	34	21.1	20.35	16.5	21.5	17.57
FH12A-36S-0.5SH(**)	586-0662-2 **	36	22.1	21.35	17.5	22.5	18.57
FH12A-40S-0.5SH(**)	586-0557-8 **	40	24.1	23.35	19.5	24.5	20.57
FH12A-42S-0.5SH(**)	586-0698-0 **	42	25.1	24.35	20.5	25.5	21.57
FH12A-45S-0.5SH(**)	586-0558-0 **	45	26.6	25.85	22.0	27.0	23.07
FH12A-50S-0.5SH(**)	586-0559-3 **	50	29.1	28.35	24.5	29.5	25.57

- Note 1 : Embossed tape reel packaging (2,000 pcs/reel).
Order by number of reels.

0.5mm Pitch Vertical mounting Type



Note 1 : The coplanarity of each terminal lead within specified dimension is 0.1mm Max.

Note 2 : Packaged on tape and reel only. Check packaging specification.

Note 3 : Slight variations in color of the plastic compounds do not affect form, fit or function of the connector.

Note 4 : After reflow, the terminal plating may change color, however this does not represent a quality issue.

Unit : mm

Part No.	HRS No.	No. of Contacts	A	B	C	D	E	F
FH12-6S-0.5SVA (54)	586-0756-4 54	6	6.4	4.9	2.5	4.5	6.2	4
FH12-10S-0.5SVA (54)	586-0806-0 54	10	8.4	6.9	4.5	6.5	8.2	4
FH12-12S-0.5SVA (54)	586-0757-7 54	12	9.4	7.9	5.5	7.5	9.2	4
FH12-13S-0.5SVA (54)	586-0807-3 54	13	9.9	8.4	6.0	8.0	9.7	4
FH12-15S-0.5SVA (54)	586-0808-6 54	15	10.9	9.4	7.0	9.0	10.7	4
FH12-16S-0.5SVA (54)	586-0809-9 54	16	11.4	9.9	7.5	9.5	11.2	4
FH12-17S-0.5SVA (54)	586-0810-8 54	17	11.9	10.4	8.0	10.0	11.7	4
FH12-18S-0.5SVA (54)	586-0811-0 54	18	12.4	10.9	8.5	10.5	12.2	4
FH12-20S-0.5SVA (54)	586-0812-3 54	20	13.4	11.9	9.5	11.5	13.2	4
FH12-22S-0.5SVA (54)	586-0813-6 54	22	14.4	12.9	10.5	12.5	14.2	8
FH12-24S-0.5SVA (54)	586-0814-9 54	24	15.4	13.9	11.5	13.5	15.2	8
FH12-26S-0.5SVA (54)	586-0815-1 54	26	16.4	14.9	12.5	14.5	16.2	8
FH12-30S-0.5SVA (54)	586-0750-8 54	30	18.4	16.9	14.5	16.5	18.2	8
FH12-32S-0.5SVA (54)	586-0816-4 54	32	19.4	17.9	15.5	17.5	19.2	8
FH12-33S-0.5SVA (54)	586-0818-0 54	33	19.9	18.4	16.0	18.0	19.7	8
FH12-34S-0.5SVA (54)	586-0817-7 54	34	20.4	18.9	16.5	18.5	20.2	8
FH12-36S-0.5SVA (54)	586-0819-2 54	36	21.4	19.9	17.5	19.5	21.2	8
FH12-40S-0.5SVA (54)	586-0804-5 54	40	23.4	21.9	19.5	21.5	23.2	8
FH12-45S-0.5SVA (54)	586-0820-1 54	45	25.9	24.4	22.0	24.0	25.7	8
FH12-49S-0.5SVA (54)	586-0821-4 54	49	27.9	26.4	24.0	26.0	27.7	8
FH12-50S-0.5SVA (54)	586-0805-8 54	50	28.4	26.9	24.5	26.5	28.2	8
FH12-60S-0.5SVA (54)	586-0749-9 54	60	33.4	31.9	29.5	31.5	33.2	8

Note 1 : Embossed tape reel packaging (1,000 pcs/reel, 500 pcs/reel).

Order by number of reels.

1mm Pitch Type Bottom Contact Type



Note 1 : The coplanarity of each terminal lead within specified dimension is 0.1mm Max.

Note 2 : Packaged on tape and reel only. Check packaging specification.

Note 3 : Slight variations in color of the plastic compounds do not affect form, fit or function of the connector.

Note 4 : After reflow, the terminal plating may change color, however this does not represent a quality issue.

Unit : mm

	Part No.	HRS No.	No. of Contacts	A	B	C	D	E
Standard type	FH12-5S-1SH(**)	586-0591-6 **	5	4	8.6	9.6	6.07	2.3
	FH12-6S-1SH(**)	586-0607-4 **	6	5	9.6	10.6	7.07	2.3
	FH12-7S-1SH(**)	586-0535-5 **	7	6	10.6	11.6	8.07	2.3
	FH12-8S-1SH(**)	586-0579-0 **	8	7	11.6	12.6	9.07	2.3
	FH12-9S-1SH(**)	586-0540-5 **	9	8	12.6	13.6	10.07	2.3
	FH12-11S-1SH(**)	586-0668-9 **	11	10	14.6	15.6	12.07	2.3
	FH12-12S-1SH(**)	586-0741-7 **	12	11	15.6	16.6	13.07	2.3
	FH12-16S-1SH(**)	586-0536-8 **	16	15	19.6	20.6	17.07	2.3
	FH12-17S-1SH(**)	586-0739-5 **	17	16	20.6	21.6	18.07	2.3
	FH12-22S-1SH(**)	586-0547-4 **	22	21	25.6	26.6	23.07	2.3
	FH12-26S-1SH(**)	586-0592-9 **	26	25	29.6	30.6	27.07	2.3
Eccentric type	FH12-10(4)SA-1SH(**)	586-0537-0 **	4	3	8.1	9.1	5.57	2.8
	FH12-14(6)SA-1SH(**)	586-0538-3 **	6	5	10.1	11.1	7.57	2.8
	FH12-18(8)SA-1SH(**)	586-0539-6 **	8	7	12.1	13.1	9.57	2.8
	FH12-22(10)SA-1SH(**)	586-0541-8 **	10	9	14.1	15.1	11.57	2.8
	FH12-24(11)SA-1SH(**)	586-0542-0 **	11	10	15.1	16.1	12.57	2.8
	FH12-30(14)SA-1SH(**)	586-0543-3 **	14	13	18.1	19.1	15.57	2.8
	FH12-40(19)SA-1SH(**)	586-0546-1 **	19	18	23.1	24.1	20.57	2.8
	FH12-50(24)SA-1SH(**)	586-0548-7 **	24	23	28.1	29.1	25.57	2.8

Note 1 : Embossed tape reel packaging (2,000 pcs/reel, 500 pcs/reel).
Order by number of reels.

1mm Pitch Vertical Mounting Type



Note 1 : The coplanarity of each terminal lead within specified dimension is 0.1mm Max.

Note 2 : Packaged on tape and reel only. Check packaging specification.

Note 3 : Slight variations in color of the plastic compounds do not affect form, fit or function of the connector.

Note 4 : After reflow, the terminal plating may change color, however this does not represent a quality issue.

Unit : mm

Part No.	HRS No.	No. of Contacts	A	B	C	D	E	F
FH12- 6S-1SVA (54)	586-0822-0 54	6	9.9	8.4	5	8	9.7	4
FH12- 7S-1SVA (54)	586-0823-0 54	7	10.9	9.4	6	9	10.7	4
FH12- 8S-1SVA (54)	586-0824-0 54	8	11.9	10.4	7	10	11.7	4
FH12-16S-1SVA (54)	586-0825-0 54	16	19.9	18.4	15	18	19.7	8
FH12-20S-1SVA (54)	586-0826-0 54	20	23.9	22.4	19	22	23.7	8
FH12-22S-1SVA (54)	586-0827-0 54	22	25.9	24.4	21	24	25.7	8
FH12-24S-1SVA (54)	586-0828-0 54	24	27.9	26.4	23	26	27.7	8

Note 1 : Embossed tape reel packaging (1,000 pcs/reel, 500 pcs/reel).

Order by number of reels.

Recommended FPC/FFC dimensions and Land/Metal Mask dimensions

0.5mm Pitch Product

	FPC/FFC dimensions	Land / Metal Mask dimensions																																																																																																																																																																																																										
0.5mm Pitch Bottom Contact Type 0.5mm Pitch Top Contact Type	<p>*Set the stiffener thickness to 0.188 (7.5mil) min.</p> <p style="text-align: center;">Unit : mm</p> <table border="1"> <thead> <tr> <th rowspan="2">Dimension Number of Contacts</th> <th colspan="2">A</th> <th colspan="2">B</th> </tr> <tr> <th>A</th> <th>B</th> <th>Number of Contacts</th> <th>Dimension</th> </tr> </thead> <tbody> <tr><td>6</td><td>2.5</td><td>3.5</td><td>25</td><td>12.0</td></tr> <tr><td>8</td><td>3.5</td><td>4.5</td><td>26</td><td>12.5</td></tr> <tr><td>10</td><td>4.5</td><td>5.5</td><td>28</td><td>13.5</td></tr> <tr><td>11</td><td>5.0</td><td>6.0</td><td>29</td><td>14.0</td></tr> <tr><td>12</td><td>5.5</td><td>6.5</td><td>30</td><td>14.5</td></tr> <tr><td>13</td><td>6.0</td><td>7.0</td><td>32</td><td>15.5</td></tr> <tr><td>14</td><td>6.5</td><td>7.5</td><td>33</td><td>16.0</td></tr> <tr><td>15</td><td>7.0</td><td>8.0</td><td>34</td><td>16.5</td></tr> <tr><td>16</td><td>7.5</td><td>8.5</td><td>35</td><td>17.0</td></tr> <tr><td>17</td><td>8.0</td><td>9.0</td><td>36</td><td>17.5</td></tr> <tr><td>18</td><td>8.5</td><td>9.5</td><td>40</td><td>19.5</td></tr> <tr><td>19</td><td>9.0</td><td>10.0</td><td>42</td><td>20.5</td></tr> <tr><td>20</td><td>9.5</td><td>10.5</td><td>45</td><td>22.0</td></tr> <tr><td>22</td><td>10.5</td><td>11.5</td><td>50</td><td>24.5</td></tr> <tr><td>24</td><td>11.5</td><td>12.5</td><td>53</td><td>26.0</td></tr> </tbody> </table>	Dimension Number of Contacts	A		B		A	B	Number of Contacts	Dimension	6	2.5	3.5	25	12.0	8	3.5	4.5	26	12.5	10	4.5	5.5	28	13.5	11	5.0	6.0	29	14.0	12	5.5	6.5	30	14.5	13	6.0	7.0	32	15.5	14	6.5	7.5	33	16.0	15	7.0	8.0	34	16.5	16	7.5	8.5	35	17.0	17	8.0	9.0	36	17.5	18	8.5	9.5	40	19.5	19	9.0	10.0	42	20.5	20	9.5	10.5	45	22.0	22	10.5	11.5	50	24.5	24	11.5	12.5	53	26.0	<p>Recommended metal mask thickness : 0.15mm</p> <p style="text-align: center;">Unit : mm</p> <table border="1"> <thead> <tr> <th rowspan="2">Dimension Number of Contacts</th> <th colspan="3">A</th> <th colspan="3">B</th> </tr> <tr> <th>A</th> <th>B</th> <th>C</th> <th>Number of Contacts</th> <th>A</th> <th>B</th> </tr> </thead> <tbody> <tr><td>6</td><td>2.5</td><td>8.1</td><td>4.5</td><td>25</td><td>12.0</td><td>17.6</td></tr> <tr><td>8</td><td>3.5</td><td>9.1</td><td>5.5</td><td>26</td><td>12.5</td><td>18.1</td></tr> <tr><td>10</td><td>4.5</td><td>10.1</td><td>6.5</td><td>28</td><td>13.5</td><td>19.1</td></tr> <tr><td>11</td><td>5.0</td><td>10.6</td><td>7.0</td><td>29</td><td>14.0</td><td>19.6</td></tr> <tr><td>12</td><td>5.5</td><td>11.1</td><td>7.5</td><td>30</td><td>14.5</td><td>20.1</td></tr> <tr><td>13</td><td>6.0</td><td>11.6</td><td>8.0</td><td>32</td><td>15.5</td><td>21.1</td></tr> <tr><td>14</td><td>6.5</td><td>12.1</td><td>8.5</td><td>33</td><td>16.0</td><td>21.6</td></tr> <tr><td>15</td><td>7.0</td><td>12.6</td><td>9.0</td><td>34</td><td>16.5</td><td>22.1</td></tr> <tr><td>16</td><td>7.5</td><td>13.1</td><td>9.5</td><td>35</td><td>17.0</td><td>22.6</td></tr> <tr><td>17</td><td>8.0</td><td>13.6</td><td>10.0</td><td>36</td><td>17.5</td><td>23.1</td></tr> <tr><td>18</td><td>8.5</td><td>14.1</td><td>10.5</td><td>40</td><td>19.5</td><td>25.1</td></tr> <tr><td>19</td><td>9.0</td><td>14.6</td><td>11.0</td><td>42</td><td>20.5</td><td>26.1</td></tr> <tr><td>20</td><td>9.5</td><td>15.1</td><td>11.5</td><td>45</td><td>22.0</td><td>27.6</td></tr> <tr><td>22</td><td>10.5</td><td>16.1</td><td>12.5</td><td>50</td><td>24.5</td><td>30.1</td></tr> <tr><td>24</td><td>11.5</td><td>17.1</td><td>13.5</td><td>53</td><td>26.0</td><td>31.6</td></tr> </tbody> </table>	Dimension Number of Contacts	A			B			A	B	C	Number of Contacts	A	B	6	2.5	8.1	4.5	25	12.0	17.6	8	3.5	9.1	5.5	26	12.5	18.1	10	4.5	10.1	6.5	28	13.5	19.1	11	5.0	10.6	7.0	29	14.0	19.6	12	5.5	11.1	7.5	30	14.5	20.1	13	6.0	11.6	8.0	32	15.5	21.1	14	6.5	12.1	8.5	33	16.0	21.6	15	7.0	12.6	9.0	34	16.5	22.1	16	7.5	13.1	9.5	35	17.0	22.6	17	8.0	13.6	10.0	36	17.5	23.1	18	8.5	14.1	10.5	40	19.5	25.1	19	9.0	14.6	11.0	42	20.5	26.1	20	9.5	15.1	11.5	45	22.0	27.6	22	10.5	16.1	12.5	50	24.5	30.1	24	11.5	17.1	13.5	53	26.0	31.6
	Dimension Number of Contacts		A		B																																																																																																																																																																																																							
A		B	Number of Contacts	Dimension																																																																																																																																																																																																								
6	2.5	3.5	25	12.0																																																																																																																																																																																																								
8	3.5	4.5	26	12.5																																																																																																																																																																																																								
10	4.5	5.5	28	13.5																																																																																																																																																																																																								
11	5.0	6.0	29	14.0																																																																																																																																																																																																								
12	5.5	6.5	30	14.5																																																																																																																																																																																																								
13	6.0	7.0	32	15.5																																																																																																																																																																																																								
14	6.5	7.5	33	16.0																																																																																																																																																																																																								
15	7.0	8.0	34	16.5																																																																																																																																																																																																								
16	7.5	8.5	35	17.0																																																																																																																																																																																																								
17	8.0	9.0	36	17.5																																																																																																																																																																																																								
18	8.5	9.5	40	19.5																																																																																																																																																																																																								
19	9.0	10.0	42	20.5																																																																																																																																																																																																								
20	9.5	10.5	45	22.0																																																																																																																																																																																																								
22	10.5	11.5	50	24.5																																																																																																																																																																																																								
24	11.5	12.5	53	26.0																																																																																																																																																																																																								
Dimension Number of Contacts	A			B																																																																																																																																																																																																								
	A	B	C	Number of Contacts	A	B																																																																																																																																																																																																						
6	2.5	8.1	4.5	25	12.0	17.6																																																																																																																																																																																																						
8	3.5	9.1	5.5	26	12.5	18.1																																																																																																																																																																																																						
10	4.5	10.1	6.5	28	13.5	19.1																																																																																																																																																																																																						
11	5.0	10.6	7.0	29	14.0	19.6																																																																																																																																																																																																						
12	5.5	11.1	7.5	30	14.5	20.1																																																																																																																																																																																																						
13	6.0	11.6	8.0	32	15.5	21.1																																																																																																																																																																																																						
14	6.5	12.1	8.5	33	16.0	21.6																																																																																																																																																																																																						
15	7.0	12.6	9.0	34	16.5	22.1																																																																																																																																																																																																						
16	7.5	13.1	9.5	35	17.0	22.6																																																																																																																																																																																																						
17	8.0	13.6	10.0	36	17.5	23.1																																																																																																																																																																																																						
18	8.5	14.1	10.5	40	19.5	25.1																																																																																																																																																																																																						
19	9.0	14.6	11.0	42	20.5	26.1																																																																																																																																																																																																						
20	9.5	15.1	11.5	45	22.0	27.6																																																																																																																																																																																																						
22	10.5	16.1	12.5	50	24.5	30.1																																																																																																																																																																																																						
24	11.5	17.1	13.5	53	26.0	31.6																																																																																																																																																																																																						
0.5mm Pitch Vertical Mounting Type	<p>*Set the stiffener thickness to 0.188 (7.5mil) min.</p> <p style="text-align: center;">Unit : mm</p> <table border="1"> <thead> <tr> <th rowspan="2">Dimension Number of Contacts</th> <th colspan="2">A</th> <th colspan="2">B</th> </tr> <tr> <th>A</th> <th>B</th> <th>Number of Contacts</th> <th>Dimension</th> </tr> </thead> <tbody> <tr><td>6</td><td>2.5</td><td>3.5</td><td>26</td><td>12.5</td></tr> <tr><td>10</td><td>4.5</td><td>5.5</td><td>30</td><td>14.5</td></tr> <tr><td>12</td><td>5.5</td><td>6.5</td><td>32</td><td>15.5</td></tr> <tr><td>13</td><td>6.0</td><td>7.0</td><td>33</td><td>16.0</td></tr> <tr><td>15</td><td>7.0</td><td>8.0</td><td>34</td><td>16.5</td></tr> <tr><td>16</td><td>7.5</td><td>8.5</td><td>36</td><td>17.5</td></tr> <tr><td>17</td><td>8.0</td><td>9.0</td><td>40</td><td>19.5</td></tr> <tr><td>18</td><td>8.5</td><td>9.5</td><td>45</td><td>22.0</td></tr> <tr><td>20</td><td>9.5</td><td>10.5</td><td>49</td><td>24.0</td></tr> <tr><td>22</td><td>10.5</td><td>11.5</td><td>50</td><td>24.5</td></tr> <tr><td>24</td><td>11.5</td><td>12.5</td><td>60</td><td>29.5</td></tr> </tbody> </table>	Dimension Number of Contacts	A		B		A	B	Number of Contacts	Dimension	6	2.5	3.5	26	12.5	10	4.5	5.5	30	14.5	12	5.5	6.5	32	15.5	13	6.0	7.0	33	16.0	15	7.0	8.0	34	16.5	16	7.5	8.5	36	17.5	17	8.0	9.0	40	19.5	18	8.5	9.5	45	22.0	20	9.5	10.5	49	24.0	22	10.5	11.5	50	24.5	24	11.5	12.5	60	29.5	<p>Recommended metal mask thickness : 0.15mm</p> <p style="text-align: center;">Unit : mm</p> <table border="1"> <thead> <tr> <th rowspan="2">Dimension Number of Contacts</th> <th colspan="2">A</th> <th colspan="2">B</th> </tr> <tr> <th>A</th> <th>B</th> <th>Number of Contacts</th> <th>Dimension</th> </tr> </thead> <tbody> <tr><td>10</td><td>6.5</td><td>4.5</td><td>26</td><td>14.5</td></tr> <tr><td>12</td><td>7.5</td><td>5.5</td><td>30</td><td>16.5</td></tr> <tr><td>13</td><td>8.0</td><td>6.0</td><td>32</td><td>17.5</td></tr> <tr><td>15</td><td>9.0</td><td>7.0</td><td>33</td><td>18.0</td></tr> <tr><td>16</td><td>9.5</td><td>7.5</td><td>34</td><td>18.5</td></tr> <tr><td>17</td><td>10.0</td><td>8.0</td><td>36</td><td>19.5</td></tr> <tr><td>18</td><td>10.5</td><td>8.5</td><td>40</td><td>21.5</td></tr> <tr><td>20</td><td>11.5</td><td>9.5</td><td>45</td><td>24.0</td></tr> <tr><td>22</td><td>12.5</td><td>10.5</td><td>49</td><td>26.0</td></tr> <tr><td>24</td><td>13.5</td><td>11.5</td><td>50</td><td>26.5</td></tr> <tr><td></td><td></td><td></td><td>60</td><td>31.5</td></tr> </tbody> </table>	Dimension Number of Contacts	A		B		A	B	Number of Contacts	Dimension	10	6.5	4.5	26	14.5	12	7.5	5.5	30	16.5	13	8.0	6.0	32	17.5	15	9.0	7.0	33	18.0	16	9.5	7.5	34	18.5	17	10.0	8.0	36	19.5	18	10.5	8.5	40	21.5	20	11.5	9.5	45	24.0	22	12.5	10.5	49	26.0	24	13.5	11.5	50	26.5				60	31.5																																																																										
	Dimension Number of Contacts		A		B																																																																																																																																																																																																							
A		B	Number of Contacts	Dimension																																																																																																																																																																																																								
6	2.5	3.5	26	12.5																																																																																																																																																																																																								
10	4.5	5.5	30	14.5																																																																																																																																																																																																								
12	5.5	6.5	32	15.5																																																																																																																																																																																																								
13	6.0	7.0	33	16.0																																																																																																																																																																																																								
15	7.0	8.0	34	16.5																																																																																																																																																																																																								
16	7.5	8.5	36	17.5																																																																																																																																																																																																								
17	8.0	9.0	40	19.5																																																																																																																																																																																																								
18	8.5	9.5	45	22.0																																																																																																																																																																																																								
20	9.5	10.5	49	24.0																																																																																																																																																																																																								
22	10.5	11.5	50	24.5																																																																																																																																																																																																								
24	11.5	12.5	60	29.5																																																																																																																																																																																																								
Dimension Number of Contacts	A		B																																																																																																																																																																																																									
	A	B	Number of Contacts	Dimension																																																																																																																																																																																																								
10	6.5	4.5	26	14.5																																																																																																																																																																																																								
12	7.5	5.5	30	16.5																																																																																																																																																																																																								
13	8.0	6.0	32	17.5																																																																																																																																																																																																								
15	9.0	7.0	33	18.0																																																																																																																																																																																																								
16	9.5	7.5	34	18.5																																																																																																																																																																																																								
17	10.0	8.0	36	19.5																																																																																																																																																																																																								
18	10.5	8.5	40	21.5																																																																																																																																																																																																								
20	11.5	9.5	45	24.0																																																																																																																																																																																																								
22	12.5	10.5	49	26.0																																																																																																																																																																																																								
24	13.5	11.5	50	26.5																																																																																																																																																																																																								
			60	31.5																																																																																																																																																																																																								

Jun. 1. 2024 Copyright 2024 HIROSE ELECTRIC CO., LTD. All Rights Reserved.

Recommended FPC/FFC dimensions and Land/Metal Mask dimensions

1mm Pitch Product

	FPC/FFC dimensions	Land / Metal Mask dimensions																																																																																																																																																																																																																																																			
1mm Pitch Bottom Contact Type	<p>※Set the stiffener thickness to 0.188 (7.5mil) min.</p> <p style="text-align: right;">Unit : mm</p> <table border="1"> <thead> <tr> <th rowspan="2">Dimension Number of Contacts</th> <th colspan="3">Standard Type</th> <th colspan="3">Eccentric Type</th> </tr> <tr> <th>A</th> <th>B</th> <th>C</th> <th>A</th> <th>B</th> <th>C</th> </tr> </thead> <tbody> <tr><td>5</td><td>4</td><td>6</td><td>1</td><td>4</td><td>3</td><td>5.5</td><td>1.5</td></tr> <tr><td>6</td><td>5</td><td>7</td><td>1</td><td>6</td><td>5</td><td>7.5</td><td>1.5</td></tr> <tr><td>7</td><td>6</td><td>8</td><td>1</td><td>8</td><td>7</td><td>9.5</td><td>1.5</td></tr> <tr><td>8</td><td>7</td><td>9</td><td>1</td><td>10</td><td>9</td><td>11.5</td><td>1.5</td></tr> <tr><td>9</td><td>8</td><td>10</td><td>1</td><td>11</td><td>10</td><td>12.5</td><td>1.5</td></tr> <tr><td>11</td><td>10</td><td>12</td><td>1</td><td>14</td><td>13</td><td>15.5</td><td>1.5</td></tr> <tr><td>12</td><td>11</td><td>13</td><td>1</td><td>19</td><td>18</td><td>20.5</td><td>1.5</td></tr> <tr><td>16</td><td>15</td><td>17</td><td>1</td><td>24</td><td>23</td><td>25.5</td><td>1.5</td></tr> <tr><td>17</td><td>16</td><td>18</td><td>1</td><td></td><td></td><td></td><td></td></tr> <tr><td>22</td><td>21</td><td>23</td><td>1</td><td></td><td></td><td></td><td></td></tr> <tr><td>26</td><td>25</td><td>27</td><td>1</td><td></td><td></td><td></td><td></td></tr> </tbody> </table>	Dimension Number of Contacts	Standard Type			Eccentric Type			A	B	C	A	B	C	5	4	6	1	4	3	5.5	1.5	6	5	7	1	6	5	7.5	1.5	7	6	8	1	8	7	9.5	1.5	8	7	9	1	10	9	11.5	1.5	9	8	10	1	11	10	12.5	1.5	11	10	12	1	14	13	15.5	1.5	12	11	13	1	19	18	20.5	1.5	16	15	17	1	24	23	25.5	1.5	17	16	18	1					22	21	23	1					26	25	27	1					<p>Recommended metal mask thickness : 0.15mm</p> <p style="text-align: right;">Unit : mm</p> <table border="1"> <thead> <tr> <th rowspan="2">Dimension Number of Contacts</th> <th colspan="5">Standard Type</th> <th colspan="5">Eccentric Type</th> </tr> <tr> <th>A</th> <th>B</th> <th>C</th> <th>D</th> <th></th> <th>A</th> <th>B</th> <th>C</th> <th>D</th> <th></th> </tr> </thead> <tbody> <tr><td>5</td><td>4</td><td>10.6</td><td>7</td><td>1.5</td><td></td><td>4</td><td>3</td><td>10.1</td><td>6.5</td><td>2</td></tr> <tr><td>6</td><td>5</td><td>11.6</td><td>8</td><td>1.5</td><td></td><td>6</td><td>5</td><td>12.1</td><td>8.5</td><td>2</td></tr> <tr><td>7</td><td>6</td><td>12.6</td><td>9</td><td>1.5</td><td></td><td>8</td><td>7</td><td>14.1</td><td>10.5</td><td>2</td></tr> <tr><td>8</td><td>7</td><td>13.6</td><td>10</td><td>1.5</td><td></td><td>10</td><td>9</td><td>16.1</td><td>12.5</td><td>2</td></tr> <tr><td>9</td><td>8</td><td>14.6</td><td>11</td><td>1.5</td><td></td><td>11</td><td>10</td><td>17.1</td><td>13.5</td><td>2</td></tr> <tr><td>11</td><td>10</td><td>16.6</td><td>13</td><td>1.5</td><td></td><td>14</td><td>13</td><td>20.1</td><td>16.5</td><td>2</td></tr> <tr><td>12</td><td>11</td><td>17.6</td><td>14</td><td>1.5</td><td></td><td>19</td><td>18</td><td>25.1</td><td>21.5</td><td>2</td></tr> <tr><td>16</td><td>15</td><td>21.6</td><td>18</td><td>1.5</td><td></td><td>24</td><td>23</td><td>30.1</td><td>26.5</td><td>2</td></tr> <tr><td>17</td><td>16</td><td>22.6</td><td>19</td><td>1.5</td><td></td><td></td><td></td><td></td><td></td><td></td></tr> <tr><td>22</td><td>21</td><td>27.6</td><td>24</td><td>1.5</td><td></td><td></td><td></td><td></td><td></td><td></td></tr> <tr><td>26</td><td>25</td><td>31.6</td><td>28</td><td>1.5</td><td></td><td></td><td></td><td></td><td></td><td></td></tr> </tbody> </table>	Dimension Number of Contacts	Standard Type					Eccentric Type					A	B	C	D		A	B	C	D		5	4	10.6	7	1.5		4	3	10.1	6.5	2	6	5	11.6	8	1.5		6	5	12.1	8.5	2	7	6	12.6	9	1.5		8	7	14.1	10.5	2	8	7	13.6	10	1.5		10	9	16.1	12.5	2	9	8	14.6	11	1.5		11	10	17.1	13.5	2	11	10	16.6	13	1.5		14	13	20.1	16.5	2	12	11	17.6	14	1.5		19	18	25.1	21.5	2	16	15	21.6	18	1.5		24	23	30.1	26.5	2	17	16	22.6	19	1.5							22	21	27.6	24	1.5							26	25	31.6	28	1.5						
	Dimension Number of Contacts		Standard Type			Eccentric Type																																																																																																																																																																																																																																															
A		B	C	A	B	C																																																																																																																																																																																																																																															
5	4	6	1	4	3	5.5	1.5																																																																																																																																																																																																																																														
6	5	7	1	6	5	7.5	1.5																																																																																																																																																																																																																																														
7	6	8	1	8	7	9.5	1.5																																																																																																																																																																																																																																														
8	7	9	1	10	9	11.5	1.5																																																																																																																																																																																																																																														
9	8	10	1	11	10	12.5	1.5																																																																																																																																																																																																																																														
11	10	12	1	14	13	15.5	1.5																																																																																																																																																																																																																																														
12	11	13	1	19	18	20.5	1.5																																																																																																																																																																																																																																														
16	15	17	1	24	23	25.5	1.5																																																																																																																																																																																																																																														
17	16	18	1																																																																																																																																																																																																																																																		
22	21	23	1																																																																																																																																																																																																																																																		
26	25	27	1																																																																																																																																																																																																																																																		
Dimension Number of Contacts	Standard Type					Eccentric Type																																																																																																																																																																																																																																															
	A	B	C	D		A	B	C	D																																																																																																																																																																																																																																												
5	4	10.6	7	1.5		4	3	10.1	6.5	2																																																																																																																																																																																																																																											
6	5	11.6	8	1.5		6	5	12.1	8.5	2																																																																																																																																																																																																																																											
7	6	12.6	9	1.5		8	7	14.1	10.5	2																																																																																																																																																																																																																																											
8	7	13.6	10	1.5		10	9	16.1	12.5	2																																																																																																																																																																																																																																											
9	8	14.6	11	1.5		11	10	17.1	13.5	2																																																																																																																																																																																																																																											
11	10	16.6	13	1.5		14	13	20.1	16.5	2																																																																																																																																																																																																																																											
12	11	17.6	14	1.5		19	18	25.1	21.5	2																																																																																																																																																																																																																																											
16	15	21.6	18	1.5		24	23	30.1	26.5	2																																																																																																																																																																																																																																											
17	16	22.6	19	1.5																																																																																																																																																																																																																																																	
22	21	27.6	24	1.5																																																																																																																																																																																																																																																	
26	25	31.6	28	1.5																																																																																																																																																																																																																																																	
1mm Pitch Vertical Mounting Type	<p>※Set the stiffener thickness to 0.188 (7.5mil) min.</p> <p style="text-align: right;">Unit : mm</p> <table border="1"> <thead> <tr> <th rowspan="2">Dimension Number of Contacts</th> <th colspan="2">Standard Type</th> </tr> <tr> <th>A</th> <th>B</th> </tr> </thead> <tbody> <tr><td>6</td><td>5</td><td>7</td></tr> <tr><td>7</td><td>6</td><td>8</td></tr> <tr><td>8</td><td>7</td><td>9</td></tr> <tr><td>16</td><td>15</td><td>17</td></tr> <tr><td>20</td><td>19</td><td>21</td></tr> <tr><td>22</td><td>21</td><td>23</td></tr> <tr><td>24</td><td>23</td><td>25</td></tr> </tbody> </table>	Dimension Number of Contacts	Standard Type		A	B	6	5	7	7	6	8	8	7	9	16	15	17	20	19	21	22	21	23	24	23	25	<p>Recommended metal mask thickness : 0.15mm</p> <p style="text-align: right;">Unit : mm</p> <table border="1"> <thead> <tr> <th rowspan="2">Dimension Number of Contacts</th> <th colspan="2">Standard Type</th> </tr> <tr> <th>A</th> <th>B</th> </tr> </thead> <tbody> <tr><td>6</td><td>8</td><td>5</td></tr> <tr><td>7</td><td>9</td><td>6</td></tr> <tr><td>8</td><td>10</td><td>7</td></tr> <tr><td>16</td><td>18</td><td>15</td></tr> <tr><td>20</td><td>22</td><td>19</td></tr> <tr><td>22</td><td>24</td><td>21</td></tr> <tr><td>24</td><td>26</td><td>23</td></tr> </tbody> </table>	Dimension Number of Contacts	Standard Type		A	B	6	8	5	7	9	6	8	10	7	16	18	15	20	22	19	22	24	21	24	26	23																																																																																																																																																																																															
	Dimension Number of Contacts		Standard Type																																																																																																																																																																																																																																																		
A		B																																																																																																																																																																																																																																																			
6	5	7																																																																																																																																																																																																																																																			
7	6	8																																																																																																																																																																																																																																																			
8	7	9																																																																																																																																																																																																																																																			
16	15	17																																																																																																																																																																																																																																																			
20	19	21																																																																																																																																																																																																																																																			
22	21	23																																																																																																																																																																																																																																																			
24	23	25																																																																																																																																																																																																																																																			
Dimension Number of Contacts	Standard Type																																																																																																																																																																																																																																																				
	A	B																																																																																																																																																																																																																																																			
6	8	5																																																																																																																																																																																																																																																			
7	9	6																																																																																																																																																																																																																																																			
8	10	7																																																																																																																																																																																																																																																			
16	18	15																																																																																																																																																																																																																																																			
20	22	19																																																																																																																																																																																																																																																			
22	24	21																																																																																																																																																																																																																																																			
24	26	23																																																																																																																																																																																																																																																			

Jun.1.2024 Copyright 2024 HIROSE ELECTRIC CO., LTD. All Rights Reserved.

◆ Packaging Specification

Embossed Carrier Tape Dimensions

Horizontal Type (Common to Bottom/Top Contact, 0.5mm/1mm Pitch)



Reel Dimensions (Common to All Types)



● 0.5mm Pitch Bottom/Top Contact Type

Unit : mm

Dimension Number of Contacts	A	B	C	D	E
6	16	—	7.5	17.4	21.4
8	16	—	7.5	17.4	21.4
10	16	—	7.5	17.4	21.4
11	16	—	7.5	17.4	21.4
12	24	—	11.5	25.4	29.4
13	24	—	11.5	25.4	29.4
14	24	—	11.5	25.4	29.4
15	24	—	11.5	25.4	29.4
16	24	—	11.5	25.4	29.4
17	24	—	11.5	25.4	29.4
18	24	—	11.5	25.4	29.4
19	24	—	11.5	25.4	29.4
20	24	—	11.5	25.4	29.4
22	24	—	11.5	25.4	29.4
24	24	—	11.5	25.4	29.4

Dimension Number of Contacts	A	B	C	D	E
25	24	—	11.5	25.4	29.4
26	24	—	11.5	25.4	29.4
28	32	28.4	14.2	33.4	37.4
29	32	28.4	14.2	33.4	37.4
30	32	28.4	14.2	33.4	37.4
32	32	28.4	14.2	33.4	37.4
33	32	28.4	14.2	33.4	37.4
34	32	28.4	14.2	33.4	37.4
35	44	40.4	20.2	45.4	49.4
36	44	40.4	20.2	45.4	49.4
40	44	40.4	20.2	45.4	49.4
42	44	40.4	20.2	45.4	49.4
45	44	40.4	20.2	45.4	49.4
50	44	40.4	20.2	45.4	49.4
53	44	40.4	20.2	45.4	49.4

● 1mm Pitch Bottom Contact Type

Unit : mm

Dimension Number of Contacts	A	B	C	D	E
5	16	—	7.5	17.4	21.4
6	24	—	11.5	25.4	29.4
7	24	—	11.5	25.4	29.4
8	24	—	11.5	25.4	29.4
9	24	—	11.5	25.4	29.4
11	24	—	11.5	25.4	29.4
12	24	—	11.5	25.4	29.4
16	32	28.4	14.2	33.4	37.4
17	44	40.4	20.2	45.4	49.4
22	44	40.4	20.2	45.4	49.4
26	44	40.4	20.2	45.4	49.4

Dimension Number of Contacts	A	B	C	D	E
4	16	—	7.5	17.4	21.4
6	24	—	11.5	25.4	29.4
8	24	—	11.5	25.4	29.4
10	24	—	11.5	25.4	29.4
11	24	—	11.5	25.4	29.4
14	32	28.4	14.2	33.4	37.4
19	44	40.4	20.2	45.4	49.4
24	44	40.4	20.2	45.4	49.4

Vertical Mounting Type (Common to 0.5mm/1mm Pitch)

Tape width 24mm max.



Tape width 32mm min.



Reel Dimensions (Common to All Types)



●0.5mm Pitch Vertical mounting Type

Unit : mm

Dimension Number of Contacts	A	B	C	D	E
6	16	—	7.5	17.4	21.4
10	16	—	7.5	17.4	21.4
12	16	—	7.5	17.4	21.4
13	24	—	11.5	25.4	29.4
15	24	—	11.5	25.4	29.4
16	24	—	11.5	25.4	29.4
17	24	—	11.5	25.4	29.4
18	24	—	11.5	25.4	29.4
20	24	—	11.5	25.4	29.4
22	24	—	11.5	25.4	29.4
24	24	—	11.5	25.4	29.4

Dimension Number of Contacts	A	B	C	D	E
26	24	—	11.5	25.4	29.4
30	32	28.4	14.2	33.4	37.4
32	32	28.4	14.2	33.4	37.4
33	32	28.4	14.2	33.4	37.4
34	44	40.4	20.2	45.4	49.4
36	44	40.4	20.2	45.4	49.4
40	44	40.4	20.2	45.4	49.4
45	44	40.4	20.2	45.4	49.4
49	44	40.4	20.2	45.4	49.4
50	44	40.4	20.2	45.4	49.4
60	56	52.4	26.2	57.4	61.4

●1mm Pitch Vertical mounting Type Unit : mm

Dimension Number of Contacts	A	B	C	D	E
6	24	—	11.5	25.4	29.4
7	24	—	11.5	25.4	29.4
8	24	—	11.5	25.4	29.4
16	32	28.4	14.2	33.4	37.4
20	44	40.4	20.2	45.4	49.4
22	44	40.4	20.2	45.4	49.4
24	44	40.4	20.2	45.4	49.4

Jun. 1. 2024 Copyright 2024 HIROSE ELECTRIC CO., LTD. All Rights Reserved.

FH12 Series FPC/FFC Construction (Recommended Specifications)

1. FFC

FFC : Flexible Flat Cable



Material Name	Material	Thickness (μm)
Polyester film		(12)
Adhesive	Thermoplastic polyester	(30)
(Nickel under plated / Gold plated), soft copper film		35
Adhesive	Polyester type	30
Polyester		12
Adhesive	Polyester type	30
Stiffener	Polyester type	188 (Note)
Total		295

*Real tolerance of thickness dimension is on the order of ±20μm (275 to 315μm)

Note : Use of a thicker FFC results in a stiffer lock action and the lock is more easily released.

A factor that contributes to thicker FFC is the use of 250μm stiffener which is thicker than the standard (188μm) product. This results in a total thickness of 357μm.

When using FFC, control of FFC thickness becomes easy if you indicate to us the thickness of the stiffener.

2. FPC

FPC : Flexible Printed Circuit



Material Name	Material	Thickness (μm)
Covering layer film	Polyimide 1 mil	(25)
Cover adhesive		(25)
Surface treatment	Nickel under plated 1to 5μm / Gold plated 0.2μm	3
Copper foil	Cu 1oz	35
Base adhesive	Heat-hardened adhesive	25
Base film	Polyimide 1 mil	25
Reinforcement material adhesive	Heat-hardened adhesive	30
Stiffener	Polyimide 7 mil	175
Total		293

3. Precautions

1. This specification is a recommendation for the construction of the FH12 Series FPC and FFC (t=0.3±0.05).
2. For details about the construction, please contact the FPC/FFC manufacturers.

Recommended Temperature Profile



HRS test conditions

- Solder method : Reflow, IR/hot air
- Environment : Room air
- Solder composition : Paste, 96.5%Sn/3%Ag/0.5%Cu (Senju Metal Industry, Co., Ltd.'s Part Number: M705-221CM5-32-10.5)
- Test board : Glass epoxy 40mm×80mm×1.6mm thick
- Land dimensions : Top and bottom contact type 0.3mm×1.3mm Vertical mounting type 0.6mm×1.5mm
- Metal mask : Top and bottom contact type 0.25mm×1.3mm×0.15mm thick Vertical mounting type 0.5mm×1.5mm×0.15mm thick

This temperature profile is based on the above conditions. In individual applications the actual temperature may vary, depending on solder paste type, volume/thickness and board size/thickness. Consult your solder paste and equipment manufacturer for specific recommendations.

◆ Connector Operating Instructions, precautions and recommendations
● Bottom Contact Type (common for 0.5mm/1mm Pitch)

Operation	Precautions
<p>1. FPC/FFC Termination procedure. Connector installed on the board.</p> <p>1) Lift up the actuator. Use thumb or index finger.</p>  <p>2) Fully insert the FPC/FFC parallel to mounting surface, with the exposed conductive traces facing down.</p> 	<p>1) Avoid grasping the actuator with two fingers or lifting the actuator with fingernail.</p>  <p>2) Do not use a thin tool such as the tip of a screwdriver to release the lock lever. Doing so will cause deformation of the contacts.</p>  <p>3) Do not apply force in the direction of arrows A, B, or C while the lock lever is open. Doing so will cause the lock lever to become disengaged, or will damage the hook portion of the connector body.</p>  <p>4) When inserting the FPC/FFC, do not forcefully rub against the surface beneath the connector insertion slot. Doing so will result in the FPC/FFC forcefully striking the contacts and this will cause contact deformation, peeling of the FPC/FFC conductors, and other irregularities.</p>  <p>5) Insert the FPC/FFC at the proper position of the connector insertion slot, and insert perpendicularly with respect to the connector. Improper insertion will cause continuity problems, disengagement of the lock lever, and damage to the hook portion.</p> 

Jun. 1. 2024 Copyright 2024 HIROSE ELECTRIC CO., LTD. All Rights Reserved.

● Bottom Contact Type (common for 0.5mm/1mm Pitch)

Operation	Precautions
<p>3) Rotate down the actuator until firmly closed. It is critical that the inserted FPC/FFC is not moved and remains fully inserted. Should the FPC/FFC be moved, open the actuator and repeat the process, starting with Step 1.</p>  <p>2. FPC/FFC Removal</p> <p>1) Lift up the actuator. 2) Carefully remove the FPC/FFC.</p> 	<p>6) Partial insertion of the FPC/FFC, offset insertion, and diagonal insertion will result in an unfavorable engagement of the lock lever in which the lock lever is raised. To correct this, first remove the FPC/FFC and then reinsert it. Forcing the lock will damage the connector.</p>  <p>7) When locking, handle the FPC/FFC so that a load is not applied to the FPC/FFC as would occur by pulling the FPC/FFC, or lifting it, etc. When a load is applied in the opposite direction to the rotational movement of the lock, an excessive load will be applied and this will cause connector damage.</p>  <p>8) At the time of lock operation, application of force such as that indicated by the arrows in the diagrams below will cause the lock lever to disengage. When the lock lever has become disengaged, please exchange the entire connector.</p> 

Jun.1.2024 Copyright 2024 HIROSE ELECTRIC CO., LTD. All Rights Reserved.

●Top Contact Type

Operation	Precautions
<p>1. FPC/FFC Termination procedure. Connector installed on the board.</p> <p>1) Lift up the actuator. Use thumb or index finger.</p>  <p>2) Fully insert the FPC/FFC parallel to mounting surface, with the exposed conductive traces facing UP.</p>  <p>3) Rotate down the actuator until firmly closed. It is critical that the inserted FPC/FFC is not moved and remains fully inserted. Should the FPC/FFC be moved, open the actuator and repeat the process, starting with Step 1 above.</p> 	<p>1) Avoid further lifting of the actuator once the lock has been released. Doing so will cause the lock lever to separate from the rotational shaft, and the lock lever will become disengaged or the hook portion of the connector body will be damaged.</p>  <p>2) Avoid further pressing of the lock portion from the locked condition when the FPC/FFC has not yet been inserted. Doing so will cause the lock lever to become disengaged from the rotational shaft, and the hook portion of the connector body will be damaged.</p>  <p>3) Do not insert the FPC/FFC diagonally. Doing so will result in the corners of the FPC/FFC catching on the contacts and will cause deformation of the contacts.</p> 
<p>2. FPC/FFC Removal</p> <p>1) Lift up the actuator.</p> <p>2) Carefully remove the FPC/FFC.</p> 	<p>4) When closing down the actuator apply equal pressure to both sides of the actuator.</p> 

●Vertical Mounting type (common for 0.5mm/1mm pitch)

Operation	Precautions
<p>1. FPC/FFC Termination procedure. Connector installed on the board.</p> <p>1) Verify that the actuator is positioned upright. If the actuator has rotated to the side, carefully rotate it upright. Actuator upright</p>  <p>2) Insert the FPC/FFC vertically in the connector slot assuring that the conductive traces of the FPC/FFC are facing away from the actuator.</p>  <p>3) Press down the actuator in the direction shown.</p> 	<p>1) Avoid forcing the actuator up or down without the FPC/FFC inserted.</p>  <p>2) Do not attempt to open or over rotate an already released actuator (refer to the diagram below). These actions may damage the actuator.</p>  <p>3) Do not insert the FPC/FFC diagonally. Doing so will result in the corners of the FPC/FFC catching on the contacts and will cause deformation of the contacts.</p> 
<p>2. FPC/FFC Removal</p> <p>Rotate the actuator upward and withdraw the FPC/FFC.</p> 	<p>4) Do not press down vertically on the actuator when the FPC/FFC already inserted, it needs to be rotated to engage the lock. Refer to the diagram below. Doing so may cause actuator failure.</p> 

Jun.1.2024 Copyright 2024 HIROSE ELECTRIC CO., LTD. All Rights Reserved.

USA:

HIROSE ELECTRIC (U.S.A.), INC. HEADQUARTERS CHICAGO OFFICE
2300 Warrenville Road, Suite 150,
Downers Grove, IL 60515
Phone : +1-630-282-6700
<http://www.hirose.com/us/>

USA:

HIROSE ELECTRIC (U.S.A.), INC. SAN JOSE OFFICE
2841 Junction Ave, Suite 200
San Jose, CA. 95134
Phone : +1-408-253-9640
Fax : +1-408-253-9641
<http://www.hirose.com/us/>

USA:

HIROSE ELECTRIC (U.S.A.), INC. DETROIT OFFICE (AUTOMOTIVE)
17197 N. Laurel Park Drive, Suite 253,
Livonia, MI 48152
Phone : +1-734-542-9963
Fax : +1-734-542-9964
<http://www.hirose.com/us/>

THE NETHERLANDS:

HIROSE ELECTRIC EUROPE B.V.
Hogehillweg #8 1101 CC Amsterdam Z-O
Phone : +31-20-6557460
Fax : +31-20-6557469
<http://www.hirose.com/eu/>

GERMANY:

HIROSE ELECTRIC EUROPE B.V. GERMAN BRANCH
Schoenbergstr. 20, 73760 ostfildern
Phone : +49-711-456002-1
Fax : +49-711-456002-299
<http://www.hirose.com/eu/>

GERMANY:

HIROSE ELECTRIC EUROPE B.V. NUREMBERG OFFICE
Neumeyerstrasse 22-26, 90411 Nurnberg
Phone : +49-911 32 68 89 63
Fax : +49-911 32 68 89 69
<http://www.hirose.com/eu/>

GERMANY:

HIROSE ELECTRIC EUROPE B.V. HANOVER OFFICE
Bayernstr. 3, Haus C 30855 Langenhagen, Germany
Phone : +49-511 97 82 61 30
Fax : +49-511 97 82 61 35
<http://www.hirose.com/eu/>

FRANCE:

HIROSE ELECTRIC EUROPE B.V. PARIS OFFICE
Regus La Garenne Colombes, Place de La Belgique,
71 Boulevard National La Garenne Colombes, 92250, France
Phone : +33 (0) 1 7082 3170
Fax : +33 (1) 7082 3101
<http://www.hirose.com/eu/>

UNITED KINGDOM:

HIROSE ELECTRIC EUROPE BV (UK BRANCH)
4 Newton Court, Kelvin Drive, Knowlhill,
Milton Keynes, MK5 8NH
Phone : +44-1908 202050
Fax : +44-1908 202058
<http://www.hirose.com/eu/>

CHINA:

HIROSE ELECTRIC (SHANGHAI) CO., LTD.
1601, Henderson Metropolitan, NO.300, East Nanjing
Road, Huangpu District, Shanghai, China 200001
Phone : +86-21-6391-3355
Fax : +86-21-6391-3335
<http://www.hirose.com/cn/>

CHINA:

HIROSE ELECTRIC (SHANGHAI) CO.,LTD. BEIJING BRANCH
A1001, Ocean International Center, Building 56# East 4th
Ring Middle Road, ChaoYang District, Beijing, 100025
Phone : +86-10-5165-9332
Fax : +86-10-5908-1381
<http://www.hirose.com/cn/>

CHINA:

HIROSE ELECTRIC TECHNOLOGIES (SHENZHEN) CO., LTD.
Room 09-13, 19/F, Office Tower Shun Hing Square, Di Wang Commercial Centre,
5002 Shen Nan Dong Road, Shenzhen City, Guangdong Province, 518008
Phone : +86-755-8207-0851
Fax : +86-755-8207-0873
<http://www.hirose.com/cn/>

HONG KONG:

HIROSE ELECTRIC HONGKONG TRADING CO., LTD.
Room 1001, West Wing, Tsim Sha Tsui Centre, 66
Mody Road, Tsim Sha Tsui East, Kowloon, Hong Kong
Phone : +852-2803-5338
Fax : +852-2591-6560
<http://www.hirose.com/hk/>

TAIWAN:

HIROSE ELECTRIC TAIWAN CO., LTD.
103 8F, No.87, Zhengzhou Rd., Taipei
Phone : +886-2-2555-7377
Fax : +886-2-2555-7350
<http://www.hirose.com/tw/>

KOREA:

HIROSE KOREA CO.,LTD.
250, Huimanggongwon-ro, Siheung-si,
Gyeonggi-do, Korea, 15083
Phone : +82-31-496-7000 or 7124
Fax : +82-31-496-7100
<http://www.hirose.co.kr/>

SINGAPORE:

HIROSE ELECTRIC SINGAPORE PTE. LTD.
10 Anson Road #26-16, International Plaza
079903, Singapore
Phone : +65-6324-6113
Fax : +65-6324-6123
<http://www.hirose.com/sg/>

INDIA:

HIROSE ELECTRIC SINGAPORE PTE. LTD. DELHI LIAISON OFFICE
Office NO.552, Regus-Green Boulevard, Level5, Tower C,
Sec62, Plot B-9A, Block B, Noida, 201301, Uttar Pradesh, India
Phone : +91-12-660-8018
Fax : +91-120-4804949
<http://www.hirose.com/sg/>

INDIA:

HIROSE ELECTRIC SINGAPORE PTE. LTD. BANGALORE LIAISON OFFICE
Unit No-403, 4th Floor, No-84, Barton Centre, Mahatma
Gandhi (MG) Road, Bangalore 560 001, Karnataka, India
Phone : +91-80-4120 1907
Fax : +91-80-4120 9908
<http://www.hirose.com/sg/>

MALAYSIA:

PENANG REPRESENTATIVE OFFICE
1-21-01, Suntech @ Penang Cybercity (1164), Lintang
Mayang Pasir 3,11950, Bayan Baru, Penang, Malaysia.
Phone : +604-619-2564
Fax : +604-619-2574
<http://www.hirose.com/sg/>

THAILAND:

BANGKOK OFFICE (REPRESENTATIVE OFFICE)
Unit 4703, 47th FL., 1 Empire Tower, South Sathorn
Road, Yannawa, Sathorn, Bangkok 10120 Thailand
Phone : +66-2-686-1255
Fax : +66-2-686-3433
<http://www.hirose.com/sg/>

**HIROSE ELECTRIC CO.,LTD.**

2-6-3, Nakagawa Chuoh, Tsuzuki-Ku, Yokohama-Shi 224-8540, JAPAN
TEL: +81-45-620-3526 Fax: +81-45-591-3726
<http://www.hirose.com>
<http://www.hirose-connectors.com>

Looking for pricing, stock, or lifecycle information?

Click below to explore more details on WIN SOURCE:

- [View FH12-10S-0.5SVA\(54\) on WIN SOURCE](#)
- [Hirose Electric Co Ltd Information](#)

Optimize Your Supply Chain with WIN SOURCE Solutions

- ✓ Global Sourcing Solution
- ✓ Obsolete Management
- ✓ Cost Control Management
- ✓ Shortage Management
- ✓ Alternative Solution
- ✓ Excess Inventory Management