



**THE DATASHEET OF  
F2255NLGK8**



## Voltage Variable RF Attenuator

1MHz to 3000MHz

### GENERAL DESCRIPTION

The F2255 is a low insertion loss **V**oltage **V**ariable RF **A**ttenuator (VVA) designed for a multitude of wireless and other RF applications. This device covers a broad frequency range from 1MHz to 3000MHz. In addition to providing low insertion loss, the F2255 provides excellent linearity performance over its entire voltage control and attenuation range.

The F2255 uses a single positive supply voltage of 3.15V to 5.25V. Other features include the  $V_{MODE}$  pin allowing either positive or negative voltage control slope vs attenuation and multi-directional operation meaning the RF input can be applied to either RF1 or RF2 pins. Control voltage ranges from 0V to 3.6V using either positive or negative control voltage slope.

### COMPETITIVE ADVANTAGE

The F2255 provides extremely low insertion loss and superb IP3, IP2, Return Loss and Slope Linearity across the control range. Comparing to competitive VVAs this device is better as follows:

- ✓ Operation down to 1MHz
- ✓ Insertion Loss @ 500MHz: 1.1dB
- ✓ Maximum Attenuation Slope: 33dB/Volt
- ✓ Minimum Output IP3: 35dBm
- ✓ Minimum Input IP2: 74dBm
- ✓ High Operating Temperature: +105°C

### APPLICATIONS

- Base Station 2G, 3G, 4G
- Portable Wireless
- Repeaters and E911 systems
- Digital Pre-Distortion
- Point to Point Infrastructure
- Public Safety Infrastructure
- Satellite Receivers and Modems
- WIMAX Receivers and Transmitters
- Military Radios covering HF, VHF, UHF
- RFID handheld and portable readers
- Cable Infrastructure
- Wireless LAN
- Test / ATE Equipment

### FEATURES

- Low Insertion Loss: 1.1dB @ 500MHz
- Typical / Min IIP3: 60dBm / 46dBm
- Typical / Min IIP2: 98dBm / 74dBm
- 33dB Attenuation Range
- Bi-directional RF ports
- +36dBm Input P1dB compression
- $V_{MODE}$  pin allows either positive or negative control response
- Linear-in-dB attenuation characteristic
- Supply voltage: 3.15V to 5.25V
- $V_{CTRL}$  range: 0V to 3.6V using 5V supply
- +105°C max operating temperature
- 3mm x 3mm, 16-pin QFN package

### DEVICE BLOCK DIAGRAM

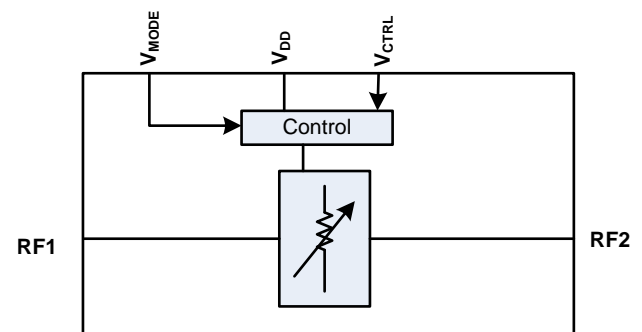

### ORDERING INFORMATION



### PART# MATRIX

Part#	RF Freq Range (MHz)	Insertion Loss (dB)	IIP3 (dBm)	Pinout Compatibility
F2250	50 - 6000	1.4 (at 2GHz)	+65	RFMD
F2255	1 - 3000	1.1 (at 500MHz)	+60	
F2258	50 - 6000	1.4 (at 2GHz)	+65	Hittite

## Voltage Variable RF Attenuator

1MHz to 3000MHz

### ABSOLUTE MAXIMUM RATINGS

Parameter / Condition	Symbol	Min	Max	Units
V <sub>DD</sub> to GND	V <sub>DD</sub>	-0.3	5.5	V
V <sub>MODE</sub> to GND	V <sub>MODE</sub>	-0.3	Minimum ( V <sub>DD</sub> , 3.9 )	V
V <sub>CTRL</sub> to GND	V <sub>CTRL</sub>	-0.3	Minimum ( V <sub>DD</sub> , 4.0 )	V
RF1, RF2 to GND	V <sub>RF</sub>	-0.3	0.3	V
RF1 or RF2 Input Power applied for 24 hours maximum (V <sub>DD</sub> applied @ 2GHz and T <sub>c</sub> =+85°C)	P <sub>MAX24</sub>		30	dBm
RF1 or RF2 Continuous Operating Power	P <sub>MAX_OP</sub>		See Figure 1	dBm
Maximum Junction Temperature	T <sub>JMAX</sub>		+150	°C
Storage Temperature Range	T <sub>ST</sub>	-65	+150	°C
Lead Temperature (soldering, 10s)	T <sub>LEAD</sub>		+260	°C
ESD Voltage– HBM (Per ESD STM5.1-2007)	V <sub>ESDHBM</sub>		Class 2	
ESD Voltage – CDM (Per ESD STM5.3.1-2009)	V <sub>ESDCDM</sub>		Class C3	

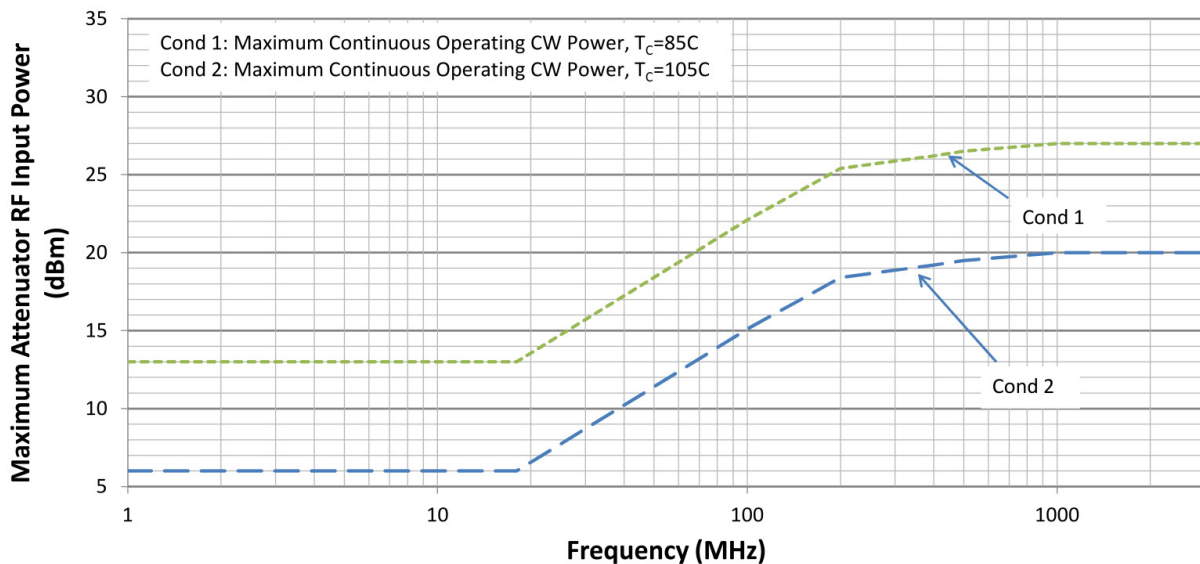

FIGURE 1: MAXIMUM OPERATING RF INPUT POWERS VS. RF FREQUENCY

Stresses above those listed above may cause permanent damage to the device. Functional operation of the device at these or any other conditions above those indicated in the operational section of this specification is not implied. Exposure to absolute maximum rating conditions for extended periods may affect device reliability.

### PACKAGE THERMAL AND MOISTURE CHARACTERISTICS

Θ <sub>JA</sub> (Junction – Ambient)	80.6°C/W
Θ <sub>Jc</sub> (Junction – Case) The Case is defined as the exposed paddle	5.1°C/W
Moisture Sensitivity Rating (Per J-STD-020)	MSL 1

**Voltage Variable RF Attenuator**
**1MHz to 3000MHz**
**F2255 OPERATING CONDITIONS**

Parameter	Symbol	Condition	Min	Typ	Max	Units
Operating Frequency Range	$F_{RF}$		1		3000	MHz
Supply Voltage	$V_{DD}$		3.15		5.25	V
$V_{MODE}$ Logic	$V_{IH}$	$V_{DD} > 3.9V$	1.17		3.6 <sup>2</sup>	V
		$V_{DD} = 3.15$ to 3.9V	1.17		$V_{DD} - 0.3V$	
	$V_{IL}$		0		0.63	
$V_{CTRL}$ Range	$V_{CTRL}$	$V_{DD} = 3.9V$ to 5.25V	0		3.6	V
		$V_{DD} = 3.15V$ to 3.9V	0		$V_{DD} - 0.3$	
Supply Current	$I_{DD}$		<b>0.50</b> <sup>1</sup>	1.15	<b>2</b>	mA
Logic Current	$I_{MODE}$		<b>-1.0</b>		<b>38</b>	$\mu A$
$I_{CTRL}$ Current	$I_{CTRL}$		<b>-1.0</b>		<b>14</b>	$\mu A$
RF Operating Power <sup>3</sup>	$P_{MAXCW}$				See Figure 1	dBm
RF1 Port Impedance	$Z_{RF1}$			50		$\Omega$
RF2 Port Impedance	$Z_{RF2}$			50		
Operating Temperature Range	$T_{CASE}$	Exposed Paddle Temperature	-40		+105	$^{\circ}C$

**Operating Conditions Notes:**

- 1 – Items in min/max columns in ***bold italics*** are Guaranteed by Test.
- 2 – Items in min/max columns that are not bold/italics are Guaranteed by Design Characterization.
- 3 – Refer to the Maximum **Operating** RF Input Power vs. RF Frequency curves in Figure 1.

**Voltage Variable RF Attenuator**
**1MHz to 3000MHz**
**F2255 SPECIFICATIONS**

Refer to EVKit / Applications Circuit,  $V_{DD} = +3.3V$ ,  $T_C = +25^\circ C$ , signals applied to RF1 input,  $F_{RF} = 500MHz$ , minimum attenuation,  $P_{IN} = 0dBm$  for small signal parameters,  $+20dBm$  for single tone linearity tests,  $+20dBm$  per tone for two tone tests, two tone delta frequency =  $80MHz$ , PCB board traces and connector losses are de-embedded unless otherwise noted. Refer to Typical Operating Curves for performance over entire frequency band.

Parameter	Symbol	Condition	Min	Typ	Max	Units
Insertion Loss, IL	$A_{MIN}$	Minimum Attenuation		1.1	<b><i>1.7</i></b> <sup>1</sup>	dB
Maximum attenuation	$A_{MAX}$		33	34.6		dB
Insertion Phase $\Delta$	$\Phi_{\Delta MAX}$	At 36dB attenuation relative to Insertion Loss		27		deg
	$\Phi_{\Delta MID}$	At 18dB attenuation relative to Insertion Loss		8		
Input 1dB Compression <sup>3</sup>	P1dB			36		dBm
Minimum RF1 Return Loss over control voltage range	S11	20MHz		23		dB
		500MHz		22		
		2000MHz		23		
		3000MHz		30		
Minimum RF2 Return Loss over control voltage range	S22	20MHz		23		dB
		500MHz		22		
		2000MHz		23		
		3000MHz		24		
Input IP3	IIP3			60		dBm
Input IP3 over Attenuation	IIP3 <sub>ATTEN</sub>	All attenuation settings	44 <sup>2</sup>	46		
Minimum Output IP3	OIP3 <sub>MIN</sub>	Maximum attenuation		35		
Input IP2	IIP2	$P_{IN} + IM2_{dBc}$ , IM2 term is $F1 + F2$		98		dBm
Minimum Input IP2	IIP2 <sub>MIN</sub>	All attenuation settings		74		dBm
Input IH2	HD2	$P_{IN} + H2_{dBc}$		82		dBm
Input IH3	HD3	$P_{IN} + (H3_{dBc}/2)$		49		dBm
Settling Time	$T_{SETTL0.1dB}$	Any 1dB step in the 0dB to 33dB control range 50% $V_{CTRL}$ to RF settled to within $\pm 0.1dB$		15		$\mu Sec$

**Specification Notes:**

- 1 – Items in min/max columns in ***bold italics*** are Guaranteed by Test.
- 2 – Items in min/max columns that are not bold/italics are Guaranteed by Design Characterization.
- 3 – The input 1dB compression point is a linearity figure of merit. Refer to Absolute Maximum Ratings section along with Figure 1 for the maximum RF input power vs. RF frequency.

**Voltage Variable RF Attenuator****1MHz to 3000MHz****TYPICAL OPERATING CURVES****UNLESS OTHERWISE NOTED, THE FOLLOWING CONDITIONS APPLY:**

- $V_{DD} = +3.3V$  or  $+5.0V$
- $T_C = +25^{\circ}C$
- $V_{MODE} = 0V$
- RF trace and connector losses are de-embedded for S-parameters
- $P_{in} = 0dBm$  for all small signal tests
- $P_{in} = +20dBm$  for single tone linearity tests (RF1 port driven)
- $P_{in} = +20dBm/tone$  for two tone linearity tests (RF1 port driven)
- Two tone frequency spacing = 80MHz

## Voltage Variable RF Attenuator

1MHz to 3000MHz

### TYPICAL OPERATING CONDITIONS [S2P BROADBAND PERFORMANCE] (-1-)

Attenuation vs.  $V_{CTRL}$

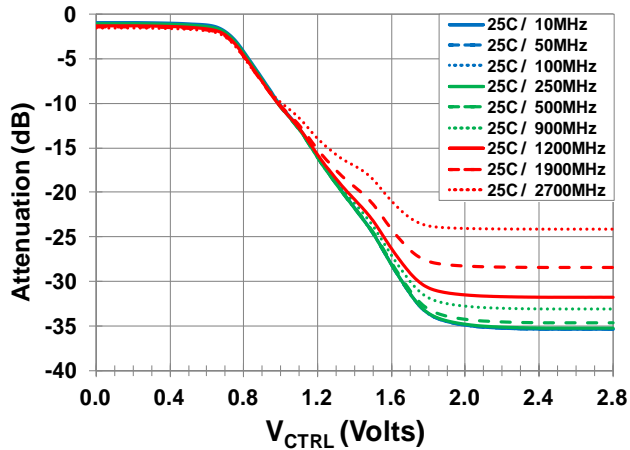

Attenuation vs. Frequency

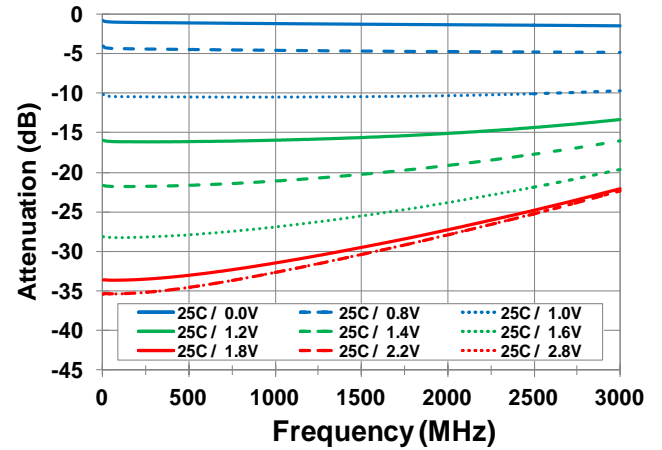

Attenuation Delta to 25C vs.  $V_{CTRL}$

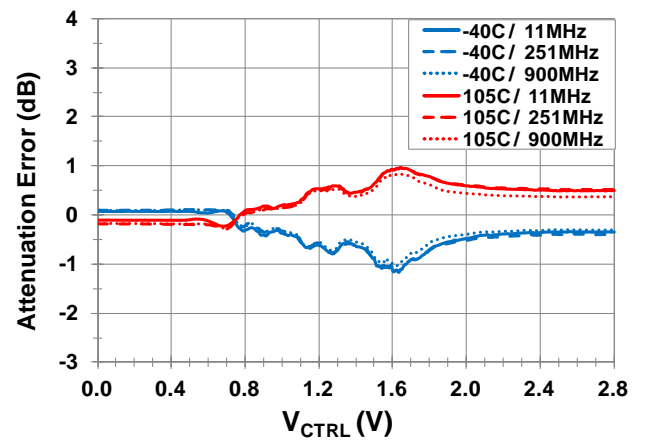

## Voltage Variable RF Attenuator

1MHz to 3000MHz

### TYPICAL OPERATING CURVES [S2P vs. $V_{CTRL}$ ] (-2-)

Attenuation vs.  $V_{CTRL}$

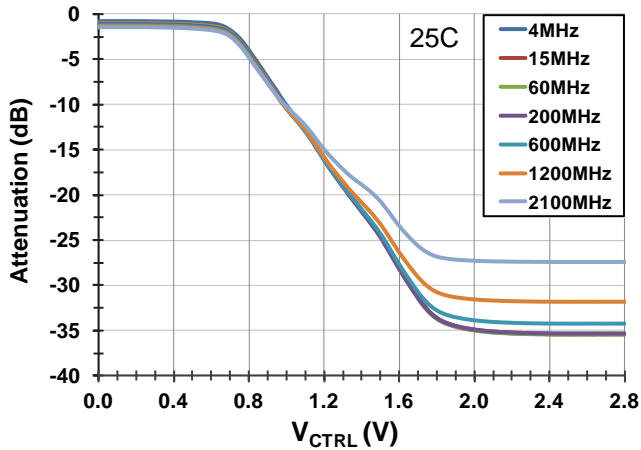

Attenuation Slope vs.  $V_{CTRL}$

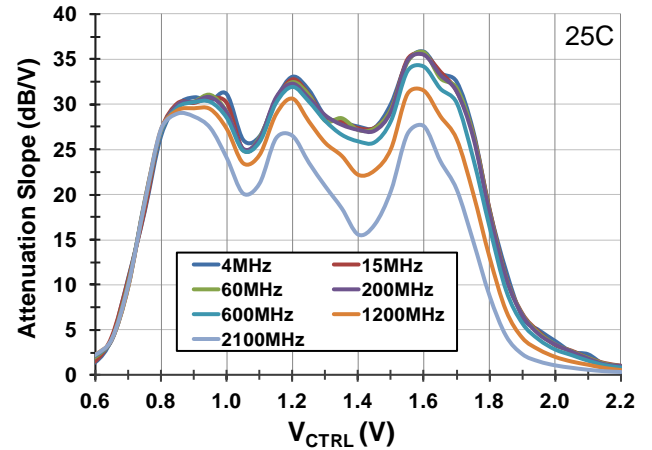

RF1 Return Loss vs.  $V_{CTRL}$

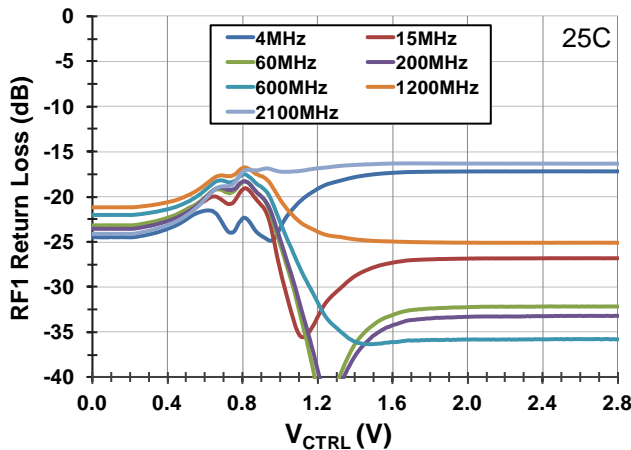

RF2 Return Loss vs.  $V_{CTRL}$

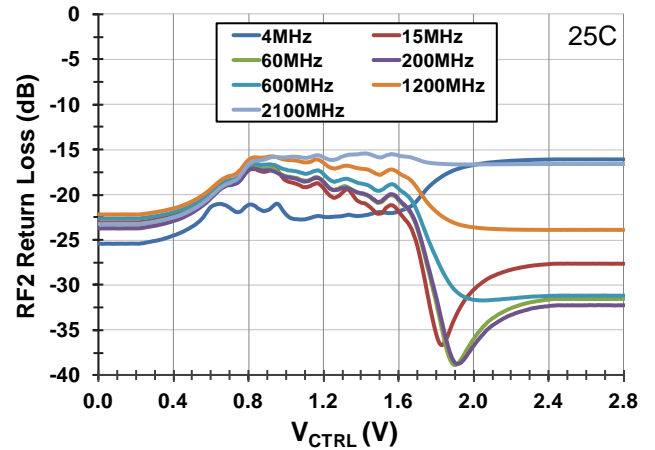

Insertion Phase  $\Delta$  vs.  $V_{CTRL}$

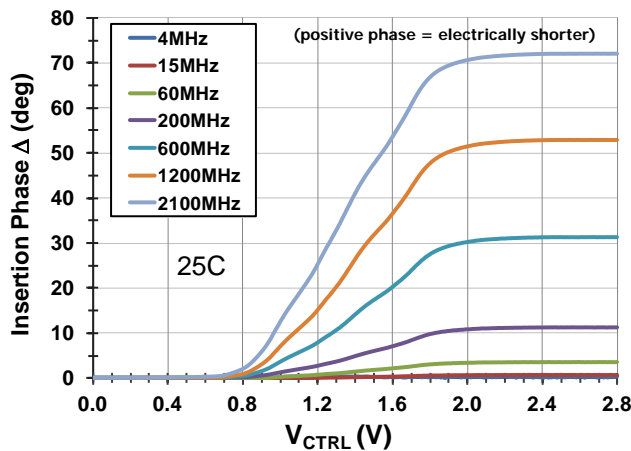

Insertion Phase Slope vs.  $V_{CTRL}$

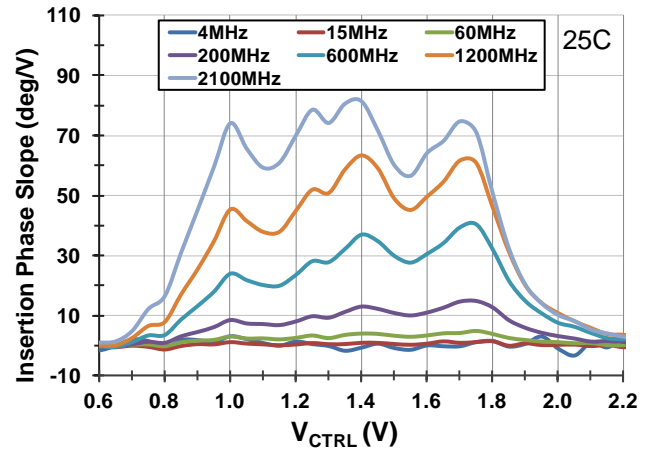

## Voltage Variable RF Attenuator

1MHz to 3000MHz

### TYPICAL OPERATING CONDITIONS [S2P vs. $V_{CTRL}$ & TEMPERATURE] (-3-)

Attenuation Response vs.  $V_{CTRL}$

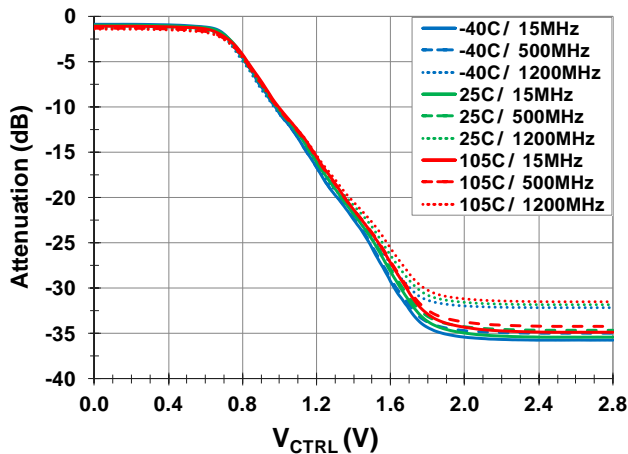

Attenuation Slope vs.  $V_{CTRL}$

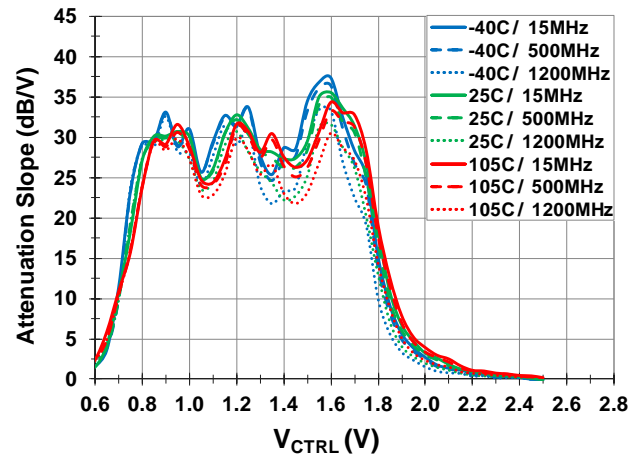

RF1 Return Loss vs.  $V_{CTRL}$

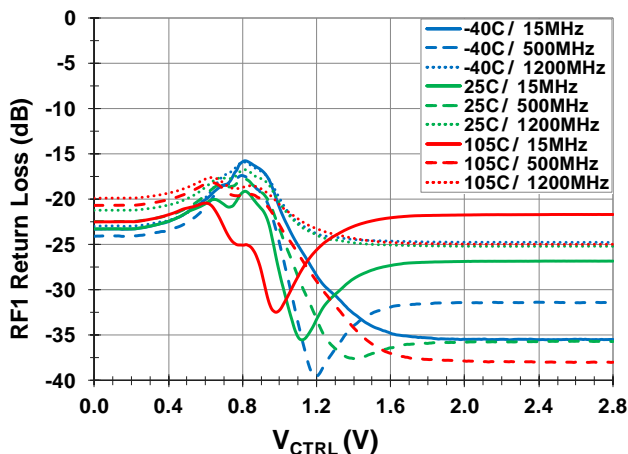

RF2 Return Loss vs.  $V_{CTRL}$

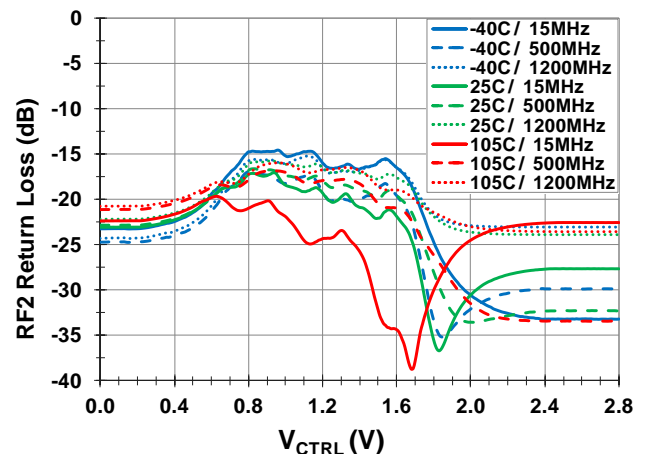

Insertion Phase  $\Delta$  vs.  $V_{CTRL}$

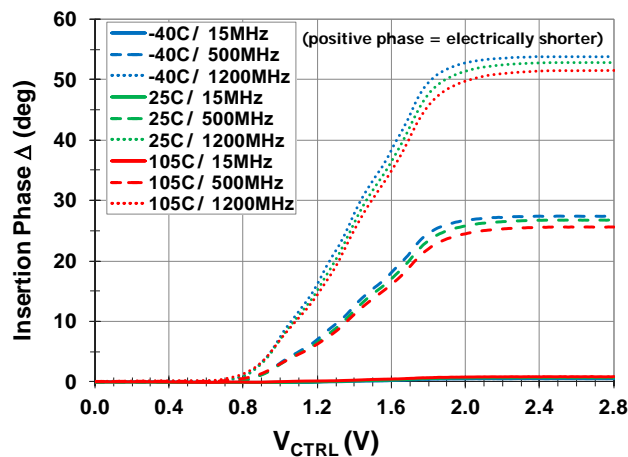

Insertion Phase Slope vs.  $V_{CTRL}$

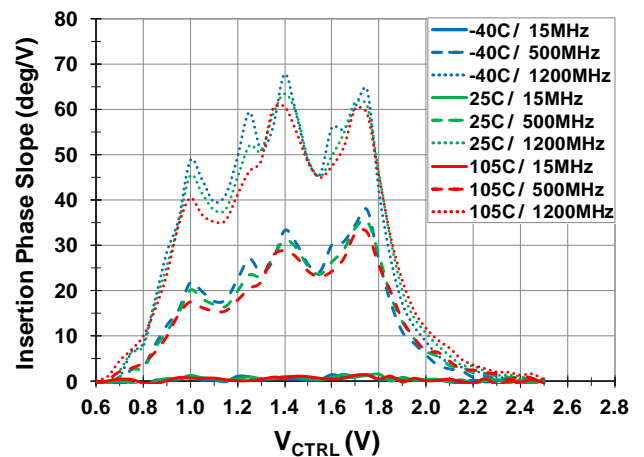

## Voltage Variable RF Attenuator

1MHz to 3000MHz

### TYPICAL OPERATING CONDITIONS [S2P vs. ATTENUATION & TEMPERATURE] (-4-)

RF1 Return Loss vs. Attenuation

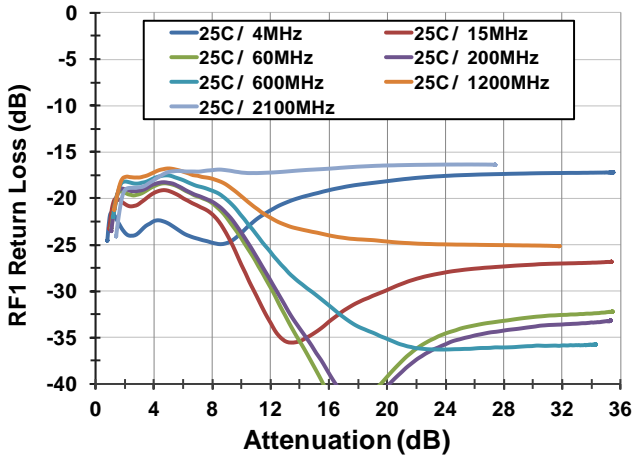

RF1 Return Loss vs. Attenuation

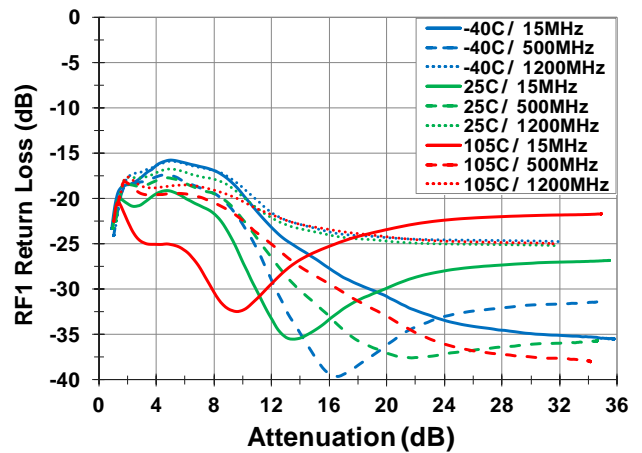

RF2 Return Loss vs. Attenuation

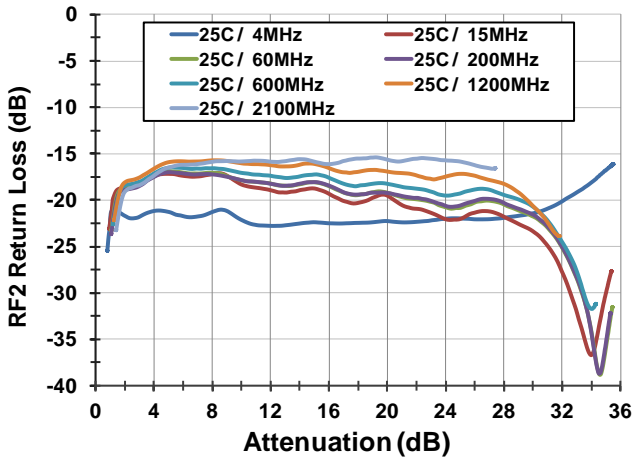

RF2 Return Loss vs. Attenuation

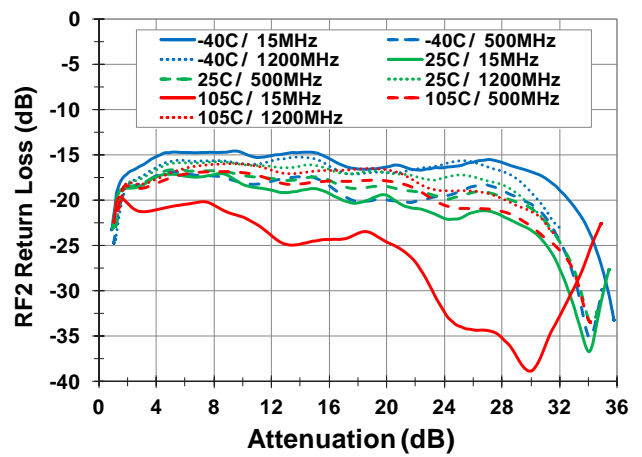

Insertion Phase  $\Delta$  vs. Attenuation

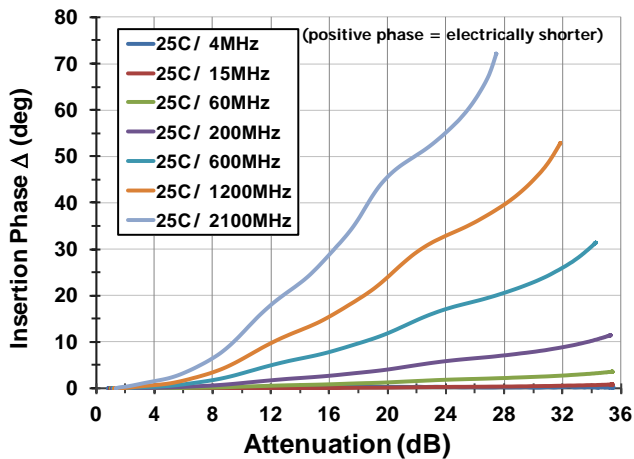

Insertion Phase  $\Delta$  vs. Attenuation

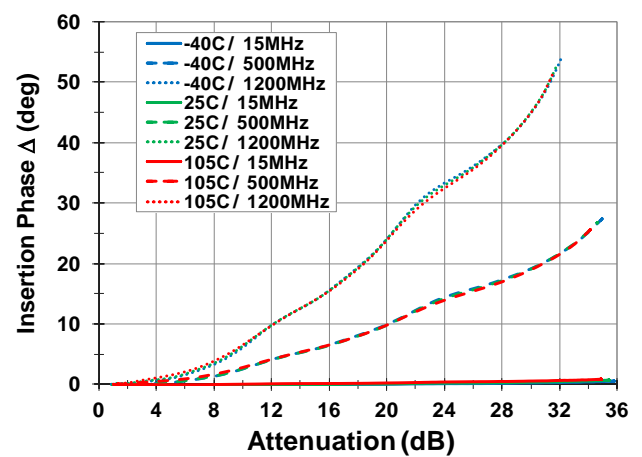

## Voltage Variable RF Attenuator

1MHz to 3000MHz

### TYPICAL OPERATING CONDITIONS [S2P vs. FREQUENCY] (-5-)

Min. & Max. Attenuation vs. Frequency

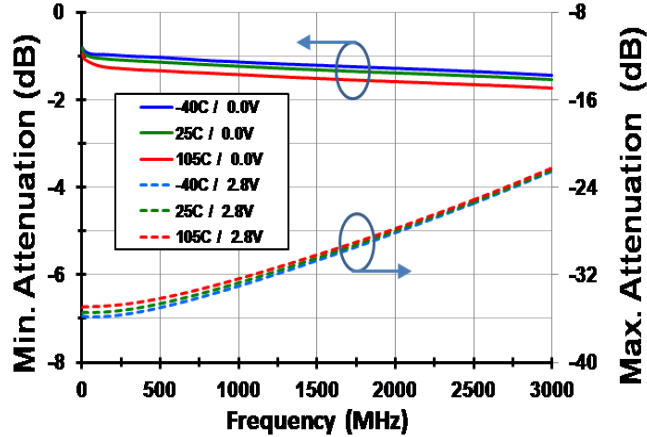

Min. & Max. Attenuation Slope vs. Frequency

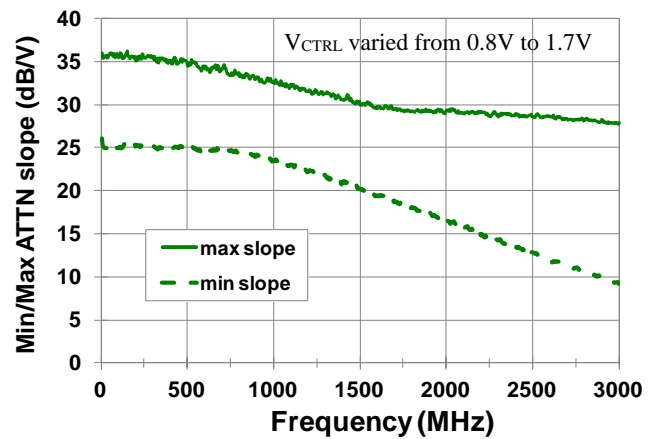

Worst-Case RF1 Return Loss vs. Frequency

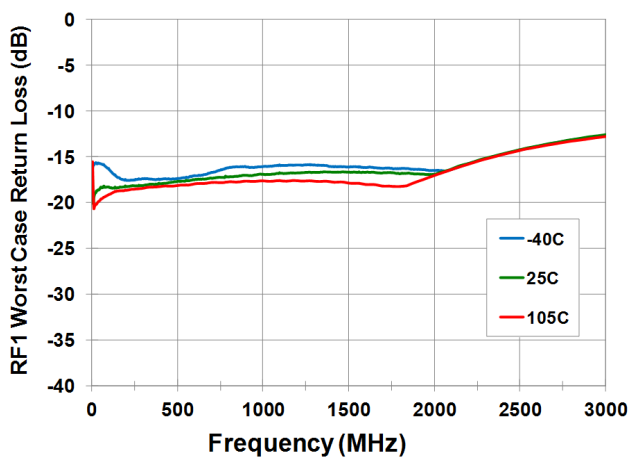

Worst-Case RF2 Return Loss vs. Frequency

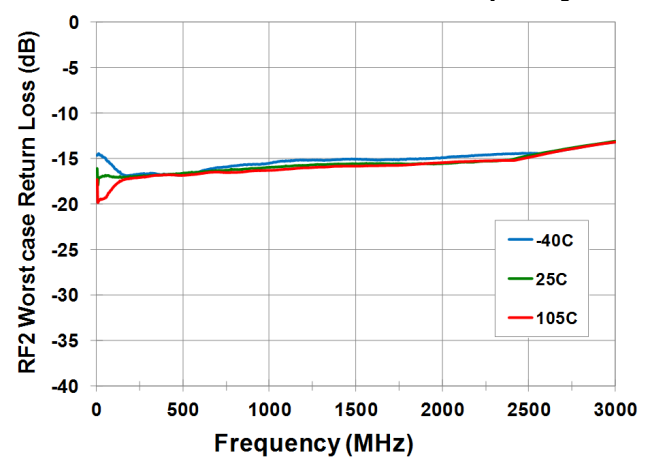

Max. Insertion Phase Δ vs. Frequency

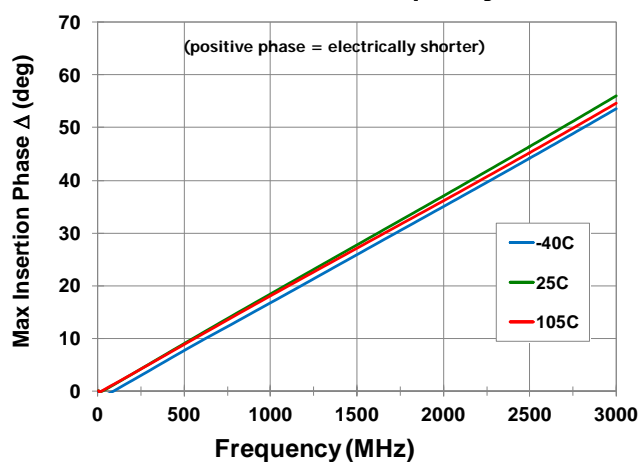

Gain Compression vs. Frequency

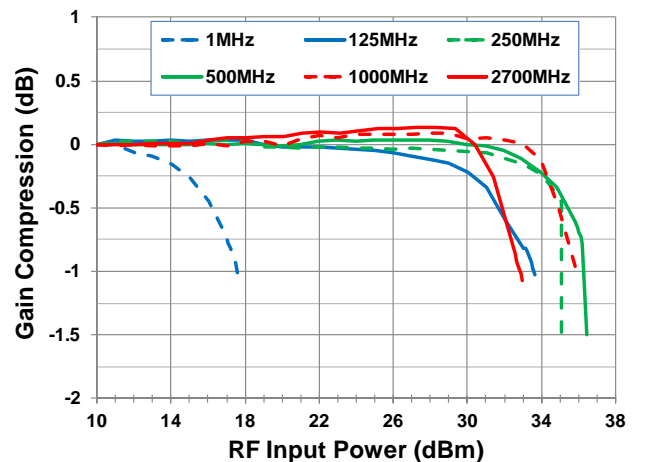

## Voltage Variable RF Attenuator

1MHz to 3000MHz

### TYPICAL OPERATING CONDITIONS [S2P @ LOW FREQUENCY, GROUP DELAY] (-6-)

Min. & Max. Attenuation vs. Low Frequency

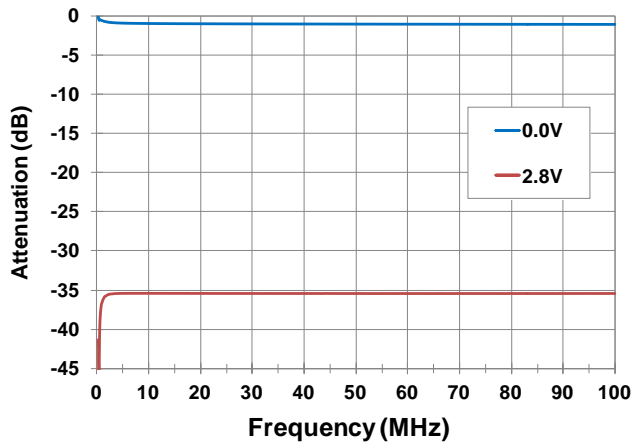

Low-Frequency Attenuation vs.  $V_{CTRL}$

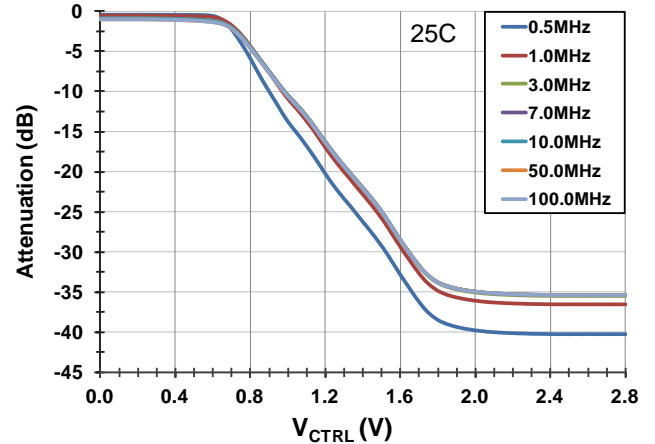

Low-Frequency RF1 Return Loss vs.  $V_{CTRL}$

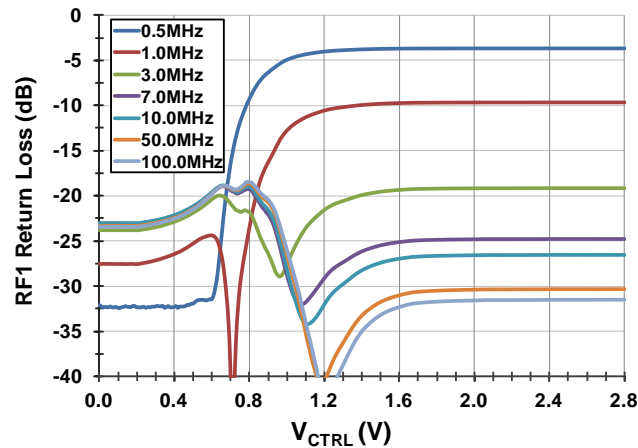

Low-Frequency RF2 Return Loss vs.  $V_{CTRL}$

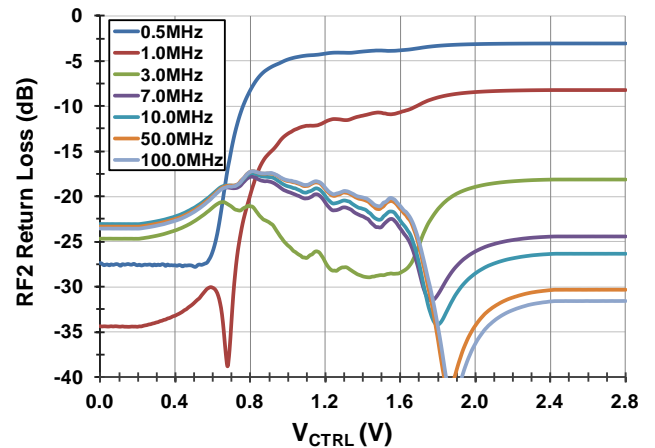

Group Delay vs. Frequency

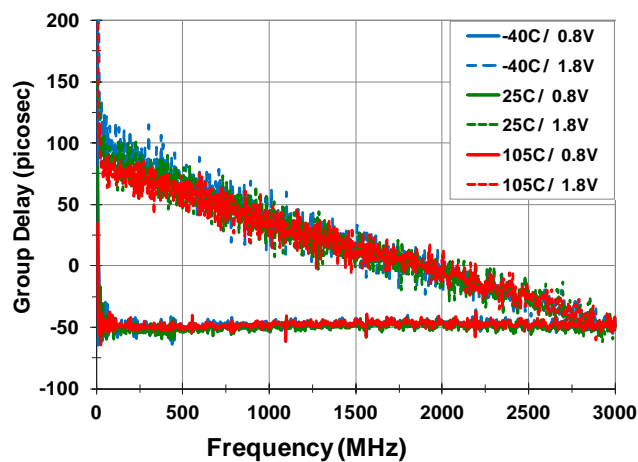

## Voltage Variable RF Attenuator

1MHz to 3000MHz

TYPICAL OPERATING CONDITIONS 500MHz,  $V_{DD}=3.3V$  [IP3, IP2, IH2, IH3 vs.  $V_{CTRL}$ ,  $V_{MODE}$ ] (-7-)

Input IP3 vs.  $V_{CTRL}$

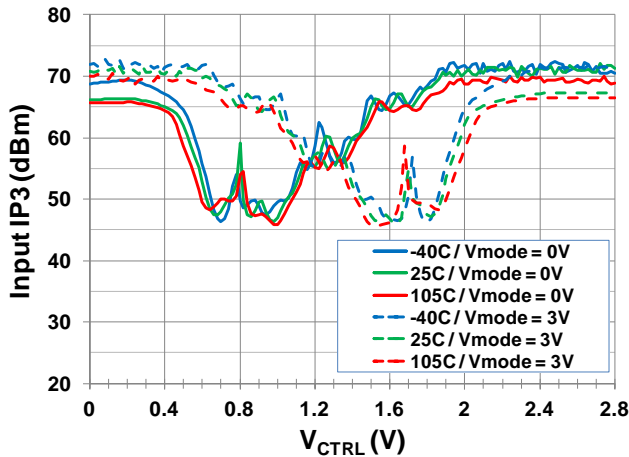

Output IP3 vs.  $V_{CTRL}$

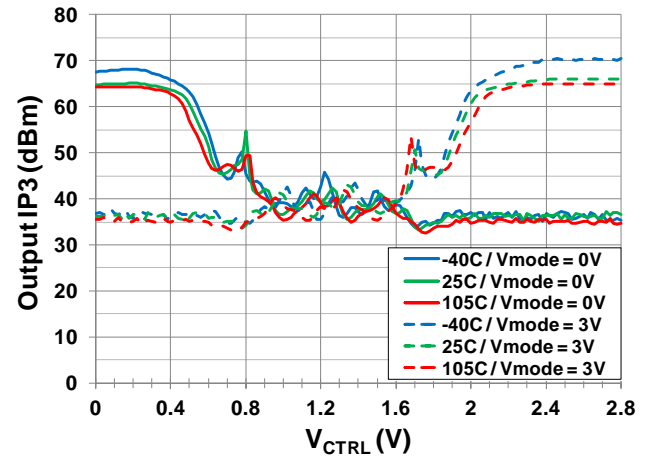

Input IP2 vs.  $V_{CTRL}$

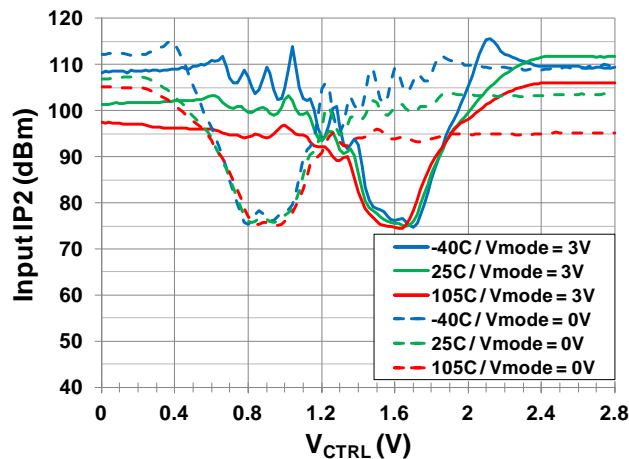

Output IP2 vs.  $V_{CTRL}$

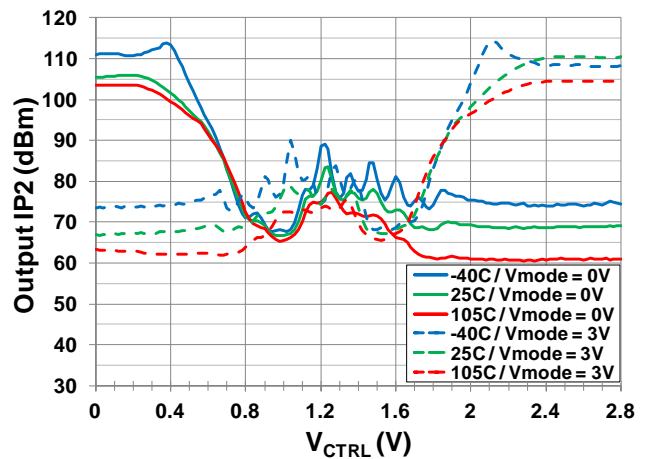

2<sup>nd</sup> Harm Input Intercept Point vs.  $V_{CTRL}$

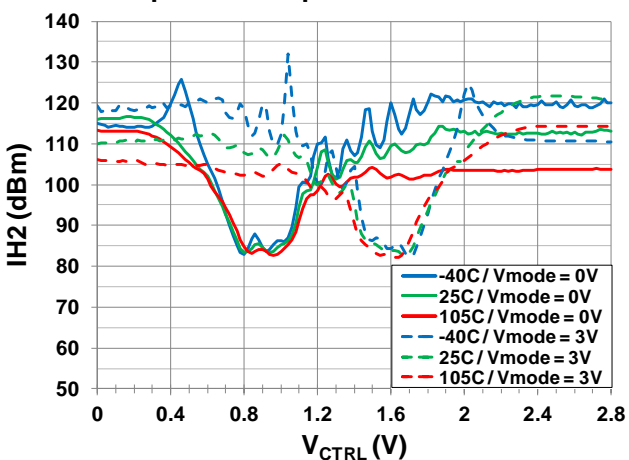

3<sup>rd</sup> Harm Input Intercept Point vs.  $V_{CTRL}$

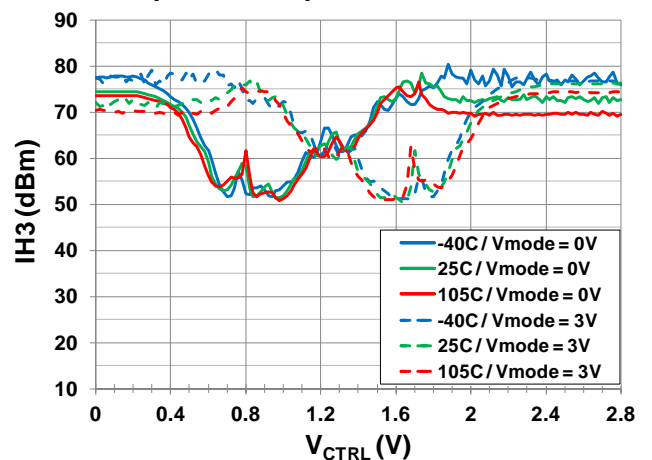

## Voltage Variable RF Attenuator

1MHz to 3000MHz

TYPICAL OPERATING CONDITIONS 500MHz,  $V_{DD}=3.3V$  [IPX, IHX vs.  $V_{CTRL}$ , RF1/RF2 DRIVEN] (-8-)

Input IP3 vs.  $V_{CTRL}$

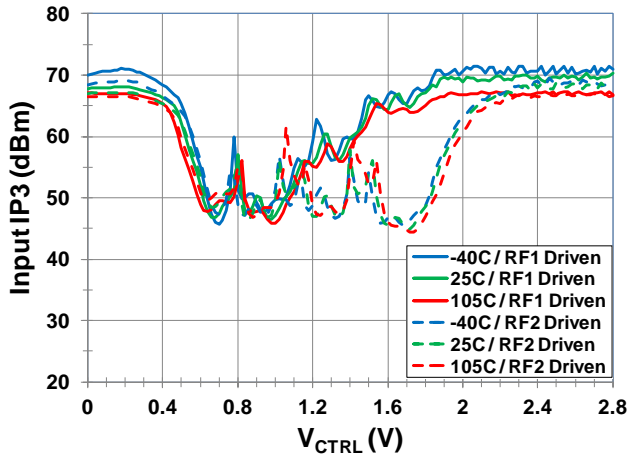

Output IP3 vs.  $V_{CTRL}$

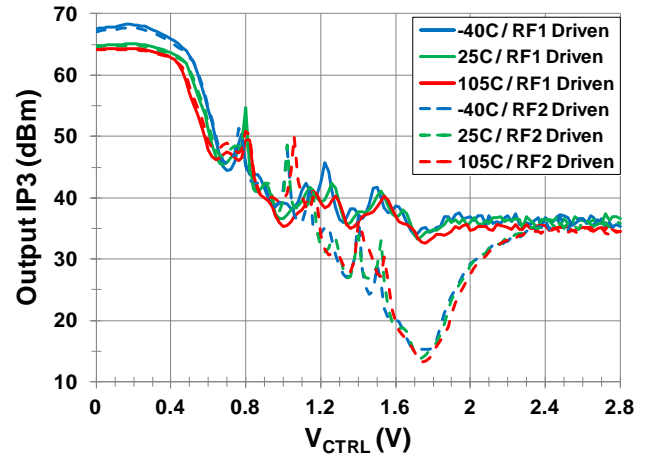

Input IP2 vs.  $V_{CTRL}$

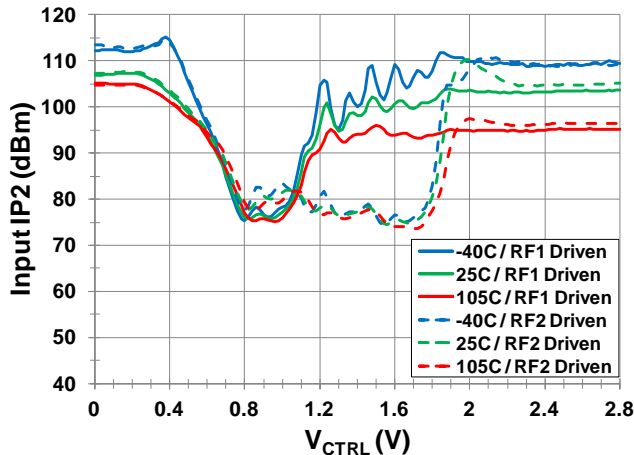

Output IP2 vs.  $V_{CTRL}$

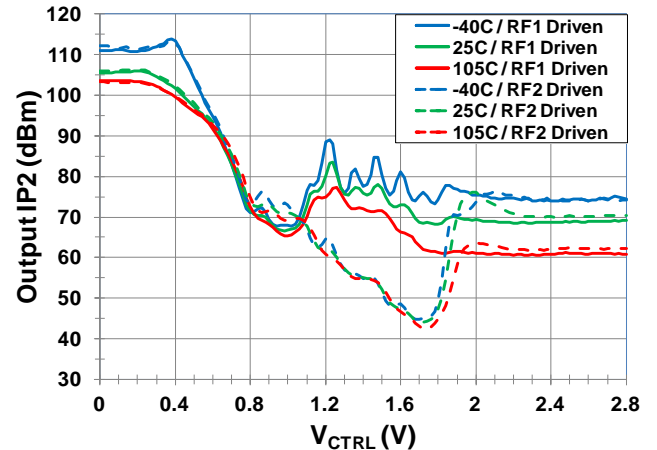

2<sup>nd</sup> Harm Input Intercept Point vs.  $V_{CTRL}$

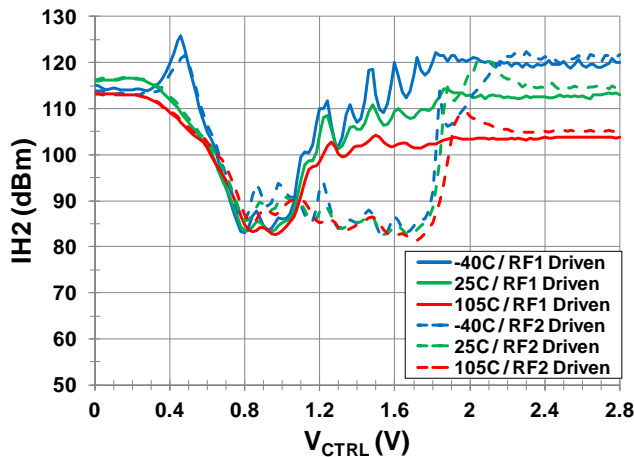

3<sup>rd</sup> Harm Input Intercept Point vs.  $V_{CTRL}$

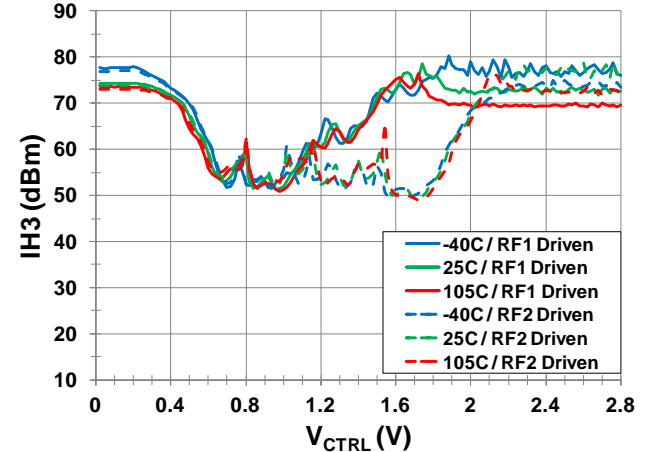

## Voltage Variable RF Attenuator

1MHz to 3000MHz

TYPICAL OPERATING CONDITIONS 500MHz,  $V_{DD}=3.3V$  [IP3, IP2, IH2, IH3 vs. ATTENUATION] (-9-)

Input IP3 vs. Attenuation

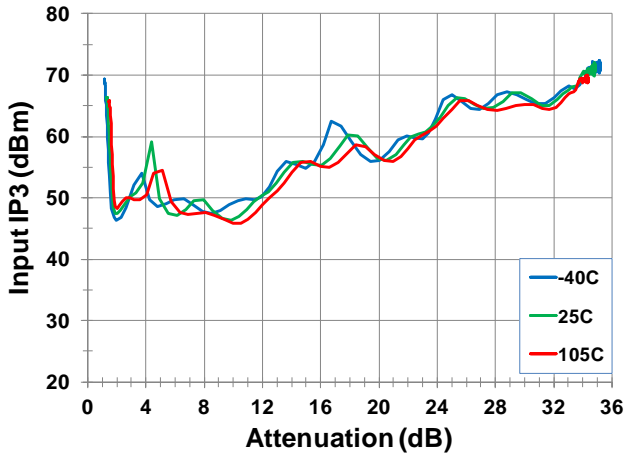

Output IP3 vs. Attenuation

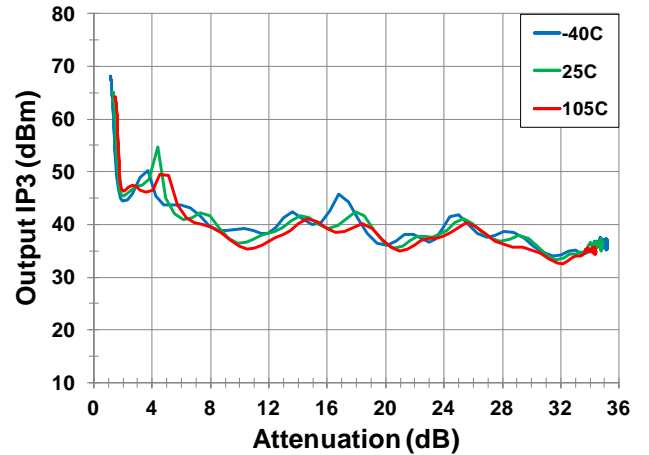

Input IP2 vs. Attenuation

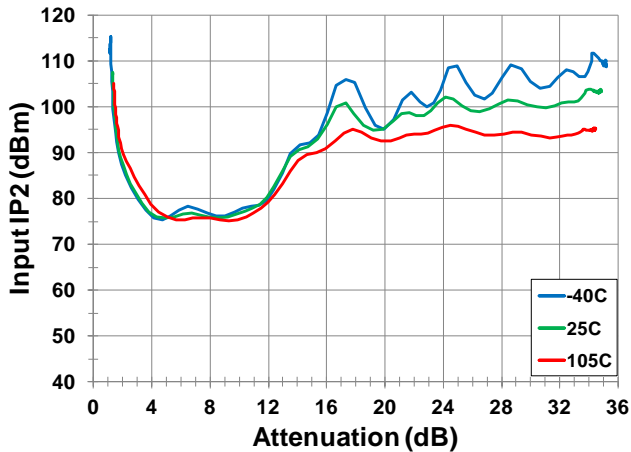

Output IP2 vs. Attenuation

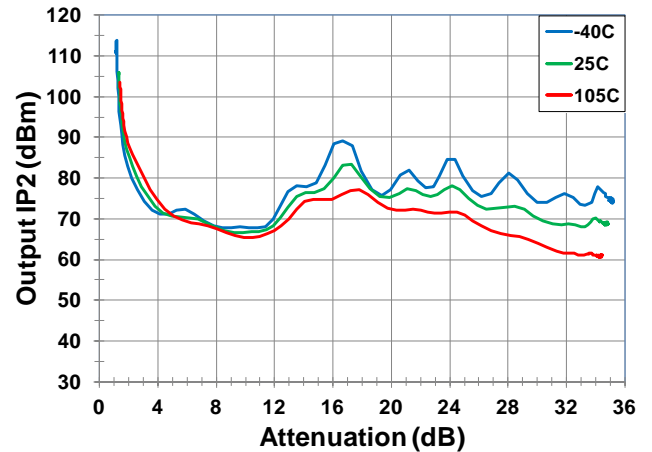

2<sup>nd</sup> Harm Input Intercept Point vs. Attenuation

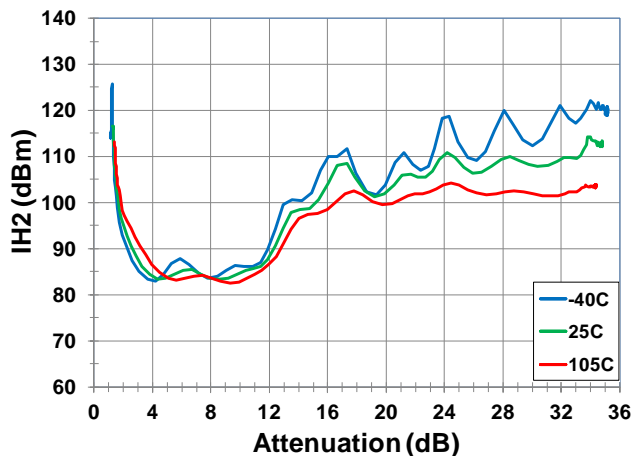

3<sup>rd</sup> Harm Input Intercept Point vs. Attenuation

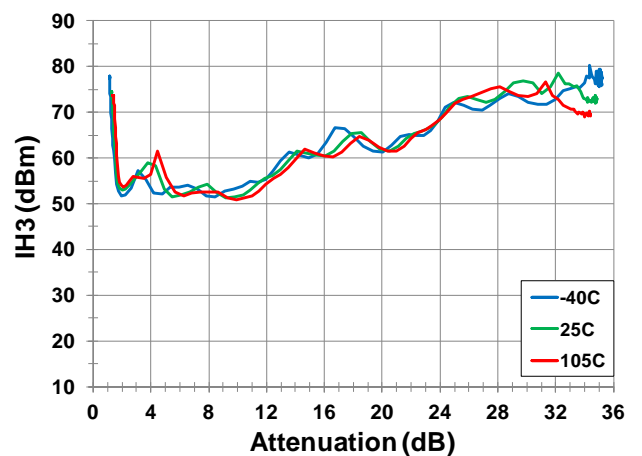

## Voltage Variable RF Attenuator

1MHz to 3000MHz

TYPICAL OPERATING CONDITIONS 500MHz,  $V_{DD}=3.3V$  [IP<sub>X</sub>, IH<sub>X</sub> vs. ATTEN, RF1/RF2 DRIVEN] (-10-)

Input IP3 vs. Attenuation

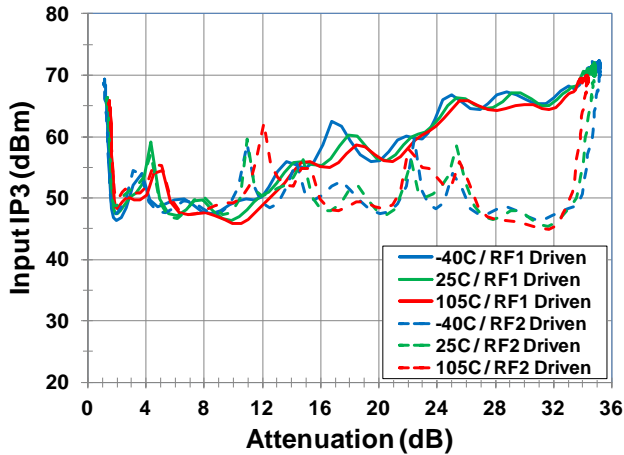

Output IP3 vs. Attenuation

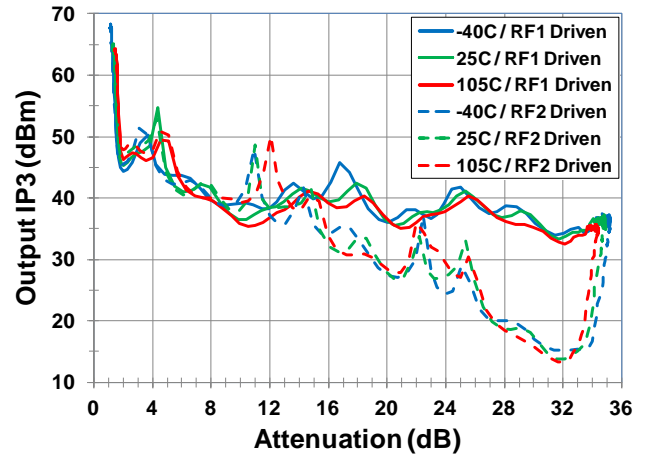

Input IP2 vs. Attenuation

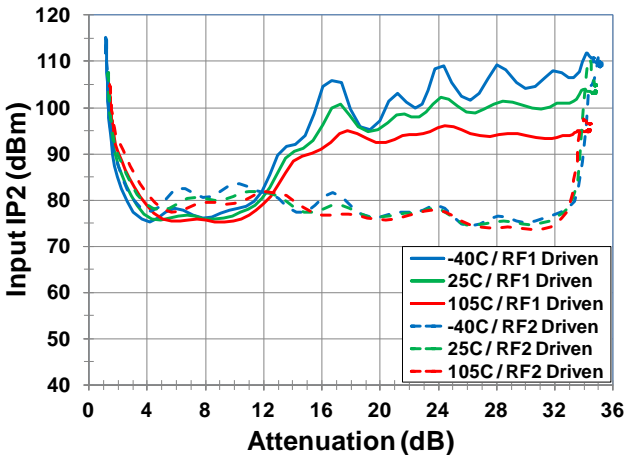

Output IP2 vs. Attenuation

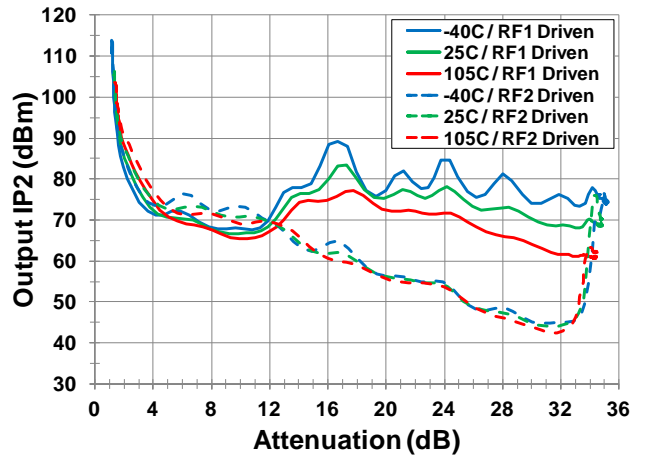

2<sup>nd</sup> Harm Input Intercept Point vs. Attenuation

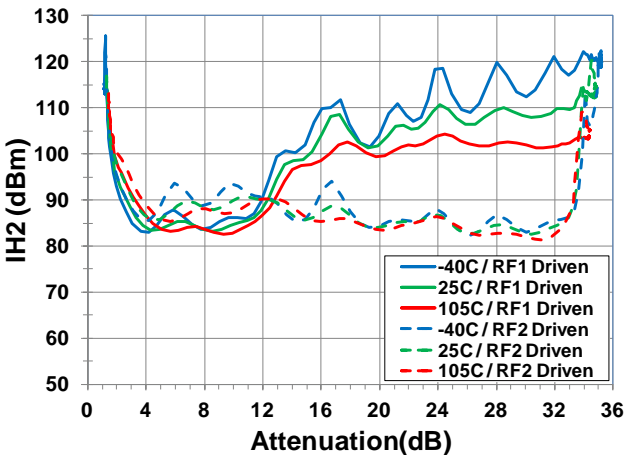

3<sup>rd</sup> Harm Input Intercept Point vs. Attenuation

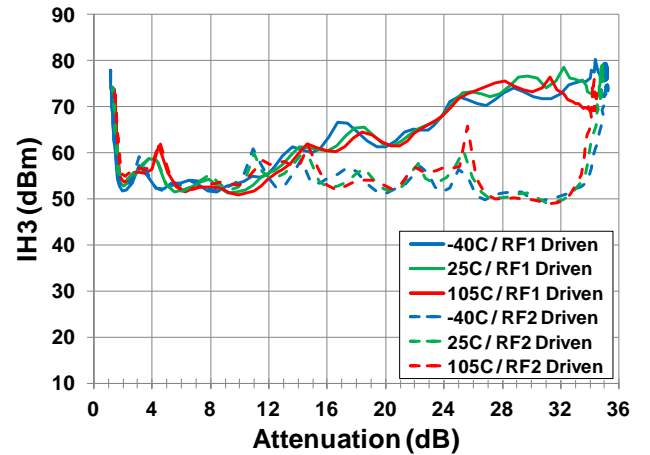

## Voltage Variable RF Attenuator

1MHz to 3000MHz

### PACKAGE OUTLINE DRAWING

The package outline drawings are located at the end of this document and are accessible from the Renesas website (see also [16-VFQFPN](#)). The package information is the most current data available and is subject to change without revision of this document.

### PINOUT & BLOCK DIAGRAM

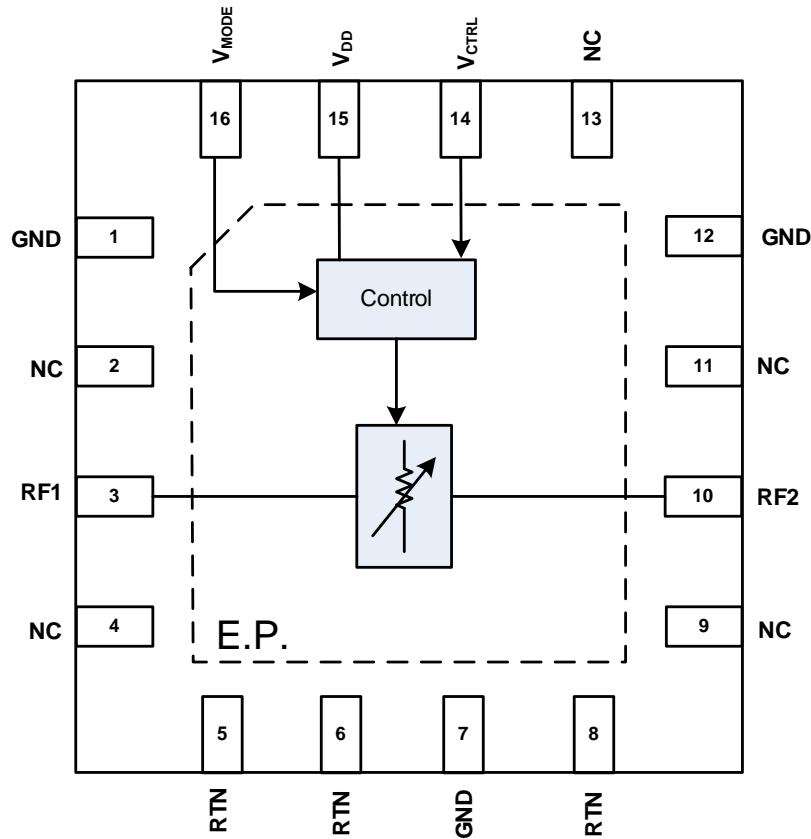

**Voltage Variable RF Attenuator**
**1MHz to 3000MHz**
**PIN DESCRIPTION**

Pin	Name	Function
1, 7, 12	GND	Ground these pins as close to the device as possible.
2, 4, 9, 11, 13	NC	No internal connection. Renesas recommends connecting these pins to GND.
3	RF1	RF Port 1. Matched to 50 ohms. Must use an external AC coupling capacitor as close to the device as possible. For low frequency operation increase the capacitor value to result in a low reactance at the frequency of interest.
5, 6, 8	RTN	Attenuator Ground Return. Each of these pins require a capacitor to GND to provide an RF return path. Place the capacitor as close to the device as possible.
10	RF2	RF Port 2. Matched to 50 ohms. Must use an external AC coupling capacitor as close to the device as possible. For low frequency operation increase the capacitor value to result in a low reactance at the frequency of interest.
14	V <sub>CTRL</sub>	Attenuator control voltage. Apply a voltage in the range as specified in the Operating Conditions Table. See application section for details about V <sub>CTRL</sub> .
15	V <sub>DD</sub>	Power supply input. Bypass to GND with capacitors close as possible to pin.
16	V <sub>MODE</sub>	Attenuator slope control. Set to logic LOW to enable negative attenuation slope. Set to logic HIGH to enable positive attenuation slope.
	— EP	Exposed Pad. Internally connected to GND. Solder this exposed pad to a PCB pad that uses multiple ground vias to achieve the specified RF performance.

**Voltage Variable RF Attenuator**
**1MHz to 3000MHz**
**APPLICATIONS INFORMATION**
**Default Start-up**

$V_{MODE}$  must be tied to either GND or Logic High. If the  $V_{CTRL}$  pin is left floating, the part will power up in the minimum attenuation state when  $V_{MODE} = GND$ , or the maximum attenuation state when  $V_{MODE} = High$ .

 **$V_{CTRL}$** 

The voltage level on the  $V_{CTRL}$  pin is used to control the attenuation of the F2255. At  $V_{CTRL} = 0V$ , the attenuation is a minimum (maximum) in the negative (positive) slope mode. An increasing (decreasing) voltage on  $V_{CTRL}$  produces an increasing (decreasing) attenuation respectively. The  $V_{CTRL}$  pin has an on-chip pull-up ESD diode so  $V_{DD}$  should be applied before  $V_{CTRL}$  is applied (see Recommended Operating Conditions for details). If this sequencing is not possible, then resistor R2 in the application circuit should be set to 1k $\Omega$  to limit the current into the  $V_{CTRL}$  pin.

 **$V_{MODE}$** 

The  $V_{MODE}$  pin is used to set the slope of the attenuation. The attenuation is varied by  $V_{CTRL}$  as described in the next section. Setting  $V_{MODE}$  to a logic LOW (HIGH) will set the attenuation slope to negative (positive). A negative (positive) slope is defined as an increased (decreased) attenuation with increasing  $V_{CTRL}$  voltage. The Evaluation Kit provides an on-board jumper to manually set the  $V_{MODE}$ . Install a jumper on header J2 from  $V_{MODE}$  to the pin marked Lo (Hi) to set the device for a negative (positive) slope (see application circuit).

**RF1 and RF2 Ports**

The F2255 is a bi-directional device, allowing RF1 or RF2 to be used as the RF input. RF1 has some enhanced linearity performance, and therefore should be used as the RF input, when possible, for best results. The F2255 has been designed to accept high RF input power levels; therefore,  $V_{DD}$  must be applied prior to the application of RF power to ensure reliability. DC blocking capacitors are required on the RF pins and should be set to a value that results in a low reactance over the frequency range of interest.

**Power Supplies**

The supply pin should be bypassed with external capacitors to minimize noise and fast transients. Supply noise can degrade noise figure and fast transients can trigger ESD clamps and cause them to fail. Supply voltage change or transients should have a slew rate smaller than 1V/20uS. In addition, all control pins should remain at 0V (+/-0.3V) while the supply voltage ramps or while it returns to zero.

## Voltage Variable RF Attenuator

1MHz to 3000MHz

### Control Pin Interface

If control signal integrity is a concern and clean signals cannot be guaranteed due to overshoot, undershoot, ringing, etc., the following circuit at the input of control pins 14 and 16 is recommended as shown below.

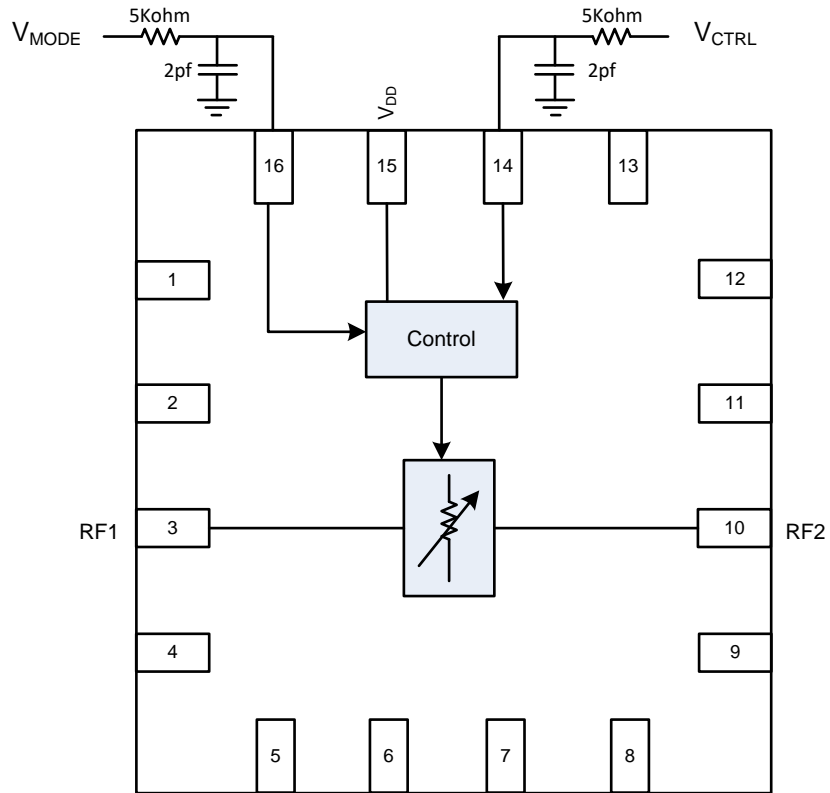

## Voltage Variable RF Attenuator

1MHz to 3000MHz

### EVKIT / APPLICATIONS CIRCUIT

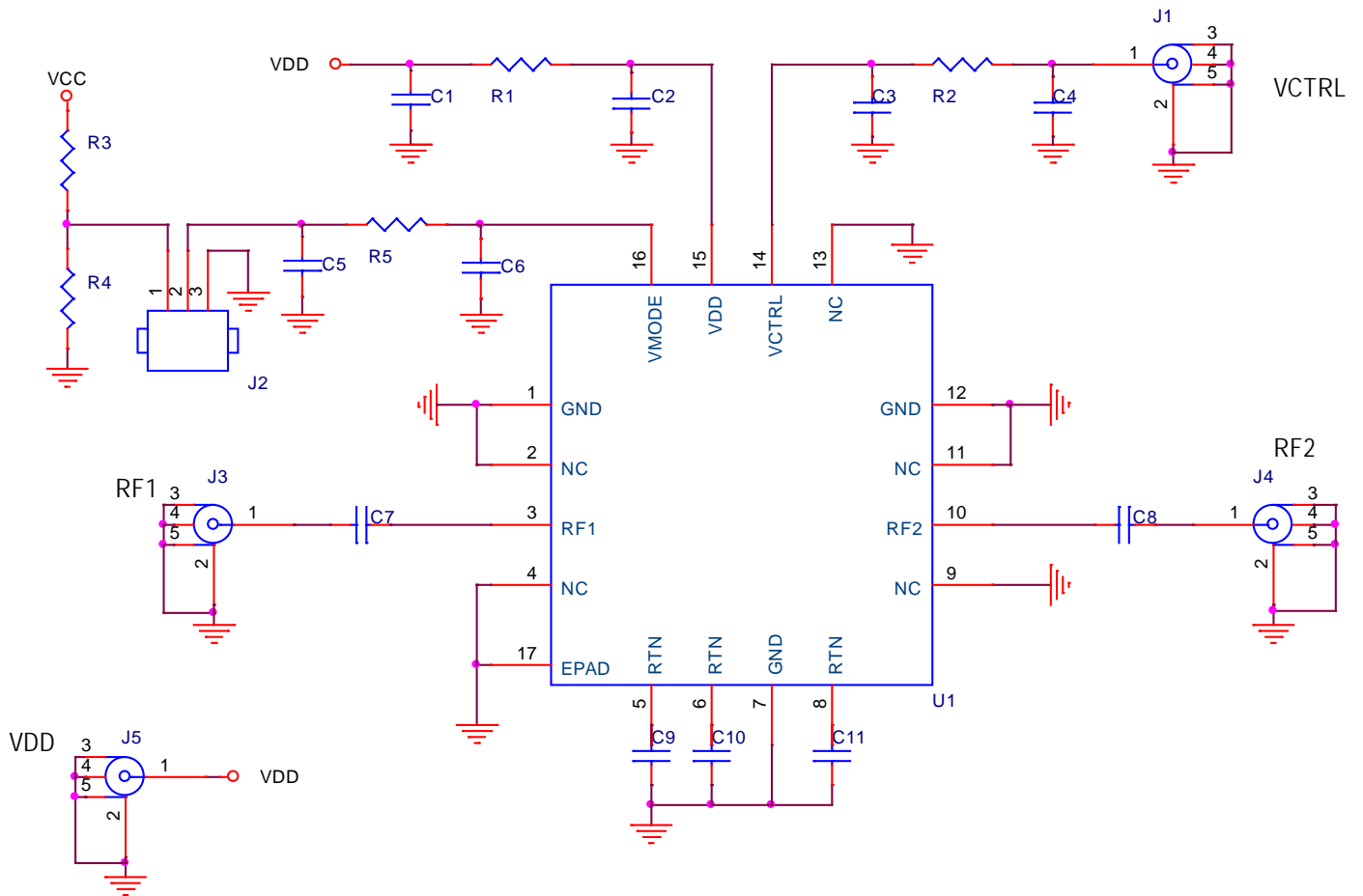

## Voltage Variable RF Attenuator

1MHz to 3000MHz

### EVKIT PICTURE / LAYOUT (TOP VIEW)

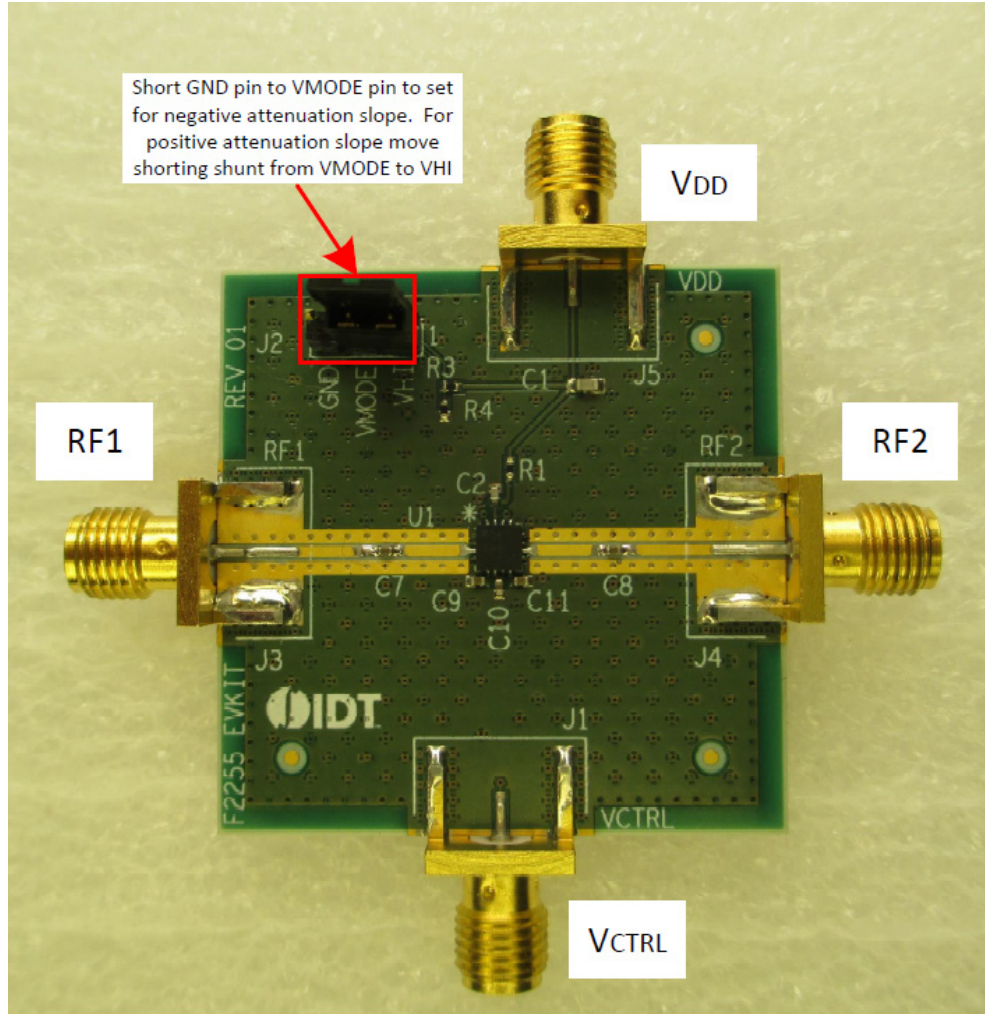

Voltage Variable RF Attenuator

1MHz to 3000MHz

EVKIT PICTURE / LAYOUT (BOTTOM VIEW)

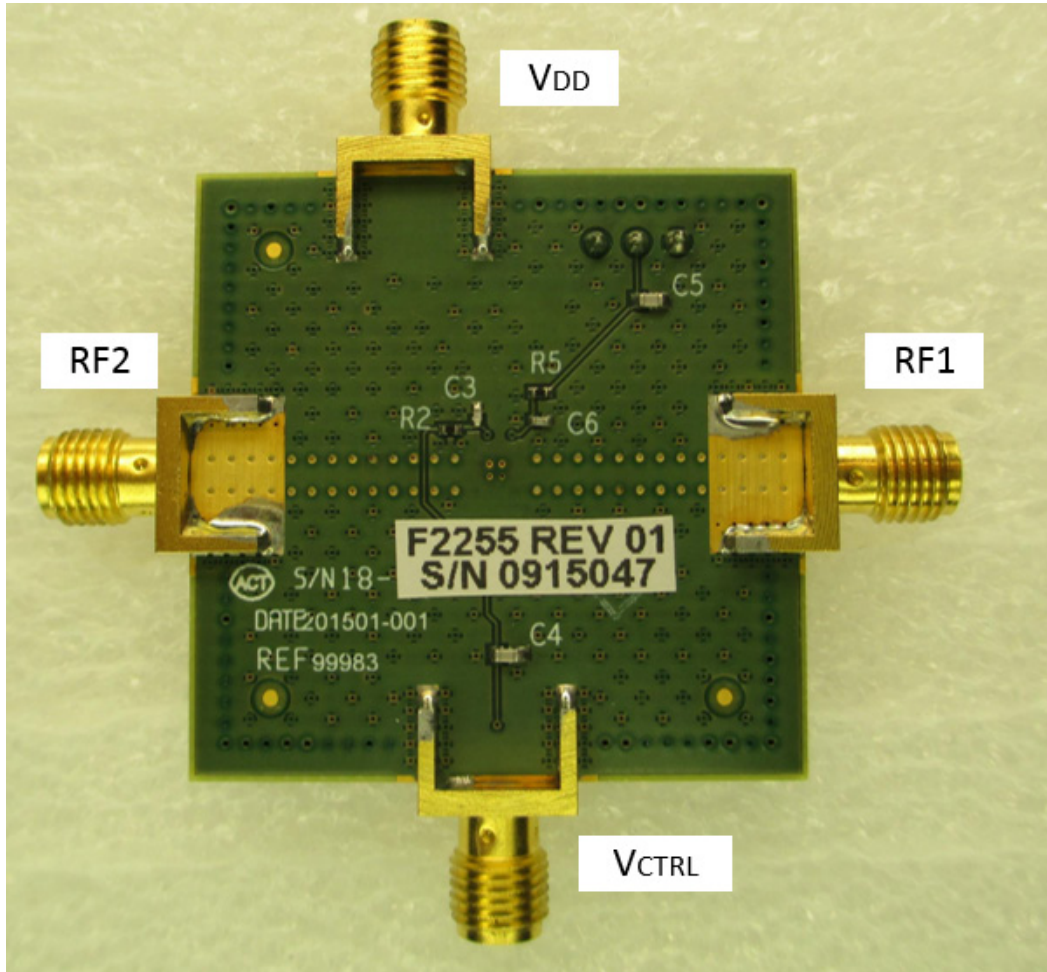

## Voltage Variable RF Attenuator

1MHz to 3000MHz

### EVKIT BOM

Part Reference	QTY	DESCRIPTION	Mfr. Part #	Mfr.
C1, C4, C5	3	10nF ±5%, 50V, X7R Ceramic Capacitors (0603)	GRM188R71H103J	Murata
C2, C3, C6	3	1000pF ±5%, 50V, COG Ceramic Capacitors (0402)	GRM1555C1H102J	Murata
C7, C8, C9, C10, C11	5	100nF ±10%, 16V, X7R Ceramic Capacitors (0402)	GRM155R71C104K	Murata
R1, R2, R5	3	0Ω Resistors (0402)	ERJ-2GE0R00X	Panasonic
R3, R4	2	100kΩ ±1%, 1/10W, Resistors (0402)	ERJ-2RKF1003X	Panasonic
J1, J3, J4, J5	4	Edge Launch SMA (0.375 inch pitch ground tabs)	142-0701-851	Emerson Johnson
J2	1	CONN HEADER VERT SGL 3 X 1 POS GOLD	961103-6404-AR	3M
U1	1	Voltage Variable Attenuator	F2255NLGK	IDT
	1	Printed Circuit Board	F2255 REV 1	IDT

### TOP MARKINGS

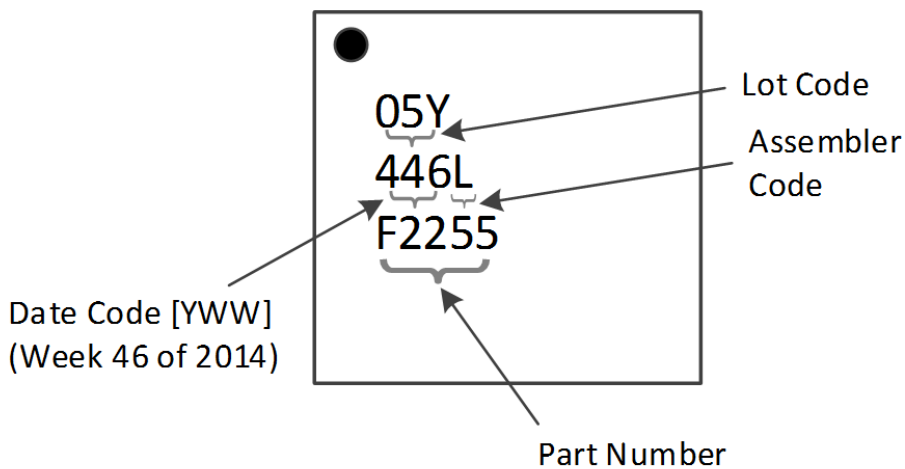

**Voltage Variable RF Attenuator****1MHz to 3000MHz**

## Revision History

Revision Date	Description of Change
May 7, 2021	<ul style="list-style-type: none"><li>• Changed the corporate branding to Renesas.</li><li>• Completed other minor changes.</li></ul>
February 9, 2018	Corrected POD drawing, added revision page.
January 30, 2017	Updated GBT limits for $I_{DD}$ , $V_{MODE}$ and $V_{CTRL}$ .
November 5, 2015	Initial release.

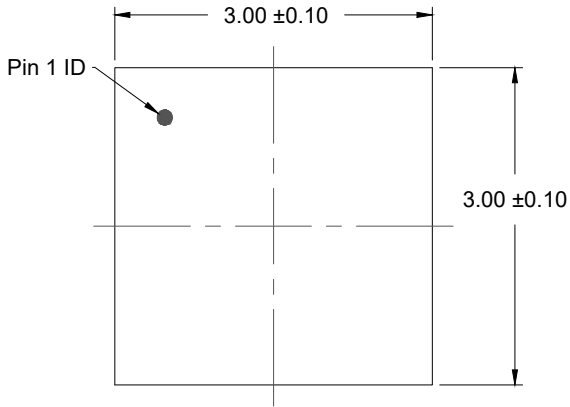

TOP VIEW

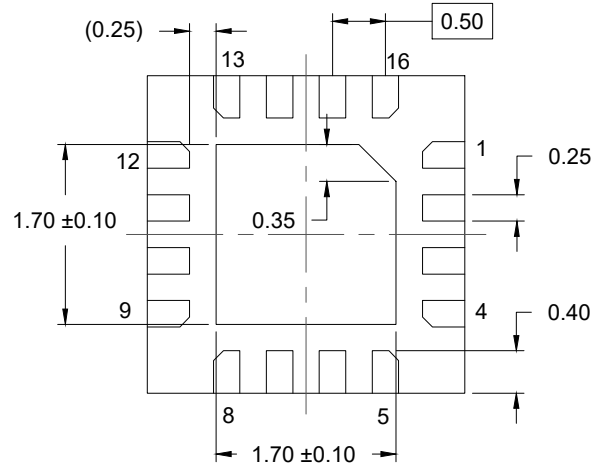

BOTTOM VIEW

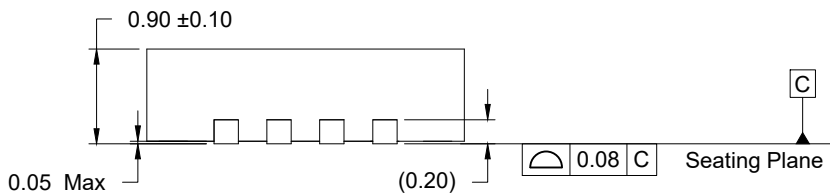

SIDE VIEW

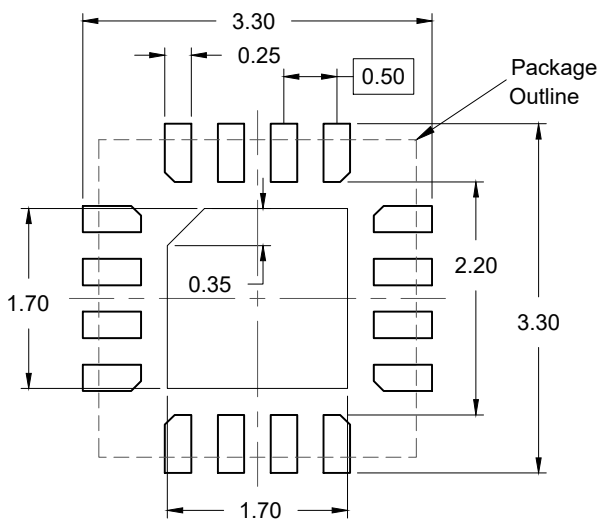

RECOMMENDED LAND PATTERN  
(PCB Top View, NSMD Design)

**NOTES:**

1. JEDEC compatible.
2. All dimensions are in mm and angles are in degrees.
3. Use  $\pm 0.05$  mm for the non-toleranced dimensions.
4. Numbers in ( ) are for references only.

## IMPORTANT NOTICE AND DISCLAIMER

RENESAS ELECTRONICS CORPORATION AND ITS SUBSIDIARIES (“RENESAS”) PROVIDES TECHNICAL SPECIFICATIONS AND RELIABILITY DATA (INCLUDING DATASHEETS), DESIGN RESOURCES (INCLUDING REFERENCE DESIGNS), APPLICATION OR OTHER DESIGN ADVICE, WEB TOOLS, SAFETY INFORMATION, AND OTHER RESOURCES “AS IS” AND WITH ALL FAULTS, AND DISCLAIMS ALL WARRANTIES, EXPRESS OR IMPLIED, INCLUDING, WITHOUT LIMITATION, ANY IMPLIED WARRANTIES OF MERCHANTABILITY, FITNESS FOR A PARTICULAR PURPOSE, OR NON-INFRINGEMENT OF THIRD-PARTY INTELLECTUAL PROPERTY RIGHTS.

These resources are intended for developers who are designing with Renesas products. You are solely responsible for (1) selecting the appropriate products for your application, (2) designing, validating, and testing your application, and (3) ensuring your application meets applicable standards, and any other safety, security, or other requirements. These resources are subject to change without notice. Renesas grants you permission to use these resources only to develop an application that uses Renesas products. Other reproduction or use of these resources is strictly prohibited. No license is granted to any other Renesas intellectual property or to any third-party intellectual property. Renesas disclaims responsibility for, and you will fully indemnify Renesas and its representatives against, any claims, damages, costs, losses, or liabilities arising from your use of these resources. Renesas' products are provided only subject to Renesas' Terms and Conditions of Sale or other applicable terms agreed to in writing. No use of any Renesas resources expands or otherwise alters any applicable warranties or warranty disclaimers for these products.

(Disclaimer Rev.1.01 Jan 2024)

### Corporate Headquarters

TOYOSU FORESIA, 3-2-24 Toyosu,  
Koto-ku, Tokyo 135-0061, Japan  
[www.renesas.com](http://www.renesas.com)

### Trademarks



Renesas and the Renesas logo are trademarks of Renesas Electronics Corporation. All trademarks and registered trademarks are the property of their respective owners.

### Contact Information

For further information on a product, technology, the most up-to-date version of a document, or your nearest sales office, please visit [www.renesas.com/contact-us/](http://www.renesas.com/contact-us/).

## Looking for pricing, stock, or lifecycle information?

Click below to explore more details on WIN SOURCE:

-  [View F2255NLGK8 on WIN SOURCE](#)
-  [Renesas Electronics America](#) Information

## Optimize Your Supply Chain with WIN SOURCE Solutions

-  Global Sourcing Solution
-  Obsolete Management
-  Cost Control Management
-  Shortage Management
-  Alternative Solution
-  Excess Inventory Management