



**THE DATASHEET OF  
MDMA120U1600VA**



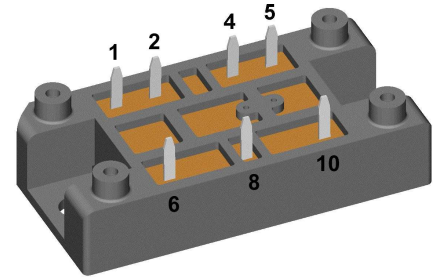
# Standard Rectifier Module

<b>3~ Rectifier</b>
$V_{RRM} = 1600\text{ V}$
$I_{DAV} = 120\text{ A}$
$I_{FSM} = 850\text{ A}$


## 3~ Rectifier Bridge

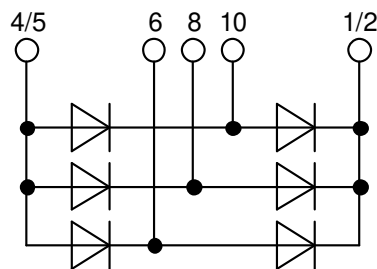
Part number

**MDMA120U1600VA**



Backside: isolated

 E72873



### Features / Advantages:

- Package with DCB ceramic
- Improved temperature and power cycling
- Planar passivated chips
- Very low forward voltage drop
- Very low leakage current

### Applications:

- Diode for main rectification
- For three phase bridge configurations
- Supplies for DC power equipment
- Input rectifiers for PWM inverter
- Battery DC power supplies
- Field supply for DC motors

### Package: V1-A-Pack

- Isolation Voltage: 3600 V~
- Industry standard outline
- RoHS compliant
- Soldering pins for PCB mounting
- Height: 17 mm
- Base plate: DCB ceramic
- Reduced weight
- Advanced power cycling

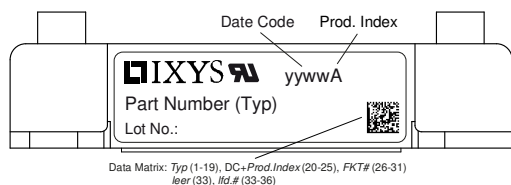
### Disclaimer Notice

Information furnished is believed to be accurate and reliable. However, users should independently evaluate the suitability of and test each product selected for their own applications. Littelfuse products are not designed for, and may not be used in, all applications. Read complete Disclaimer Notice at [www.littelfuse.com/disclaimer-electronics](http://www.littelfuse.com/disclaimer-electronics).

Rectifier				Ratings			
Symbol	Definition	Conditions		min.	typ.	max.	Unit
$V_{RSM}$	max. non-repetitive reverse blocking voltage					1700	V
$V_{RRM}$	max. repetitive reverse blocking voltage					1600	V
$I_R$	reverse current	$V_R = 1600$ V		$T_{VJ} = 25^\circ\text{C}$		40	$\mu\text{A}$
		$V_R = 1600$ V		$T_{VJ} = 150^\circ\text{C}$		1.5	mA
$V_F$	forward voltage drop	$I_F = 40$ A		$T_{VJ} = 25^\circ\text{C}$		1.09	V
		$I_F = 120$ A				1.42	V
		$I_F = 40$ A		$T_{VJ} = 125^\circ\text{C}$		1.03	V
		$I_F = 120$ A				1.47	V
$I_{DAV}$	bridge output current	$T_C = 110^\circ\text{C}$		$T_{VJ} = 150^\circ\text{C}$		120	A
		rectangular	$d = \frac{1}{3}$				
$V_{FO}$	threshold voltage			$T_{VJ} = 150^\circ\text{C}$		0.79	V
$r_F$	slope resistance					5.9	m $\Omega$
$R_{thJC}$	thermal resistance junction to case					0.65	K/W
$R_{thCH}$	thermal resistance case to heatsink				0.2		K/W
$P_{tot}$	total power dissipation			$T_C = 25^\circ\text{C}$		190	W
$I_{FSM}$	max. forward surge current	$t = 10$ ms; (50 Hz), sine		$T_{VJ} = 45^\circ\text{C}$		850	A
		$t = 8,3$ ms; (60 Hz), sine		$V_R = 0$ V		920	A
		$t = 10$ ms; (50 Hz), sine		$T_{VJ} = 150^\circ\text{C}$		725	A
		$t = 8,3$ ms; (60 Hz), sine		$V_R = 0$ V		780	A
$I^2t$	value for fusing	$t = 10$ ms; (50 Hz), sine		$T_{VJ} = 45^\circ\text{C}$		3.62	kA <sup>2</sup> s
		$t = 8,3$ ms; (60 Hz), sine		$V_R = 0$ V		3.52	kA <sup>2</sup> s
		$t = 10$ ms; (50 Hz), sine		$T_{VJ} = 150^\circ\text{C}$		2.63	kA <sup>2</sup> s
		$t = 8,3$ ms; (60 Hz), sine		$V_R = 0$ V		2.53	kA <sup>2</sup> s
$C_J$	junction capacitance	$V_R = 400$ V; $f = 1$ MHz		$T_{VJ} = 25^\circ\text{C}$		23	pF



Package V1-A-Pack		Ratings				
Symbol	Definition	Conditions	min.	typ.	max.	Unit
$I_{RMS}$	RMS current	per terminal			100	A
$T_{VJ}$	virtual junction temperature		-40		150	°C
$T_{op}$	operation temperature		-40		125	°C
$T_{stg}$	storage temperature		-40		125	°C
<b>Weight</b>				37		g
$M_D$	mounting torque		2		2.5	Nm
$d_{Spp/App}$	creepage distance on surface / striking distance through air	terminal to terminal	6.0			mm
$d_{Spb/Apb}$		terminal to backside	12.0			mm
$V_{ISOL}$	isolation voltage	t = 1 second t = 1 minute	3600 3000			V V
		50/60 Hz, RMS; $I_{ISOL} \leq 1$ mA				



Data Matrix: Typ (1-19), DC+Prod.Index (20-25), FKT# (26-31)  
leer (33), lld.# (33-36)

**Part description**

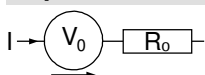
- M = Module
- D = Diode
- M = Standard Rectifier
- A = (up to 1800V)
- 120 = Current Rating [A]
- U = 3- Rectifier Bridge
- 1600 = Reverse Voltage [V]
- VA = V1-A-Pack

Ordering	Ordering Number	Marking on Product	Delivery Mode	Quantity	Code No.
Standard	MDMA120U1600VA	MDMA120U1600VA	Blister	24	526452

**Equivalent Circuits for Simulation**

\* on die level

$T_{VJ} = 150^{\circ}C$

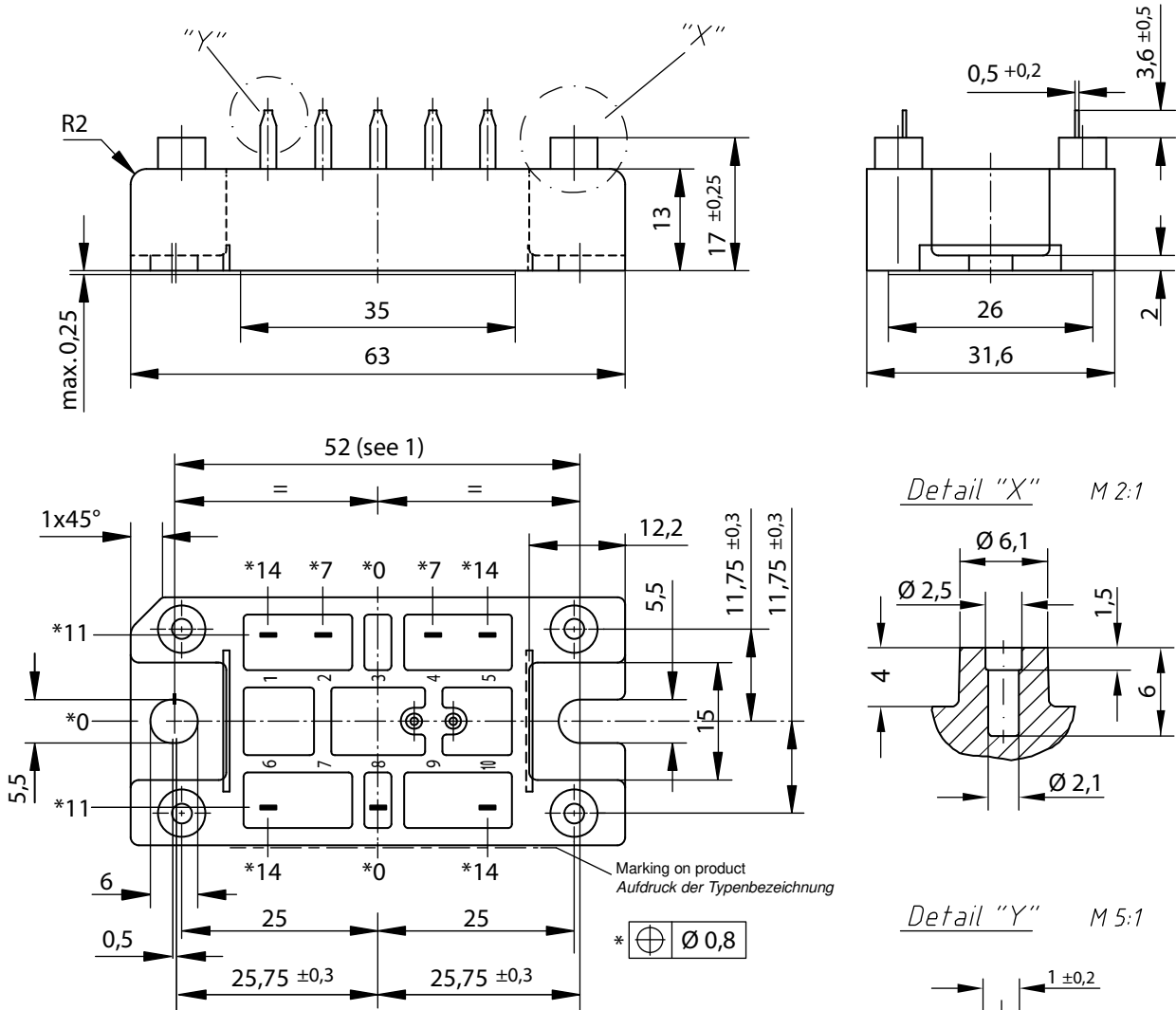


**Rectifier**

$V_{0\ max}$	threshold voltage	0.79	V
$R_{0\ max}$	slope resistance *	4.6	mΩ

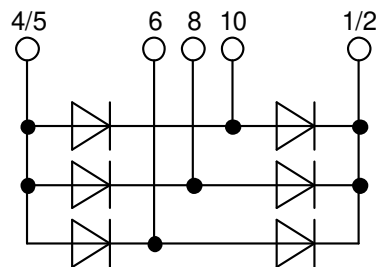


**Outlines V1-A-Pack**



**Remarks / Bemerkungen:**

1. Nominal distance mounting screws on heat sink: 52 mm / Nennabstand Befestigungsschrauben auf Kühlkörper: 52 mm
  2. General tolerance / Allgemeintoleranz: DIN ISO 2768 -T1-c
  3. Surface treatment of pins: tin plated (Sn) in hot dip / Oberflächenbehandlung der Pins: verzinkt (Sn) im Tauchbad
  4. Detail X: EJOT PT® self-tapping screws (dimension K25) to be recommended for mounting on PCB  
selbstschneidende Schraube (Größe K25) empfohlen für die PCB-Montage
- Take care on the maximum screw length according to board thickness and the maximum hole depth of 6 mm<sup>L</sup>  
Bei der Wahl der Schraubenlänge die PCB-Dicke und die maximale Lochtiefe von 6mm beachten
- Recommended mounting torque: 1.5 Nm / Empfohlenes Drehmoment: 1.5 Nm



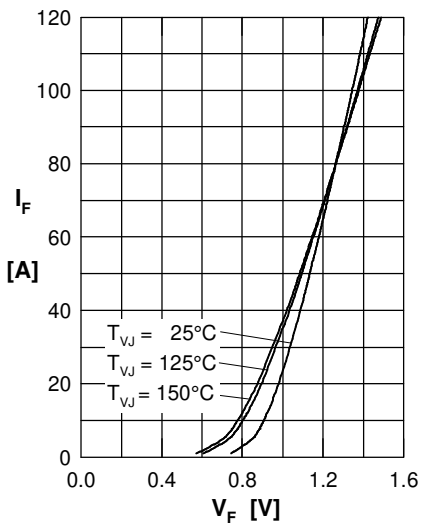
**Rectifier**


Fig. 1 Forward current versus voltage drop per diode

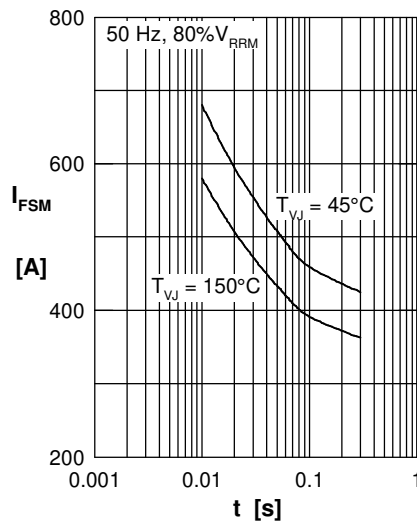


Fig. 2 Surge overload current vs. time per diode

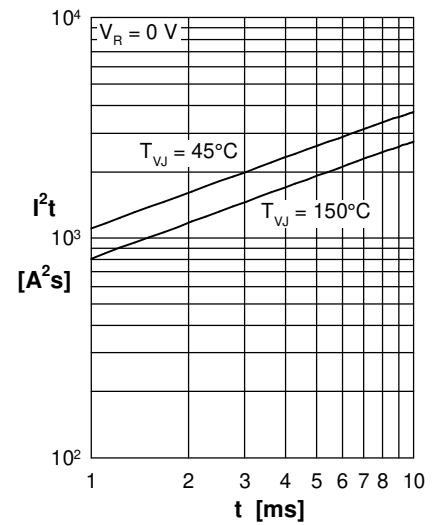
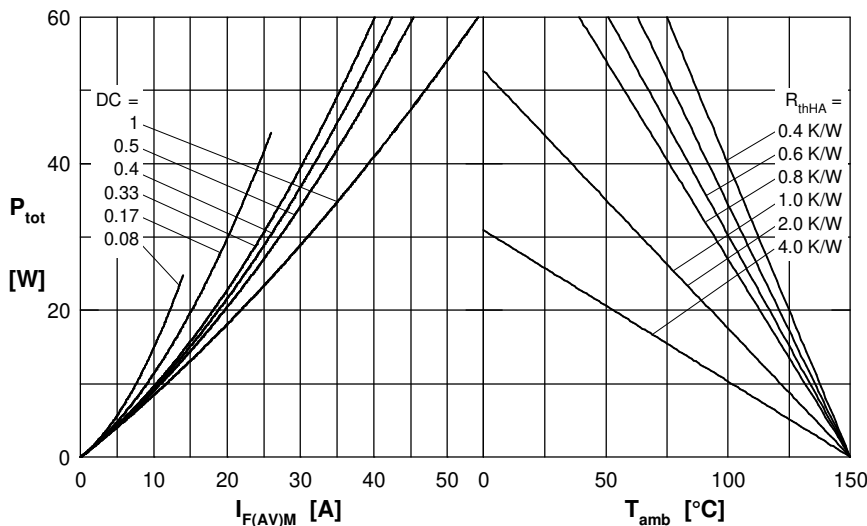

 Fig. 3  $I^2t$  versus time per diode


Fig. 4 Power dissipation vs. forward current and ambient temperature per diode

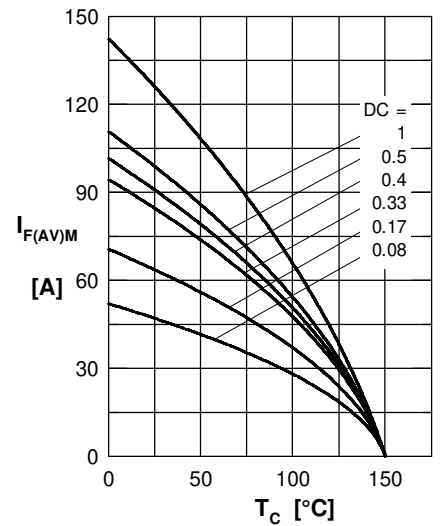


Fig. 5 Max. forward current vs. case temperature per diode

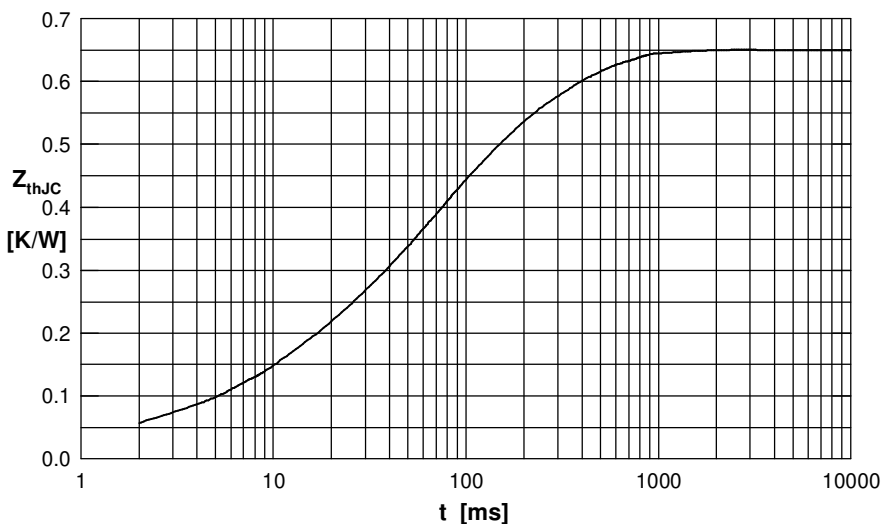




Fig. 6 Transient thermal impedance junction to case vs. time per diode

 Constants for  $Z_{thJC}$  calculation:

i	$R_{thi}$ (K/W)	$t_i$ (s)
1	0.032	0.001
2	0.098	0.010
3	0.305	0.060
4	0.215	0.270

## Looking for pricing, stock, or lifecycle information?

Click below to explore more details on WIN SOURCE:

-  View [MDMA120U1600VA](#) on WIN SOURCE
-  [IXYS](#) Information

## Optimize Your Supply Chain with WIN SOURCE Solutions

-  Global Sourcing Solution
-  Obsolete Management
-  Cost Control Management
-  Shortage Management
-  Alternative Solution
-  Excess Inventory Management