



**THE DATASHEET OF  
MAL214699006E3**



## Aluminum Electrolytic Capacitors SMD (Chip), High Temperature, Low Impedance

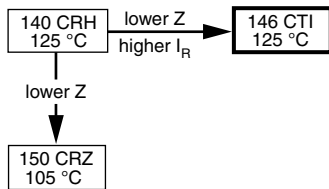

Fig. 1

 AUTOMOTIVE  
GRADE

**RoHS**  
COMPLIANT

### FEATURES

- Extended useful life: up to 6000 h at 125 °C
- Polarized aluminum electrolytic capacitors, non-solid electrolyte, self healing
- SMD-version with base plate, lead (Pb)-free reflow solderable
- Charge and discharge proof, no peak current limitation
- Advanced temperature reflow soldering according to JEDEC® J-STD-020
- Vibration proof, 4-pin version and 6-pin version
- AEC-Q200 qualified
- High reliability
- Low ESR
- Material categorization: for definitions of compliance please see [www.vishay.com/doc?99912](http://www.vishay.com/doc?99912)

### APPLICATIONS

- SMD technology, for high temperature reflow soldering
- Industrial and professional applications
- Automotive, general industrial, telecom
- Smoothing, filtering, buffering

### MARKING

- Rated capacitance (in  $\mu\text{F}$ )
- Rated voltage (in V)
- Date code, in accordance with IEC 60062
- Black mark or “-” sign indicating the cathode (the anode is identified by bevelled edges)
- Code indicating group number (T)

### PACKAGING

Supplied in blister tape on reel

QUICK REFERENCE DATA	
DESCRIPTION	VALUE
Nominal case sizes (L x W x H in mm)	8 x 8 x 10 to 18 x 18 x 21
Rated capacitance range, $C_R$	10 $\mu\text{F}$ to 4700 $\mu\text{F}$
Tolerance on $C_R$	$\pm 20\%$
Rated voltage range, $U_R$	16 V to 100 V
Category temperature range	-55 °C to +125 °C
Endurance test at 125 °C	1000 h to 5000 h
Useful life at 125 °C	1500 h to 6000 h
Useful life at 40 °C 1.8 x $I_R$ applied	150 000 h to 400 000 h
Shelf life at 0 V, 125 °C	1000 h
Based on sectional specification	IEC 60384-18 / CECC 32300
Climatic category IEC 60068	55 / 125 / 56

SELECTION CHART FOR $C_R$ , $U_R$ , AND RELEVANT NOMINAL CASE SIZES (L x W x H in mm)							
$C_R$ ( $\mu F$ )	$U_R$ (V)						
	16	25	35	50	63	80	100
10	→	→	→	→	→	10 x 10 x 10	10 x 10 x 10
22	→	→	→	→	10 x 10 x 10	10 x 10 x 10	10 x 10 x 10
33	→	→	8 x 8 x 10	→	10 x 10 x 10	10 x 10 x 10	10 x 10 x 12
47	→	→	10 x 10 x 10	10 x 10 x 10	10 x 10 x 10	10 x 10 x 12	10 x 10 x 12
68	→	→	→	10 x 10 x 10	10 x 10 x 10	10 x 10 x 12	12.5 x 12.5 x 13
100	→	8 x 8 x 10	10 x 10 x 10	10 x 10 x 10	10 x 10 x 12	12.5 x 12.5 x 13	12.5 x 12.5 x 16
150	→	→	10 x 10 x 10	10 x 10 x 12	12.5 x 12.5 x 13	12.5 x 12.5 x 16	16 x 16 x 16
220	8 x 8 x 10	10 x 10 x 10	10 x 10 x 12	12.5 x 12.5 x 13	12.5 x 12.5 x 16	16 x 16 x 16	16 x 16 x 21 18 x 18 x 16
330	10 x 10 x 10	10 x 10 x 12	12.5 x 12.5 x 13	12.5 x 12.5 x 16	16 x 16 x 16	16 x 16 x 21 18 x 18 x 16	18 x 18 x 21
470	10 x 10 x 12	12.5 x 12.5 x 13	12.5 x 12.5 x 16	16 x 16 x 16	16 x 16 x 16	18 x 18 x 21	-
680	12.5 x 12.5 x 13	12.5 x 12.5 x 16	16 x 16 x 16	16 x 16 x 16	18 x 18 x 16	-	-
820	→	→	→	→	16 x 16 x 21	-	-
1000	12.5 x 12.5 x 16	16 x 16 x 16	16 x 16 x 16	16 x 16 x 21 18 x 18 x 16	18 x 18 x 21	-	-
1200	→	→	18 x 18 x 16	18 x 18 x 21	-	-	-
1500	16 x 16 x 16	16 x 16 x 16	16 x 16 x 21	-	-	-	-
1800	→	→	18 x 18 x 21	-	-	-	-
2200	16 x 16 x 16	16 x 16 x 21 18 x 18 x 16	-	-	-	-	-
2700	→	18 x 18 x 21	-	-	-	-	-
3300	16 x 16 x 21 18 x 18 x 16	-	-	-	-	-	-
3900	18 x 18 x 21	-	-	-	-	-	-
4700	18 x 18 x 21	-	-	-	-	-	-

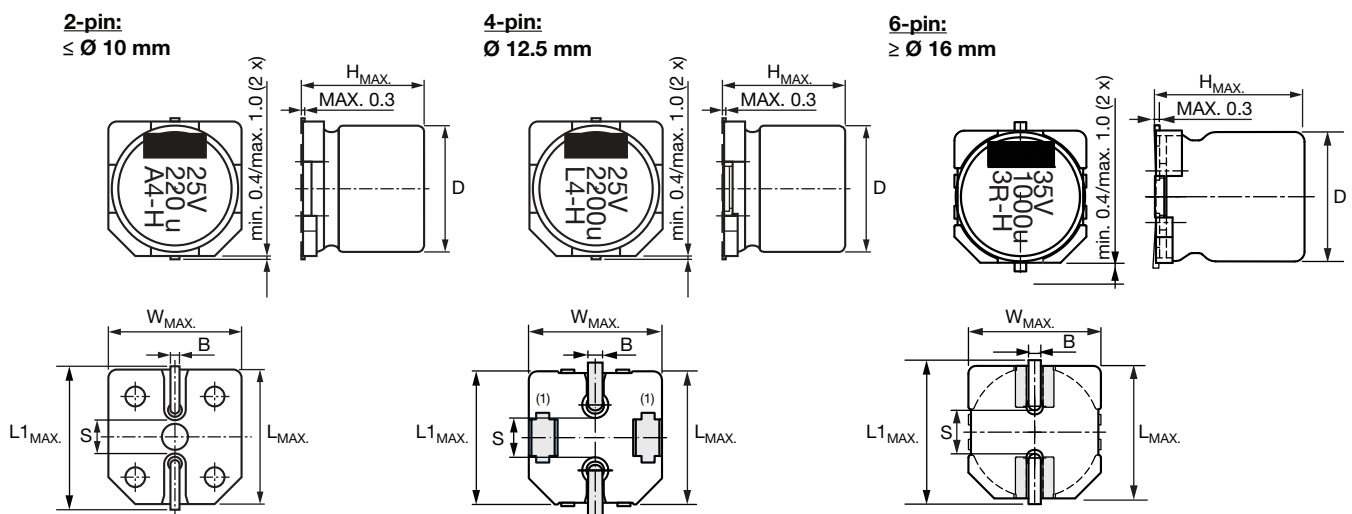

Fig. 2 - Dimensional outline

**Note**

(1) Additional dummy pins for mechanical stability, no electrical connection to pins or can



Fig. 3 - Coplanarity of pins

**Table 1**

<b>DIMENSIONS</b> in millimeters <b>AND MASS</b>									
NOMINAL CASE SIZE L x W x H	CASE CODE	L <sub>MAX.</sub>	W <sub>MAX.</sub>	H <sub>MAX.</sub>	Ø D	B <sub>MAX.</sub>	S	L1 <sub>MAX.</sub>	MASS (g)
8 x 8 x 10	0810	8.5	8.5	10.5	8.0	1.0	2.2	10.2	≈ 1.0
10 x 10 x 10	1010	10.5	10.5	10.5	10.0	1.0	3.5	12.1	≈ 1.3
10 x 10 x 12	1012	10.5	10.5	12.5	10.0	1.0	3.5	12.1	≈ 1.5
12.5 x 12.5 x 13	1213	12.9	12.9	14.0	12.5	1.3	3.6	14.9	≈ 2.6
12.5 x 12.5 x 16	1216	12.9	12.9	16.5	12.5	1.3	3.6	14.9	≈ 2.8
16 x 16 x 16	1616	16.6	16.6	17.5	16.0	1.3	6.5	18.6	≈ 5.5
16 x 16 x 21	1621	16.6	16.6	22.0	16.0	1.3	6.5	18.6	≈ 6.0
18 x 18 x 16	1816	19.0	19.0	17.5	18.0	1.3	6.5	21.0	≈ 8.0
18 x 18 x 21	1821	19.0	19.0	22.0	18.0	1.3	6.5	21.0	≈ 8.3

**Table 2**

<b>TAPE AND REEL DIMENSIONS</b> in millimeters, <b>PACKAGING QUANTITIES</b>						
NOMINAL CASE SIZE L x W x H	CASE CODE	PITCH P <sub>1</sub>	TAPE WIDTH W	TAPE THICKNESS T <sub>2</sub>	REEL DIAMETER	PACKAGING QUANTITY PER REEL
8 x 8 x 10	0810	16	24	11.6	380	500
10 x 10 x 10	1010	16	24	11.6	380	500
10 x 10 x 12	1012	16	24	12.8	330	250
12.5 x 12.5 x 13	1213	20	24	16.2	380	250
12.5 x 12.5 x 16	1216	24	32	18.5	380	200
16 x 16 x 16	1616	28	44	18.9	380	150
16 x 16 x 21	1621	28	44	23.4	380	100
18 x 18 x 16	1816	32	44	18.9	380	125
18 x 18 x 21	1821	32	44	23.4	380	100

**Note**

- Detailed tape dimensions see section “PACKAGING”

**MOUNTING**

The capacitors are designed for automatic placement on to printed-circuit boards.

Optimum dimensions of soldering pads depend amongst others on soldering method, mounting accuracy, print layout and / or adjacent components.

For recommended soldering pad dimensions, refer to Fig. 4 and Table 3.

**SOLDERING**

Soldering conditions are defined by the curve, temperature versus time, where the temperature is that measured on the component during processing.

For maximum conditions refer to Fig. 5.

Any temperature versus time curve which does not exceed the specified maximum curves may be applied.

As a general principle, temperature and duration shall be the **minimum** necessary required to ensure good soldering connections. However, the specified maximum curves should never be exceeded.

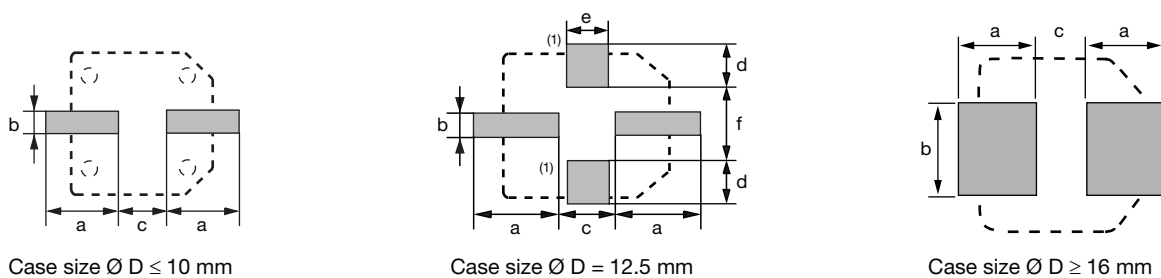

Fig. 4 - Recommended soldering pad dimensions

**Note**

(1) Additional solder pads, can be connected to GND or open

**Table 3**

<b>RECOMMENDED SOLDERING PAD DIMENSIONS</b> in millimeters						
<b>CASE CODE</b>	<b>a</b>	<b>b</b>	<b>c</b>	<b>d</b>	<b>e</b>	<b>f</b>
0810	4.4	2.5	3.0	-	-	-
1010	4.4	2.5	4.0	-	-	-
1012	4.4	2.5	4.0	-	-	-
1213	6.3	2.5	4.0	4.2	5.0	5.6
1216	6.3	2.5	4.0	4.2	5.0	5.6
1616	7.8	9.6	4.7	-	-	-
1621	7.8	9.6	4.7	-	-	-
1816	8.8	9.6	4.7	-	-	-
1821	8.8	9.6	4.7	-	-	-

**ADVANCED SOLDERING PROFILE FOR LEAD (Pb)-FREE REFLOW PROCESS  
ACCORDING TO JEDEC J-STD-020**

Fig. 5 - Maximum temperature load during reflow soldering

**Table 4**

<b>REFLOW SOLDERING CONDITIONS</b> for MAL214699xxxE3			
<b>PROFILE FEATURES</b>	<b>CASE CODE 0810 TO 1012</b>	<b>CASE CODE 1213 TO 1216</b>	<b>CASE CODE 1616 TO 1821</b>
Max. time from 25 °C to $T_{Peak}$	300 s	300 s	300 s
Max. ramp-up rate to 150 °C	3 K/s	3 K/s	3 K/s
Max. time from 150 °C to 200 °C ( $t_1$ )	150 s	150 s	150 s
Max. time from 190 °C to 200 °C ( $t_2$ )	110 s	110 s	110 s
Ramp up rate from 200 °C to $T_{Peak}$	0.5 K/s to 3 K/s	0.5 K/s to 3 K/s	0.5 K/s to 3 K/s
Max. time above $T_{Liquidus}$ (217 °C) ( $t_3$ )	90 s	90 s	90 s
Max. time above 230 °C ( $t_4$ )	70 s	65 s	60 s
Peak temperature $T_{Peak}$	260 °C	250 °C	245 °C
Max. time above $T_{Peak}$ minus 5 °C	40 s	30 s	30 s
Ramp-down rate from $T_{Liquidus}$	3 K/s to 6 K/s	3 K/s to 6 K/s	3 K/s to 6 K/s

**Notes**

- Temperature measuring point on top of the case and on terminals
- Max. 2 runs with pause of min. 30 min in between



ELECTRICAL DATA	
SYMBOL	DESCRIPTION
$C_R$	Rated capacitance at 100 Hz, tolerance $\pm 20\%$
$I_R$	Rated RMS ripple current at 100 kHz, 125 °C
$I_{L2}$	Max. leakage current after 2 min at $U_R$
$\tan \delta$	Max. dissipation factor at 100 Hz
Z	Max. impedance at 100 kHz

**Note**

- Unless otherwise specified, all electrical values in Table 5 apply at  $T_{amb} = 20\text{ °C}$ ,  $P = 86\text{ kPa}$  to  $106\text{ kPa}$ ,  $RH = 45\%$  to  $75\%$

Table 5

ELECTRICAL DATA AND ORDERING INFORMATION									
$U_R$ (V)	$C_R$ ( $\mu\text{F}$ )	NOMINAL CASE SIZE L x W x H (mm)	$I_R$ 125 °C 100 kHz (mA)	$I_{L2}$ 2 min ( $\mu\text{A}$ )	$\tan \delta$ 100 Hz	Z 100 kHz 20 °C ( $\Omega$ )	Z 100 kHz -40 °C ( $\Omega$ )	LIFE CODE <sup>(1)</sup>	ORDERING CODE MAL2146...
16	220	8 x 8 x 10	650	35	0.16	0.300	2.40	L1	99512E3
	330	10 x 10 x 10	750	53	0.16	0.150	1.35	L1	99501E3
	470	10 x 10 x 12	900	75	0.16	0.097	0.87	L2	99502E3
	680	12.5 x 12.5 x 13	1100	109	0.16	0.075	0.68	L4	99503E3
	1000	12.5 x 12.5 x 16	1300	160	0.16	0.058	0.52	L5	99504E3
	1500	16 x 16 x 16	1400	240	0.16	0.050	0.45	L6	99505E3
	2200	16 x 16 x 16	1400	352	0.18	0.050	0.45	L6	99506E3
	3300	16 x 16 x 21	1660	528	0.20	0.035	0.32	L7	99507E3
	3300	18 x 18 x 16	1500	528	0.20	0.050	0.45	L6	99508E3
	3900	18 x 18 x 21	1750	624	0.20	0.035	0.32	L7	99509E3
4700	18 x 18 x 21	1750	752	0.22	0.035	0.32	L7	99511E3	
25	100	8 x 8 x 10	650	25	0.14	0.300	2.40	L1	99611E3
	220	10 x 10 x 10	750	55	0.14	0.150	1.35	L1	99601E3
	330	10 x 10 x 12	900	83	0.14	0.097	0.87	L2	99602E3
	470	12.5 x 12.5 x 13	1100	118	0.14	0.075	0.68	L4	99603E3
	680	12.5 x 12.5 x 16	1300	170	0.14	0.058	0.52	L5	99604E3
	1000	16 x 16 x 16	1400	250	0.14	0.050	0.45	L6	99605E3
	1500	16 x 16 x 16	1400	375	0.14	0.050	0.45	L6	99606E3
	2200	16 x 16 x 21	1660	550	0.16	0.035	0.32	L7	99607E3
	2200	18 x 18 x 16	1500	550	0.16	0.050	0.45	L6	99608E3
	2700	18 x 18 x 21	1750	675	0.16	0.035	0.32	L7	99609E3
35	33	8 x 8 x 10	650	12	0.12	0.300	2.40	L1	99013E3
	47	10 x 10 x 10	750	17	0.12	0.150	1.35	L1	99001E3
	100	10 x 10 x 10	750	35	0.12	0.150	1.35	L1	99002E3
	150	10 x 10 x 10	750	53	0.12	0.150	1.35	L1	99003E3
	220	10 x 10 x 12	900	77	0.12	0.097	0.87	L2	99004E3
	330	12.5 x 12.5 x 13	1100	116	0.12	0.075	0.68	L4	99005E3
	470	12.5 x 12.5 x 16	1300	165	0.12	0.058	0.52	L5	99006E3
	680	16 x 16 x 16	1400	238	0.12	0.050	0.45	L6	99007E3
	1000	16 x 16 x 16	1400	350	0.12	0.050	0.45	L6	99008E3
	1200	18 x 18 x 16	1500	420	0.12	0.050	0.45	L6	99009E3
	1500	16 x 16 x 21	1660	525	0.12	0.035	0.32	L7	99011E3
	1800	18 x 18 x 21	1750	630	0.12	0.035	0.32	L7	99012E3
50	47	10 x 10 x 10	600	24	0.10	0.240	2.16	L1	99101E3
	68	10 x 10 x 10	600	34	0.10	0.240	2.16	L1	99102E3
	100	10 x 10 x 10	600	50	0.10	0.240	2.16	L1	99103E3
	100	10 x 10 x 12	700	50	0.10	0.170	1.53	L2	99104E3
	150	10 x 10 x 12	700	75	0.10	0.170	1.53	L2	99105E3
	220	12.5 x 12.5 x 13	900	110	0.10	0.120	1.08	L4	99106E3
	330	12.5 x 12.5 x 16	1100	165	0.10	0.085	0.76	L5	99107E3
	470	16 x 16 x 16	1300	235	0.10	0.072	0.65	L6	99108E3
	680	16 x 16 x 16	1300	340	0.10	0.072	0.65	L6	99109E3
	1000	16 x 16 x 21	1500	500	0.10	0.052	0.47	L7	99111E3
	1000	18 x 18 x 16	1300	500	0.10	0.070	0.63	L6	99112E3
	1200	18 x 18 x 21	1600	600	0.10	0.049	0.44	L7	99113E3



ELECTRICAL DATA AND ORDERING INFORMATION									
U <sub>R</sub> (V)	C <sub>R</sub> (μF)	NOMINAL CASE SIZE L x W x H (mm)	I <sub>R</sub> 125 °C 100 kHz (mA)	I <sub>L2</sub> 2 min (μA)	tan δ 100 Hz	Z 100 kHz 20 °C (Ω)	Z 100 kHz -40 °C (Ω)	LIFE CODE <sup>(1)</sup>	ORDERING CODE MAL2146...
63	22	10 x 10 x 10	400	14	0.10	0.430	3.90	L1	99801E3
	33	10 x 10 x 10	470	21	0.10	0.380	3.40	L1	99802E3
	47	10 x 10 x 10	470	30	0.10	0.380	3.40	L1	99803E3
	68	10 x 10 x 10	470	43	0.10	0.380	3.40	L1	99804E3
	100	10 x 10 x 12	550	63	0.10	0.290	2.61	L2	99805E3
	100	12.5 x 12.5 x 13	650	63	0.10	0.210	1.89	L4	99806E3
	150	12.5 x 12.5 x 13	650	95	0.10	0.210	1.89	L4	99807E3
	220	12.5 x 12.5 x 16	800	139	0.10	0.160	1.44	L5	99808E3
	330	16 x 16 x 16	1050	208	0.10	0.100	0.90	L6	99809E3
	470	16 x 16 x 16	1050	296	0.10	0.100	0.90	L6	99811E3
	680	18 x 18 x 16	1150	428	0.10	0.095	0.86	L6	99812E3
820	16 x 16 x 21	1300	517	0.10	0.075	0.68	L7	99813E3	
1000	18 x 18 x 21	1400	630	0.10	0.072	0.65	L7	99814E3	
80	10	10 x 10 x 10	240	8	0.12	0.800	6.40	L2	99701E3
	22	10 x 10 x 10	240	18	0.12	0.800	6.40	L2	99702E3
	33	10 x 10 x 10	240	26	0.12	0.800	6.40	L2	99703E3
	47	10 x 10 x 12	270	38	0.12	0.620	4.96	L2	99704E3
	68	10 x 10 x 12	270	54	0.12	0.620	4.96	L2	99705E3
	100	12.5 x 12.5 x 13	580	80	0.12	0.350	2.80	L3	99706E3
	150	12.5 x 12.5 x 16	630	120	0.12	0.250	2.00	L3	99707E3
	220	16 x 16 x 16	900	176	0.12	0.180	1.44	L3	99708E3
	330	16 x 16 x 21	1100	264	0.12	0.120	0.96	L3	99709E3
	330	18 x 18 x 16	900	264	0.12	0.160	1.28	L3	99711E3
470	18 x 18 x 21	1100	376	0.12	0.110	0.88	L3	99712E3	
100	10	10 x 10 x 10	200	10	0.12	1.200	9.50	L2	99901E3
	22	10 x 10 x 10	200	22	0.12	1.200	9.50	L2	99902E3
	33	10 x 10 x 12	230	33	0.12	0.930	7.40	L2	99903E3
	47	10 x 10 x 12	230	47	0.12	0.930	7.40	L2	99904E3
	68	12.5 x 12.5 x 13	390	68	0.12	0.650	5.20	L3	99905E3
	100	12.5 x 12.5 x 16	420	100	0.12	0.500	4.00	L3	99906E3
	150	16 x 16 x 16	650	150	0.12	0.300	2.40	L3	99907E3
	220	16 x 16 x 21	810	220	0.12	0.230	1.80	L3	99908E3
	220	18 x 18 x 16	650	220	0.12	0.300	2.40	L3	99909E3
	330	18 x 18 x 21	810	330	0.12	0.230	1.80	L3	99911E3

**Note**

(1) Determines the applicable row in the table “Endurance Test Duration and Useful Life”

**Table 6**

ADDITIONAL ELECTRICAL DATA		
PARAMETER	CONDITIONS	VALUE
<b>Voltage</b>		
Surge voltage for short periods	IEC 60384-18, subclause 4.14	$U_S \leq 1.15 \times U_R$
Reverse voltage for short periods	IEC 60384-18, subclause 4.16; $T_A \leq 105 \text{ °C}$	$U_{rev} \leq 1 \text{ V}$
<b>Current</b>		
Leakage current	After 2 min at $U_R$	$I_{L2} \leq 0.01 \times C_R \times U_R$
<b>Inductance</b>		
Equivalent series inductance (ESL)	$\varnothing D = 8 \text{ mm}$	Typ. 6 nH
	$\varnothing D = 10 \text{ mm}$	Typ. 8 nH
	$\varnothing D \geq 12.5 \text{ mm}$	Typ. 11 nH
<b>Resistance</b>		
Equivalent series resistance (ESR) at 100 Hz	Calculated from $\tan \delta_{max}$ and $C_R$ (see Table 5)	$ESR = \tan \delta / 2\pi f C_R$

**CAPACITANCE (C)**

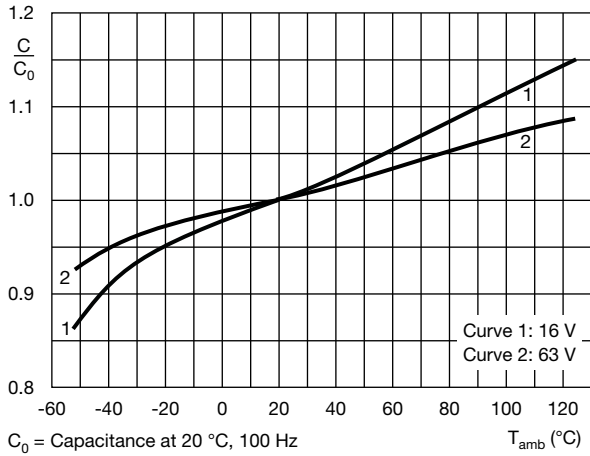

Fig. 6 - Typical multiplier of capacitance as a function of ambient temperature

**DISSIPATION FACTOR ( $\tan \delta$ )**

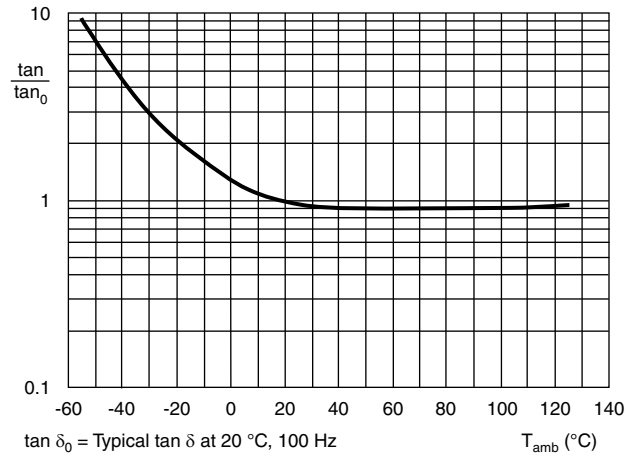

Fig. 7 - Typical multiplier of dissipation factor ( $\tan \delta$ ) as a function of ambient temperature

**EQUIVALENT SERIES RESISTANCE (ESR)**

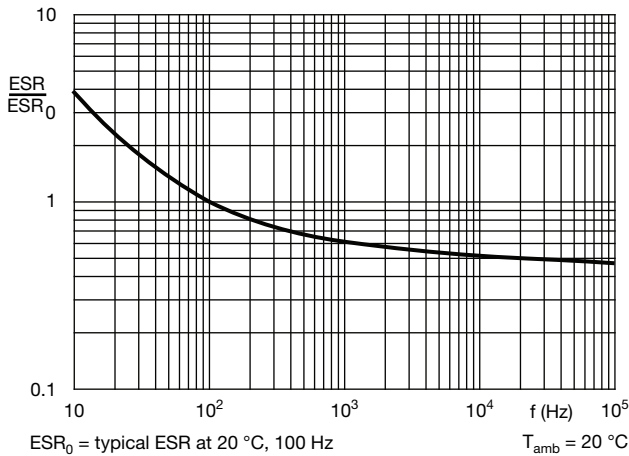

Fig. 8 - Typical multiplier of ESR as a function of frequency

**IMPEDANCE (Z)**

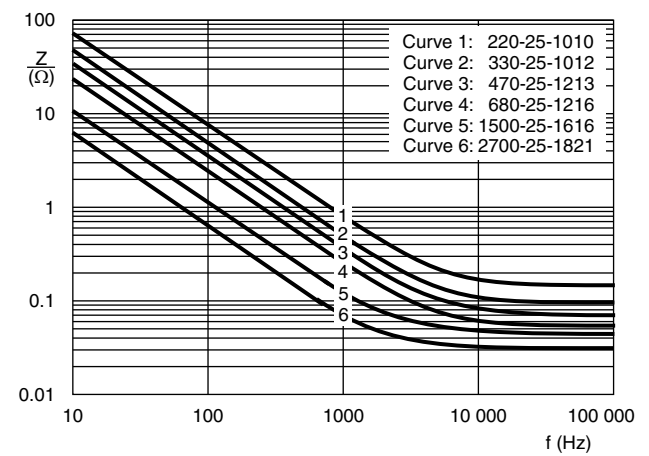

Fig. 9 - Typical impedance as a function of frequency

**IMPEDANCE (Z)**

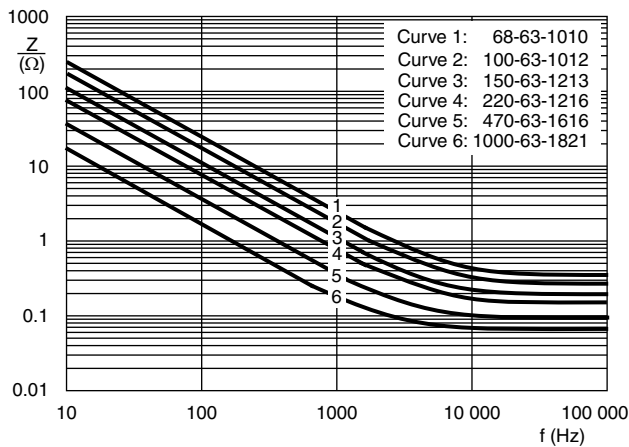

Fig. 10 - Typical impedance as a function of frequency

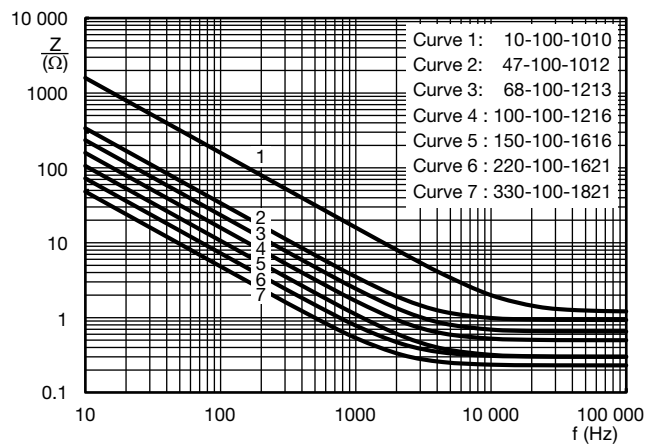

Fig. 11 - Typical impedance as a function of frequency



**RIPPLE CURRENT AND USEFUL LIFE**

Table 7

ENDURANCE TEST DURATION AND USEFUL LIFE			
LIFE CODE	ENDURANCE AT 125 °C (h)	USEFUL LIFE AT 125 °C (h)	USEFUL LIFE AT 40 °C 1.8 x I <sub>R</sub> APPLIED (h)
L1	1000	1500	150 000
L2	1500	2000	200 000
L3	2000	2500	250 000
L4	2500	3000	300 000
L5	3000	4000	325 000
L6	4000	5000	350 000
L7	5000	6000	400 000

**Note**

- Multiplier of useful life code: MBC242

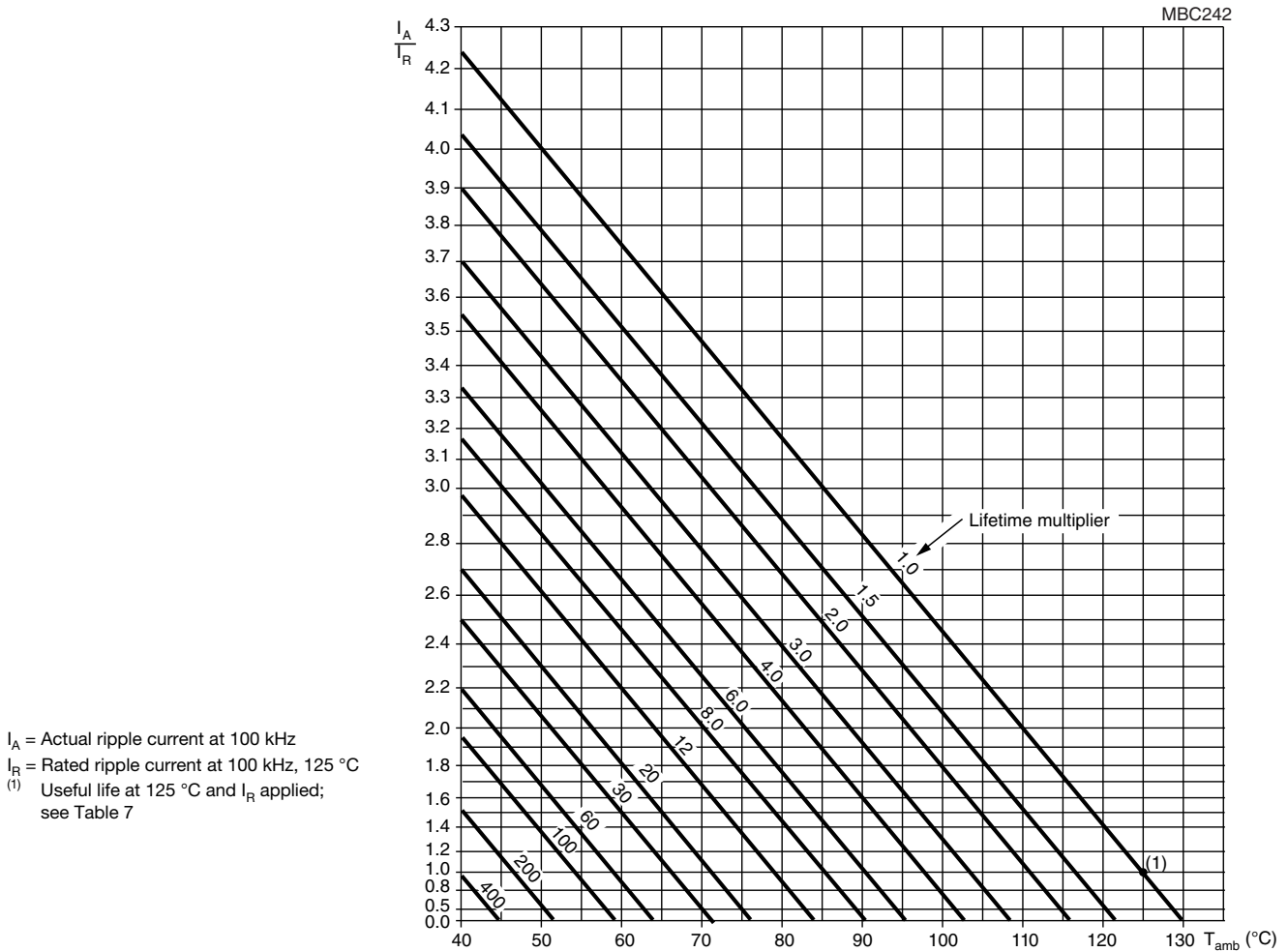

Fig. 12 - Multiplier of useful life as a function of ambient temperature and ripple current load

**Table 8**

<b>MULTIPLIER OF RIPPLE CURRENT (<math>I_R</math>) AS A FUNCTION OF FREQUENCY</b>								
$U_R$ (V)	FREQUENCY (Hz)							
	50	100	300	1000	3000	10 000	30 000	100 000
16	0.60	0.70	0.80	0.85	0.90	0.95	0.97	1.00
25	0.60	0.70	0.80	0.85	0.90	0.95	0.97	1.00
35	0.45	0.65	0.80	0.85	0.90	0.95	0.97	1.00
50	0.40	0.60	0.75	0.82	0.90	0.95	0.97	1.00
63	0.40	0.60	0.75	0.82	0.90	0.95	0.97	1.00
80	0.40	0.60	0.75	0.82	0.90	0.95	0.97	1.00
100	0.40	0.60	0.75	0.82	0.90	0.95	0.97	1.00

**Table 9**

<b>TEST PROCEDURES AND REQUIREMENTS</b>			
TEST		PROCEDURE (quick reference)	REQUIREMENTS
NAME OF TEST	REFERENCE		
Mounting	IEC 60384-18, subclause 4.3	Shall be performed prior to tests mentioned below; reflow soldering; for maximum temperature load refer to chapter "Mounting"	$\Delta C/C: \pm 5 \%$ $\tan \delta \leq \text{spec. limit}$ $I_{L2} \leq \text{spec. limit}$
Endurance	IEC 60384-18 / CECC 32300, subclause 4.15	$T_{\text{amb}} = 125 \text{ }^\circ\text{C}$ ; $U_R$ applied; for test duration see Table 7	$U_R \geq 16 \text{ V}$ ; $\Delta C/C: \pm 20 \%$ $\tan \delta \leq 2 \times \text{spec. limit}$ $I_{L2} \leq \text{spec. limit}$
Useful life	CECC 30301, subclause 1.8.1	$T_{\text{amb}} = 125 \text{ }^\circ\text{C}$ ; $U_R$ and $I_R$ applied; for test duration see Table 7	$\Delta C/C: \pm 30 \%$ $\tan \delta \leq 3 \times \text{spec. limit}$ $I_{L2} \leq \text{spec. limit}$ no short or open circuit total failure percentage: $\leq 1 \%$
Shelf life (storage at high temperature)	IEC 60384-18 / CECC 32300, subclause 4.17	$T_{\text{amb}} = 125 \text{ }^\circ\text{C}$ ; no voltage applied; 1000 h after test: $U_R$ to be applied for 30 min, 24 h to 48 h before measurement	For requirements see "Endurance test" above
Reverse voltage	IEC 60384-18 / CECC 32300, subclause 4.16	$T_{\text{amb}} = 125 \text{ }^\circ\text{C}$ ; 125 h at $U = -0.5 \text{ V}$ , followed by 125 h at $U_R$	$\Delta C/C: \pm 15 \%$ $\tan \delta \leq 1.5 \times \text{spec. limit}$ $I_{L2} \leq \text{spec. limit}$

Statements about product lifetime are based on calculations and internal testing. They should only be interpreted as estimations. Also due to external factors, the lifetime in the field application may deviate from the calculated lifetime. In general, nothing stated herein shall be construed as a guarantee of durability.



## Disclaimer

ALL PRODUCT, PRODUCT SPECIFICATIONS AND DATA ARE SUBJECT TO CHANGE WITHOUT NOTICE TO IMPROVE RELIABILITY, FUNCTION OR DESIGN OR OTHERWISE.

Vishay Intertechnology, Inc., its affiliates, agents, and employees, and all persons acting on its or their behalf (collectively, "Vishay"), disclaim any and all liability for any errors, inaccuracies or incompleteness contained in any datasheet or in any other disclosure relating to any product.

Vishay makes no warranty, representation or guarantee regarding the suitability of the products for any particular purpose or the continuing production of any product. To the maximum extent permitted by applicable law, Vishay disclaims (i) any and all liability arising out of the application or use of any product, (ii) any and all liability, including without limitation special, consequential or incidental damages, and (iii) any and all implied warranties, including warranties of fitness for particular purpose, non-infringement and merchantability.

Statements regarding the suitability of products for certain types of applications are based on Vishay's knowledge of typical requirements that are often placed on Vishay products in generic applications. Such statements are not binding statements about the suitability of products for a particular application. It is the customer's responsibility to validate that a particular product with the properties described in the product specification is suitable for use in a particular application. Parameters provided in datasheets and / or specifications may vary in different applications and performance may vary over time. All operating parameters, including typical parameters, must be validated for each customer application by the customer's technical experts. Product specifications do not expand or otherwise modify Vishay's terms and conditions of purchase, including but not limited to the warranty expressed therein.

Hyperlinks included in this datasheet may direct users to third-party websites. These links are provided as a convenience and for informational purposes only. Inclusion of these hyperlinks does not constitute an endorsement or an approval by Vishay of any of the products, services or opinions of the corporation, organization or individual associated with the third-party website. Vishay disclaims any and all liability and bears no responsibility for the accuracy, legality or content of the third-party website or for that of subsequent links.

Except as expressly indicated in writing, Vishay products are not designed for use in medical, life-saving, or life-sustaining applications or for any other application in which the failure of the Vishay product could result in personal injury or death. Customers using or selling Vishay products not expressly indicated for use in such applications do so at their own risk. Please contact authorized Vishay personnel to obtain written terms and conditions regarding products designed for such applications.

No license, express or implied, by estoppel or otherwise, to any intellectual property rights is granted by this document or by any conduct of Vishay. Product names and markings noted herein may be trademarks of their respective owners.

## Looking for pricing, stock, or lifecycle information?

Click below to explore more details on WIN SOURCE:

 [View MAL214699006E3 on WIN SOURCE](#)

 [Vishay Information](#)

## Optimize Your Supply Chain with WIN SOURCE Solutions

-  Global Sourcing Solution
-  Obsolete Management
-  Cost Control Management
-  Shortage Management
-  Alternative Solution
-  Excess Inventory Management