



**THE DATASHEET OF  
SCF19XV-100-1R1A009JV**



# Common Mode SCF19XV, SCR19XV & SCT19XV Coils, Automotive Grade

## Overview

The KEMET SCF19XV, SCR19XV & SCT19XV coils are common mode chokes with a wide variety of characteristics for automotive and harsh environment industrial application. These toroidal coils are designed with nanocrystalline metal and Mn-Zn Ferrite cores and are useful in various noise countermeasure fields.

## Applications

- On board charger for EV/PHEV
- Wireless charging systems with 85 kHz
- Medium power drives for steering, air conditioning and mild hybrid 48 V systems
- High voltage automotive and harsh environment industrial EMI filtering

## Benefits

- Nanocrystalline metal core for SCF19XV
- Mn-Zn Ferrite S15H for SCR19XV
- Mn-Zn Ferrite 7HT for SCT19XV
- High rated voltage up to 1,000 V AC/DC
- Operating temperature range from -40°C to +150°C (SCF19XV & SCT19XV)
- Operating temperature range from -40°C to +120°C (SCR19XV)
- Ultra-high inductance for SCF19XV
- Ultra-high permeability for SCR19XV
- UL 94 V-0 flame retardant rated base and cap
- AEC-Q200 qualified

**Vertical Type**  
Smaller Footprint



**Horizontal Type**  
Lower Height



## Part Number System

SC	F	19X	V	080-		1R0	A	011	JV
Series	Core material Code	"Dimension Code (See Dimensions)"	Automotive Grade	"Rated Current (A)"	Phase	"Wire Diameter (mm)"	Windings	Number of Turns	Terminal Base Type
SC	"F = Nanocrystal core R = Mn-Zn Ferrite core S15H T = Mn-Zn Ferrite core 7HT"	19X	V = AEC-Q200 qualified	"xxx- = xx.x A Examples: 080 = 8.0 A 200 = 20.0 A"	Blank = Single-phase	"R = Decimal point Examples: 1R0 = 1.0 mm 2R4 = 2.4 mm"	A = Single	"00x = x turns 0xx = xx turns Examples: 005 = 5 turns 011 = 11 turns"	"JV = Vertical type JH = Horizontal type"

## Magnetic Permeability of Ferrite Material

In order to achieve efficient noise reduction, it is important to select the material according to the target frequency band. Depending on its magnetic permeability, a particular ferrite material or metal material will be effective in a certain frequency band. A schematic representation of the relationship between the magnetic permeability of each material and the corresponding effective band range is shown in Figure 1.

Materials with higher magnetic permeability are effective in the lower frequency range, while those with lower magnetic permeability are effective in the higher frequency range. Thus, Mn-Zn products are mainly used for reducing conduction noise, while Ni-Zn products are commonly used for radiation noise countermeasures. Metal materials, however, are effective throughout the broadband frequency range, in low as well as high frequencies.

The effective frequency range varies depending on core shape, size, and number of windings. This frequency dependence of the magnetic permeability as shown in the figure serves for reference purposes only. It should be tested on the actual device to determine its effectiveness.

S18H, S15H, 10H, 7H, 7HT, 5H, 5HT, 1400L, and 700L are KEMET's proprietary ferrite material names. Other materials are available upon request.

Figure 1 - Relationship between the magnetic permeability of each material and its effective frequency range

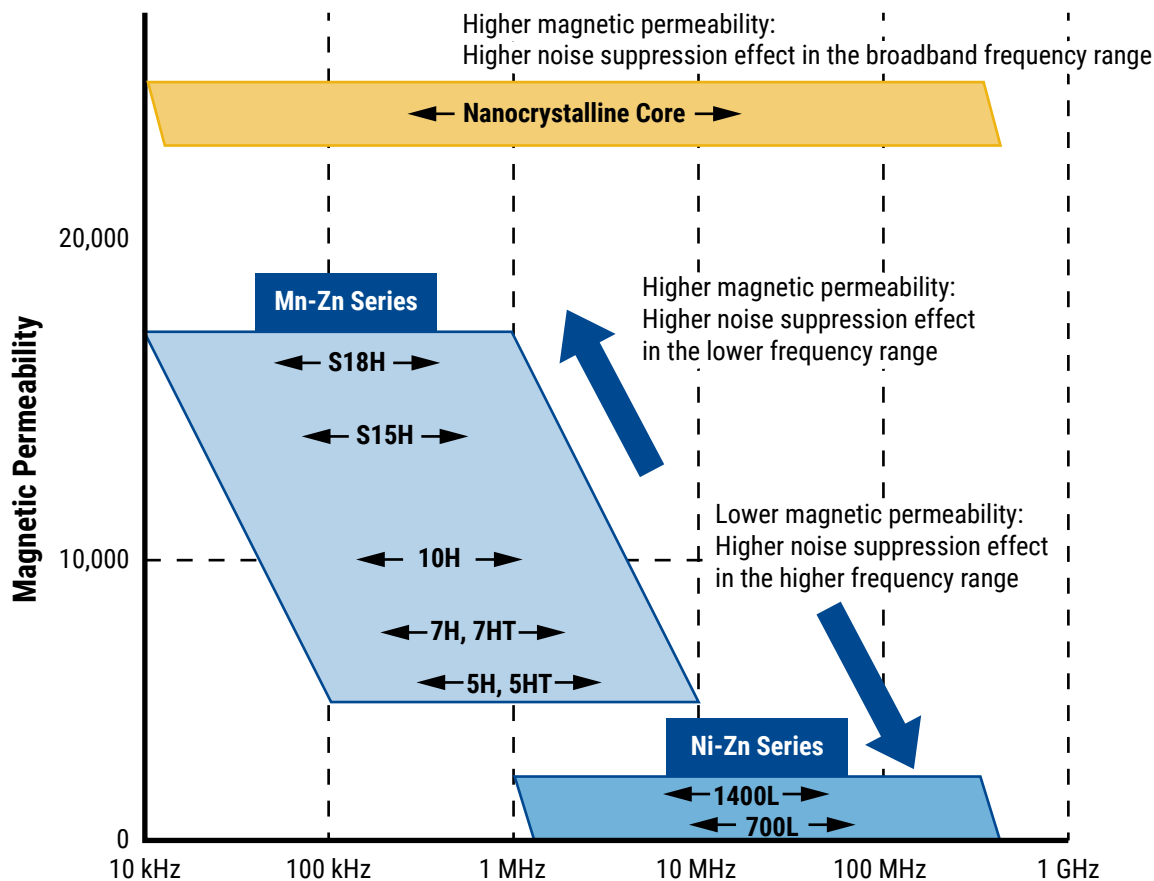

## Dimensions – Millimeters

Figure 1

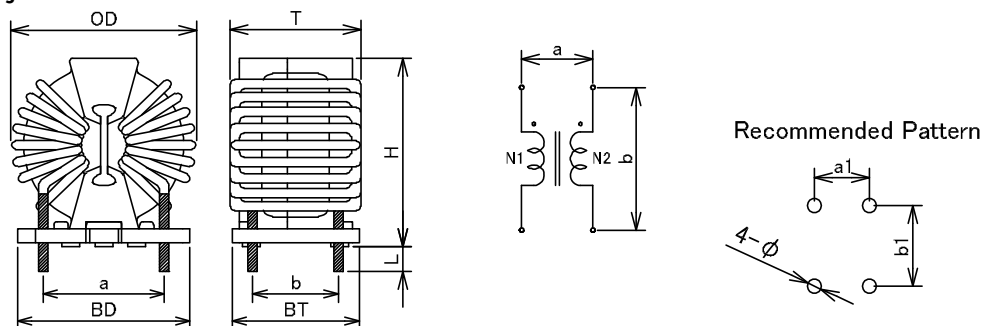
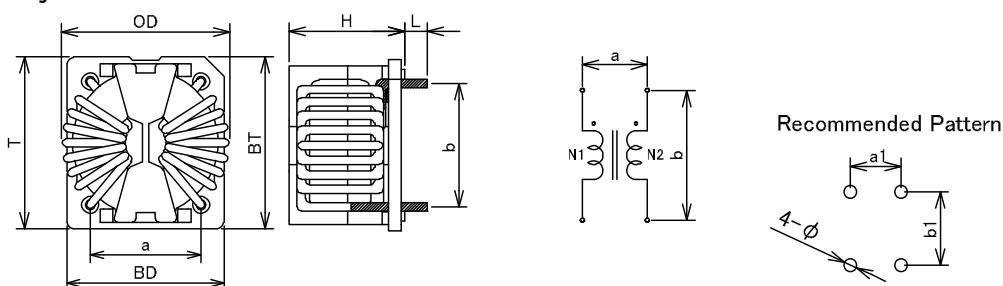

Figure 2



Part Type	Dimensions (mm)				Base Dimensions <sup>2</sup>		Pin Pitch <sup>3</sup>		Recommended Hole Pattern <sup>4</sup>			Figure
	OD (Maximum)	T (Maximum)	H <sup>1</sup>	L	BD	BT	a	b	a1	b1	φ	
SCF19XV-080-1R0A011JV	27.0	18.4	26.50 +1.0/-0.6	3.50 ±0.5	24.20 ±0.5	17.85 ±0.5	17.0 ±0.5	12.0 ±0.5	17.0	12.0	1.4	Fig. 1
SCF19XV-100-1R1A009JV	27.0	18.4	26.50 +1.0/-0.6	3.50 ±0.5	24.20 ±0.5	17.85 ±0.5	17.0 ±0.5	12.0 ±0.5	17.0	12.0	1.5	Fig. 1
SCF19XV-120-1R2A007JV	27.0	18.4	26.50 +1.0/-0.6	3.50 ±0.5	24.20 ±0.5	17.85 ±0.5	17.0 ±0.5	12.0 ±0.5	17.0	12.0	1.6	Fig. 1
SCF19XV-150-1R3A006JV	27.0	18.4	26.50 +1.0/-0.6	3.50 ±0.5	24.20 ±0.5	17.85 ±0.5	17.0 ±0.5	12.0 ±0.5	17.0	12.0	1.7	Fig. 1
SCF19XV-190-1R5A005JV	28.0	18.4	26.50 +1.0/-0.6	3.50 ±0.5	24.20 ±0.5	17.85 ±0.5	17.0 ±0.5	12.0 ±0.5	17.0	12.0	2.0	Fig. 1
SCF19XV-220-1R6A004JV	28.0	18.4	26.50 +1.0/-0.6	3.50 ±0.5	24.20 ±0.5	17.85 ±0.5	17.0 ±0.5	12.0 ±0.5	17.0	12.0	2.1	Fig. 1
SCF19XV-300-1R9A003JV	28.0	18.4	26.50 +1.0/-0.6	3.50 ±0.5	24.20 ±0.5	17.85 ±0.5	17.0 ±0.5	12.0 ±0.5	17.0	12.0	2.5	Fig. 1
SCR19XV-080-1R0A011JV	27.0	18.4	26.50 +1.0/-0.6	3.50 ±0.5	24.20 ±0.5	17.85 ±0.5	17.0 ±0.5	12.0 ±0.5	17.0	12.0	1.4	Fig. 1
SCR19XV-100-1R1A009JV	27.0	18.4	26.50 +1.0/-0.6	3.50 ±0.5	24.20 ±0.5	17.85 ±0.5	17.0 ±0.5	12.0 ±0.5	17.0	12.0	1.5	Fig. 1
SCR19XV-120-1R2A007JV	27.0	18.4	26.50 +1.0/-0.6	3.50 ±0.5	24.20 ±0.5	17.85 ±0.5	17.0 ±0.5	12.0 ±0.5	17.0	12.0	1.6	Fig. 1
SCR19XV-150-1R3A006JV	27.0	18.4	26.50 +1.0/-0.6	3.50 ±0.5	24.20 ±0.5	17.85 ±0.5	17.0 ±0.5	12.0 ±0.5	17.0	12.0	1.7	Fig. 1
SCR19XV-190-1R5A005JV	28.0	18.4	26.50 +1.0/-0.6	3.50 ±0.5	24.20 ±0.5	17.85 ±0.5	17.0 ±0.5	12.0 ±0.5	17.0	12.0	2.0	Fig. 1
SCR19XV-220-1R6A004JV	28.0	18.4	26.50 +1.0/-0.6	3.50 ±0.5	24.20 ±0.5	17.85 ±0.5	17.0 ±0.5	12.0 ±0.5	17.0	12.0	2.1	Fig. 1
SCR19XV-300-1R9A003JV	28.0	18.4	26.50 +1.0/-0.6	3.50 ±0.5	24.20 ±0.5	17.85 ±0.5	17.0 ±0.5	12.0 ±0.5	17.0	12.0	2.5	Fig. 1

<sup>1</sup> We do not inspect the lower limit dimension. (design guarantee)

<sup>2</sup> We do not inspect the terminal base dimension. (design guarantee)

<sup>3</sup> Inspection by using pin-pitch gauge.

<sup>4</sup> Implementation conditions, please confirm that there is no pre-problem.

## Dimensions – Millimeters cont.

Part Type	Dimensions (mm)				Base Dimensions <sup>2</sup>		Pin Pitch <sup>3</sup>		Recommended Hole Pattern <sup>4</sup>			Figure
	OD (Maximum)	T (Maximum)	H <sup>1</sup>	L	BD	BT	a	b	a1	b1	φ	
SCT19XV-080-1R0A011JV	27.0	18.4	26.50 +1.0/-0.6	3.50 ±0.5	24.20 ±0.5	17.85 ±0.5	17.0 ±0.5	12.0 ±0.5	17.0	12.0	1.4	Fig. 1
SCT19XV-100-1R1A009JV	27.0	18.4	26.50 +1.0/-0.6	3.50 ±0.5	24.20 ±0.5	17.85 ±0.5	17.0 ±0.5	12.0 ±0.5	17.0	12.0	1.5	Fig. 1
SCT19XV-120-1R2A007JV	27.0	18.4	26.50 +1.0/-0.6	3.50 ±0.5	24.20 ±0.5	17.85 ±0.5	17.0 ±0.5	12.0 ±0.5	17.0	12.0	1.6	Fig. 1
SCT19XV-150-1R3A006JV	27.0	18.4	26.50 +1.0/-0.6	3.50 ±0.5	24.20 ±0.5	17.85 ±0.5	17.0 ±0.5	12.0 ±0.5	17.0	12.0	1.7	Fig. 1
SCT19XV-190-1R5A005JV	28.0	18.4	26.50 +1.0/-0.6	3.50 ±0.5	24.20 ±0.5	17.85 ±0.5	17.0 ±0.5	12.0 ±0.5	17.0	12.0	2.0	Fig. 1
SCT19XV-220-1R6A004JV	28.0	18.4	26.50 +1.0/-0.6	3.50 ±0.5	24.20 ±0.5	17.85 ±0.5	17.0 ±0.5	12.0 ±0.5	17.0	12.0	2.1	Fig. 1
SCT19XV-300-1R9A003JV	28.0	18.4	26.50 +1.0/-0.6	3.50 ±0.5	24.20 ±0.5	17.85 ±0.5	17.0 ±0.5	12.0 ±0.5	17.0	12.0	2.5	Fig. 1
SCF19XV-080-1R0A011JH	27.0	27.0	17.90 +1.0/-0.6	3.50 ±0.5	24.20 ±0.5	26.45 ±0.5	17.0 ±0.5	19.0 ±0.5	17.0	19.0	1.4	Fig. 2
SCF19XV-100-1R1A009JH	27.0	27.0	17.90 +1.0/-0.6	3.50 ±0.5	24.20 ±0.5	26.45 ±0.5	17.0 ±0.5	19.0 ±0.5	17.0	19.0	1.5	Fig. 2
SCF19XV-120-1R2A007JH	27.0	27.0	17.90 +1.0/-0.6	3.50 ±0.5	24.20 ±0.5	26.45 ±0.5	17.0 ±0.5	19.0 ±0.5	17.0	19.0	1.6	Fig. 2
SCF19XV-150-1R3A006JH	27.0	27.0	17.90 +1.0/-0.6	3.50 ±0.5	24.20 ±0.5	26.45 ±0.5	17.0 ±0.5	19.0 ±0.5	17.0	19.0	1.7	Fig. 2
SCF19XV-190-1R5A005JH	28.0	27.0	17.90 +1.0/-0.6	3.50 ±0.5	24.20 ±0.5	26.45 ±0.5	17.0 ±0.5	19.0 ±0.5	17.0	19.0	2.0	Fig. 2
SCF19XV-220-1R6A004JH	28.0	27.0	17.90 +1.0/-0.6	3.50 ±0.5	24.20 ±0.5	26.45 ±0.5	17.0 ±0.5	19.0 ±0.5	17.0	19.0	2.1	Fig. 2
SCF19XV-300-1R9A003JH	28.0	27.0	17.90 +1.0/-0.6	3.50 ±0.5	24.20 ±0.5	26.45 ±0.5	17.0 ±0.5	19.0 ±0.5	17.0	19.0	2.5	Fig. 2
SCR19XV-080-1R0A011JH	27.0	27.0	17.90 +1.0/-0.6	3.50 ±0.5	24.20 ±0.5	26.45 ±0.5	17.0 ±0.5	19.0 ±0.5	17.0	19.0	1.4	Fig. 2
SCR19XV-100-1R1A009JH	27.0	27.0	17.90 +1.0/-0.6	3.50 ±0.5	24.20 ±0.5	26.45 ±0.5	17.0 ±0.5	19.0 ±0.5	17.0	19.0	1.5	Fig. 2
SCR19XV-120-1R2A007JH	27.0	27.0	17.90 +1.0/-0.6	3.50 ±0.5	24.20 ±0.5	26.45 ±0.5	17.0 ±0.5	19.0 ±0.5	17.0	19.0	1.6	Fig. 2
SCR19XV-150-1R3A006JH	27.0	27.0	17.90 +1.0/-0.6	3.50 ±0.5	24.20 ±0.5	26.45 ±0.5	17.0 ±0.5	19.0 ±0.5	17.0	19.0	1.7	Fig. 2
SCR19XV-190-1R5A005JH	28.0	27.0	17.90 +1.0/-0.6	3.50 ±0.5	24.20 ±0.5	26.45 ±0.5	17.0 ±0.5	19.0 ±0.5	17.0	19.0	2.0	Fig. 2
SCR19XV-220-1R6A004JH	28.0	27.0	17.90 +1.0/-0.6	3.50 ±0.5	24.20 ±0.5	26.45 ±0.5	17.0 ±0.5	19.0 ±0.5	17.0	19.0	2.1	Fig. 2
SCR19XV-300-1R9A003JH	28.0	27.0	17.90 +1.0/-0.6	3.50 ±0.5	24.20 ±0.5	26.45 ±0.5	17.0 ±0.5	19.0 ±0.5	17.0	19.0	2.5	Fig. 2
SCT19XV-080-1R0A011JH	27.0	27.0	17.90 +1.0/-0.6	3.50 ±0.5	24.20 ±0.5	26.45 ±0.5	17.0 ±0.5	19.0 ±0.5	17.0	19.0	1.4	Fig. 2
SCT19XV-100-1R1A009JH	27.0	27.0	17.90 +1.0/-0.6	3.50 ±0.5	24.20 ±0.5	26.45 ±0.5	17.0 ±0.5	19.0 ±0.5	17.0	19.0	1.5	Fig. 2
SCT19XV-120-1R2A007JH	27.0	27.0	17.90 +1.0/-0.6	3.50 ±0.5	24.20 ±0.5	26.45 ±0.5	17.0 ±0.5	19.0 ±0.5	17.0	19.0	1.6	Fig. 2
SCT19XV-150-1R3A006JH	27.0	27.0	17.90 +1.0/-0.6	3.50 ±0.5	24.20 ±0.5	26.45 ±0.5	17.0 ±0.5	19.0 ±0.5	17.0	19.0	1.7	Fig. 2
SCT19XV-190-1R5A005JH	28.0	27.0	17.90 +1.0/-0.6	3.50 ±0.5	24.20 ±0.5	26.45 ±0.5	17.0 ±0.5	19.0 ±0.5	17.0	19.0	2.0	Fig. 2
SCT19XV-220-1R6A004JH	28.0	27.0	17.90 +1.0/-0.6	3.50 ±0.5	24.20 ±0.5	26.45 ±0.5	17.0 ±0.5	19.0 ±0.5	17.0	19.0	2.1	Fig. 2
SCT19XV-300-1R9A003JH	28.0	27.0	17.90 +1.0/-0.6	3.50 ±0.5	24.20 ±0.5	26.45 ±0.5	17.0 ±0.5	19.0 ±0.5	17.0	19.0	2.5	Fig. 2

<sup>1</sup> We do not inspect the lower limit dimension. (design guarantee)

<sup>2</sup> We do not inspect the terminal base dimension. (design guarantee)

<sup>3</sup> Inspection by using pin-pitch gauge.

<sup>4</sup> Implementation conditions, please confirm that there is no pre-problem.

## Environmental Compliance

All KEMET AC line filters are RoHS Compliant.



## Performance Characteristics

Item	Performance Characteristics
Rated Voltage	1,000 VAC/VDC
Withstanding Voltage	2,400 VAC (2 seconds, between lines)
Insulation Resistance	> 100 MΩ at 1,000 VDC (between lines)
Rated Current Range	8 – 30 A
Rated Inductance Range	0.110 - 1.500 mH +50%, -30% for SCF19XV type 0.056 - 0.750 mH ±35% for SCR19XV type 0.033 - 0.450 mH ±30% for SCT19XV type
Inductance Measurement Condition	100 kHz
Operating Temperature Range	-40°C to +150°C (include self temperature rise) for SCF19XV & SCT19XV type -40°C to +120°C (include self temperature rise) for SCR19XV type

### Table 1 – Ratings & Part Number Reference

Part Number	Rated Voltage AC/DC (V)	Rated Current (A)	Inductance 100kHz (mH)	DC Resistance/ Line (mΩ) ±13%	Temperature Rise (K) Reference	Wire Diameter (mm)	Weight (g) Approximate
SCF19XV-080-1R0A011JV	1,000	8	1.500 +50%, -30%	8.700	45	1.0	16.3
SCF19XV-100-1R1A009JV	1,000	10	1.000 +50%, -30%	6.030	40	1.1	16.3
SCF19XV-120-1R2A007JV	1,000	12	0.600 +50%, -30%	3.990	40	1.2	16.2
SCF19XV-150-1R3A006JV	1,000	15	0.440 +50%, -30%	2.910	45	1.3	16.2
SCF19XV-190-1R5A005JV	1,000	19	0.300 +50%, -30%	1.890	45	1.5	17.0
SCF19XV-220-1R6A004JV	1,000	22	0.200 +50%, -30%	1.380	40	1.6	16.9
SCF19XV-300-1R9A003JV	1,000	30	0.110 +50%, -30%	0.747	45	1.9	17.4
SCR19XV-080-1R0A011JV	1,000	8	0.750 ±35%	8.700	45	1.0	15.9
SCR19XV-100-1R1A009JV	1,000	10	0.500 ±35%	6.030	40	1.1	16.1
SCR19XV-120-1R2A007JV	1,000	12	0.300 ±35%	3.990	40	1.2	15.8
SCR19XV-150-1R3A006JV	1,000	15	0.220 ±35%	2.910	45	1.3	15.8
SCR19XV-190-1R5A005JV	1,000	19	0.160 ±35%	1.890	45	1.5	16.6
SCR19XV-220-1R6A004JV	1,000	22	0.100 ±35%	1.380	40	1.6	16.1
SCR19XV-300-1R9A003JV	1,000	30	0.056 ±35%	0.747	45	1.9	16.8
SCT19XV-080-1R0A011JV	1,000	8	0.450 ±30%	8.700	45	1.0	16.1
SCT19XV-100-1R1A009JV	1,000	10	0.300 ±30%	6.030	40	1.1	16.1
SCT19XV-120-1R2A007JV	1,000	12	0.180 ±30%	3.990	40	1.2	15.6
SCT19XV-150-1R3A006JV	1,000	15	0.134 ±30%	2.910	45	1.3	15.7
SCT19XV-190-1R5A005JV	1,000	19	0.093 ±30%	1.890	45	1.5	16.6
SCT19XV-220-1R6A004JV	1,000	22	0.060 ±30%	1.380	40	1.6	16.1
SCT19XV-300-1R9A003JV	1,000	30	0.033 ±30%	0.747	45	1.9	16.8
SCF19XV-080-1R0A011JH	1,000	8	1.500 +50%, -30%	8.980	45	1.0	17.2
SCF19XV-100-1R1A009JH	1,000	10	1.000 +50%, -30%	6.230	40	1.1	16.8
SCF19XV-120-1R2A007JH	1,000	12	0.600 +50%, -30%	4.190	40	1.2	16.9
SCF19XV-150-1R3A006JH	1,000	15	0.440 +50%, -30%	3.010	45	1.3	16.8
SCF19XV-190-1R5A005JH	1,000	19	0.300 +50%, -30%	1.950	45	1.5	17.8
SCF19XV-220-1R6A004JH	1,000	22	0.200 +50%, -30%	1.430	40	1.6	17.1
SCF19XV-300-1R9A003JH	1,000	30	0.110 +50%, -30%	0.767	45	1.9	18.5
Part Number	Rated Voltage AC/DC (V)	Rated Current (A)	Inductance 100kHz (mH)	DC Resistance/Line (mΩ) ±13%	Temperature Rise (K) Reference	Wire Diameter (mm)	Weight (g) Approximate

**Table 1 – Ratings & Part Number Reference cont.**

Part Number	Rated Voltage AC/DC (V)	Rated Current (A)	Inductance 100kHz (mH)	DC Resistance/ Line (mΩ) ±13%	Temperature Rise (K) Reference	Wire Diameter (mm)	Weight (g) Approximate
SCR19XV-080-1R0A011JH	1,000	8	0.750 ±35%	8.980	45	1.0	16.4
SCR19XV-100-1R1A009JH	1,000	10	0.500 ±35%	6.230	40	1.1	16.6
SCR19XV-120-1R2A007JH	1,000	12	0.300 ±35%	4.190	40	1.2	16.3
SCR19XV-150-1R3A006JH	1,000	15	0.220 ±35%	3.010	45	1.3	16.2
SCR19XV-190-1R5A005JH	1,000	19	0.160 ±35%	1.950	45	1.5	17.1
SCR19XV-220-1R6A004JH	1,000	22	0.100 ±35%	1.430	40	1.6	16.7
SCR19XV-300-1R9A003JH	1,000	30	0.056 ±35%	0.767	45	1.9	17.6
SCT19XV-080-1R0A011JH	1,000	8	0.450 ±30%	8.980	45	1.0	16.4
SCT19XV-100-1R1A009JH	1,000	10	0.300 ±30%	6.230	40	1.1	16.7
SCT19XV-120-1R2A007JH	1,000	12	0.180 ±30%	4.190	40	1.2	16.5
SCT19XV-150-1R3A006JH	1,000	15	0.134 ±30%	3.010	45	1.3	16.3
SCT19XV-190-1R5A005JH	1,000	19	0.093 ±30%	1.950	45	1.5	17.2
SCT19XV-220-1R6A004JH	1,000	22	0.060 ±30%	1.430	40	1.6	16.7
SCT19XV-300-1R9A003JH	1,000	30	0.033 ±30%	0.767	45	1.9	17.6
Part Number	Rated Voltage AC/DC (V)	Rated Current (A)	Inductance 100kHz (mH)	DC Resistance/Line (mΩ) ±13%	Temperature Rise (K) Reference	Wire Diameter (mm)	Weight (g) Approximate

## Frequency Characteristics

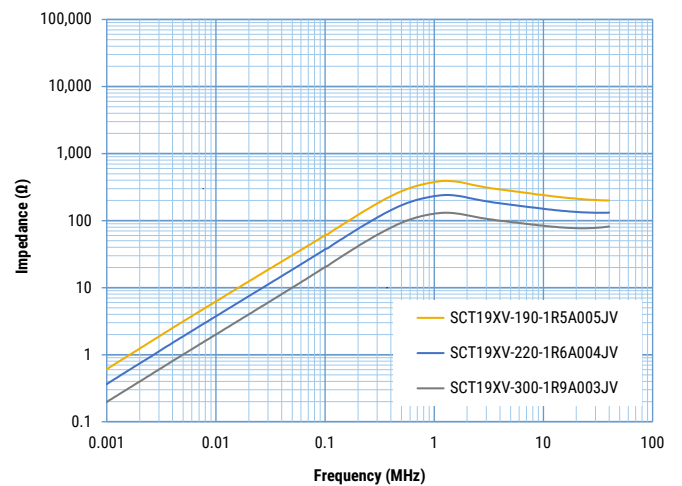
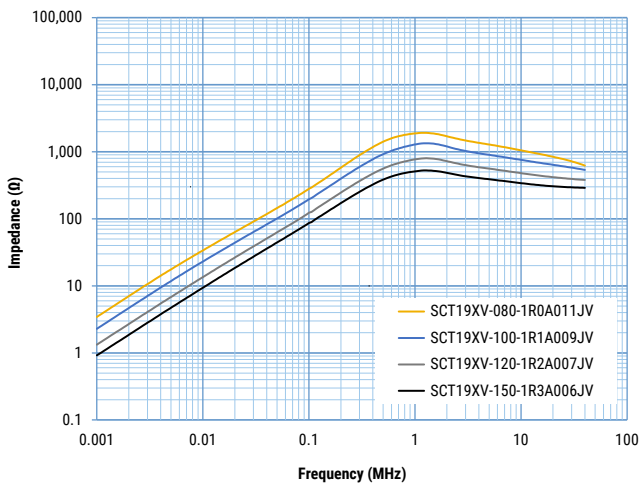
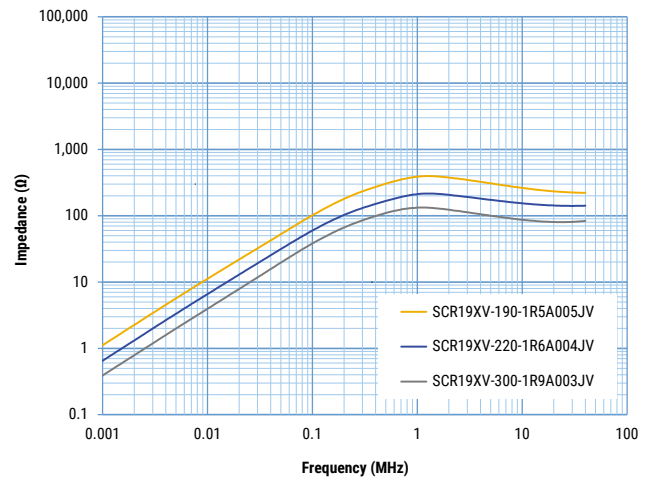
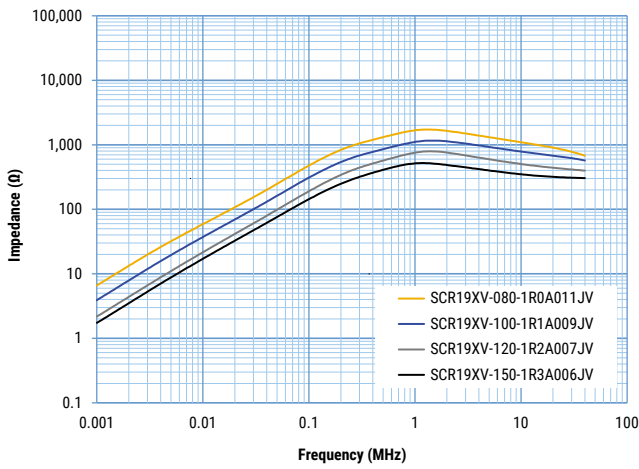
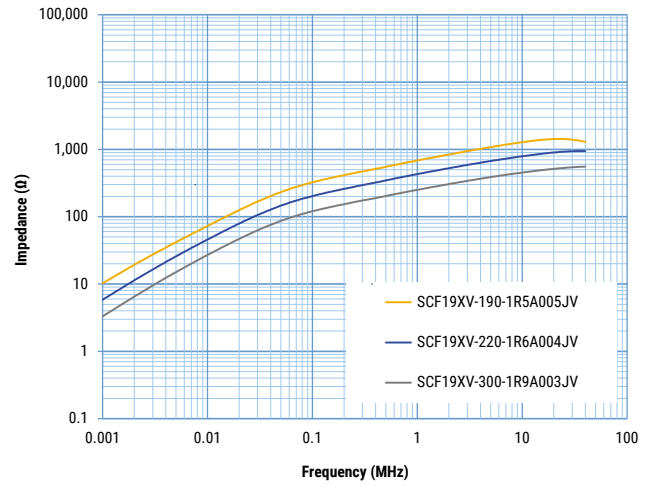
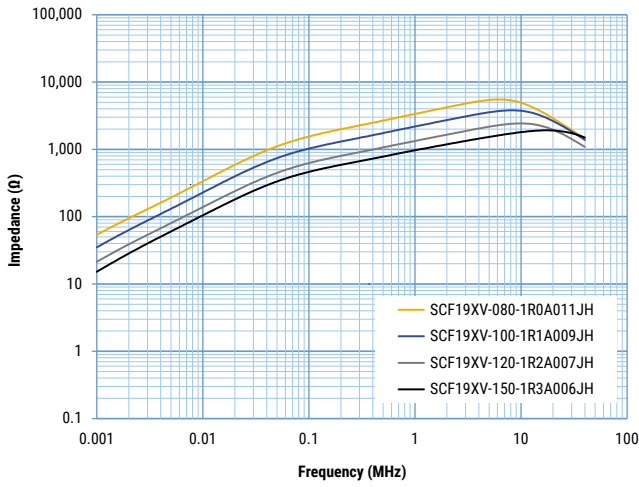

## Frequency Characteristics cont.

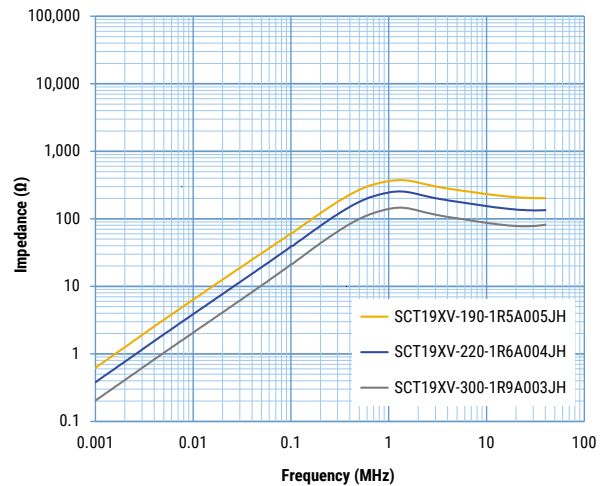
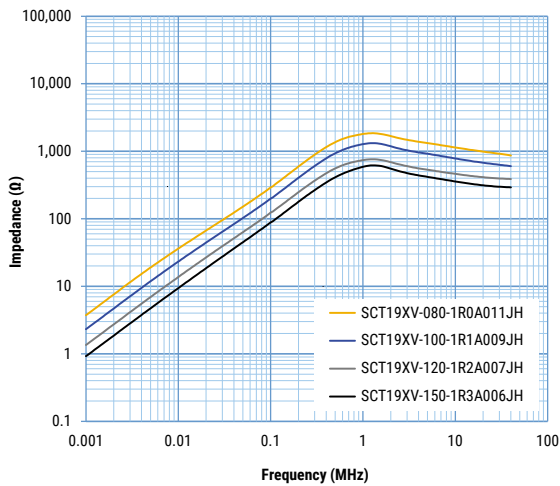
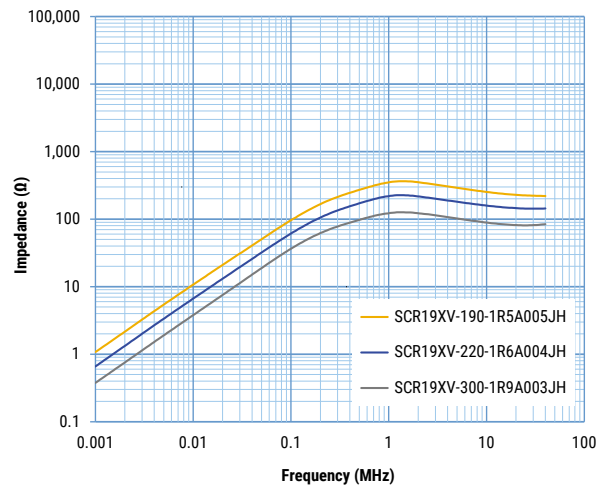
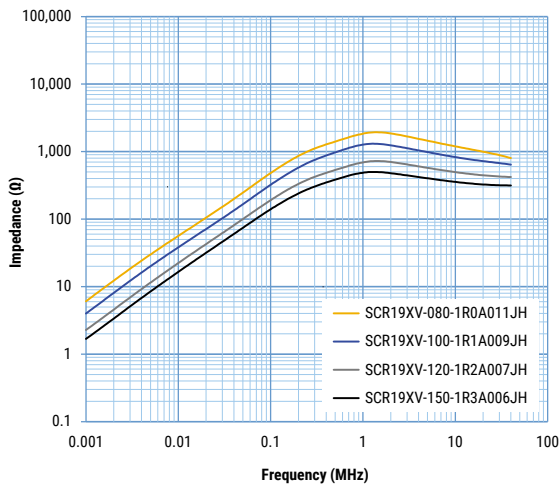
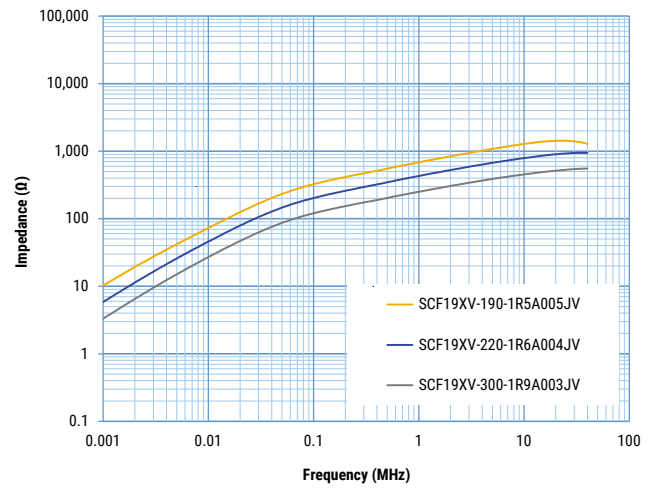
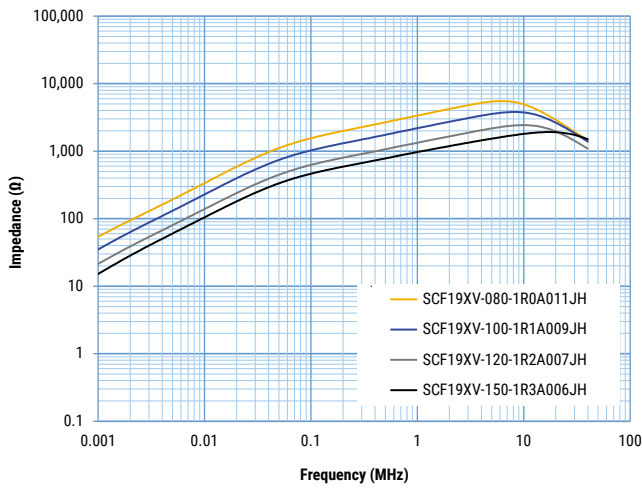

## Packaging

Type	Packaging Type	Pieces Per Box
SCF19XV-JV	Tray	210
SCR19XV-JV		
SCT19XV-JV		
SCF19XV-JH		150
SCR19XV-JH		
SCT19XV-JH		

## Recommend Solder Condition

Soldering method	Temperature	Soldering time	Number of times
Solder iron	400°C Max.	3sec. Max.	2 times
Dip soldering	260°C Max.	3sec. Max.	2 times
Flow soldering	see below	see below	see below

### Flow Soldering Condition

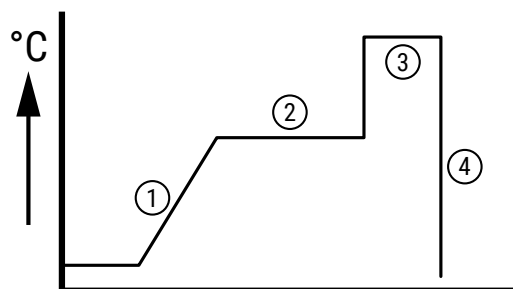

- ① Reserve Temperature
- ② Preheat Temperature: 80~110°C Time: 120 seconds
- ③ Soak Temperature: 250°C Time: 8 seconds
- ④ Cooling

Solder conditions are for reference only and should be confirmed by the customer there is no problem.

## Temperature Rise Measuring Method

Connect the cable to the CMC by soldering and cool it to room temperature. Also, N1 and N2 are shorted. In order to prevent temperature changes due to air convections, a rated current is applied to the CMC inside the container (container size: about 550 x 450 x 300 mm).

At that time, the temperature of the inner diameter of the CMC and the ambient temperature are measured with a thermocouple and recorded with a data logger.

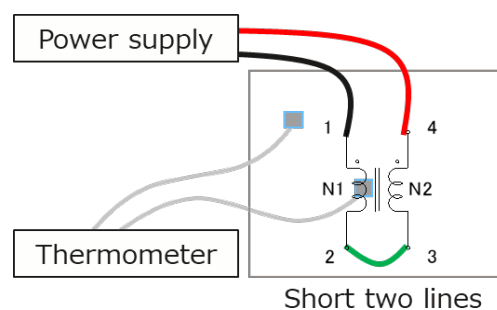
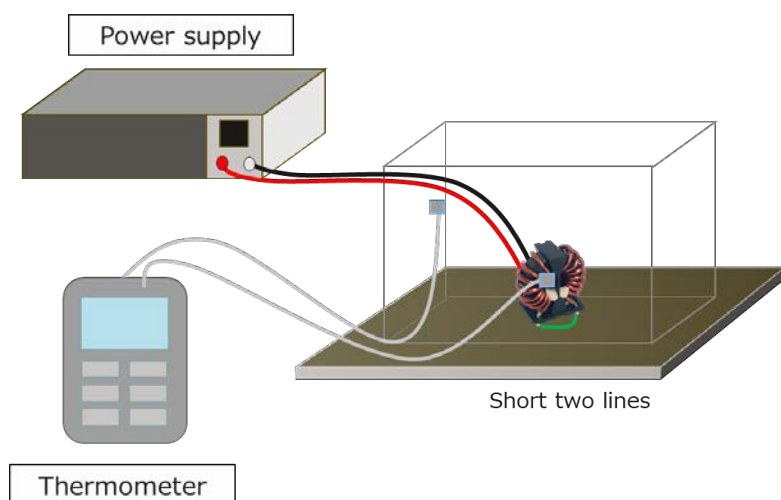

Figure 1 - Measurement system

Figure 2 - Schematics

After confirming that the temperature of the CMC has stabilized, turn off the power and calculate the temperature rise value from the measured data using the following formula.

$$T = (t_2 - t_{a2}) - (t_1 - t_{a1})$$

And then,

T : Temperature rising (°C)

t<sub>1</sub> : Initial temperature of CMC (°C)

t<sub>2</sub> : Temperature of CMC when current is applied (°C)

t<sub>a1</sub> : Initial ambient temperature (°C)

t<sub>a2</sub> : Ambient temperature when current is applied (°C)

## Handling Precautions

### Precautions for product storage

AC Line Filters should be stored in normal working environments. While the chokes themselves are quite robust in other environments, solderability will be degraded by exposure to high temperatures, high humidity, corrosive atmospheres, and long term storage.

KEMET recommends that maximum storage temperature not exceed 40°C and maximum storage humidity not exceed 70% relative humidity. Atmospheres should be free of chlorine and sulfur bearing compounds. Temperature fluctuations should be minimized to avoid condensation on the parts. Avoid storage near strong magnetic fields, as this might magnetize the product.

For optimized solderability, AC line filters stock should be used promptly and preferably within 6 months of receipt.

### Product temperature rise values

The values listed for temperature rise are the result of self-heating in wires when the rated current (commercial frequency) is applied.

When using the product, check and evaluate the value of the core temperature rise under actual operating conditions.

---

## KEMET Corporation WH

### KEMET Electronics Corporation Sales Offices

For a complete list of our global sales offices, please visit [www.kemet.com/sales](http://www.kemet.com/sales).

## KEMET Electronics Corporation Sales Offices

For a complete list of our global sales offices, please visit [www.kemet.com/sales](http://www.kemet.com/sales).

---

### Disclaimer

YAGEO Corporation and its affiliates do not recommend the use of commercial or automotive grade products for high reliability applications or manned space flight.

All product specifications, statements, information and data (collectively, the "Information") in this datasheet are subject to change. The customer is responsible for checking and verifying the extent to which the Information contained in this publication is applicable to an order at the time the order is placed. All Information given herein is believed to be accurate and reliable, but it is presented without guarantee, warranty, or responsibility of any kind, expressed or implied.

Statements of suitability for certain applications are based on KEMET Electronics Corporation's ("KEMET") knowledge of typical operating conditions for such applications, but are not intended to constitute – and KEMET specifically disclaims – any warranty concerning suitability for a specific customer application or use. The Information is intended for use only by customers who have the requisite experience and capability to determine the correct products for their application. Any technical advice inferred from this Information or otherwise provided by KEMET with reference to the use of KEMET's products is given gratis, and KEMET assumes no obligation or liability for the advice given or results obtained.

Although KEMET designs and manufactures its products to the most stringent quality and safety standards, given the current state of the art, isolated component failures may still occur. Accordingly, customer applications which require a high degree of reliability or safety should employ suitable designs or other safeguards (such as installation of protective circuitry or redundancies) in order to ensure that the failure of an electrical component does not result in a risk of personal injury or property damage.

Although all product-related warnings, cautions and notes must be observed, the customer should not assume that all safety measures are indicated or that other measures may not be required.

When providing KEMET products and technologies contained herein to other countries, the customer must abide by the procedures and provisions stipulated in all applicable export laws and regulations, including without limitation the International Traffic in Arms Regulations (ITAR), the US Export Administration Regulations (EAR) and the Japan Foreign Exchange and Foreign Trade Act.

*KEMET is a registered trademark of KEMET Electronics Corporation.*

## Looking for pricing, stock, or lifecycle information?

Click below to explore more details on WIN SOURCE:

- ⊖ [View SCF19XV-100-1R1A009JV on WIN SOURCE](#)
- ⊖ [Kemet Information](#)

## Optimize Your Supply Chain with WIN SOURCE Solutions

- ✓ Global Sourcing Solution
- ✓ Obsolete Management
- ✓ Cost Control Management
- ✓ Shortage Management
- ✓ Alternative Solution
- ✓ Excess Inventory Management