

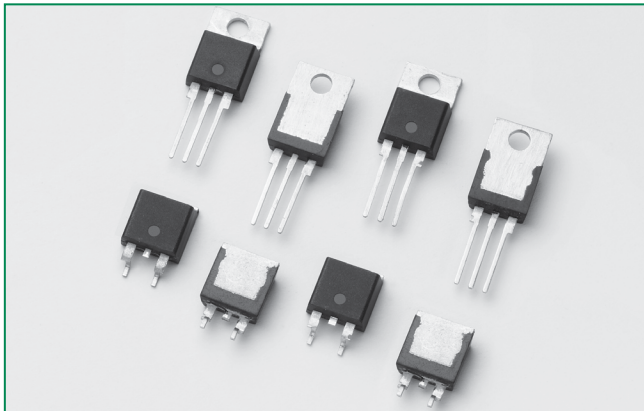

THE DATASHEET OF SK025LTP



Sxx20x & Sxx25x Series



Description

Excellent unidirectional switches for phase control applications such as heating and motor speed controls. Standard phase control SCRs are triggered with few milliamperes of current at less than 1.5V potential.

Features & Benefits

- RoHS-compliant
- Glass – passivated junctions
- Voltage capability up to 1000 V
- Surge capability up to 350 A
- Available in isolated TO-220, non-isolated TO-220 and TO-263 packages.

Agency Approval

Agency	Agency File Number
	E71639*

* - L Package Only

Applications

Typical applications are AC solid-state switches, industrial power tools, exercise equipment, white goods and commercial appliances.

Internally constructed isolated packages are offered for ease of heat sinking with highest isolation voltage.

Main Features

Symbol	Value	Unit
$I_{T(RMS)}$	20 & 25	A
V_{DRM}/V_{RRM}	400 to 1000	V
I_{GT}	30 to 35	mA

Schematic Symbol

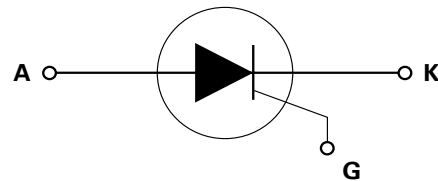

Additional Information



Datasheet



Resources



Samples

Absolute Maximum Ratings – 20A SCR

Symbol	Parameter	Test Conditions	Value	Unit
$I_{T(RMS)}$	RMS on-state current	$T_c = 80^\circ\text{C}$	20	A
$I_{T(AV)}$	Average on-state current	Sxx20x & Sxx20L $T_c = 80^\circ\text{C}$	12.8	A
I_{TSM}	Peak non-repetitive surge current	single half cycle; $f = 50\text{Hz}$; $T_J(\text{initial}) = 25^\circ\text{C}$	255	A
		single half cycle; $f = 60\text{Hz}$; $T_J(\text{initial}) = 25^\circ\text{C}$	300	
I^2t	I^2t Value for fusing	$t_p = 8.3 \text{ ms}$	374	A^2s
di/dt	Critical rate of rise of on-state current	$f = 60\text{Hz}$; $T_J = 125^\circ\text{C}$	125	$\text{A}/\mu\text{s}$
I_{GM}	Peak gate current	$T_J = 125^\circ\text{C}$	3	A
$P_{G(AV)}$	Average gate power dissipation	$T_J = 125^\circ\text{C}$	0.6	W
T_{stg}	Storage temperature range		-40 to 150	$^\circ\text{C}$
T_J	Operating junction temperature range		-40 to 125	$^\circ\text{C}$

Absolute Maximum Ratings — 25A SCR

Symbol	Parameter	Test Conditions	Value	Unit
$I_{T(RMS)}$	RMS on-state current	Sxx25L: $T_C = 75^\circ\text{C}$	25	A
		Sxx25R/Sxx25N: $T_C = 100^\circ\text{C}$		
$I_{T(AV)}$	Average on-state current	Sxx25L $T_C = 75^\circ\text{C}$	16	A
		Sxx25R/Sxx25N $T_C = 100^\circ\text{C}$		
I_{TSM}	Peak non-repetitive surge current	single half cycle; $f = 50\text{Hz}$; T_J (initial) = 25°C	300	A
		single half cycle; $f = 60\text{Hz}$; T_J (initial) = 25°C	350	
I^2t	I^2t Value for fusing	$t_p = 8.3 \text{ ms}$	510	A^2s
di/dt	Critical rate of rise of on-state current	$f = 60\text{Hz}$; $T_J = 125^\circ\text{C}$	150	$\text{A}/\mu\text{s}$
I_{GM}	Peak gate current	$T_J = 125^\circ\text{C}$	3.5	A
$P_{G(AV)}$	Average gate power dissipation	$T_J = 125^\circ\text{C}$	0.8	W
T_{stg}	Storage temperature range		-40 to 150	$^\circ\text{C}$
T_J	Operating junction temperature range		-40 to 125	$^\circ\text{C}$

Electrical Characteristics ($T_J = 25^\circ\text{C}$, unless otherwise specified)

Symbol	Test Conditions			Value		Unit
				Sxx20L	Sxx25x	
I_{GT}	$V_D = 12\text{V}$ $R_L = 30 \Omega$	-	MAX.	30	35	mA
		-	MIN.	1	1	
V_{GT}	$V_D = 12\text{V}$ $R_L = 30 \Omega$	-	MAX.	1.5		V
dv/dt	$V_D = V_{DRM}$; gate open; $T_J = 100^\circ\text{C}$	400V	MIN.	450		V/ μs
		600V		425		
		800V		400		
		1000V		200		
	$V_D = V_{DRM}$; gate open; $T_J = 125^\circ\text{C}$	400V	350			
		600V	325			
800V		300				
V_{GD}	$V_D = V_{DRM}$ $R_L = 3.3 \text{ k}\Omega$ $T_J = 125^\circ\text{C}$	-	MIN.	0.2		V
I_H	$I_T = 400\text{mA}$ (initial)	-	MAX.	40	50	mA
t_q	(1)	-	MAX.	35		μs
t_{gt}	$I_G = 2 \times I_{GT}$ $\text{PW} = 15\mu\text{s}$ $I_T = 40\text{A}$	-	TYP.	2		μs

Note: xx = voltage, x = package

(1) $I_T = 2\text{A}$; $t_p = 50\mu\text{s}$; $dv/dt = 5\text{V}/\mu\text{s}$; $di/dt = 30\text{A}/\mu\text{s}$

Static Characteristics

Symbol	Test Conditions		Value	Unit		
V_{TM}	20A Device $I_T = 40A$; $t_p = 380\mu s$		MAX.	1.6	V	
	25A Device $I_T = 50A$; $t_p = 380\mu s$					
I_{DRM} / I_{RRM}	V_{DRM} / V_{RRM}	$T_J = 25^\circ C$	MAX.	400 – 600V	10	μA
				800 – 1000V	20	
				400 – 600V	500	
		$T_J = 100^\circ C$	800V	1000		
			1000V	3000		
			400 – 600V	1000		
		$T_J = 125^\circ C$	800V	2000		

Thermal Resistances

Symbol	Parameter	Value	Unit	
$R_{\theta(J-C)}$	Junction to case (AC)	Sxx25R / Sxx25N	1.0	$^\circ C/W$
		Sxx20L / Sxx25L	2.4	
$R_{\theta(J-A)}$	Junction to ambient	Sxx25R	40	$^\circ C/W$
		Sxx20L / Sxx25L	50	

Note: xx = voltage

Figure 1: Normalized DC Gate Trigger Current vs. Junction Temperature

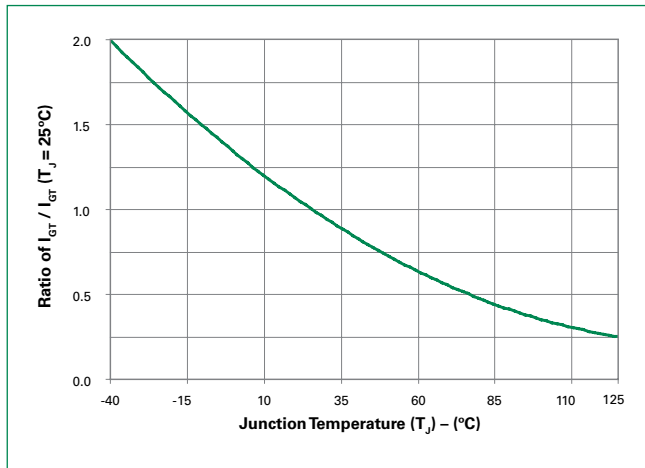

Figure 2: Normalized DC Gate Trigger Voltage vs. Junction Temperature

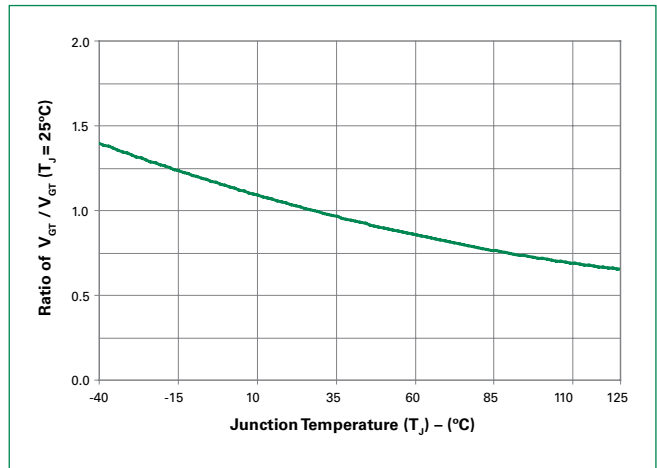

Figure 3: Normalized DC Holding Current vs. Junction Temperature

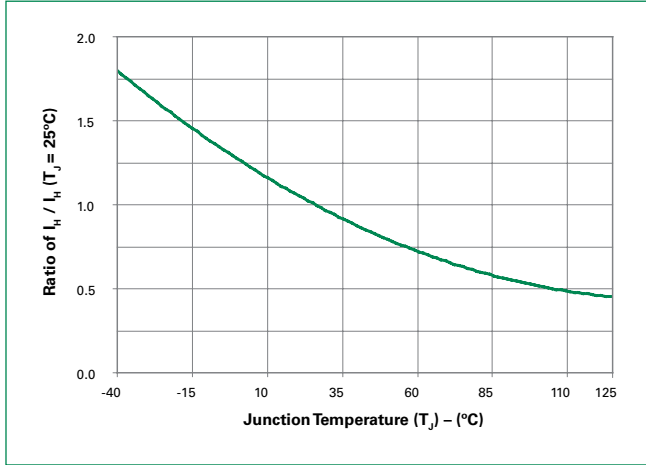

Figure 4: On-State Current vs. On-State Voltage (Typical)

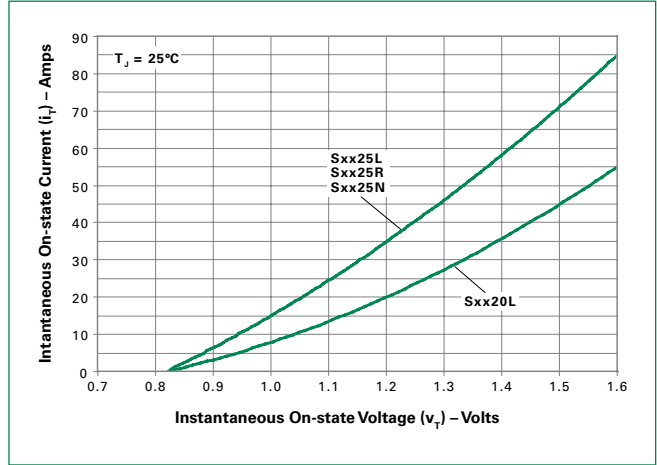

Figure 5: Power Dissipation (Typical) vs. RMS On-State Current

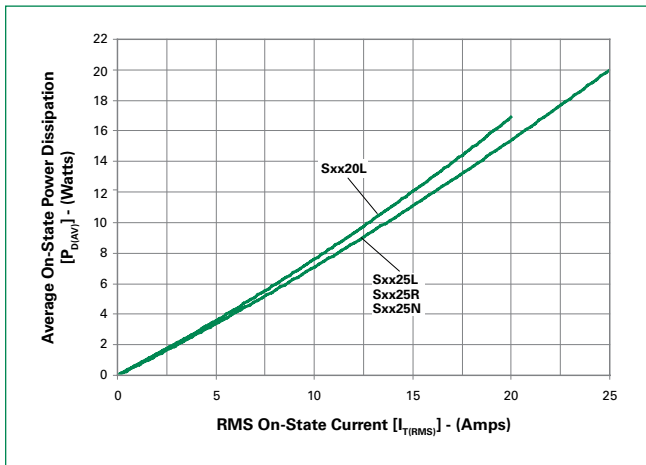

Figure 6: Maximum Allowable Case Temperature vs. RMS On-State Current

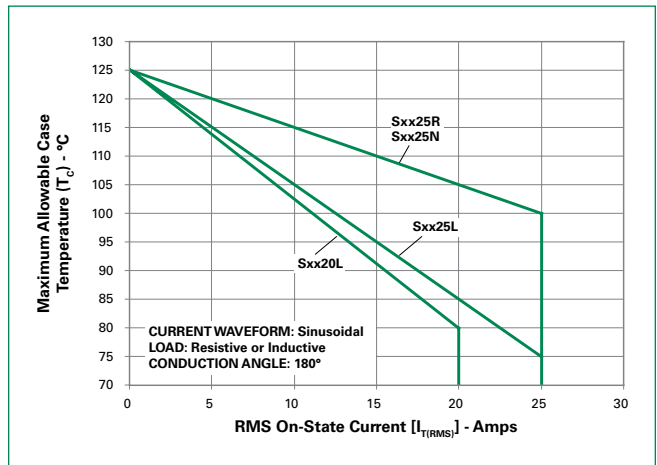

Figure 7: Maximum Allowable Case Temperature vs. Average On-State Current

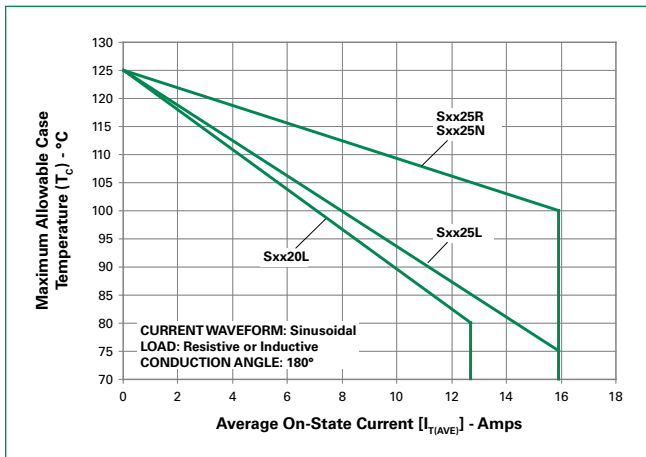

Figure 8: Maximum Allowable Ambient Temperature vs. RMS On-State Current

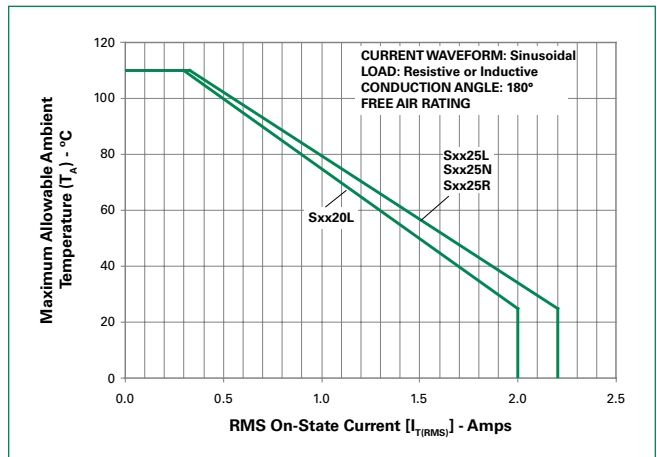
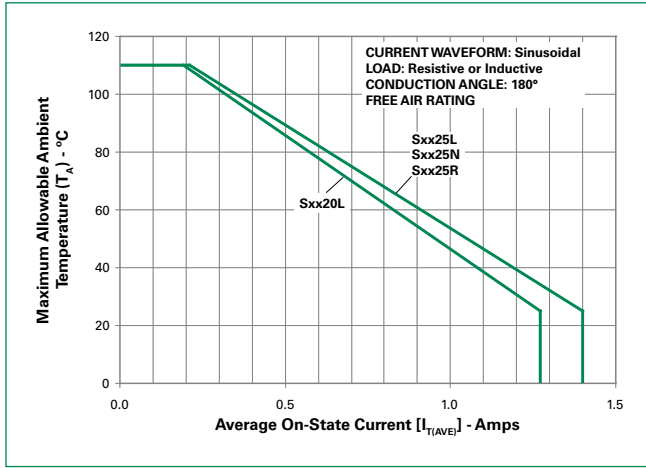

Figure 9: Maximum Allowable Ambient Temperature vs. Average On-State Current



Note: xx = voltage

Figure 10: Peak Capacitor Discharge Current

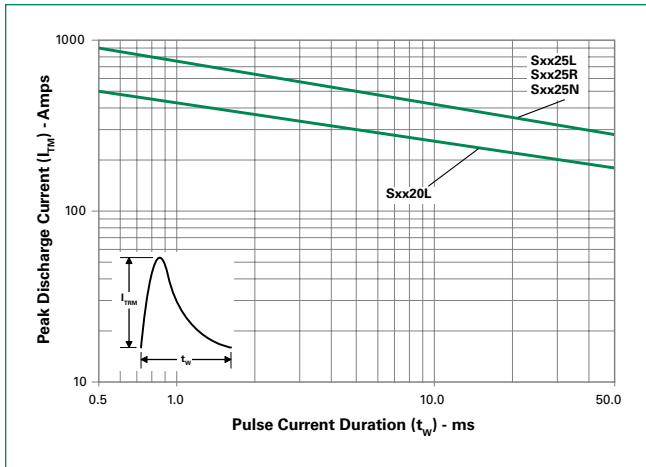

Figure 11: Peak Capacitor Discharge Current Derating

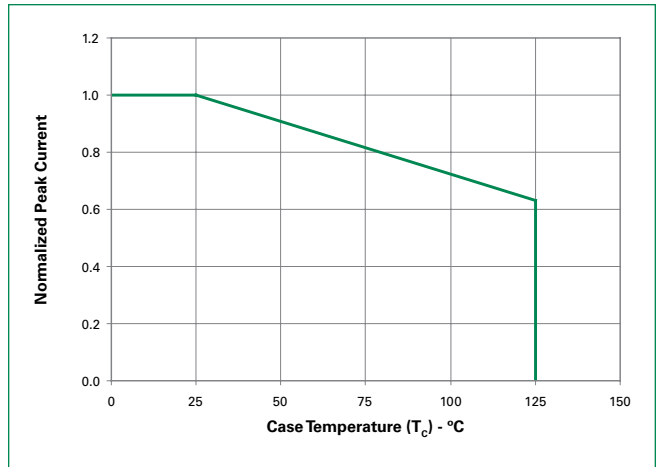
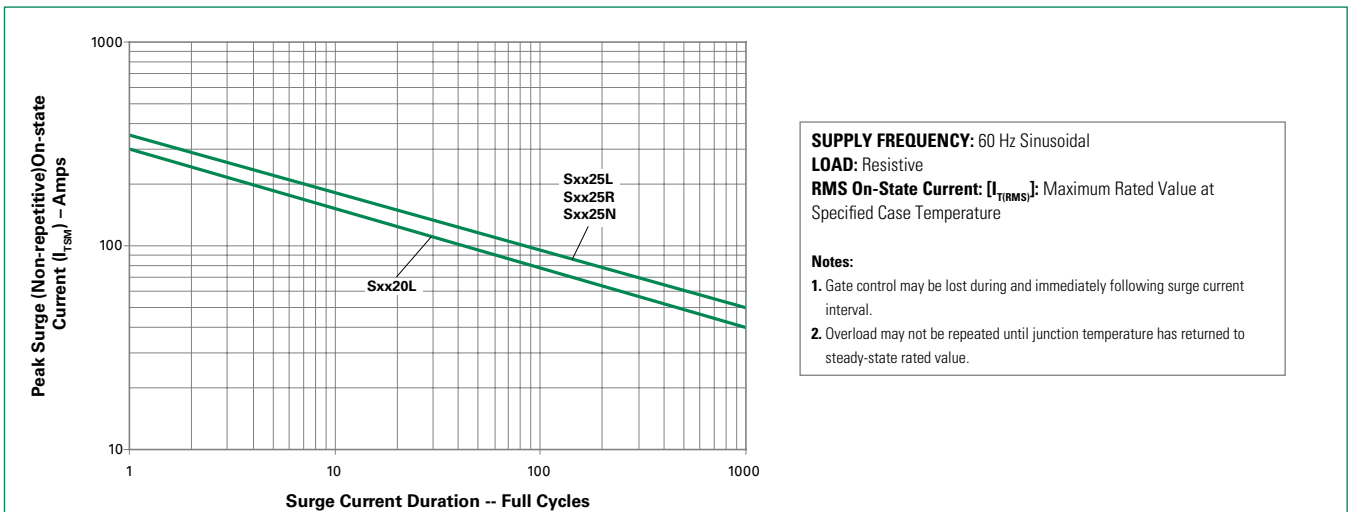
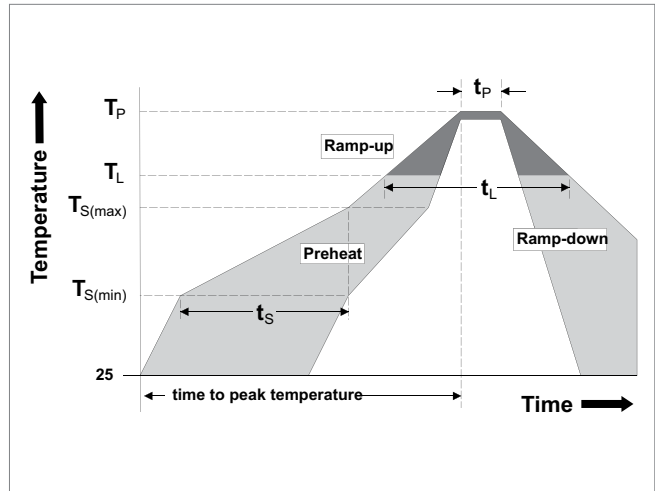

Figure 12: Surge Peak On-State Current vs. Number of Cycles



Soldering Parameters

Reflow Condition		Pb – Free assembly
Pre Heat	- Temperature Min ($T_{s(min)}$)	150°C
	- Temperature Max ($T_{s(max)}$)	200°C
	- Time (min to max) (t_s)	60 – 180 secs
Average ramp up rate (Liquidus Temp) (T_L) to peak		5°C/second max
$T_{s(max)}$ to T_L - Ramp-up Rate		5°C/second max
Reflow	- Temperature (T_L) (Liquidus)	217°C
	- Temperature (t_L)	60 – 150 seconds
Peak Temperature (T_p)		260 ^{+0/-5} °C
Time within 5°C of actual peak Temperature (t_p)		20 – 40 seconds
Ramp-down Rate		5°C/second max
Time 25°C to peak Temperature (T_p)		8 minutes Max.
Do not exceed		280°C



Physical Specifications

Terminal Finish	100% Matte Tin-plated
Body Material	UL recognized epoxy meeting flammability classification 94V-0
Lead Material	Copper Alloy

Design Considerations

Careful selection of the correct device for the application's operating parameters and environment will go a long way toward extending the operating life of the Thyristor. Good design practice should limit the maximum continuous current through the main terminals to 75% of the device rating. Other ways to ensure long life for a power discrete semiconductor are proper heat sinking and selection of voltage ratings for worst case conditions. Overheating, overvoltage (including dv/dt), and surge currents are the main killers of semiconductors. Correct mounting, soldering, and forming of the leads also help protect against component damage.

Environmental Specifications

Test	Specifications and Conditions
AC Blocking	MIL-STD-750, M-1040, Cond A Applied Peak AC voltage @ 125°C for 1008 hours
Temperature Cycling	MIL-STD-750, M-1051, 100 cycles; -40°C to +150°C; 15-min dwell-time
Temperature/Humidity	EIA / JEDEC, JESD22-A101 1008 hours; 320V - DC: 85°C; 85% rel humidity
High Temp Storage	MIL-STD-750, M-1031, 1008 hours; 150°C
Low-Temp Storage	1008 hours; -40°C
Resistance to Solder Heat	MIL-STD-750 Method 2031
Solderability	ANSI/J-STD-002, category 3, Test A
Lead Bend	MIL-STD-750, M-2036 Cond E

Dimensions — TO-220AB (R-Package) — Non-Isolated Mounting Tab Common with Center Lead

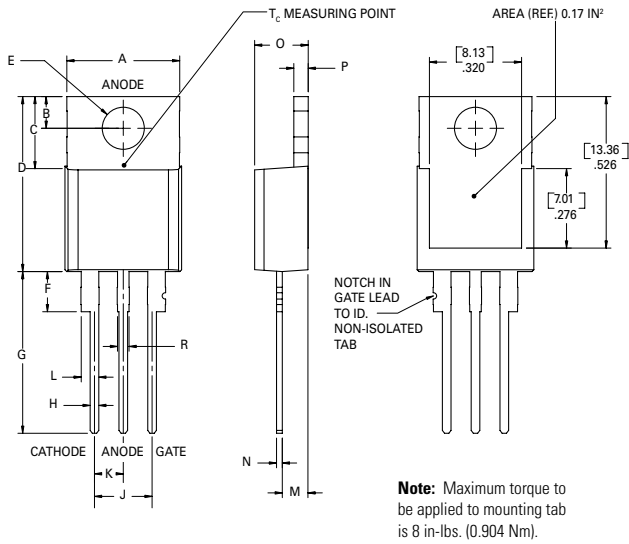

Dimension	Inches		Millimeters	
	Min	Max	Min	Max
A	0.380	0.420	9.65	10.67
B	0.105	0.115	2.67	2.92
C	0.230	0.250	5.84	6.35
D	0.590	0.620	14.99	15.75
E	0.142	0.147	3.61	3.73
F	0.110	0.130	2.79	3.30
G	0.540	0.575	13.72	14.61
H	0.025	0.035	0.64	0.89
J	0.195	0.205	4.95	5.21
K	0.095	0.105	2.41	2.67
L	0.060	0.075	1.52	1.91
M	0.085	0.095	2.16	2.41
N	0.018	0.024	0.46	0.61
O	0.178	0.188	4.52	4.78
P	0.045	0.060	1.14	1.52
R	0.038	0.048	0.97	1.22

Dimensions — TO-220AB (L-Package) — Isolated Mounting Tab

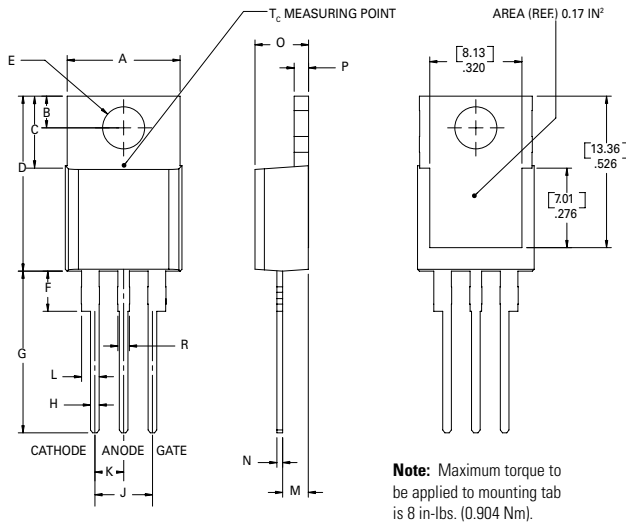

Dimension	Inches		Millimeters	
	Min	Max	Min	Max
A	0.380	0.420	9.65	10.67
B	0.105	0.115	2.67	2.92
C	0.230	0.250	5.84	6.35
D	0.590	0.620	14.99	15.75
E	0.142	0.147	3.61	3.73
F	0.110	0.130	2.79	3.30
G	0.540	0.575	13.72	14.61
H	0.025	0.035	0.64	0.89
J	0.195	0.205	4.95	5.21
K	0.095	0.105	2.41	2.67
L	0.060	0.075	1.52	1.91
M	0.085	0.095	2.16	2.41
N	0.018	0.024	0.46	0.61
O	0.178	0.188	4.52	4.78
P	0.045	0.060	1.14	1.52
R	0.038	0.048	0.97	1.22

Dimensions –TO- 263AB (N-package) – D²-Pak Surface Mount

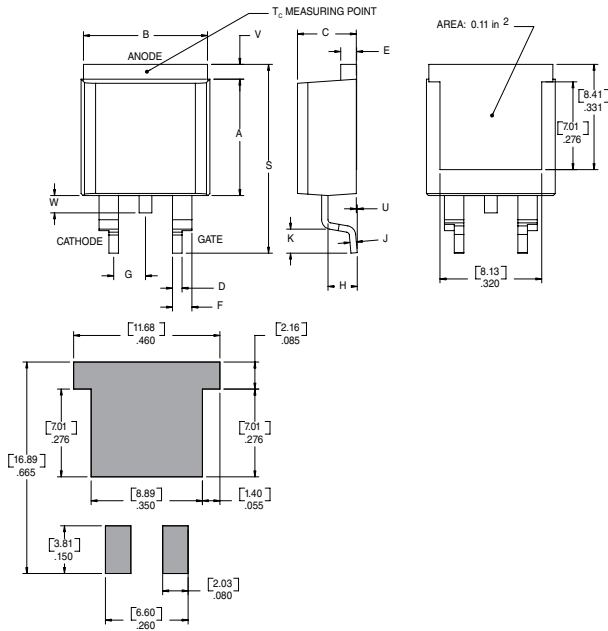

Dimension	Inches		Millimeters	
	Min	Max	Min	Max
A	0.360	0.370	9.14	9.40
B	0.380	0.420	9.65	10.67
C	0.178	0.188	4.52	4.78
D	0.025	0.035	0.64	0.89
E	0.045	0.060	1.14	1.52
F	0.060	0.075	1.52	1.91
G	0.095	0.105	2.41	2.67
H	0.092	0.102	2.34	2.59
J	0.018	0.024	0.46	0.61
K	0.090	0.110	2.29	2.79
S	0.590	0.625	14.99	15.88
V	0.035	0.045	0.89	1.14
U	0.002	0.010	0.05	0.25
W	0.040	0.070	1.016	1.78

Product Selector

Part Number	Voltage				Gate Sensitivity	Type	Package
	400V	600V	800V	1000V			
Sxx20L	X	X	X	X	30mA	Standard SCR	TO-220L
Sxx25L	X	X	X	X	35mA	Standard SCR	TO-220L
Sxx25R	X	X	X	X	35mA	Standard SCR	TO-220R
Sxx25N	X	X	X	X	35mA	Standard SCR	TO-263

Note: xx = Voltage

Packing Options

Part Number	Marking	Weight	Packing Mode	Base Quantity
Sxx20LTP	Sxx20L	2.2g	Tube	1000 (50 per tube)
Sxx25LTP	Sxx25L	2.2g	Tube	1000 (50 per tube)
Sxx25RTP	Sxx25R	2.2g	Tube	1000 (50 per tube)
Sxx25NTP	Sxx25N	1.6g	Tube	1000 (50 per tube)
Sxx25NRP	Sxx25N	1.6g	Embossed Carrier	500

Note: xx = Voltage

TO-263 Embossed Carrier Reel Pack (RP) Specifications

Meets all EIA-481-2 Standards

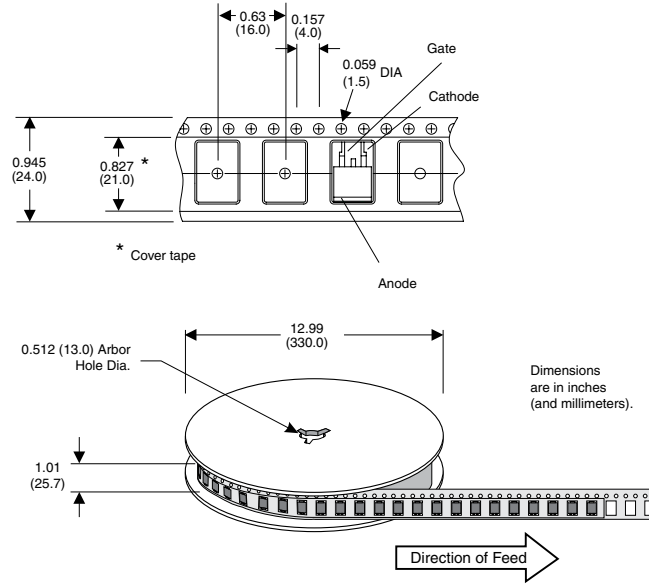

Part Numbering System

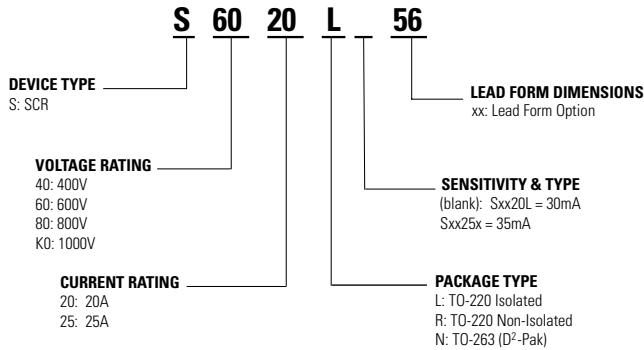

Part Marking System

TO-220 AB - (L and R Package)
TO-263 AB - (N Package)

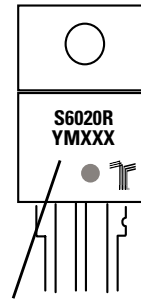

Date Code Marking
Y: Year Code
M: Month Code
XXX: Lot Trace Code

Looking for pricing, stock, or lifecycle information?

Click below to explore more details on WIN SOURCE:

 [View SK025LTP on WIN SOURCE](#)

 [Littelfuse Inc. Information](#)

Optimize Your Supply Chain with WIN SOURCE Solutions

-  Global Sourcing Solution
-  Obsolete Management
-  Cost Control Management
-  Shortage Management
-  Alternative Solution
-  Excess Inventory Management