



**THE DATASHEET OF  
FXP840.07.0055B**





# TAOGLAS®



# Datasheet

## Freedom

**Part No:**  
FXP840.07.0055B

## Description

FXP840 Freedom Series super small Wi-Fi 2.4/5.8/7.125GHz flexible monopole antenna with Wi-Fi 6 capabilities

## Features:

Wi-Fi (Including Wi-Fi 6) 2.4-2.5, 4.9-5.8, 5.9-7.125 GHz  
Flexible and Tiny - Ultra Low Profile  
Adheres directly inside of product plastic or glass housing  
Form factor and cable routing convenient for integration  
I-PEX MHF I Connector (U.FL compatible)  
55mm  $\varnothing$  0.81mm mini-coaxial cable  
Dimensions: 14\*5\*0.1mm  
RoHS & Reach Compliant

<b>1.</b>	<b>Introduction</b>	<b>3</b>
<b>2.</b>	<b>Specification</b>	<b>5</b>
<b>3.</b>	<b>Antenna Characteristics</b>	<b>6</b>
<b>4.</b>	<b>Radiation Patterns</b>	<b>10</b>
<b>5.</b>	<b>Mechanical Drawing</b>	<b>20</b>
<b>6.</b>	<b>Packaging</b>	<b>21</b>
<hr/>		
	Changelog	22

Taoglas makes no warranties based on the accuracy or completeness of the contents of this document and reserves the right to make changes to specifications and product descriptions at any time without notice. Taoglas reserves all rights to this document and the information contained herein. Reproduction, use or disclosure to third parties without express permission is strictly prohibited.



# 1. Introduction



The patent pending FXP840 is a super small, ultra-low profile monopole antenna for Wi-Fi applications over the 2.4, 4.9-5.8 and 5.8-7.125GHz bands. Engineered for Wi-Fi (including Wi-Fi 6), Bluetooth, ZigBee and other applications in these bands, including C-V2X and DSRC.

This Taoglas patent pending antenna is unique in the market because it is made from poly-flexible material, has a tiny form factor, just 14mm\*5.0mm\*0.1mm, and has double-sided 3M tape for easy “peel and stick” mounting. The cable routes conveniently directly from the edge of the antenna, reducing the volume the antenna takes up in the device to an absolute minimum, compared to other antenna designs.

The FXP840 is the ideal all-round antenna solution for fitting into compact spaces and still maintaining high performance, for example on the inside top or adjacent side applied directly to the plastic housing of LCD monitors, tablets, smartphones.

Many module manufacturers specify peak gain limits for any antennas that are to be connected to that module. Those peak gain limits are based on free-space conditions. In practice, the peak gain of an antenna tested in free-space can degrade by at least 1 or 2dBi when put inside a device. So ideally you should go for a slightly higher peak gain antenna than mentioned on the module specification to compensate for this effect, giving you better performance.

Upon testing of any of our antennas with your device and a selection of appropriate layout, integration technique, or cable, Taoglas can make sure any of our antennas’ peak gain will be below the peak gain limits. Taoglas can then issue a specification and/or report for the selected antenna in your device that will clearly show it complying with the peak gain limits, so you can be assured you are meeting regulatory requirements for that module.

For example, a module manufacturer may state that the antenna must have less than 2dBi peak gain, but you don't need to select an embedded antenna that has a peak gain of less than 2dBi in free-space. This will give you a less optimized solution. It is better to go for a slightly higher free-space peak gain of 3dBi or more if available. Once that antenna gets integrated into your device, performance will degrade below this 2dBi peak gain due to the effects of GND plane, surrounding components, and device housing. If you want to be absolutely sure, contact Taoglas and we will test. Choosing a Taoglas antenna with a higher peak gain than what is specified by the module manufacturer and enlisting our help will ensure you are getting the best performance possible without exceeding the peak gain limits.

The cable and connector are fully customizable. For more information, or how to integrate the antenna into your device, contact your local Taoglas customer service team.



## 2. Specification

Wi-Fi Electrical								
Band	Frequency (MHz)	Efficiency (%)	Average Gain (dB)	Peak Gain (dBi)	Impedance	Polarization	Radiation Pattern	Max. input power
Wi-Fi - 2GHz	2400-2500	39.8	-4.00	3.35	50 $\Omega$	Linear	Omni	2W
Wi-Fi - 5GHz	5150-5850	28.3	-5.48	3.37				
Wi-Fi - 6GHz	5925-7125	35.4	-4.51	5.31				
Tested on 1mm ABS (Plastic)								

Mechanical	
Dimensions	14 x 5 x 0.1 mm
Material	Polymer
Connector	I-PEX MHF I (U.FL Compatible)
Cable	55mm of $\varnothing$ 0.81mm
Weight	1g

Environmental	
Operation Temperature	-40°C to +85°C
Storage Temperature	-40°C to +85°C
Humidity	Non-condensing 65°C 95% RH
RoHS Compliant	Yes
REACH Compliant	Yes

### 3. Antenna Characteristics

#### 3.1 Test Setup

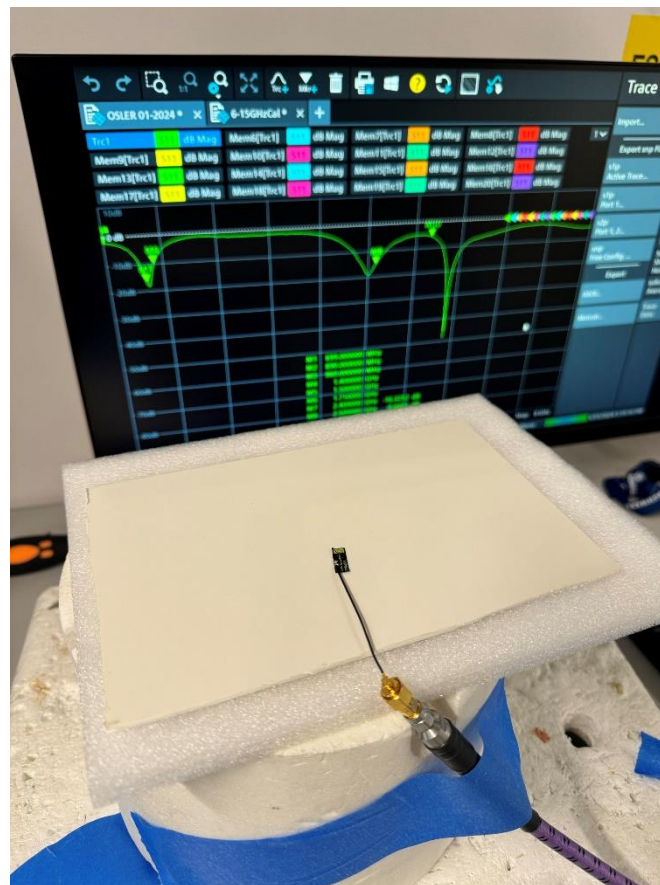
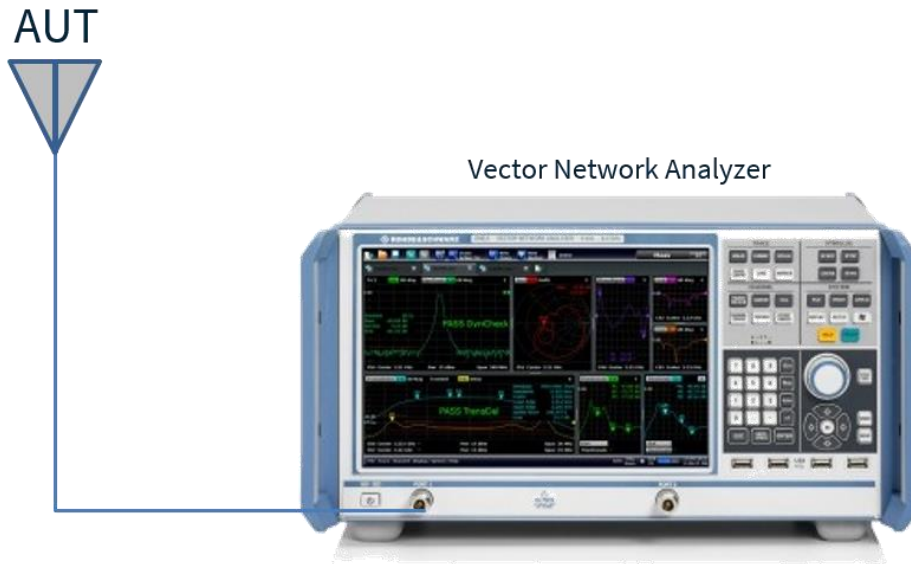

VNA test setup on 1mm ABS (Plastic) Ground Plane

### 3.2 Return Loss

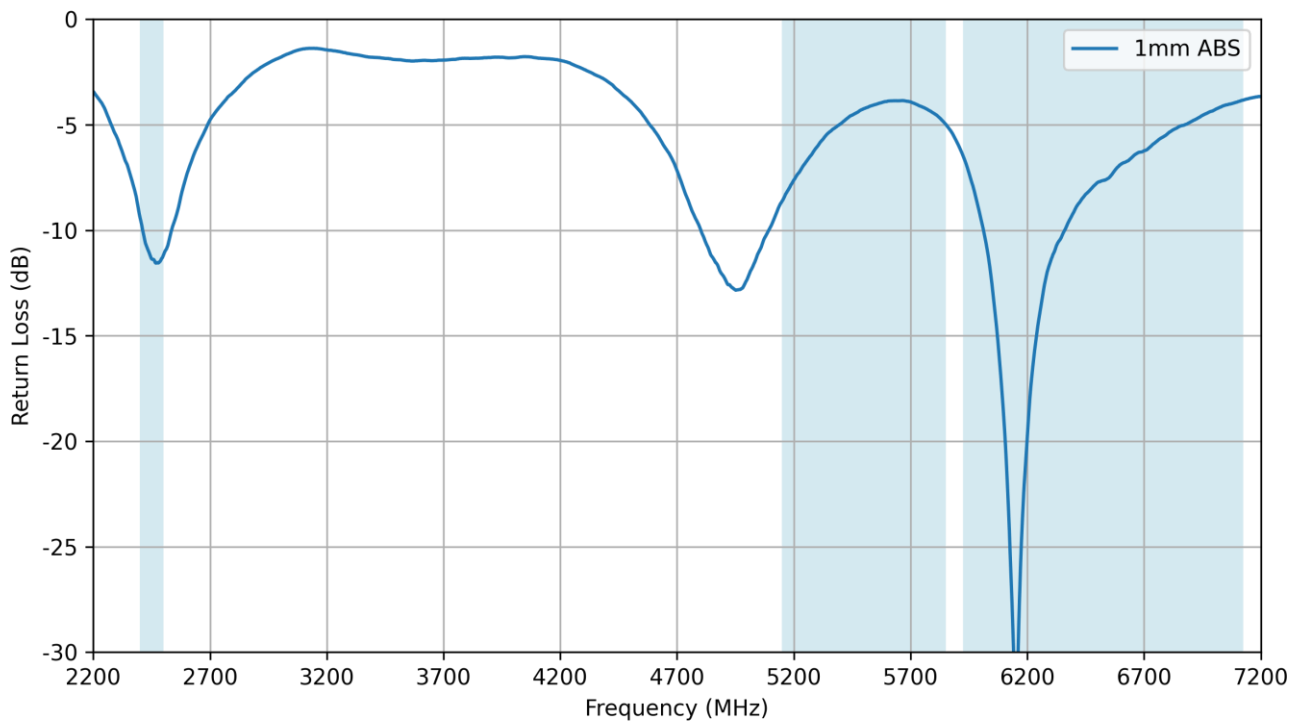

### 3.3 VSWR

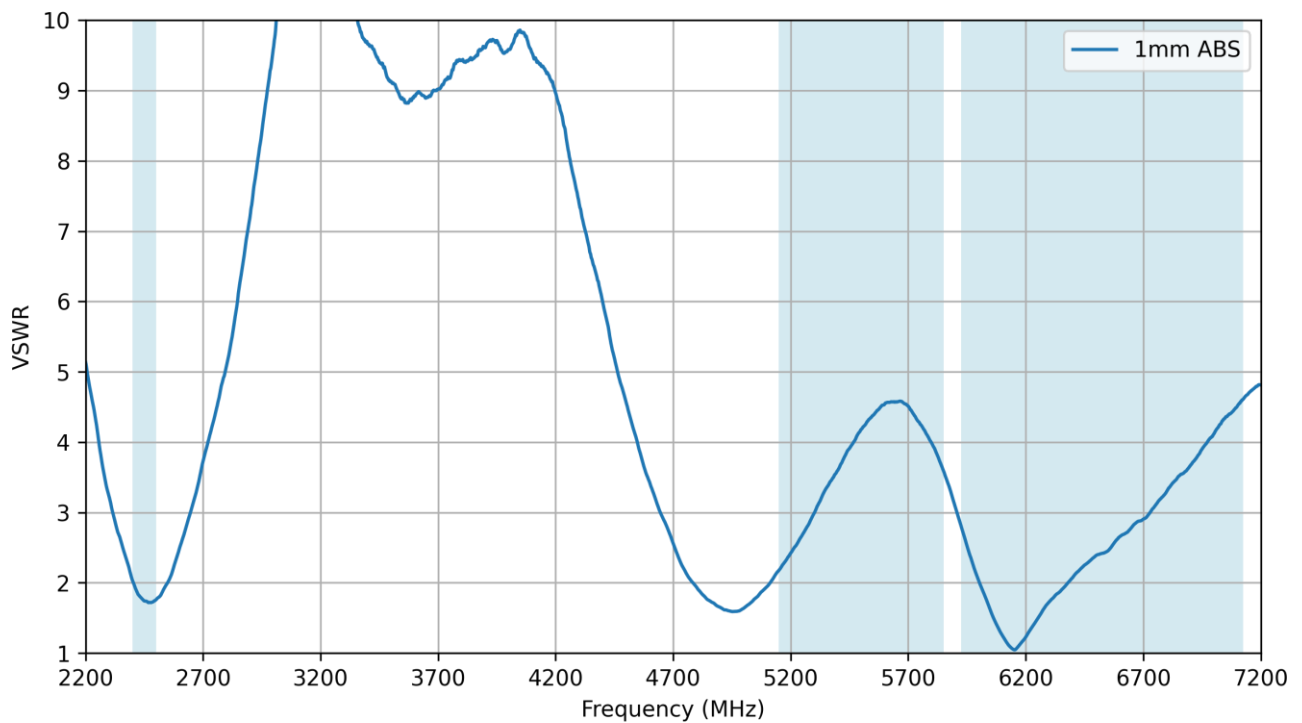

### 3.4 Efficiency

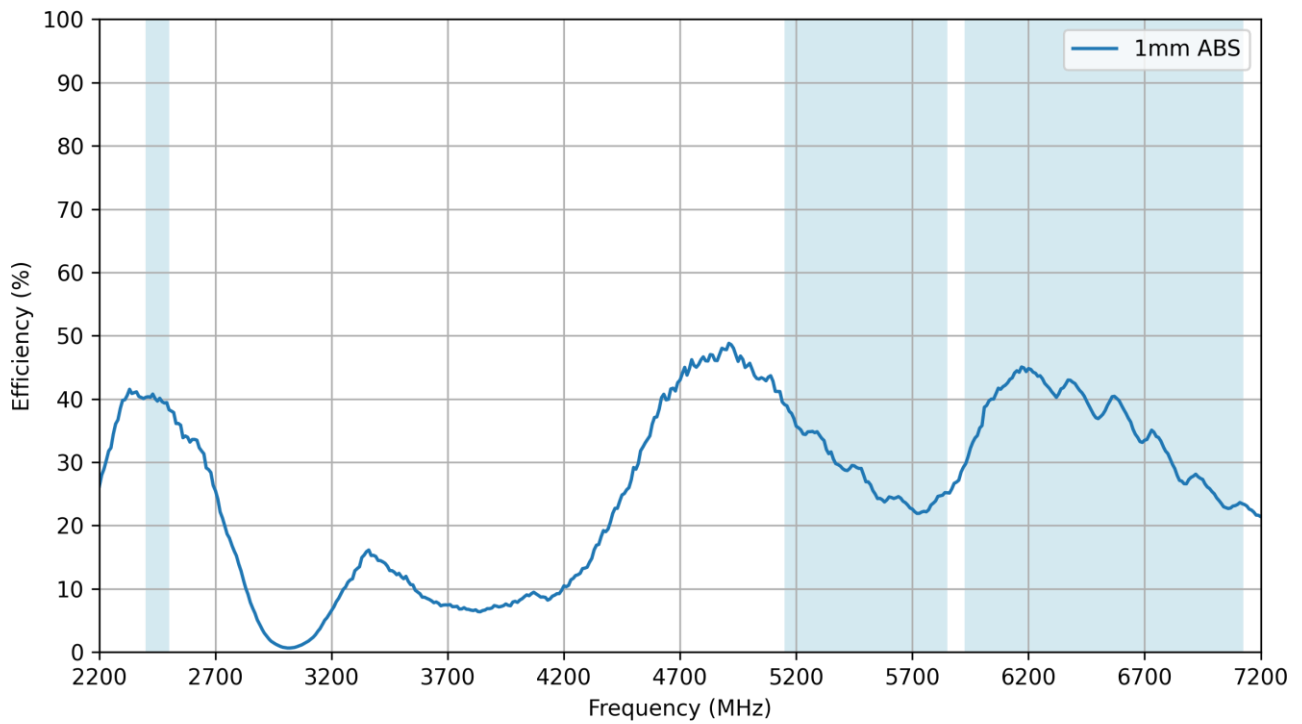

### 3.5 Average Gain

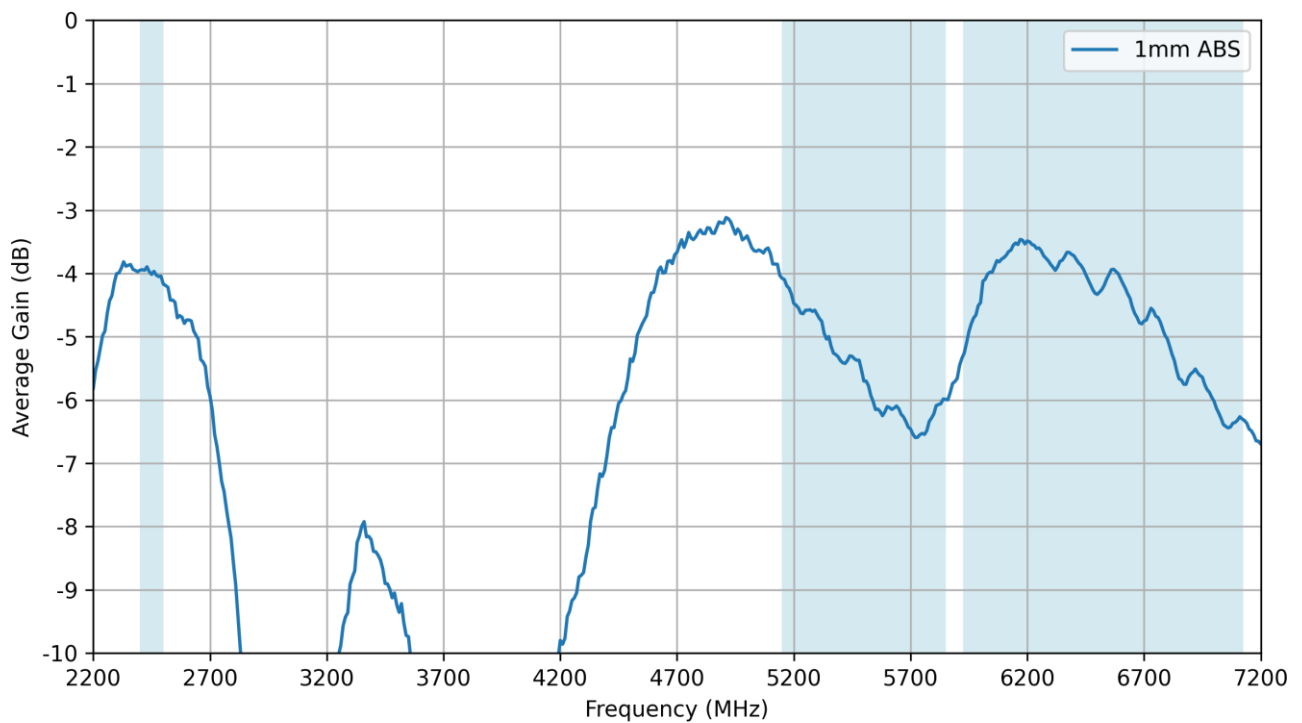

### 3.6 Peak Gain

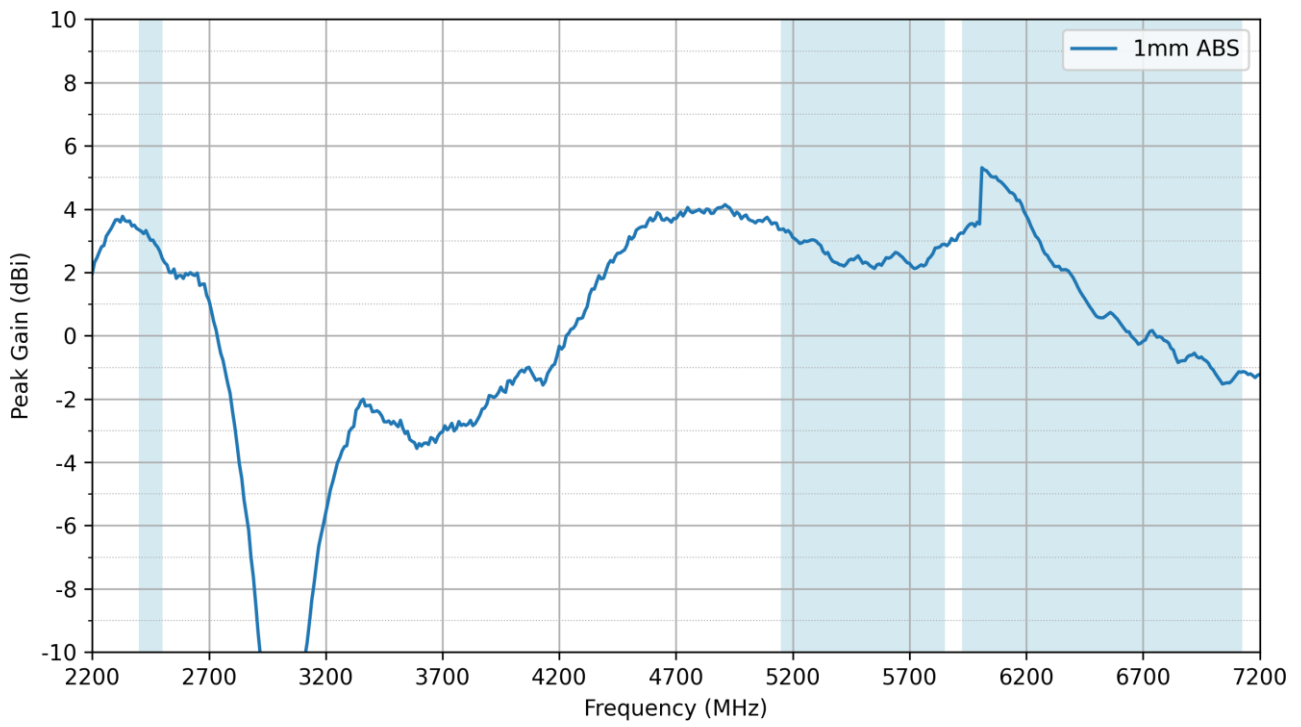

## 4. Radiation Patterns

### 4.1 Test Setup

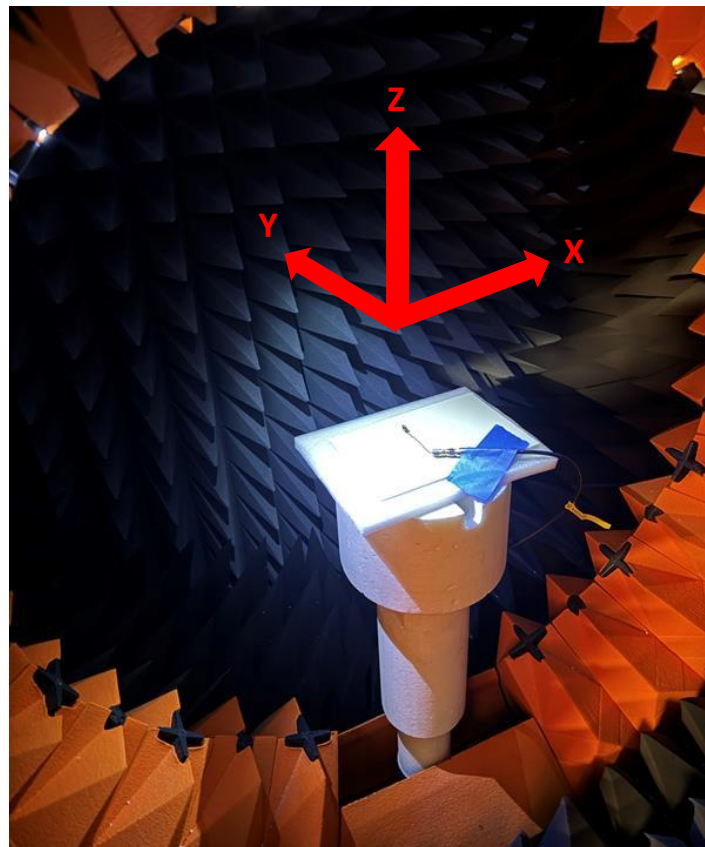
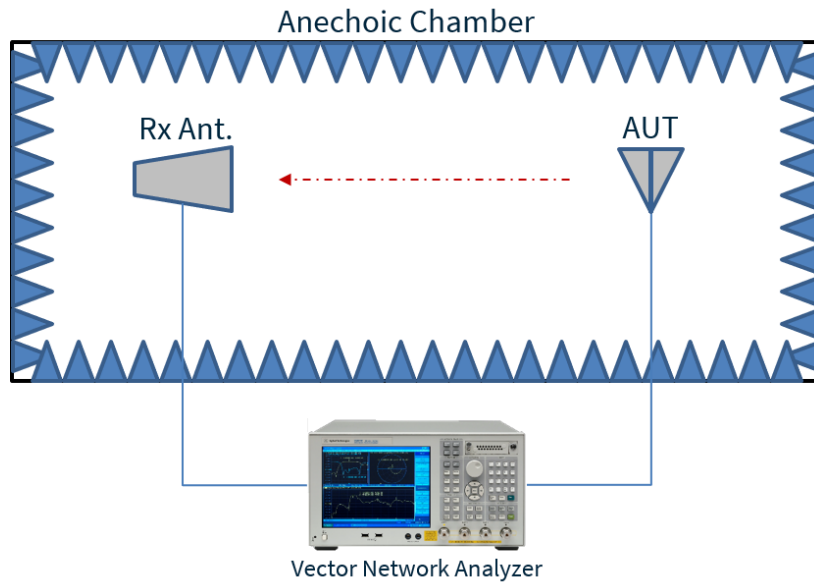

Chamber test setup on 1mm ABS (Plastic) Ground Plane

4.2 Patterns at 2400 MHz

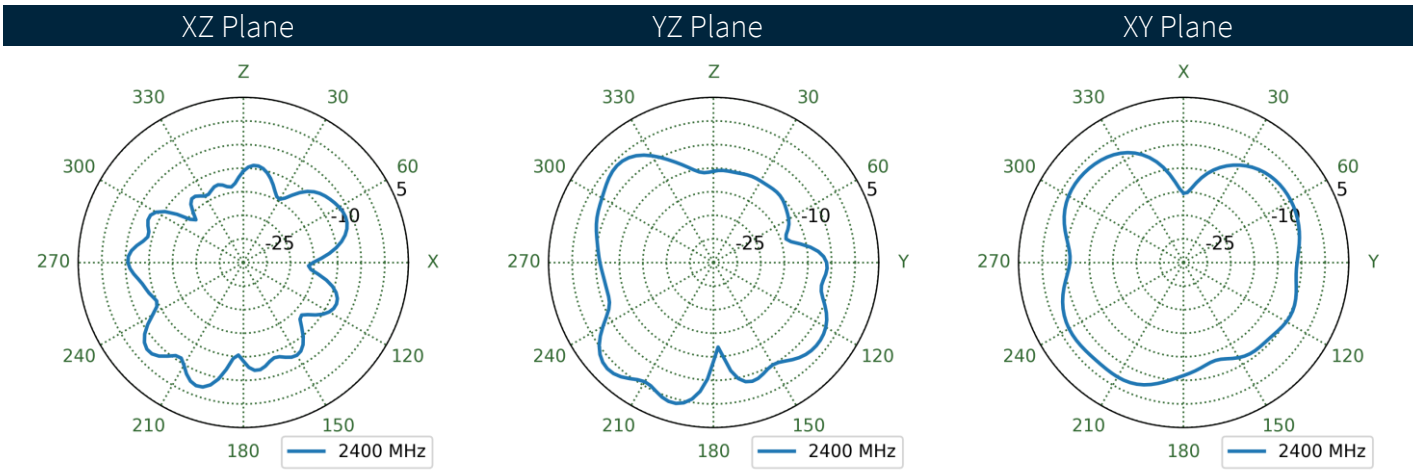
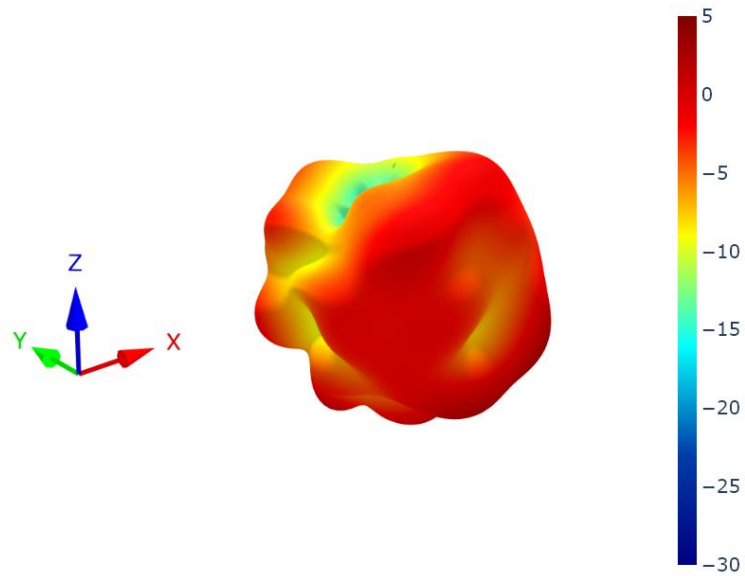

4.3 Patterns at 2450 MHz

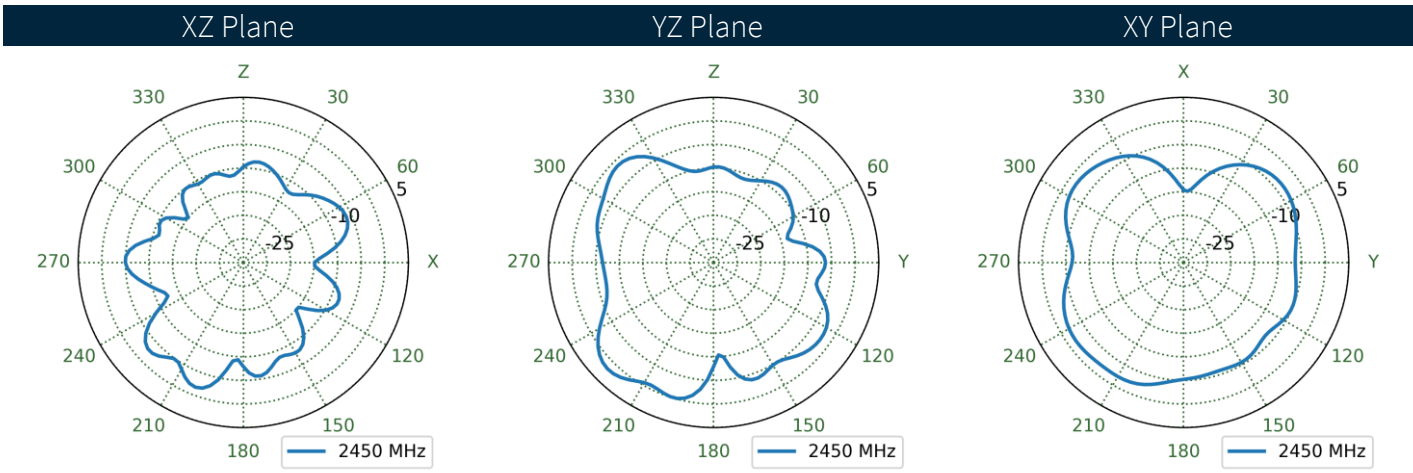
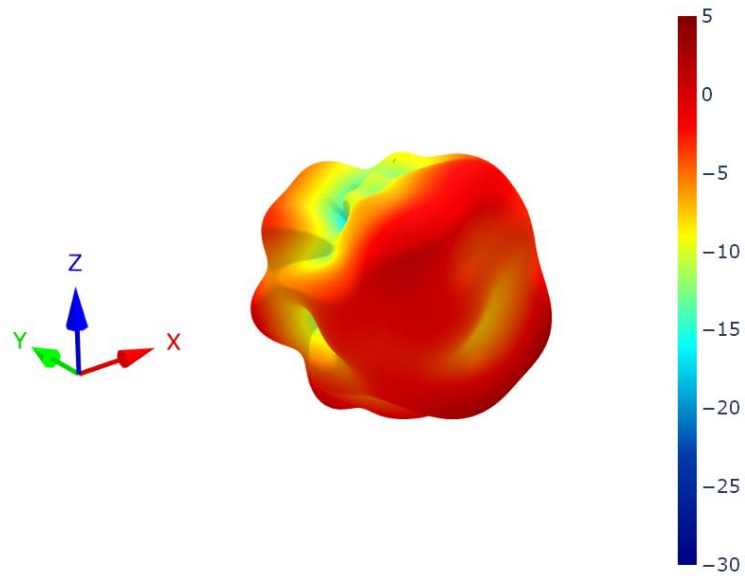

4.4 Patterns at 2500 MHz

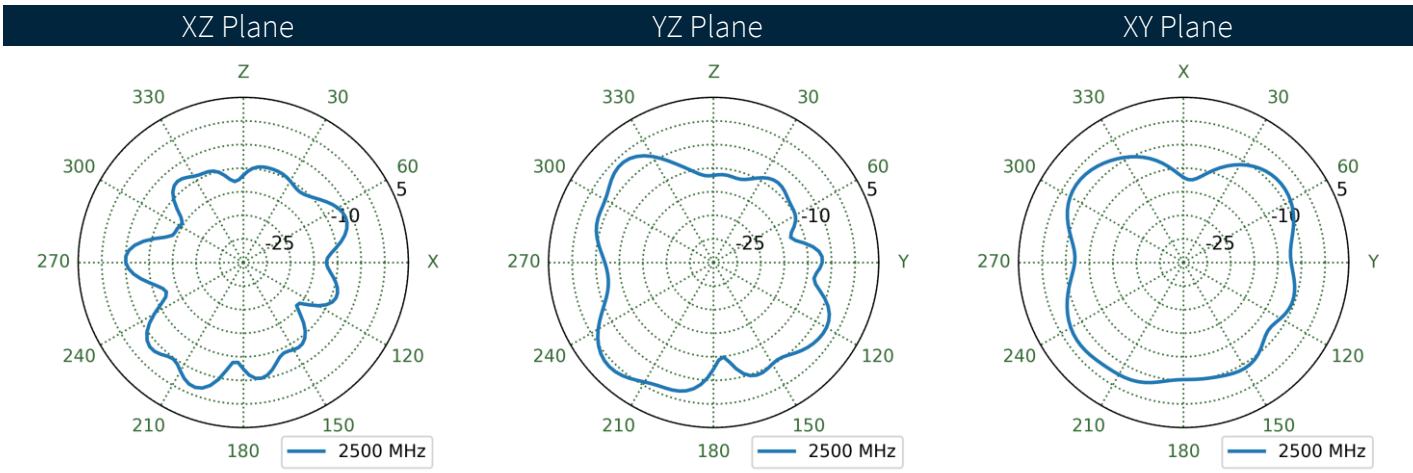
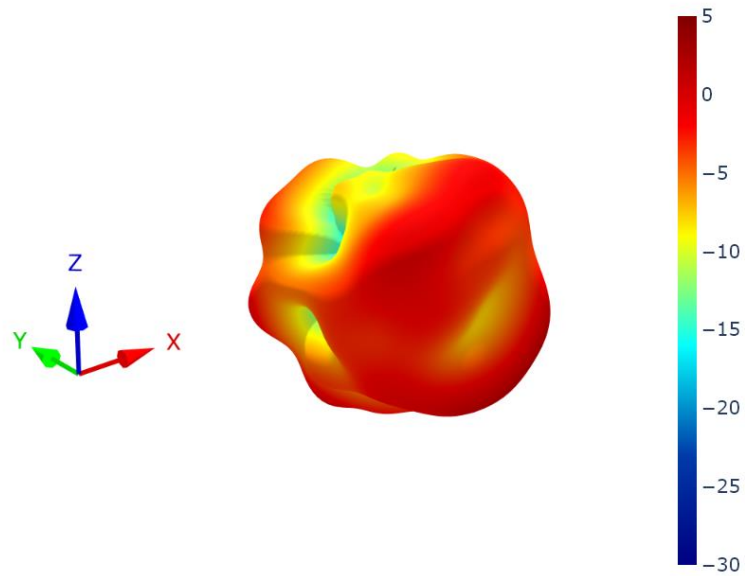

4.5 Patterns at 5150 MHz

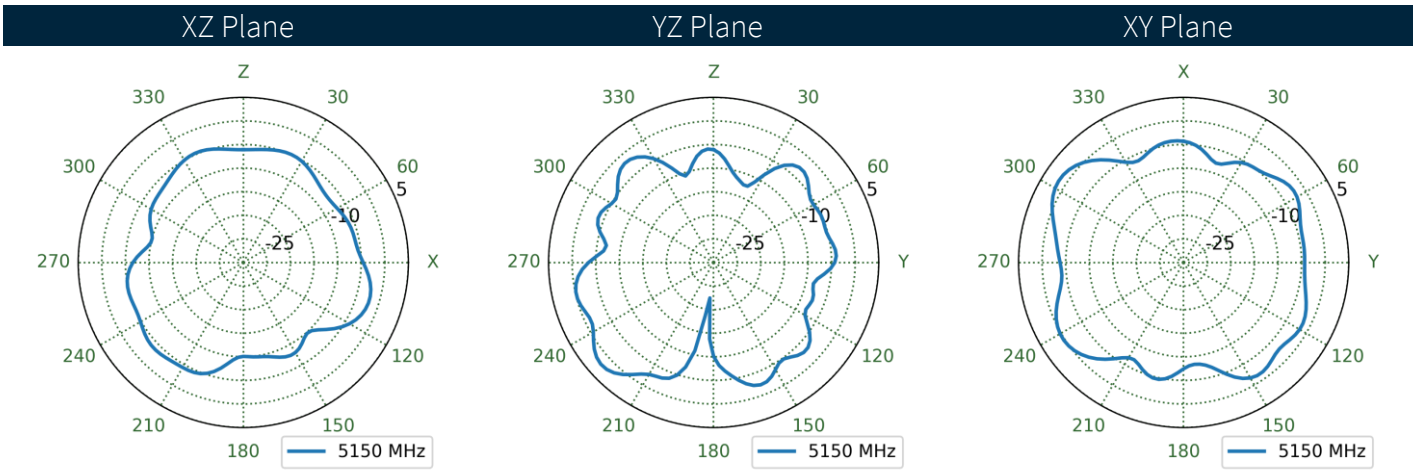
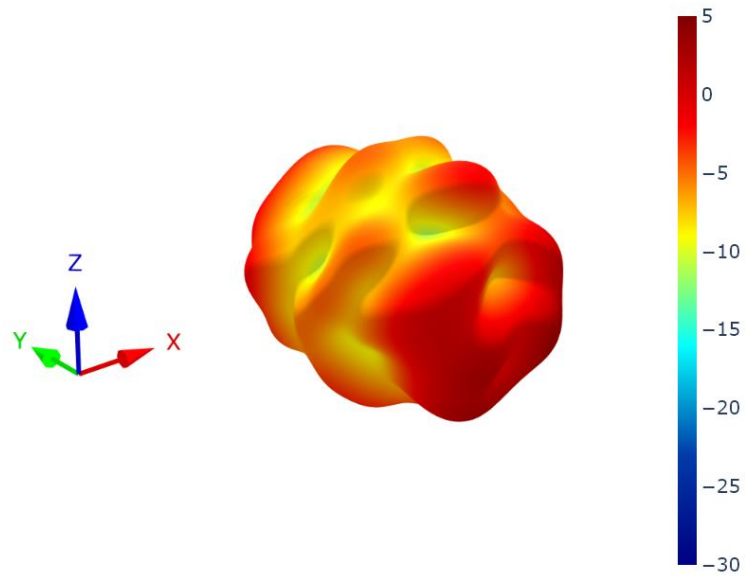

4.6 Patterns at 5350 MHz

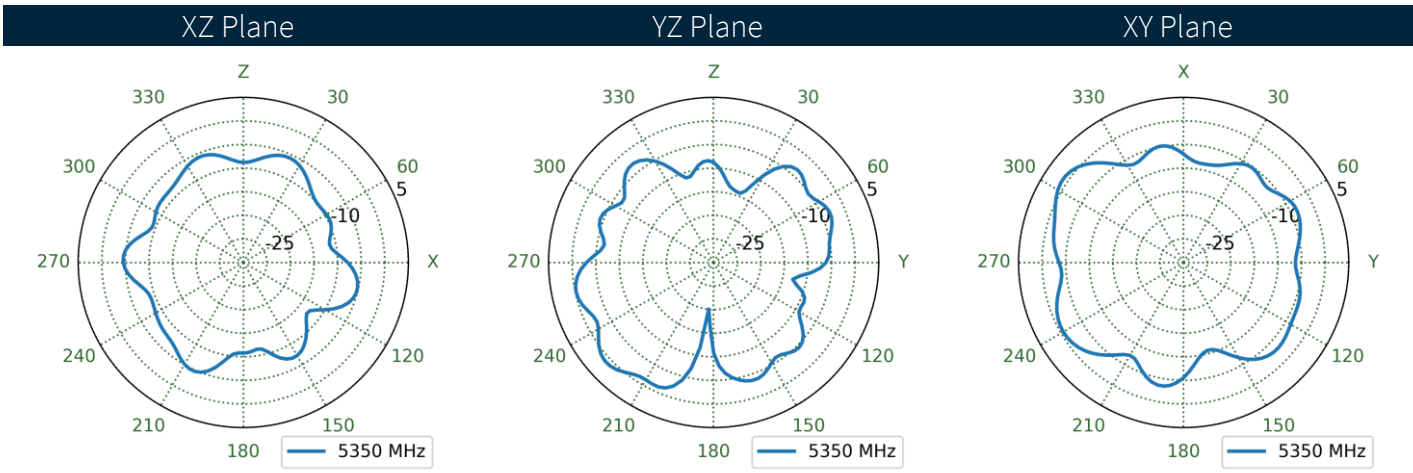
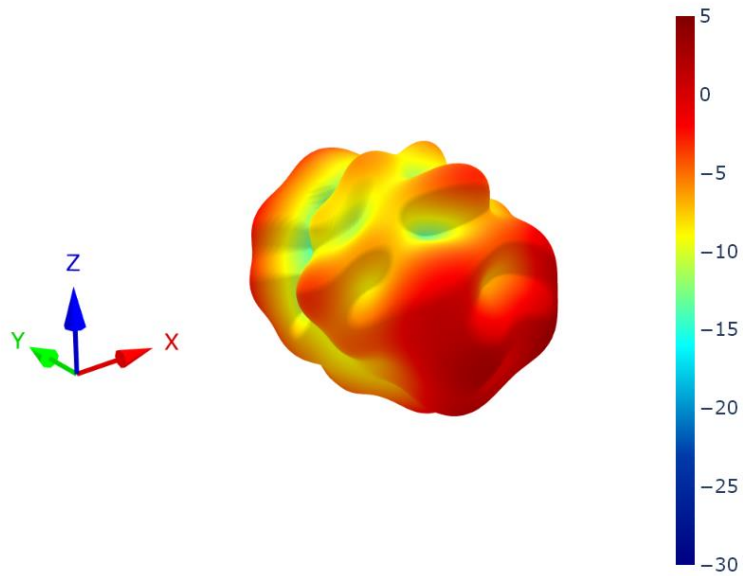

4.7 Patterns at 5850 MHz

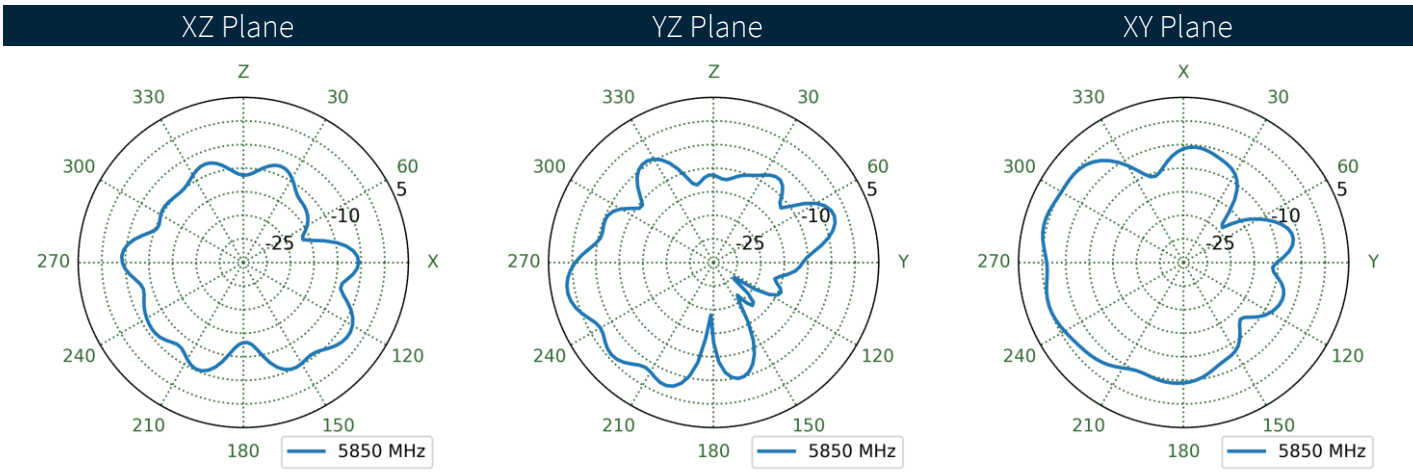
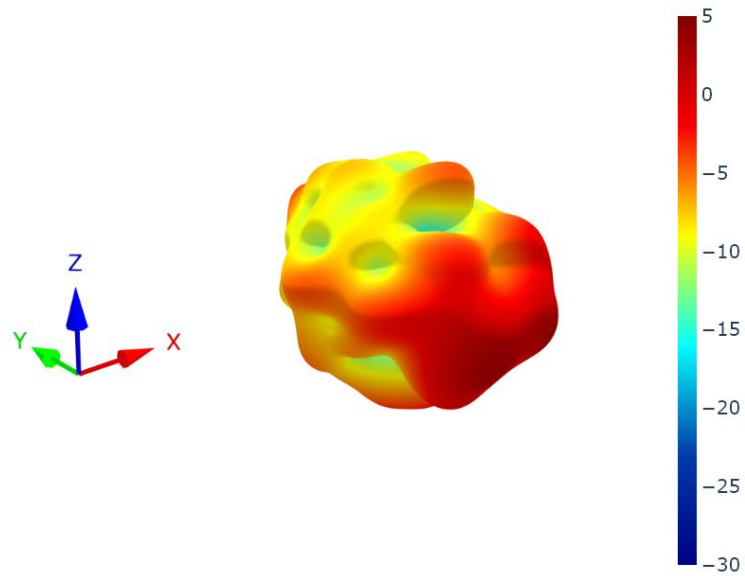

4.8 Patterns at 5925 MHz

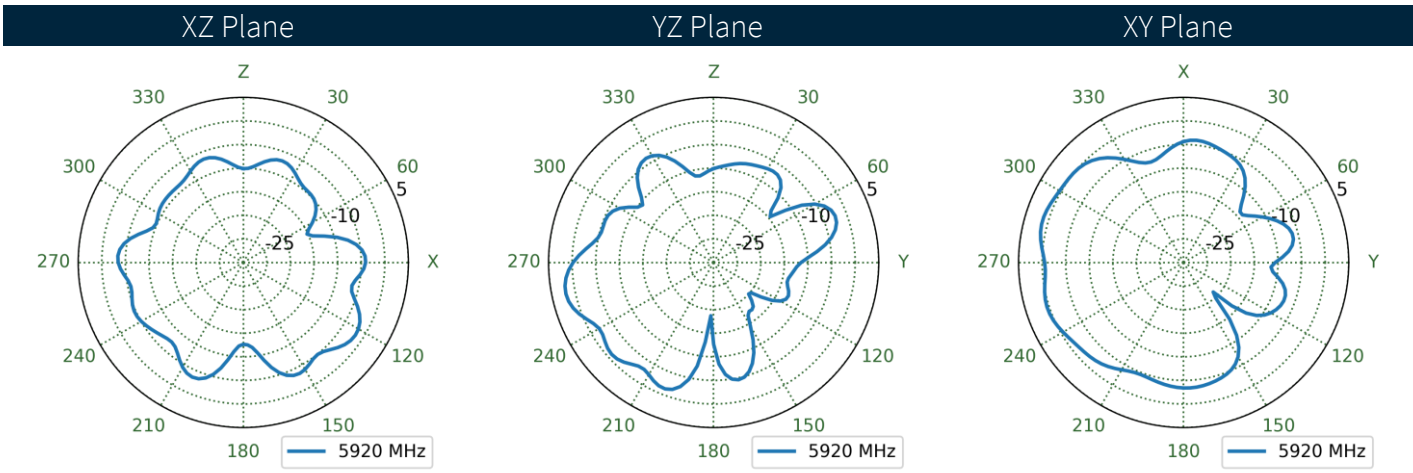
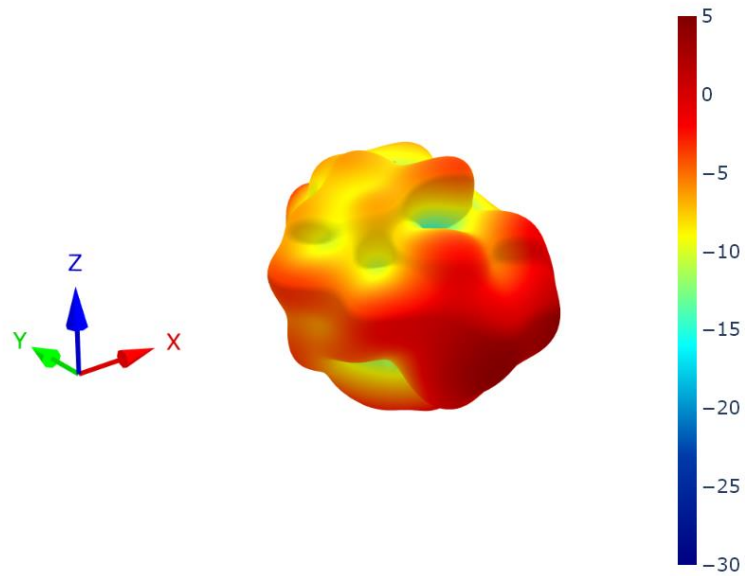

4.9 Patterns at 6525 MHz

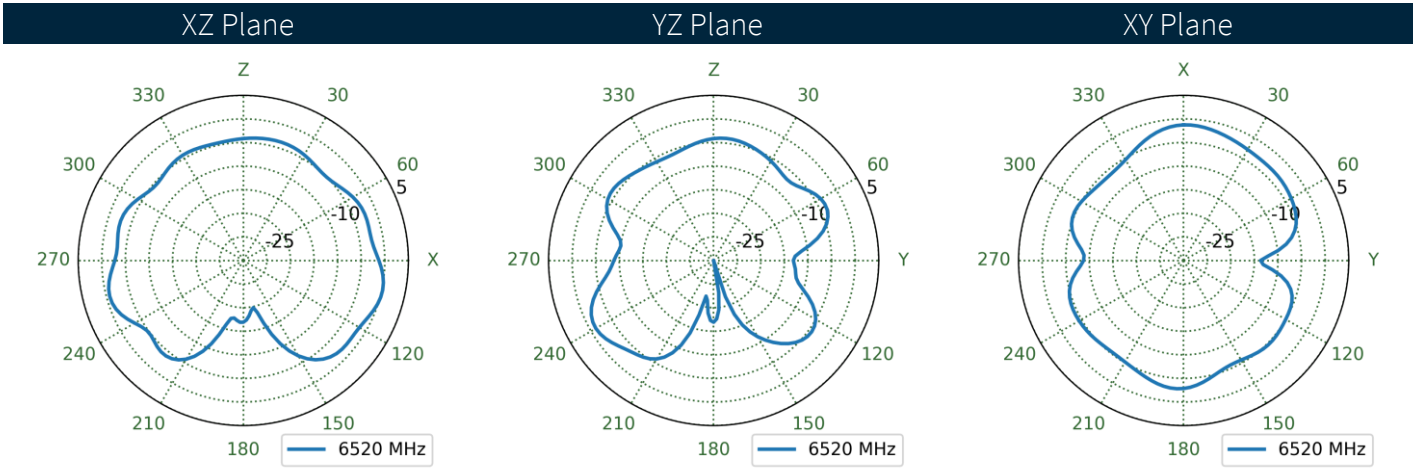
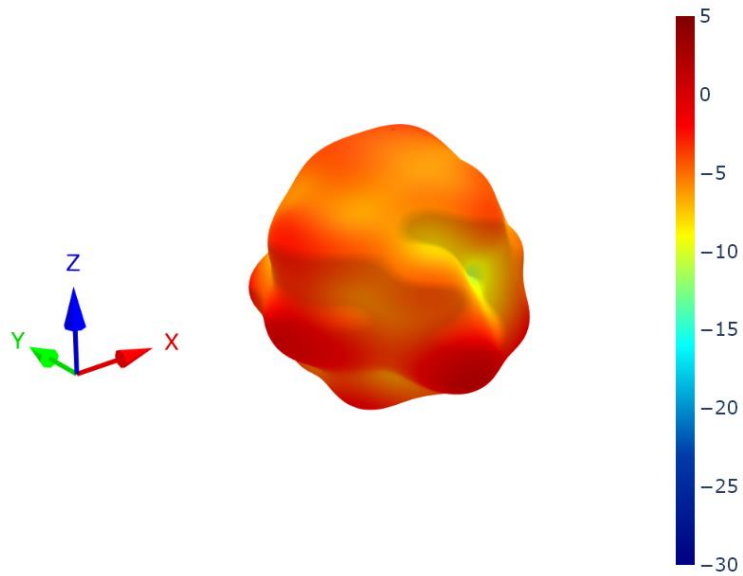

4.10 Patterns at 7125 MHz

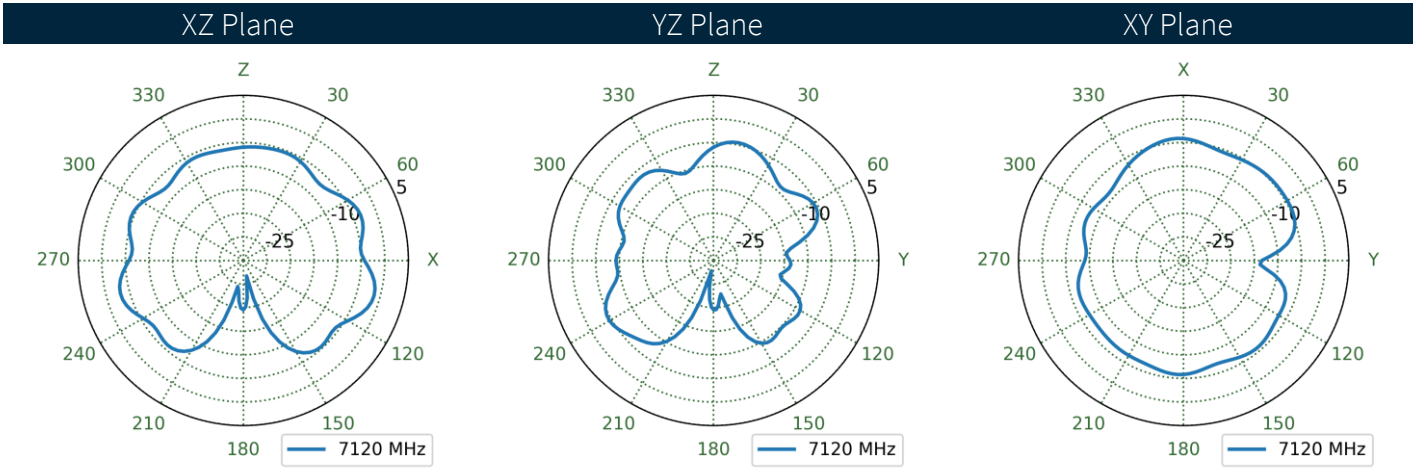
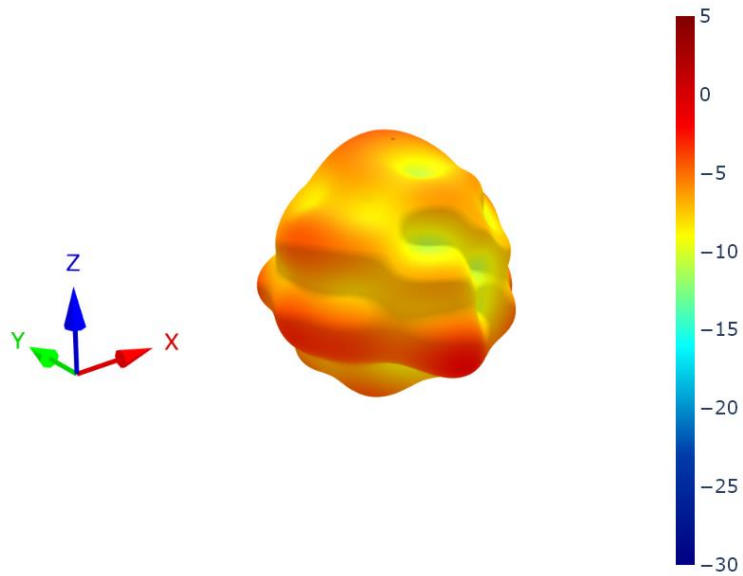

# 5. Mechanical Drawing

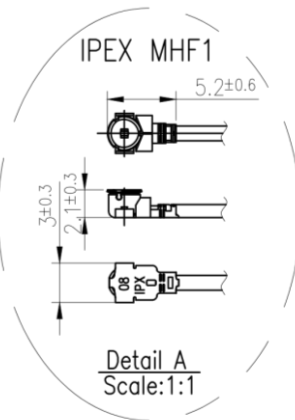
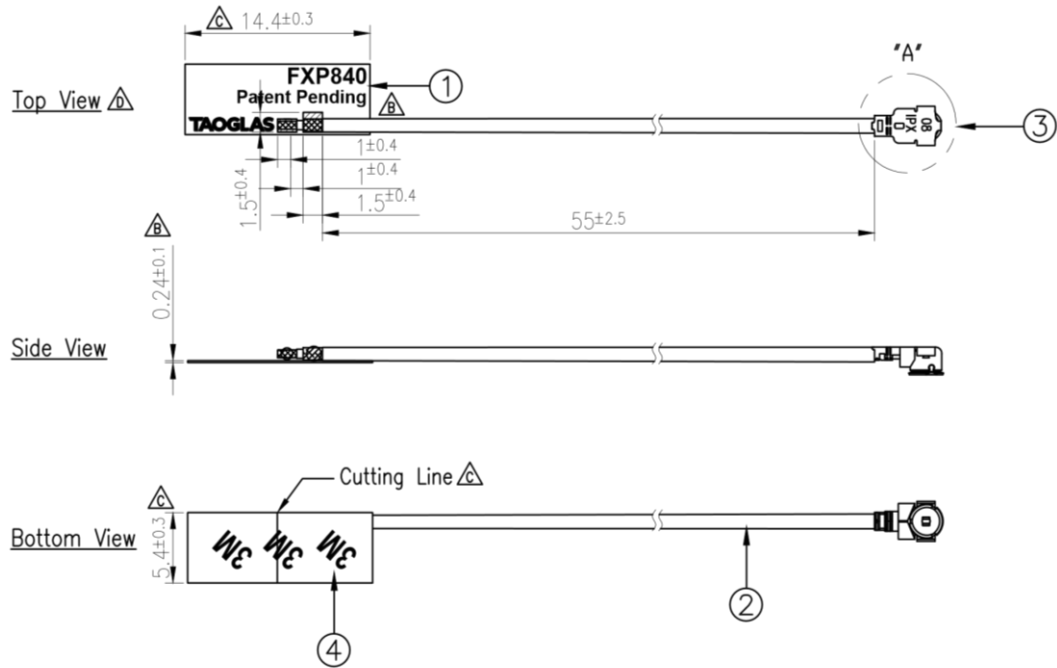

	Name	P/N	Material	Finish	QTY
1	FXP840 FPCB	100112E020011A	Polymer	Black	1
2	0.81 Coaxial Cable	300815C010000A	FEP	Black	1
3	IPEX MHF1	204111E000013A	Brass	Gold	1
4	Double-Sided Adhesive	100112E020011A	3M 467	Brown Liner	1

## 6. Packaging

1pcs FXP840.07.0055B per PE Bag  
 Weight - 1g

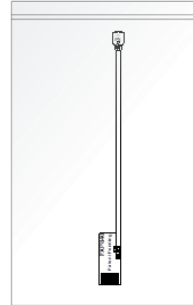

2000pcs FXP840.07.0055B per carton  
 Dimensions - 230\*160\*175mm  
 Weight - 6.8Kg

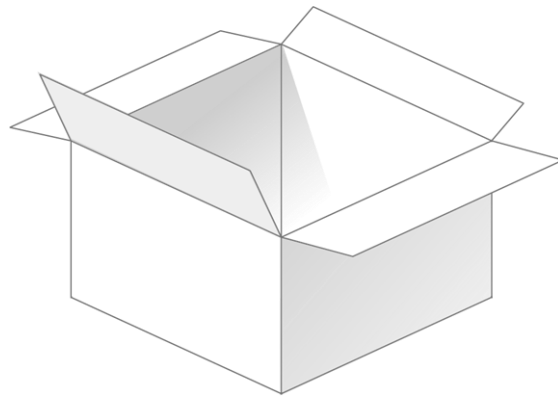

Changelog for the datasheet

**SPE-12-8-115 - FXP840.07.0055B**

**Revision: K (Current Version)**

Date:	2024-02-13
Changes:	Full datasheet update.
Changes Made by:	Gary West

**Previous Revisions**

**Revision: J**

Date:	2020-09-04
Changes:	Updated Wi-Fi 6 info
Changes Made by:	Jack Conroy

**Revision: E**

Date:	2017-03-08
Changes:	Added Note on Intro
Changes Made by:	Aine Doyle

**Revision: I**

Date:	2017-03-08
Changes:	ECR-18-8-259
Changes Made by:	Russell Meyler

**Revision: D**

Date:	2012-11-19
Changes:	Packaging Details Updated
Changes Made by:	Aine Doyle

**Revision: H**

Date:	2018-06-27
Changes:	Updated Peak Gain
Changes Made by:	Jack Conroy

**Revision: C**

Date:	2012-10-02
Changes:	Updated Drawing
Changes Made by:	Aine Doyle

**Revision: G**

Date:	2018-06-27
Changes:	Updated Peak Gain
Changes Made by:	Carol Faughnan

**Revision: B**

Date:	2012-09-27
Changes:	Packaging Details Updated
Changes Made by:	Aine Doyle

**Revision: F**

Date:	2017-05-07
Changes:	PCN-17-8-081
Changes Made by:	Aine Doyle

**Revision: A (Original First Release)**

Date:	2012-09-13
Notes:	
Author:	Technical Writer



[www.taoglas.com](http://www.taoglas.com)







## Looking for pricing, stock, or lifecycle information?

Click below to explore more details on WIN SOURCE:

 [View FXP840.07.0055B on WIN SOURCE](#)

 [Taoglas Limited Information](#)

## Optimize Your Supply Chain with WIN SOURCE Solutions

-  Global Sourcing Solution
-  Obsolete Management
-  Cost Control Management
-  Shortage Management
-  Alternative Solution
-  Excess Inventory Management