



**THE DATASHEET OF  
ECX2-LMV-3CN-100.000-TR**



The ECX2-LMV is SMD LVDS Oscillator with MultiVolt™ capability of 2.375 ~ 3.63 V. Lowest in-class RMS jitter (12 KHz to 20 MHz) sub 50 fs at 156.250 MHz.

Request a Sample

## OPERATING CONDITIONS / ELECTRICAL CHARACTERISTICS

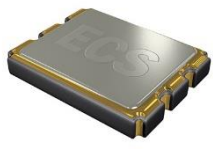
ECX2-LMV LVDS XO	PARAMETERS	CONDITIONS	ECX2-LMV			UNITS
			MIN	TYP	MAX	
	Frequency Range		100.000		320.000	MHz
	* Frequency Stability	-40 ~ +85°C (CN Opt)			±25	ppm
	Supply Voltage		2.375		3.63	V
	Input Current	Pin 1 Open or ViH			24	mA
	Stand-by Current	Pin 1 ViL			30	µA
	Symmetry	@ crossing point		45/55		%
	Rise & Fall time	20% Vdd – 80% Vdd			0.3	nS
	“0” Level	VOL	0.9	+1.10		V
	“1” Level	VOH		+1.43	+1.6	V
	Output Load	LVDS			100	Ω
	Differential Output Voltage		247	330	454	mV
	Differential Output error				50	mV
	Output offset voltage		1.125	1.25	1.375	V
	Output offset error				50	mV
	Start Up Time				10	mS
	Disable delay time				200	ns
	Enable delay time				2	ms
	Aging	1 <sup>st</sup> year			±5	ppm
	RMS Jitter (12 kHz to 20 MHz Band)	@ 156.25 MHz 3.3V		46.8	60	fs
	Operating Temp*	(N Opt)	-40		+85	°C
	Storage Temp		-55		+125	°C

### Features

- Ultra-low jitter: sub 50 fs at 156.25 MHz
- RoHS Compliant
- Tight Stability
- Wide Supply Voltage
- Compatible with +2.5V or +3.3V Power Supply
- Low Power consumption

### Applications

- Networking & communications
- Optical Transceivers
- Fibre Channel
- Ethernet/Gbe/SyncE
- PON
- Test and measurement

## PART NUMBERING GUIDE: Example ECX2-LMV-3CN-156.250-TR

SERIES	Package Size (mm)	Stability	Temp Range	Frequency	PACKAGING
ECX2-LMV LVDS, Ultra Low Jitter MultiVolt™ Oscillator	2 = 2.5 x 2.0 3 = 3.2 x 2.5 5 = 5 x 3.2 7 = 7 x 5	A = ±100 ppm B = ±50 ppm C = ±25 ppm ** D = ±20 ppm	M = -20 ~ +70°C N = -40 ~ +85°C	156.250 MHz	-TR = Tape & Reel

\* Frequency Stability includes initial tolerance, temperature, supply voltage and load change reflow frequency shift.

\*\* Contact ECS for availability over -40 ~ +85°C.

## Typical Phase noise/Jitter

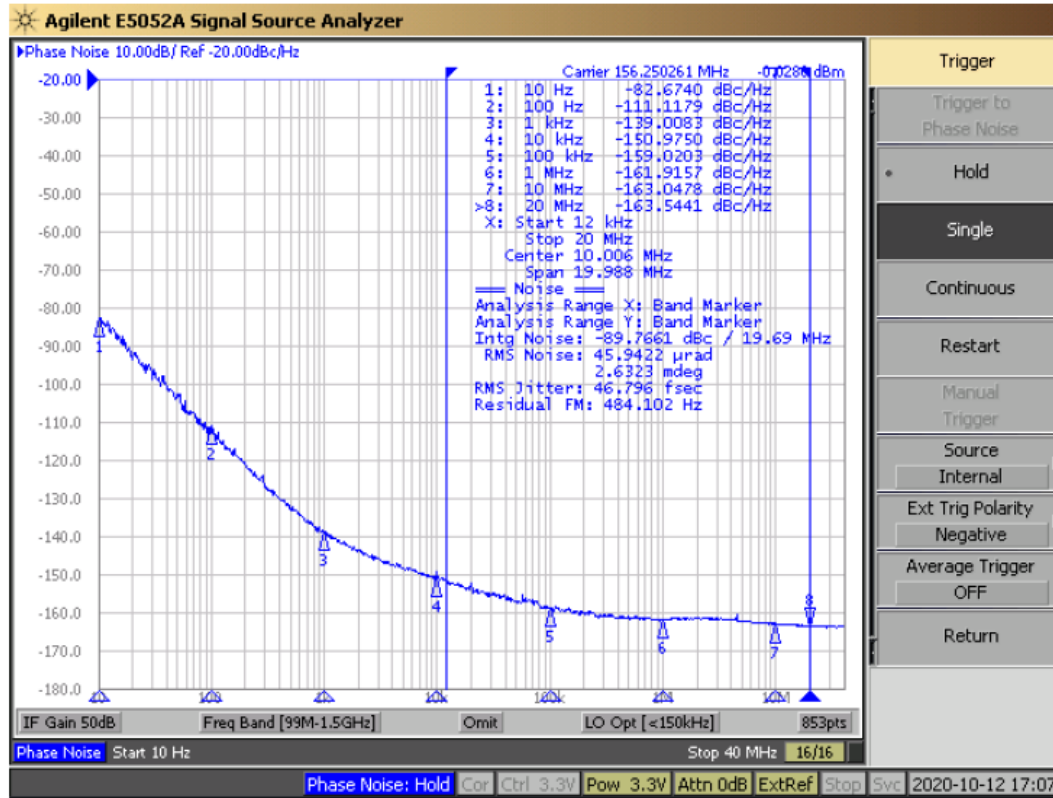

	Frequency (offset)	100.000	125.000	156.250	200.000	285.714	312.500
SSB Phase Noise Data (dBc/Hz typical)	10 Hz	-89.3	-76.7	-82.6	-74.0	-52.57	-45.2
	100 Hz	-118.2	-106.7	-111.1	-103.8	-84.2	-80.2
	1 KHz	-140.3	-135.6	-139.0	-130.7	-118.6	-112.7
	10 KHz	-154.2	-153.5	-150.9	-150.0	-146.4	-142.5
	100 KHz	-160.0	-159.7	-159.0	-158.4	-156.1	-153.8
	1 MHz	-162.6	-162.6	-161.9	-162.6	-160.5	-158.3
	10 MHz	-163.0	-163.0	-163.0	-163.9	-161.9	-159.4
	20 MHz	-163.2	-163.3	-163.5	-164.0	-162.3	-159.7
RMS Phase Jitter 12 KHz ~ 20 MHz		70.9 fs	56.9 fs	46.8 fs	33 fs	29.1 fs	35.2 fs

Table 1) Typical Phase Noise/Jitter

# ECX2-LMV

SMD MultiVolt™ LVDS, low jitter  
Crystal Oscillator



## DIMENSIONS (mm)

2 = 2.5 x 2.0 Pkg

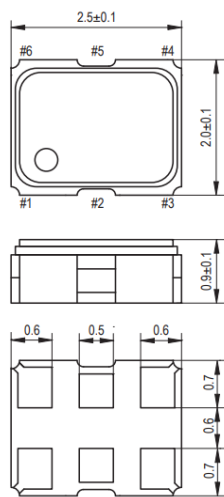

3 = 3.2 x 2.5 Pkg

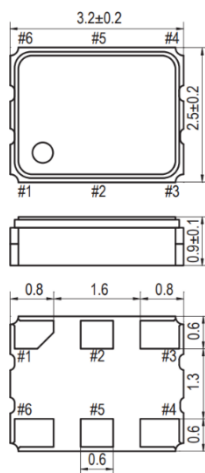

5 = 5 x 3.2 Pkg

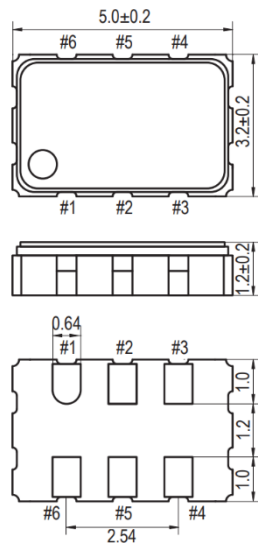

7 = 7 x 5 Pkg

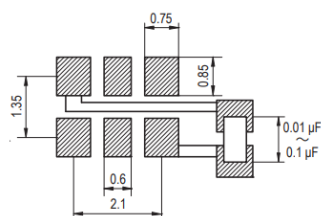
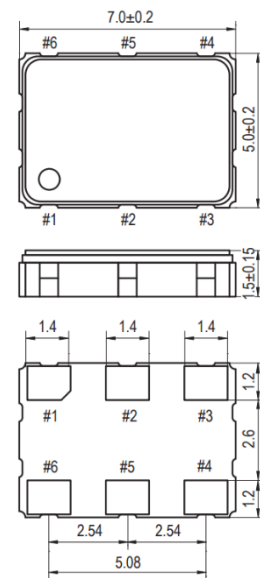

Figure 1) Top, Side, Bottom & Land

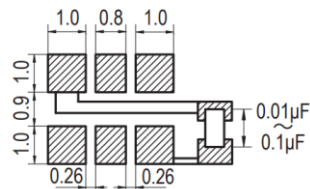

Figure 2) Top, Side, Bottom & Land

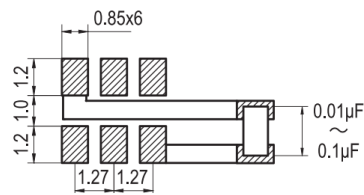

Figure 3) Top, Side, Bottom & Land

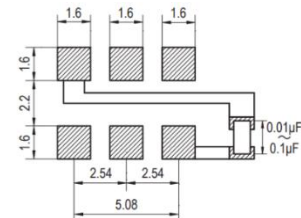

Figure 4) Top, Side, Bottom & Land

PIN	CONNECTIONS	
1	"L"	OPEN or "H"
2		NC
3		Gnd
4	Z	OUTPUT
5	Z	C-OUTPUT
6		VDD

Z : High Impedance

# ECX2-LMV

SMD MultiVolt™ LVDS, low jitter  
Crystal Oscillator

SOLDER PROFILE	
Peak solder Temp	+260°C ±5°C 10 ±5 Sec Max.
	2 Cycles Max.
	MSL 1, Lead Finish Au

Develop Frequencies	
	100.000 MHz
	125.000 MHz
	156.250 MHz
	200.000 MHz
	285.714 MHz
	312.500 MHz

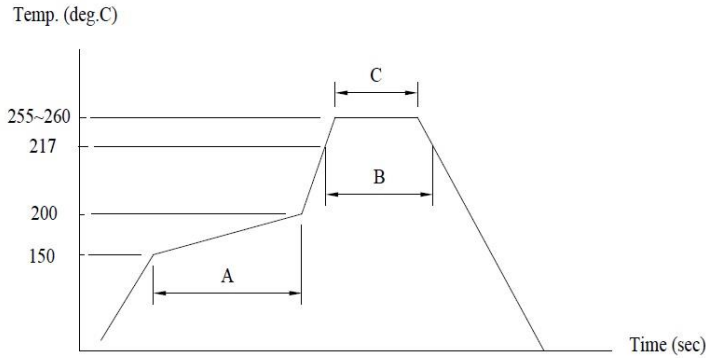

(A)→Preheating area : 150~200°C, 60~120sec.  
 (B)→Heating area : 217°C, 60~150sec.  
 (C)→Peak temperature : 255~260°C, 30sec. Max.  
 Ramp-up rate (217→260°C) : 3°C/sec. Max.  
 Ramp-down rate (260→217°C) : 6°C/sec. Max.  
 Time 25°C→260°C : 480sec. Max.  
 \*Reference JEDEC J-STD-020

Figure 4) Suggested Reflow Profile

## OUTPUT WAVEFORM

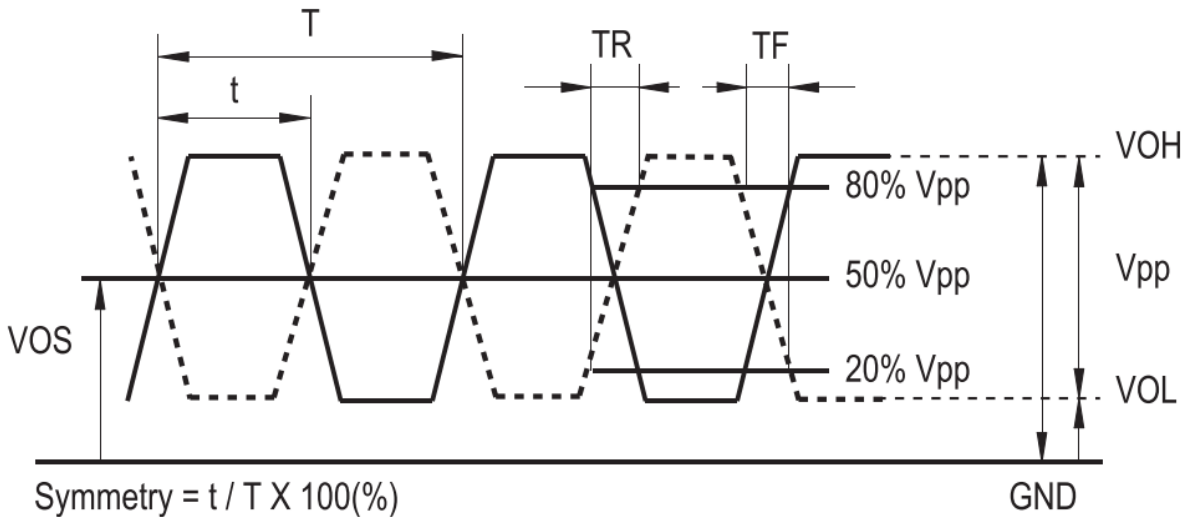

# ECX2-LMV

SMD MultiVolt™ LVDS, low jitter  
Crystal Oscillator



## TEST CIRCUIT

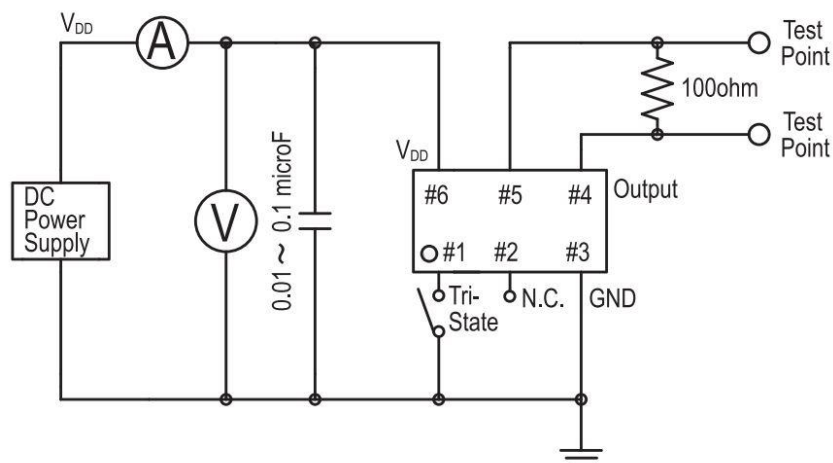

## POCKET TAPE DIMENSIONS (mm)

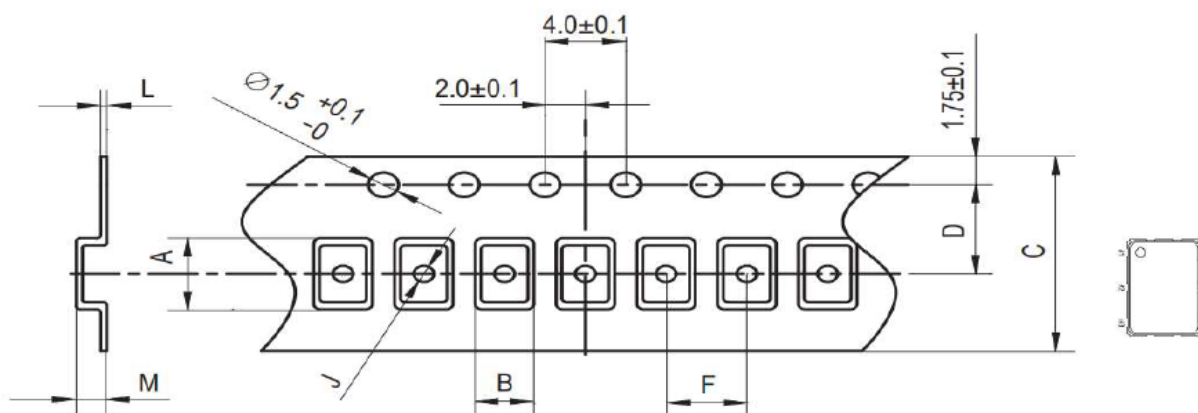

Pkg	A	B	C	D	F	J	L	M	Reel Dia
2.5 x 2.0	2.7	2.3	8.0	3.5	4.0	1.1	0.25	1.1	180 mm
3.2 x 2.5	3.5	2.8	8.0	3.5	4.0	1.0	0.25	1.4	180 mm
5 x 3.2	5.4	3.5	12.0	5.5	8.0	1.5	0.30	1.4	180 mm
7 x 5	7.4	5.4	16.0	7.5	8.0	1.5	0.30	1.9	180 mm

## Looking for pricing, stock, or lifecycle information?

Click below to explore more details on WIN SOURCE:

 [View ECX2-LMV-3CN-100.000-TR on WIN SOURCE](#)

 [ECS Inc. Information](#)

## Optimize Your Supply Chain with WIN SOURCE Solutions

-  Global Sourcing Solution
-  Obsolete Management
-  Cost Control Management
-  Shortage Management
-  Alternative Solution
-  Excess Inventory Management